

M3H Group(1)
Application Note
32-bit Timer Event Counter
(T32A-B)
Programmable Pulse Output Function

Outlines

This application note is a reference material for developing products using the programmable pulse output (PPG) function in the 32-bit timer event counter (T32A) of M3H Group(1).
This document helps the user check operation of the product and develop its program.

Target sample program: Timer_PPG

Table of Contents

Outlines	1
Table of Contents	2
1. Preface	3
2. Reference Document	3
3. Function to Use	4
4. Target Device	4
5. Operation Confirmation Condition	5
6. Evaluation Board Setting	6
7. Operation of Evaluation Board	6
8. Outline of Timer Event Counter (T32A) Function	7
9. Sample Program	8
9.1. Initialization	8
9.2. Sample Program Main Operation	9
9.3. Output Example of Sample Program	10
9.3.1. Setting Example of Terminal Software	10
9.4. Duty Setting Change	11
9.5. Operating Flow of Sample Program	12
10. Precaution	19
11. Revision History	19
RESTRICTIONS ON PRODUCT USE	20

1. Preface

This sample program executes to start the PPG output of the timer function when the PN1 Push Switch is pushed down.

When the PN2 Push Switch is pushed down, the PPG output stops. And the duty rate is changed to 10 %, 25 %, 50 %, 75%, or 90%, one after the other, by the push-down.

Structure diagram of Sample program

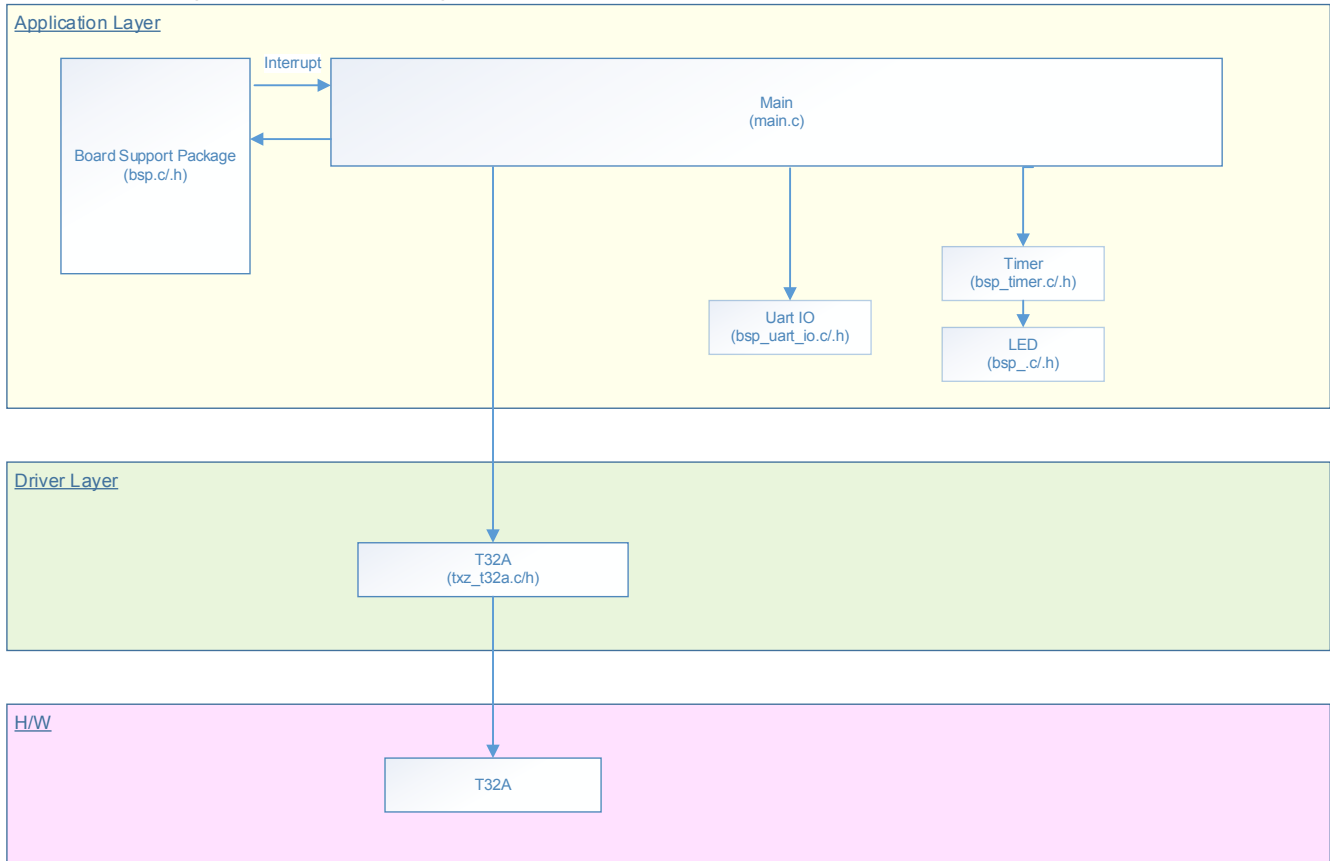

2. Reference Document

- Datasheet
TMPM3H group (1) datasheet Rev2.0 (Japanese edition)
- Reference manual
32-bit timer/event counter (T32A-B) Rev2.1 (Japanese edition)
- Other reference document
TMPM3H(1) Group Peripheral Driver User Manual (Doxygen)

3. Function to Use

IP	Channel	Port	Function/Operation mode
32-bit timer event counter	Timer A ch3	PJ0 (T32A03OUTA)	PPG operation
	Timer A ch0	-	Timer interrupt
Input or output port	-	PN1 (Input Port) PN2 (Input Port)	Input
Asynchronous serial communication circuit	ch0	PA1 (UT0TXDA) PA2(UT0RXD)	Asynchronous communication with PC

4. Target Device

The target devices of application note are as follows.

TMPM3H6FWFG	TMPM3H6FUFG	TMPM3H6FSFG
TMPM3H6FWDFG	TMPM3H6FUDFG	TMPM3H6FSDFG
TMPM3H5FWFG	TMPM3H5FUFG	TMPM3H5FSFG
TMPM3H5FWDFG	TMPM3H5FUDFG	TMPM3H5FSDFG
TMPM3H4FWUG	TMPM3H4FUUG	TMPM3H4FSUG
TMPM3H4FWFG	TMPM3H4FUFG	TMPM3H4FSFG
TMPM3H3FWUG	TMPM3H3FUUG	TMPM3H3FSUG
TMPM3H2FWDUG	TMPM3H2FUDUG	TMPM3H2FSDFG
TMPM3H2FWQG	TMPM3H2FUQG	TMPM3H2FSQG
TMPM3H1FWUG	TMPM3H1FUUG	TMPM3H1FSUG
TMPM3H1FPUG	TMPM3H0FSDUG	TMPM3H0FMDUG

* This sample program operates on the evaluation board of TMPM3H6FWFG.

If other function than the TMPM3H6 one is checked, it is necessary that CMSIS Core related files (C startup file and I/O header file) should be changed properly.

The BSP related file is dedicated to the evaluation board (TMPM3H6). If other function than the TMPM3H6 one is checked, the BSP related file should be changed properly.

5. Operation Confirmation Condition

Used microcontroller	TMPM3H6FWFG
Used board	TMPM3H6FWFG Evaluation Board (Product of Sensyset)
Unified development environment	IAR Embedded Workbench for ARM 8.11.2.13606
Unified development environment	µVision MDK Version 5.24.2.0
Terminal software	Tera Term V4.96
Sample program	V1100

Evaluation board (TMPM3H6FWFG Evaluation Board) (Top view)

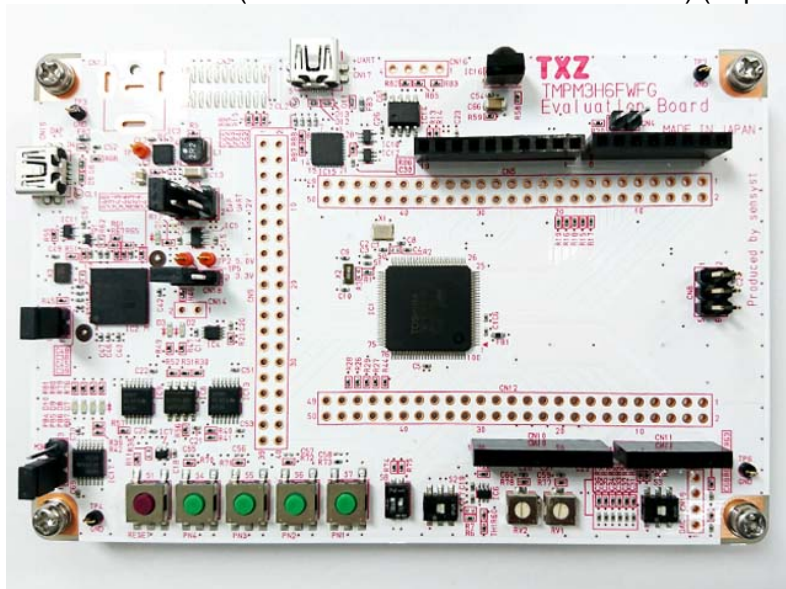

For purchasing the board, refer to the following homepage. (<http://www.chip1stop.com/>)

6. Evaluation Board Setting

The following pin connections should be done on the evaluation board.

CN5		
Use	Through-hole No.	Setting
UART (RXD)	9-10	Connection
UART (TXD)	11-12	Connection

CN9		
Use	Through-hole No.	Setting
Push SW (S6)	23-24	Connection
Push SW (S7)	25-26	Connection

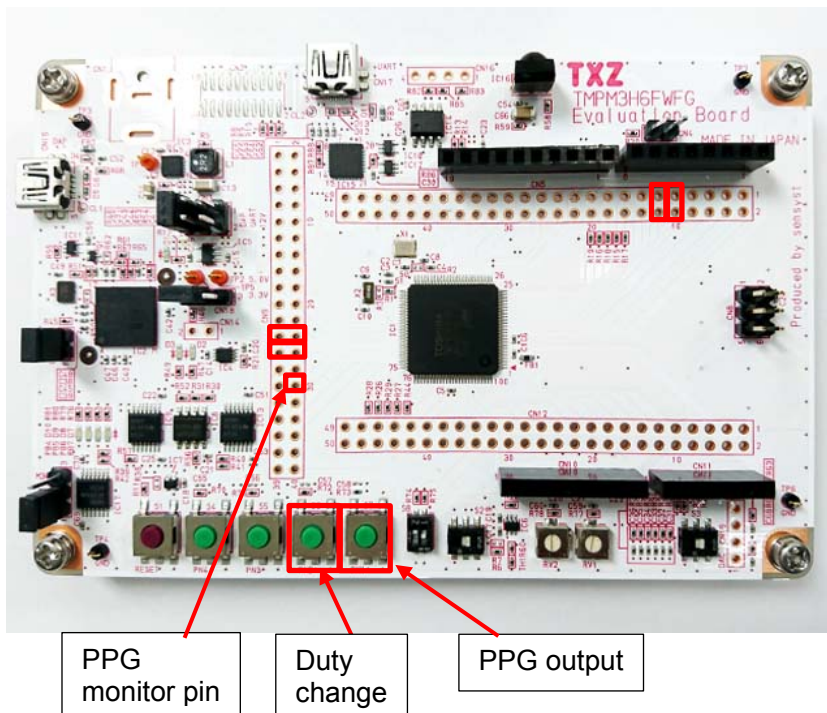

7. Operation of Evaluation Board

PPG output and duty ratio can be switch with Push Switch.

Key	Function
S7 (PN1)	PPG output
S6 (PN2)	Duty change

The duty ratios preset in this sample program are 10 %, 25 %, 50 %, 75 %, and 90 %.
The PPG output can be monitored at PJ0 (T32A03OUTA). (It can be monitored at CN9: 30 pin.)

8. Outline of Timer Event Counter (T32A) Function

T32A is composed two 16-bit timer that can be used Timer A and Timer B. Also it can use Timer C that is connected Timer A and Timer B as 32-bit timer. When use Timer C, Timer A and Timer B cannot be used.

The T32A have an interval timer, event counter, input capture, 2-phase counter input, PPG output, Synchronous Start, and Trigger start/stop function.

The timer has the following functions;

16-bit timer: Timer A and Timer B

32-bit timer: Timer C

9. Sample Program

When Low input is detected at PortN1, the PPG output starts.

When Low input is detected at PortN2, the PPG output stops. And the duty ratio is changed.

The terminal software can display the duty ratio value.

The pulse width has been set to 500 μ s in this sample program.

5 values are defined for the duty ratio of the PPG output (50 μ s, 125 μ s, 250 μ s, 375 μ s, and 450 μ s)

Those values generate 5 duty ratios, 10 %, 25 %, 50 %, 75 %, and 90 %, respectively.

9.1. Initialization

The following initialization is done after power is supplied.

The initialization of each clock setting is done.

The duty ratio of the PPG output is set after System clock setting.

Then, the GPIO setting is done.

Perform initialization setting of PORT for pulse output.

Timer A ch0 is initialized for the timer driver setting.

Timer A ch3 is initialized for the pulse driver setting.

9.2. Sample Program Main Operation

The timer setting is done to use the timer for PPG operation.
 Timer A ch0 has been selected for Switch polling in this sample program.
 1-ms timer interrupt checks Switch status.
 Timer A ch3 has been selected as the timer for the output pulse.

When the value in Timer A counter matches the values in Timer registers (**[T32AxRGA0]** and **[T32AxRGA1]**), the timer output is set or cleared, respectively, which a pulse with an arbitrary width can be generated.
 And it is output from T32A03OUTA pin.

The setting condition can be displayed by the terminal software.
 UART setting should be done, and the setting condition is displayed.

The following is an example of the output signal with 25-% duty.

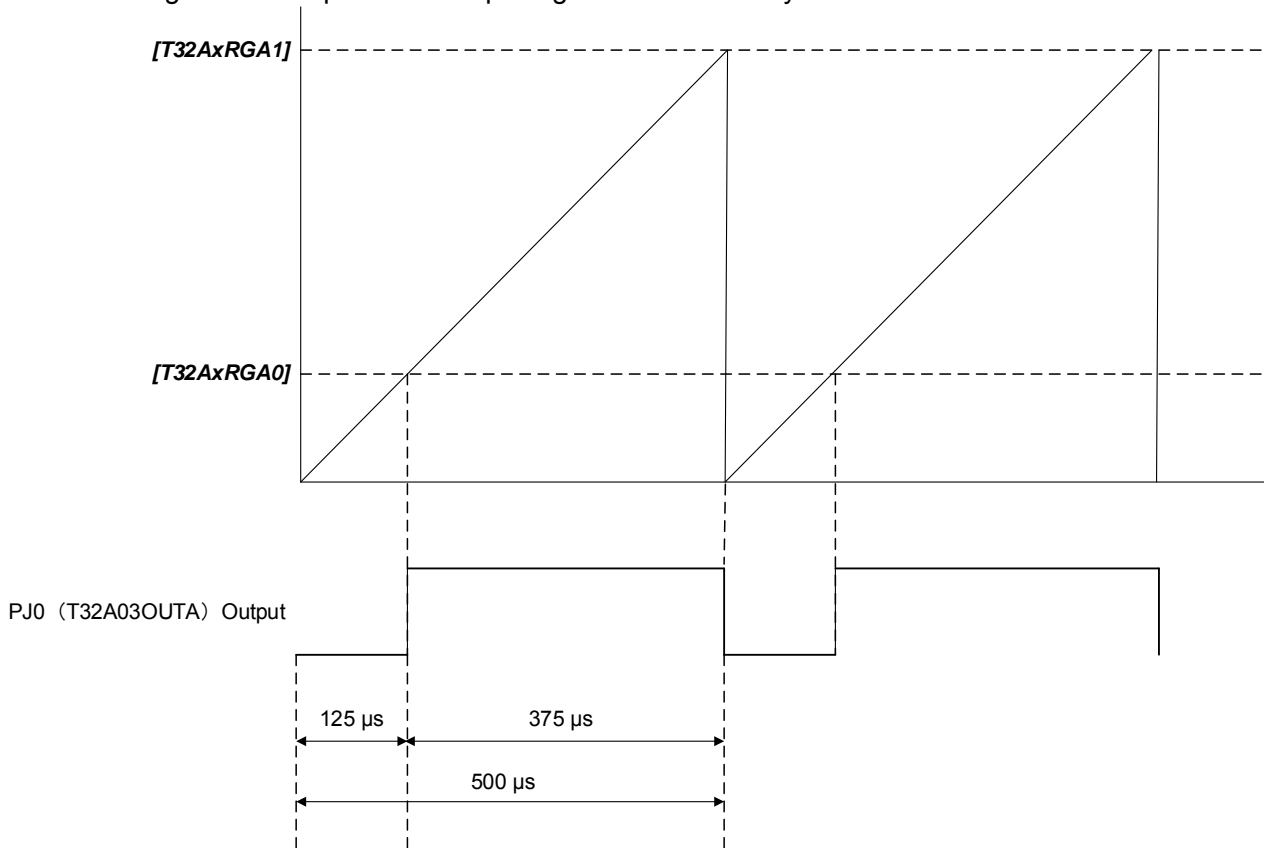

9.3. Output Example of Sample Program

```
PPG Output  
Duty: 10%  
Change to Duty: 25%  
Change to Duty: 50%  
Change to Duty: 75%  
Change to Duty: 90%  
PPG Output  
Duty: 90%  
Change to Duty: 10%  
PPG Output  
Duty: 10%
```

9.3.1. Setting Example of Terminal Software

The operation of the terminal software (Tera Term) has been checked with the following settings.

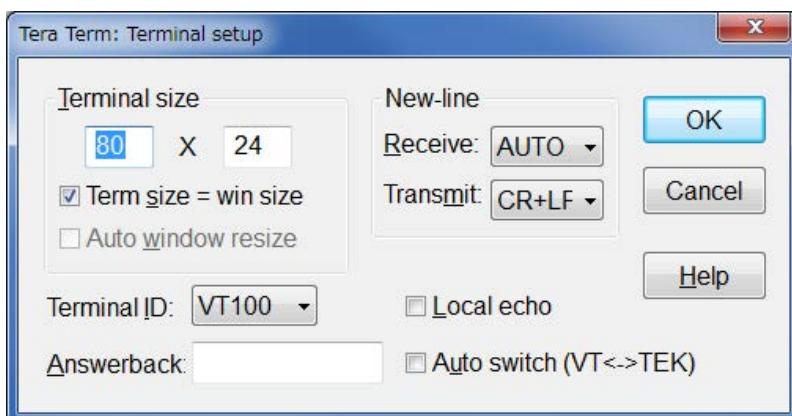
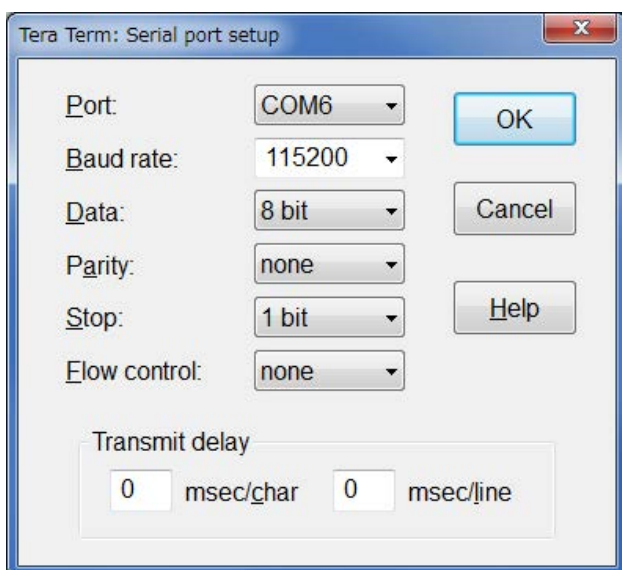

9.4. Duty Setting Change

When the duty is changed, the following setting should be modified.
static uint32_t tgtRisingTiming[5U] = { 10U, 25U, 50U, 75U, 90U };
5 values are available from 10 % to 90 % in the above setting.

For example, 10 % duty is calculated by the following formula;
Pulse width setting;

p_pulse->init.pulse_trailing = 500U;
500- μ s pulse width is defined above.

Duty setting;

RisingTimingus[i] = tgtRisingTiming[i] * 5U;

The rising time is set above.

The duty ratios of 10 %, 25 %, 50 %, 75 %, and 90 % are defined in tgtRisingTiming[i].

The rising times are calculated to 50, 125, 250, 375, and 450 μ s, respectively.

The pulse width is supposed to be 500 μ s to calculate the duty ratios.

If the duty ratio is changed, the corresponding set value should be changed in the following.

static uint32_t tgtRisingTiming[5U] = { 10U, 25U, 50U, 75U, 90U };

9.5. Operating Flow of Sample Program

The operating flows of the sample program are shown as follows.

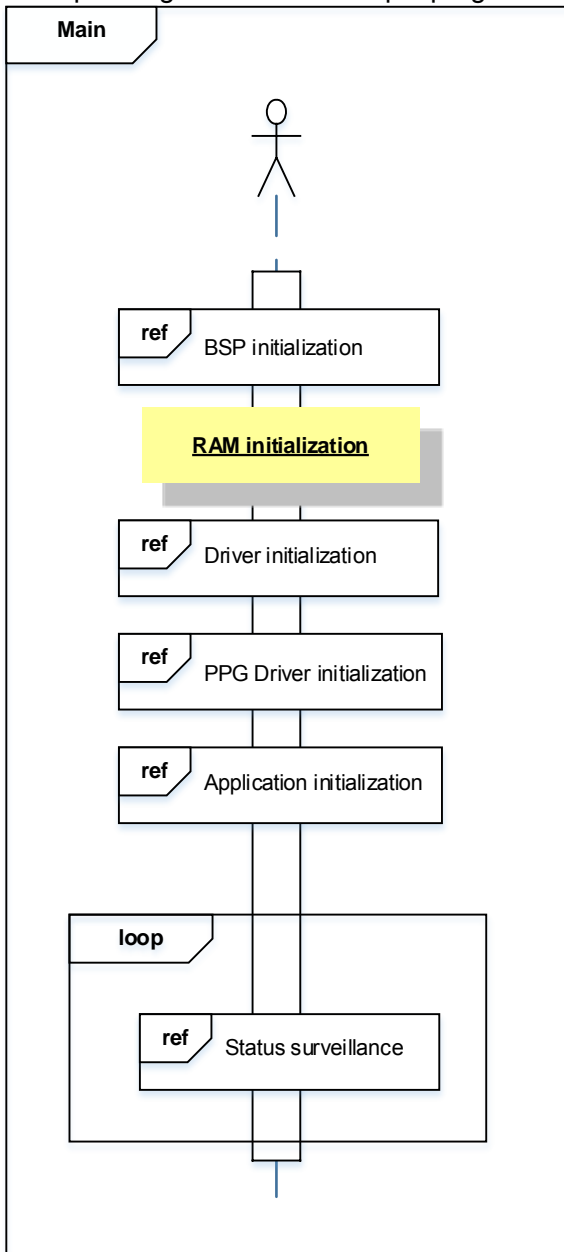

Driver initialization

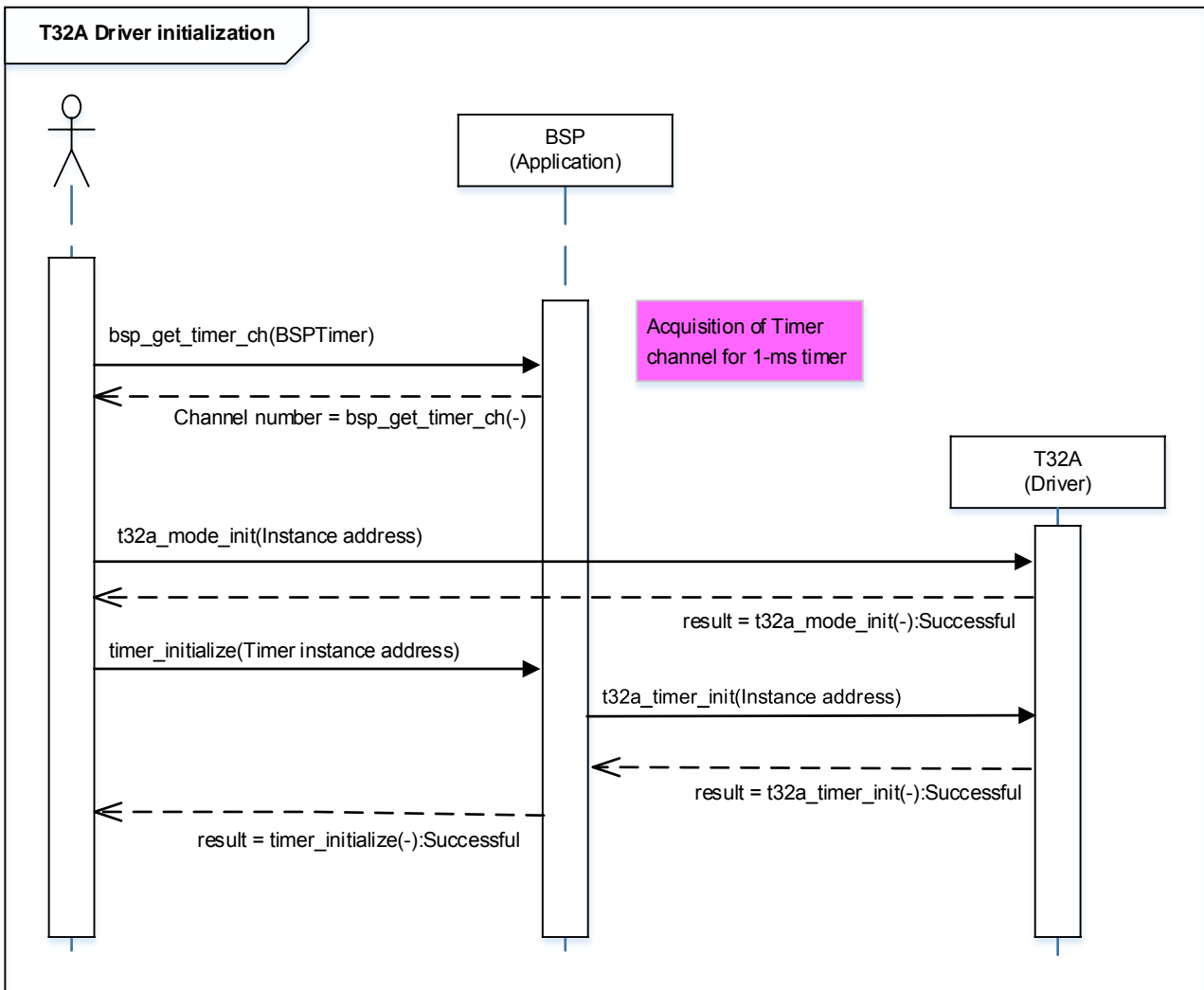
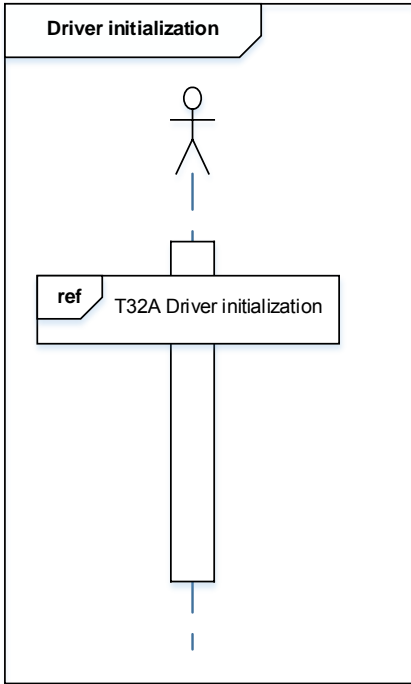

PPG Driver initialization

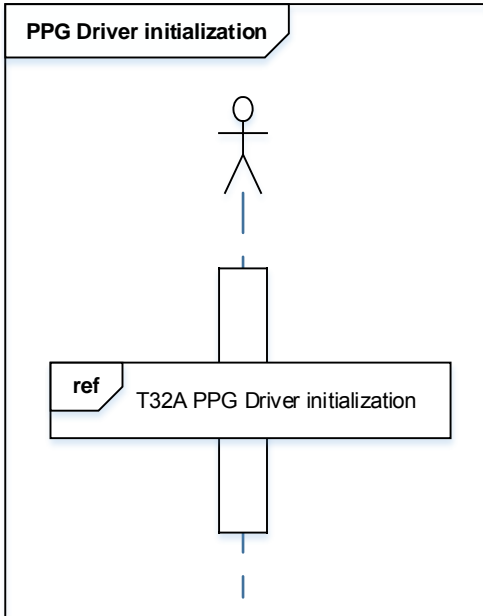

T32A PPG Driver initialization

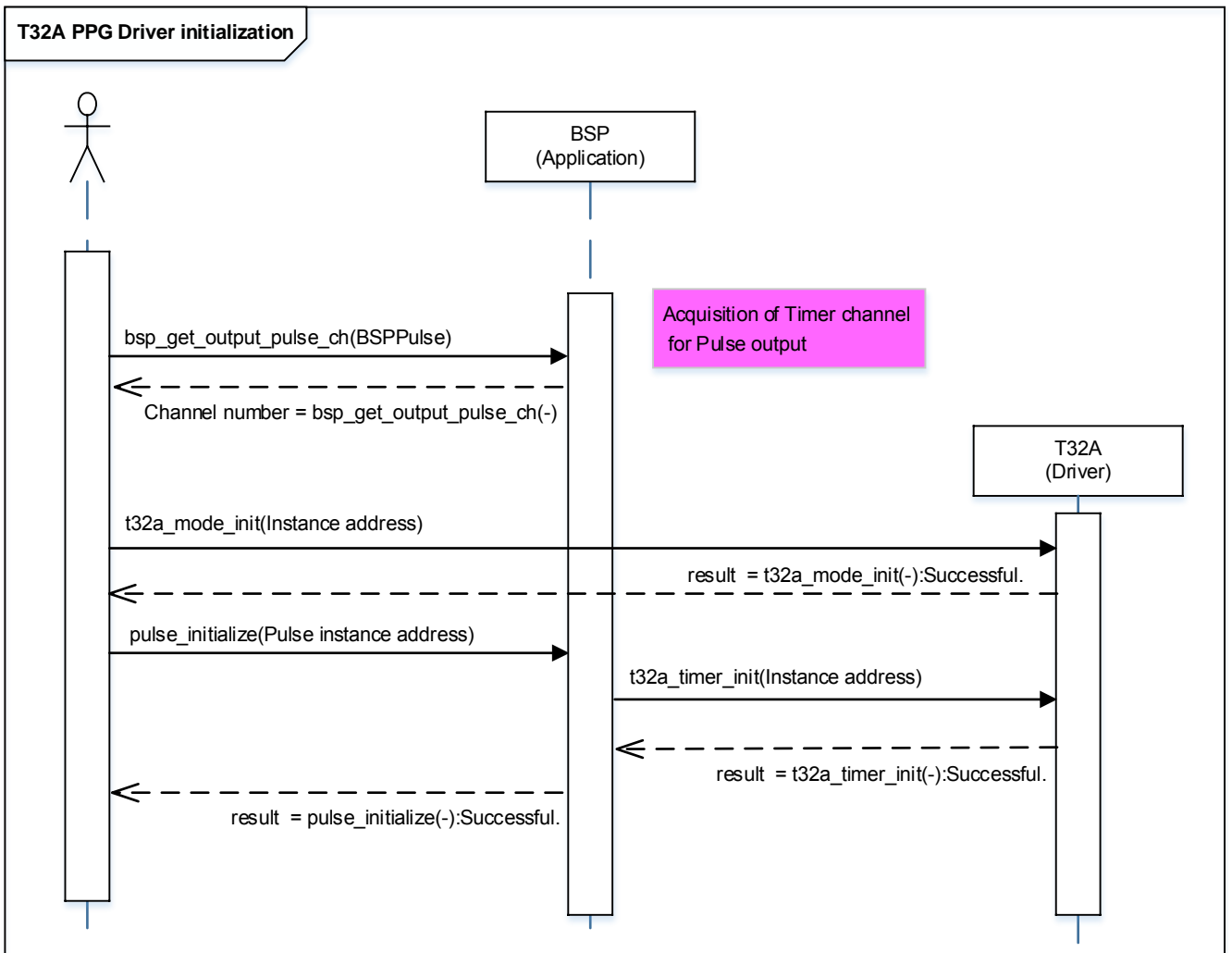

Application initialization

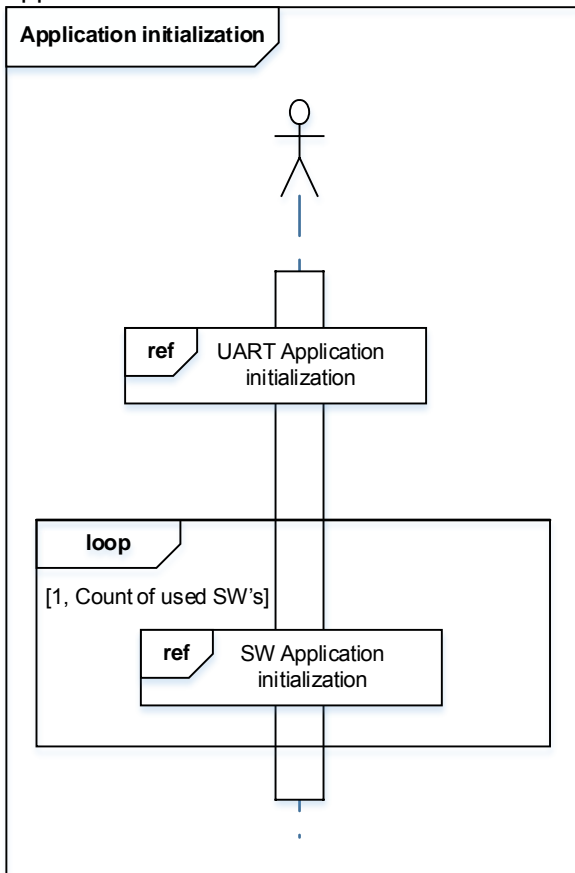

SW Application initialization

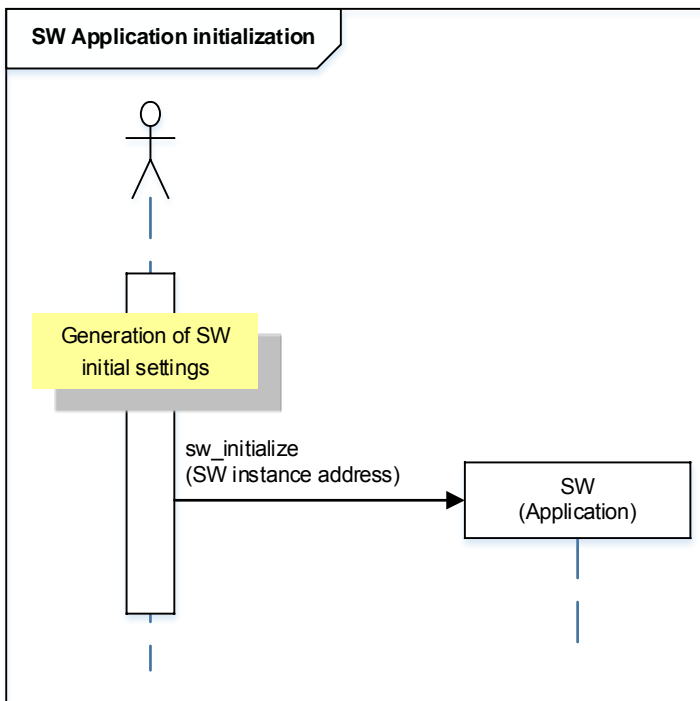

Condition monitoring

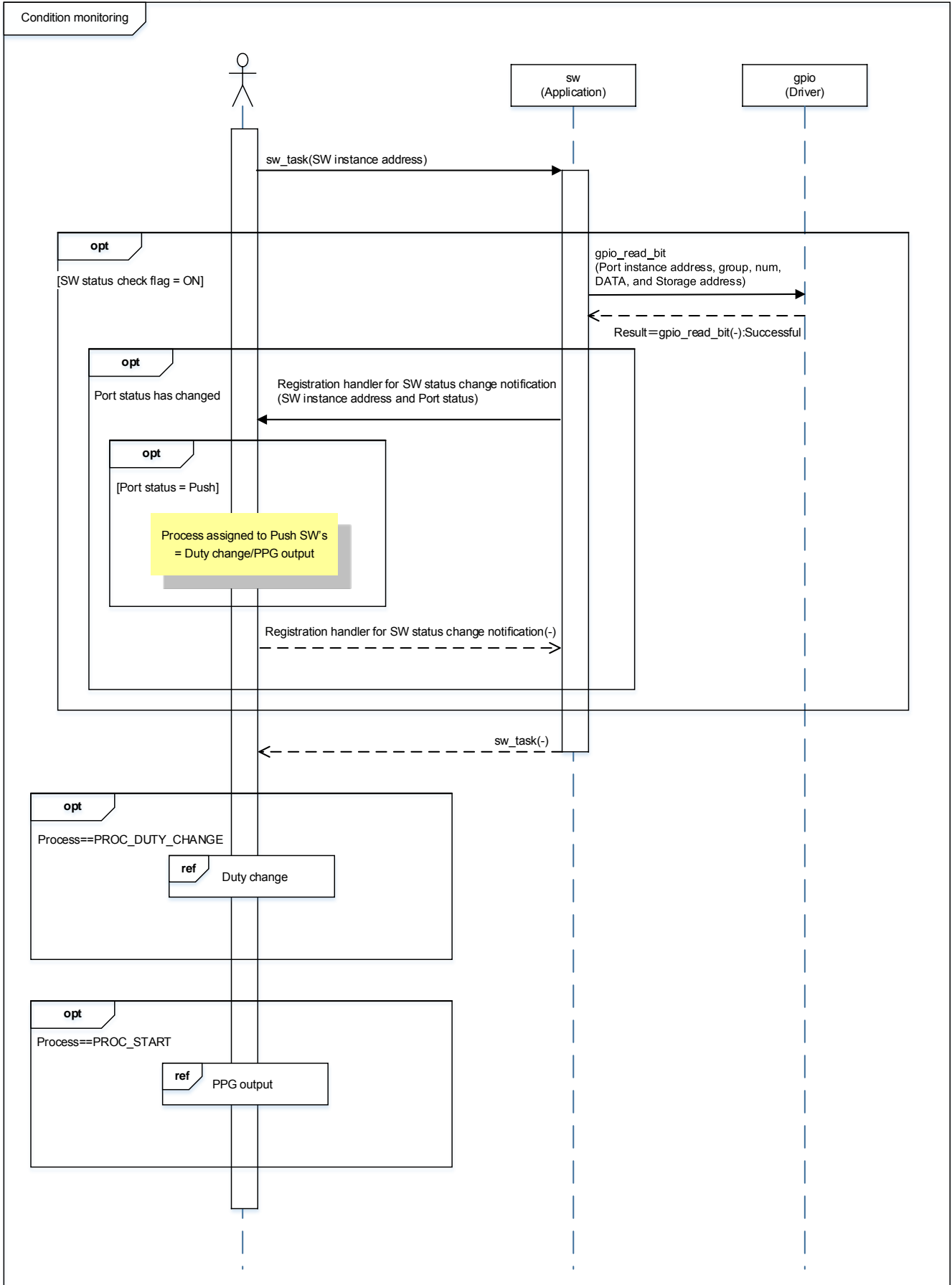

Duty change

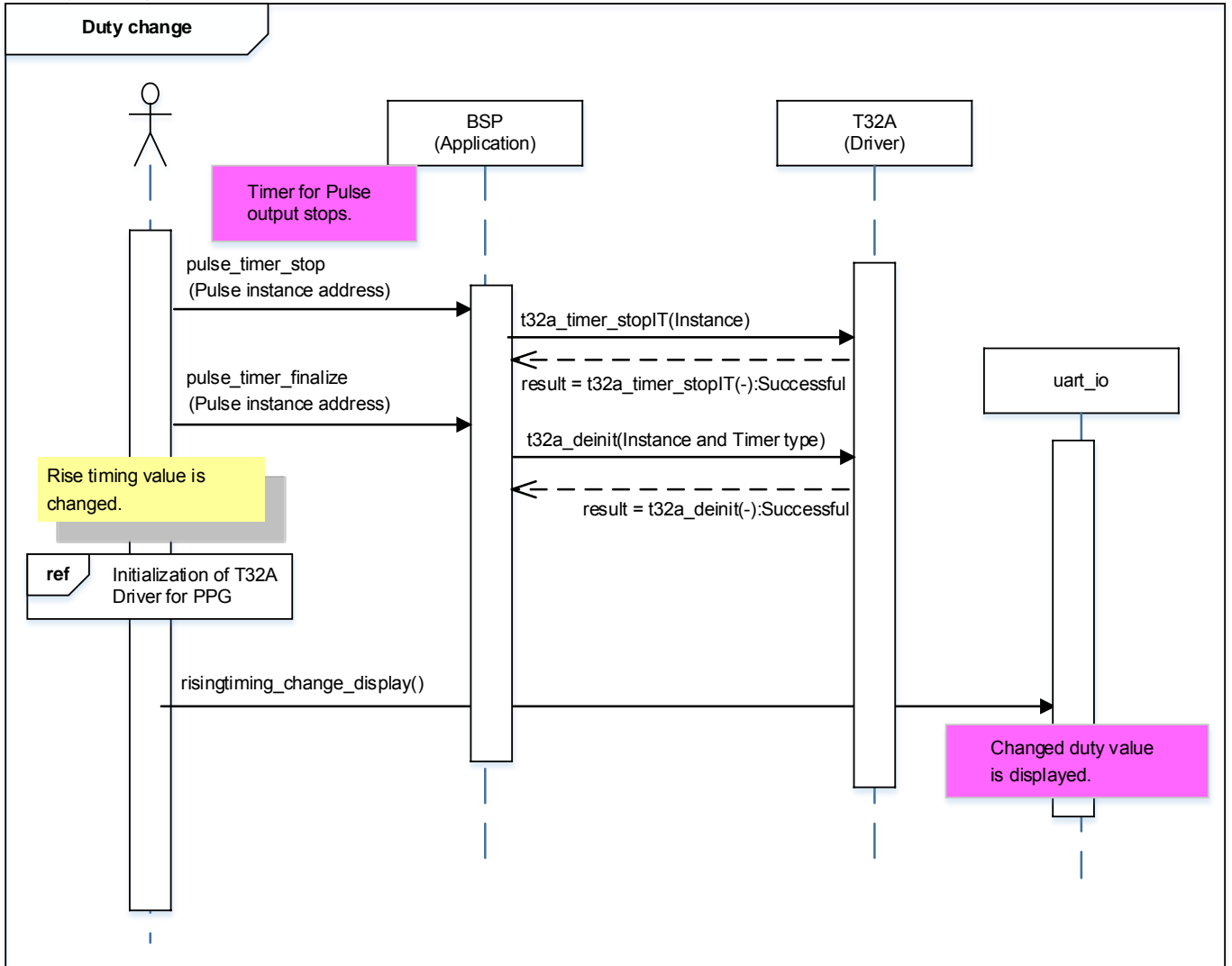

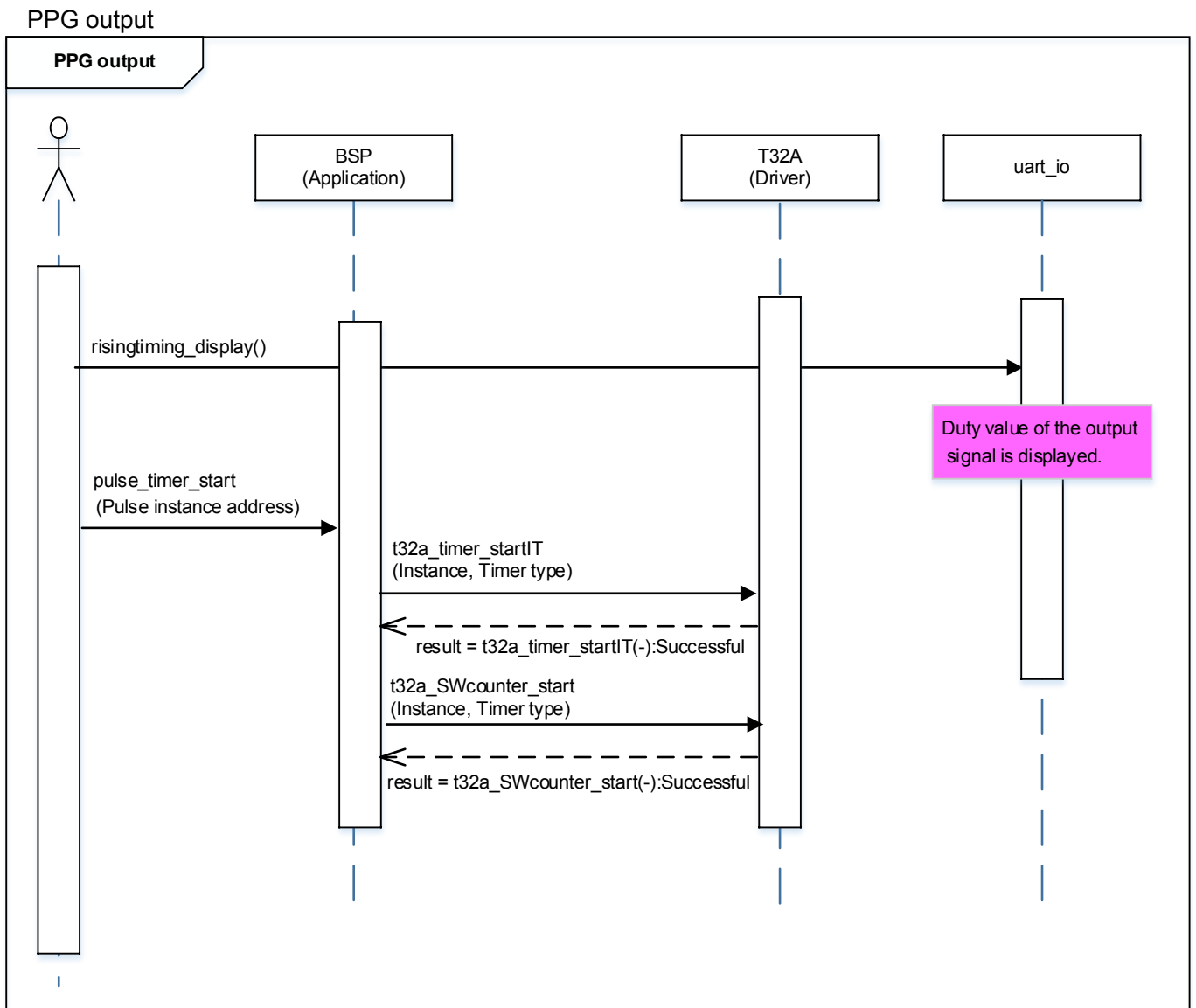

10. Precaution

When using the sample program with CPU other than TPM3H6, please check operation sufficiently.

11. Revision History

Rev	Date	Page	Description
1.0	2018-03-09	-	First release

RESTRICTIONS ON PRODUCT USE

Toshiba Corporation and its subsidiaries and affiliates are collectively referred to as "TOSHIBA". Hardware, software and systems described in this document are collectively referred to as "Product".

- TOSHIBA reserves the right to make changes to the information in this document and related Product without notice.
- This document and any information herein may not be reproduced without prior written permission from TOSHIBA. Even with TOSHIBA's written permission, reproduction is permissible only if reproduction is without alteration/omission.
- Though TOSHIBA works continually to improve Product's quality and reliability, Product can malfunction or fail. Customers are responsible for complying with safety standards and for providing adequate designs and safeguards for their hardware, software and systems which minimize risk and avoid situations in which a malfunction or failure of Product could cause loss of human life, bodily injury or damage to property, including data loss or corruption. Before customers use the Product, create designs including the Product, or incorporate the Product into their own applications, customers must also refer to and comply with (a) the latest versions of all relevant TOSHIBA information, including without limitation, this document, the specifications, the data sheets and application notes for Product and the precautions and conditions set forth in the "TOSHIBA Semiconductor Reliability Handbook" and (b) the instructions for the application with which the Product will be used with or for. Customers are solely responsible for all aspects of their own product design or applications, including but not limited to (a) determining the appropriateness of the use of this Product in such design or applications; (b) evaluating and determining the applicability of any information contained in this document, or in charts, diagrams, programs, algorithms, sample application circuits, or any other referenced documents; and (c) validating all operating parameters for such designs and applications. **TOSHIBA ASSUMES NO LIABILITY FOR CUSTOMERS' PRODUCT DESIGN OR APPLICATIONS.**
- **PRODUCT IS NEITHER INTENDED NOR WARRANTED FOR USE IN EQUIPMENTS OR SYSTEMS THAT REQUIRE EXTRAORDINARILY HIGH LEVELS OF QUALITY AND/OR RELIABILITY, AND/OR A MALFUNCTION OR FAILURE OF WHICH MAY CAUSE LOSS OF HUMAN LIFE, BODILY INJURY, SERIOUS PROPERTY DAMAGE AND/OR SERIOUS PUBLIC IMPACT ("UNINTENDED USE").** Except for specific applications as expressly stated in this document, Unintended Use includes, without limitation, equipment used in nuclear facilities, equipment used in the aerospace industry, medical equipment, equipment used for automobiles, trains, ships and other transportation, traffic signaling equipment, equipment used to control combustions or explosions, safety devices, elevators and escalators, devices related to electric power, and equipment used in finance-related fields. **IF YOU USE PRODUCT FOR UNINTENDED USE, TOSHIBA ASSUMES NO LIABILITY FOR PRODUCT.** For details, please contact your TOSHIBA sales representative.
- Product shall not be used for or incorporated into any products or systems whose manufacture, use, or sale is prohibited under any applicable laws or regulations.
- The information contained herein is presented only as guidance for Product use. No responsibility is assumed by TOSHIBA for any infringement of patents or any other intellectual property rights of third parties that may result from the use of Product. No license to any intellectual property right is granted by this document, whether express or implied, by estoppel or otherwise.
- **ABSENT A WRITTEN SIGNED AGREEMENT, EXCEPT AS PROVIDED IN THE RELEVANT TERMS AND CONDITIONS OF SALE FOR PRODUCT, AND TO THE MAXIMUM EXTENT ALLOWABLE BY LAW, TOSHIBA (1) ASSUMES NO LIABILITY WHATSOEVER, INCLUDING WITHOUT LIMITATION, INDIRECT, CONSEQUENTIAL, SPECIAL, OR INCIDENTAL DAMAGES OR LOSS, INCLUDING WITHOUT LIMITATION, LOSS OF PROFITS, LOSS OF OPPORTUNITIES, BUSINESS INTERRUPTION AND LOSS OF DATA, AND (2) DISCLAIMS ANY AND ALL EXPRESS OR IMPLIED WARRANTIES AND CONDITIONS RELATED TO SALE, USE OF PRODUCT, OR INFORMATION, INCLUDING WARRANTIES OR CONDITIONS OF MERCHANTABILITY, FITNESS FOR A PARTICULAR PURPOSE, ACCURACY OF INFORMATION, OR NONINFRINGEMENT.**
- Do not use or otherwise make available Product or related software or technology for any military purposes, including without limitation, for the design, development, use, stockpiling or manufacturing of nuclear, chemical, or biological weapons or missile technology products (mass destruction weapons). Product and related software and technology may be controlled under the applicable export laws and regulations including, without limitation, the Japanese Foreign Exchange and Foreign Trade Law and the U.S. Export Administration Regulations. Export and re-export of Product or related software or technology are strictly prohibited except in compliance with all applicable export laws and regulations.
- Please contact your TOSHIBA sales representative for details as to environmental matters such as the RoHS compatibility of Product. Please use Product in compliance with all applicable laws and regulations that regulate the inclusion or use of controlled substances, including without limitation, the EU RoHS Directive. **TOSHIBA ASSUMES NO LIABILITY FOR DAMAGES OR LOSSES OCCURRING AS A RESULT OF NONCOMPLIANCE WITH APPLICABLE LAWS AND REGULATIONS.**