

TCR5BM series

500 mA CMOS Ultra Low Dropout Regulator

1. Description

The TCR5BM series are CMOS single-output voltage regulators with an on/off control input, featuring ultra low dropout voltage, high PSRR, low inrush current and fast load transient response.

A differentiating feature is the use of a secondary bias rail as a reference voltage that allows ultra low dropout of 100 mV (Typ.) at $I_{OUT} = 500$ mA (1.1 V output, $V_{BIAS} = 3.3$ V).

These voltage regulators are available in fixed output voltages between 0.8 V and 3.6 V, and capable of driving up to 500 mA. Other features include overcurrent protection, thermal shutdown, and Auto-discharge.

The TCR5BM series are offered in the ultra small plastic mold package DFN5B (1.2 mm x 1.2 mm; t 0.38 mm).

As small ceramic input and output capacitors can be used with the TCR5BM series, these devices are ideal for portable applications that require high-density board assembly such as cellular phones.

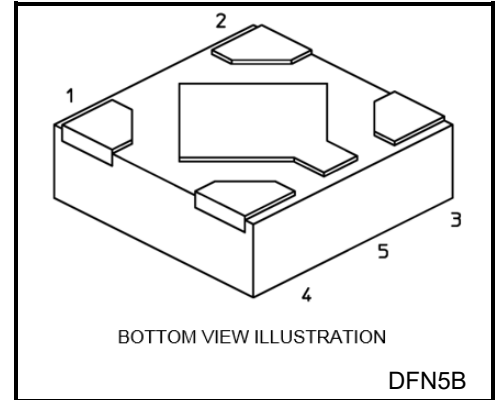

Weight : 1.4 mg (Typ.)

2. Application

Power IC developed for portable applications

3. Features

- Low dropout voltage
 $V_{DO} = 100$ mV (Typ.) at 1.1 V output, $V_{BIAS} = 3.3$ V, $I_{OUT} = 500$ mA
- Low stand-by current ($I_{BIAS(OFF)} = 1$ μ A (Max))
- Low quiescent bias current ($I_{BIAS(ON)} = 19$ μ A (Typ.) at $V_{BIAS} = 5.3$ V, $I_{OUT} = 0$ mA)
- Wide range output voltage line up $V_{OUT} = 0.8$ to 3.6 V
- Overcurrent protection
- Thermal shutdown
- Inrush current reduction
- Under voltage lockout (TCR5BMxxA products)
- Auto-discharge
- Pull down connection between CONTROL and GND
- Ultra small package DFN5B (1.2 mm x 1.2 mm ; t 0.38 mm)

Start of commercial production
2018-08

4. Absolute Maximum Ratings (Ta = 25 °C)

Characteristics	Symbol	Rating	Unit
Bias voltage	V _{BIAS}	-0.3 to 6.0	V
Input voltage	V _{IN}	-0.3 to 6.0	V
Control voltage	V _{CT}	-0.3 to 6.0	V
Output voltage	V _{OUT}	-0.3 to V _{IN} + 0.3 ≤ 6.0	V
Power dissipation	P _D	600 (Note 1)	mW
Junction temperature	T _j	-40 to 150	°C
Storage temperature range	T _{stg}	-55 to 150	°C

Note: Using continuously under heavy loads (e.g. the application of high temperature/current/voltage and the significant change in temperature, etc.) may cause this product to decrease in the reliability significantly even if the operating conditions (i.e. operating temperature/current/voltage, etc.) are within the absolute maximum ratings and the operating ranges.

Please design the appropriate reliability upon reviewing the Toshiba Semiconductor Reliability Handbook (“Handling Precautions”/“Derating Concept and Methods”) and individual reliability data (i.e. reliability test report and estimated failure rate, etc).

Note 1: Rating at mounting on a board
 (Glass epoxy board dimension : 40 mm x 40 mm (4layer), t = 1.8 mm
 Metal pattern ratio : approximately 70 % each layer)

5. Operating Ranges

Characteristics	Symbol	Rating	Unit
Bias voltage	V _{BIAS}	(V _{OUT} + 1.4 ≥ 2.5) to 5.5	V
Input voltage	V _{IN}	V _{OUT} + V _{DO} to V _{BIAS}	V
Control voltage	V _{CT}	0 to V _{BIAS}	V
Output voltage	V _{OUT}	0.8 to 3.6	V
Output current	I _{OUT}	0 to 0.5 (Note 2)	A
Operation Temperature	T _{opr}	-40 to 85	°C
CO _{UT}	C _{OUT}	≥ 2.2 μF	—
C _{IN}	C _{IN}	≥ 1.0 μF	—
C _{BIAS}	C _{BIAS}	≥ 0.1 μF	—

Note 2: Do not operate at or near the maximum ratings of operating ranges for extended periods of time. Exposure to such conditions may adversely impact product reliability and results in failures not covered by warranty.

Maximum operating ranges output current specification defined as lifetime average junction temperature of +45 °C where max rated DC current = lifetime average current to avoid electro migration.

6. Pin Assignment (top view)

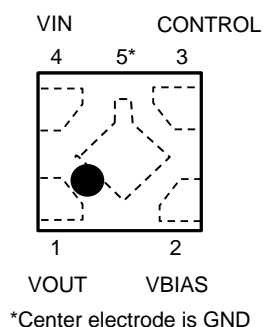

7. List of Products Number, Output voltage and Marking

Product No.	V _{OUT} (V) (Typ.)	Marking	Product No.	V _{OUT} (V) (Typ.)	Marking
TCR5BM08A	0.8	0N8	TCR5BM19A*	1.9	1N9
TCR5BM085A	0.85	0NJ	TCR5BM20A*	2.0	2N0
TCR5BM09A	0.9	0N9	TCR5BM21A	2.1	2N1
TCR5BM095A	0.95	0NK	TCR5BM22A	2.2	2N2
TCR5BM10	1.0	1L0	TCR5BM23A	2.3	2N3
TCR5BM10A	1.0	1N0	TCR5BM24A	2.4	2N4
TCR5BM105	1.05	1LA	TCR5BM25A	2.5	2N5
TCR5BM105A	1.05	1NA	TCR5BM26A	2.6	2N6
TCR5BM11	1.1	1L1	TCR5BM27A	2.7	2N7
TCR5BM11A	1.1	1N1	TCR5BM28A	2.8	2N8
TCR5BM115A	1.15	1NB	TCR5BM285A*	2.85	2NJ
TCR5BM12	1.2	1L2	TCR5BM29A*	2.9	2N9
TCR5BM12A	1.2	1N2	TCR5BM295A	2.95	2NK
TCR5BM125A	1.25	1NC	TCR5BM30A	3.0	3N0
TCR5BM13A	1.3	1N3	TCR5BM31A	3.1	3N1
TCR5BM14A*	1.4	1N4	TCR5BM32A	3.2	3N2
TCR5BM15A*	1.5	1N5	TCR5BM33A	3.3	3N3
TCR5BM16A*	1.6	1N6	TCR5BM34A*	3.4	3N4
TCR5BM17A*	1.7	1N7	TCR5BM35A*	3.5	3N5
TCR5BM18A	1.8	1N8	TCR5BM36A	3.6	3N6

* Please contact your local Toshiba representative if you are interested in products with * sign
TCR5BMxxA products have under voltage lockout function.

Top Marking (top view)

Example: TCR5BM10 (1.0 V output)

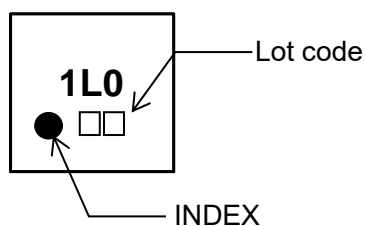

8. Block Diagram

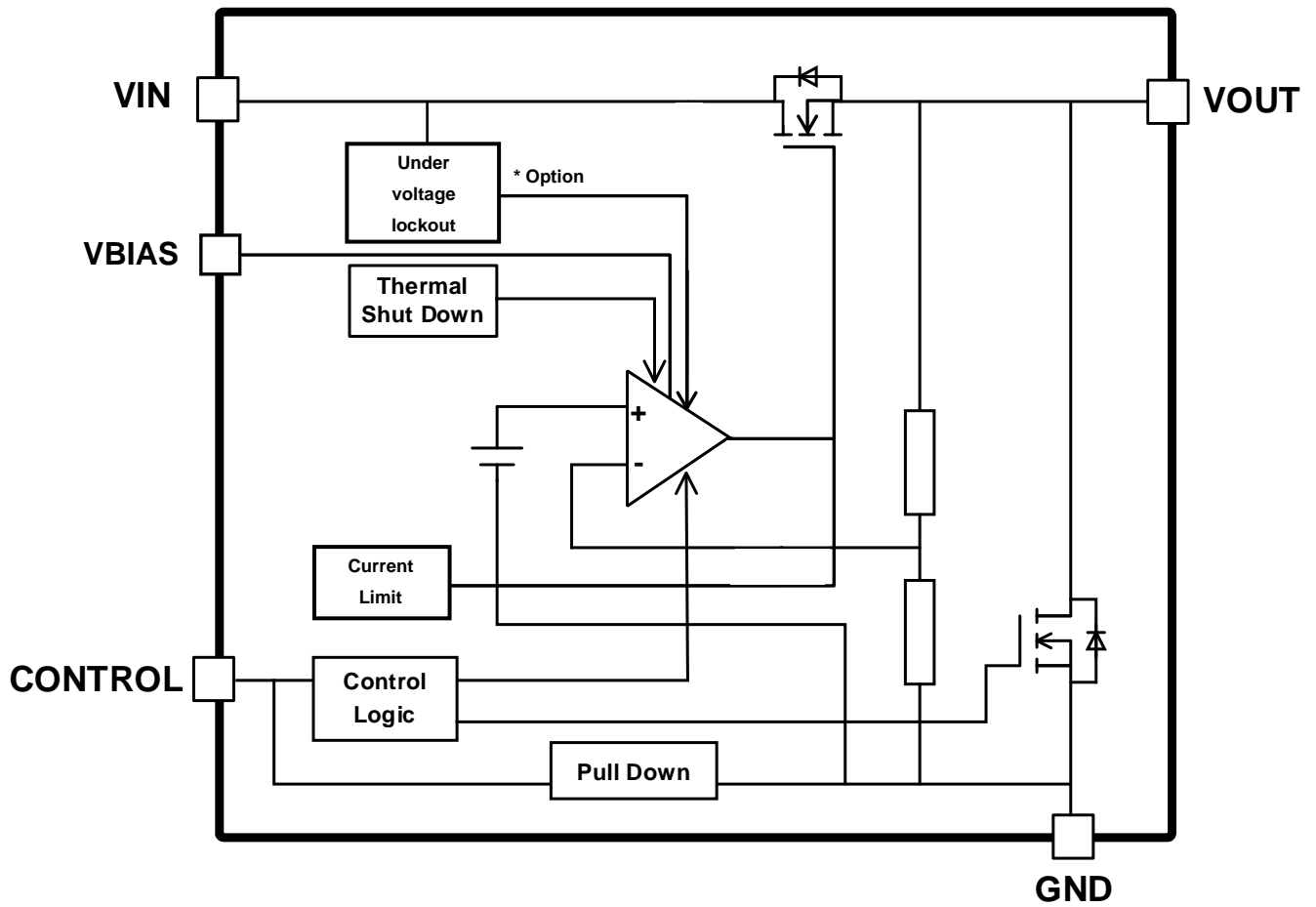

* Under voltage lockout is applied TCR5BMxxA products.

9. Electrical Characteristics

(Unless otherwise specified, $V_{BIAS} = 3.3\text{ V}$ or $V_{OUT} + 1.7\text{ V}$ whichever is greater, $V_{IN} = V_{OUT} + 0.5\text{ V}$, $C_{IN} = 1.0\text{ }\mu\text{F}$, $C_{OUT} = 2.2\text{ }\mu\text{F}$, $C_{BIAS} = 0.1\text{ }\mu\text{F}$)

Characteristics	Symbol	Test Condition	$T_j = 25\text{ }^\circ\text{C}$			$T_j = -40\text{ to }85\text{ }^\circ\text{C}$ (Note 8)		Unit	
			Min	Typ.	Max	Min	Max		
Output voltage accuracy	V_{OUT}	$I_{OUT} = 50\text{ mA}$ (Note 3)	$V_{OUT} < 1.8\text{ V}$	-18	—	+18	—	—	mV
			$1.8\text{ V} \leq V_{OUT}$	-1.0	—	+1.0	—	—	%
Line regulation	Reg. line	$V_{OUT} + 0.5\text{ V} \leq V_{IN} \leq 5.5\text{ V}$, $I_{OUT} = 1\text{ mA}$	—	0.1	—	—	—	—	mV
Load regulation	Reg. load	$1\text{ mA} \leq I_{OUT} \leq 500\text{ mA}$ (Note 5)	—	7	—	—	—	—	mV
Quiescent current (Note 4)	$I_{BIAS}(\text{ON})$	$I_{OUT} = 0\text{ mA}$, V_{BIAS} current	—	19	—	—	—	36	μA
	$I_{IN}(\text{ON})$	$I_{OUT} = 0\text{ mA}$, V_{IN} current	—	3	—	—	—	6	
Stand-by current	$I_{BIAS}(\text{OFF})$	$V_{CT} = 0\text{ V}$, V_{BIAS} current	—	0.1	—	—	—	1.0	μA
	$I_{IN}(\text{OFF})$	$V_{CT} = 0\text{ V}$, V_{IN} current	—	—	0.5	—	—	—	μA
Control pull down current	I_{CT}	—	—	0.1	—	—	—	—	μA
Dropout voltage	V_{DO}	$I_{OUT} = 500\text{ mA}$, $V_{BIAS} = 3.3\text{ V}$ $V_{OUT} = 1.1\text{ V}$ (Note 6)	—	100	—	—	—	140	mV
Under voltage lockout (Note 9)	V_{UVLO}	V_{IN} voltage	—	0.6	—	—	—	0.75	V
Temperature coefficient	T_{CVO}	$-40^\circ\text{C} \leq T_{opr} \leq 85^\circ\text{C}$	—	70	—	—	—	—	ppm/ $^\circ\text{C}$
Output noise voltage	V_{NO}	$V_{BIAS} = 3.3\text{ V}$, $V_{IN} = V_{OUT} + 0.5\text{ V}$ $I_{OUT} = 10\text{ mA}$, $10\text{ Hz} \leq f \leq 100\text{ kHz}$ (Note 7)	—	40	—	—	—	—	μV_{rms}
Ripple rejection ratio	R.R.	$V_{BIAS} = 3.3\text{ V}$, $V_{IN} = V_{OUT} + 1\text{ V}$ $I_{OUT} = 10\text{ mA}$, $f = 1\text{ kHz}$ V_{IN} Ripple = 200 mV_{p-p} (Note 7)	—	98	—	—	—	—	dB
Load transient response	ΔV_{OUT}	$I_{OUT} = 1\text{ mA to }500\text{ mA}$ (Note 5)	—	-60	—	—	—	—	mV
		$I_{OUT} = 500\text{ mA to }1\text{ mA}$ (Note 5)	—	+60	—	—	—	—	
Control voltage (ON)	$V_{CT}(\text{ON})$	—	0.9	—	V_{BIAS}	1.0	V_{BIAS}	—	V
Control voltage (OFF)	$V_{CT}(\text{OFF})$	—	0	—	0.4	0	0.4	—	V
Current limit	I_{CL}	—	—	900	—	550	—	—	mA
Output discharge on resistance	R_{SD}	—	—	10	—	—	—	—	Ω

Note 3: Stable state with fixed I_{OUT} condition

Note 4: Except Control pull down current

Note 5: The 1.0 V output product

Note 6: $V_{DO} = V_{IN1} - (V_{OUT1} \times 0.97)$

V_{OUT1} is the output voltage when $V_{IN} = V_{OUT} + 0.5\text{ V}$.

V_{IN1} is the input voltage at which the output voltage becomes 97% of V_{OUT1} after gradually decreasing the input voltage.

Note 7: The 0.8 V output product

Note 8: This parameter is warranted by design.

Note 9: Under voltage lockout is applied TCR5BMxxA products.

10. Dropout voltage

($C_{IN} = 1.0 \mu\text{F}$, $C_{OUT} = 2.2 \mu\text{F}$, $C_{BIAS} = 0.1 \mu\text{F}$, $T_j = 25 \text{ }^\circ\text{C}$)

Output voltages	VBIAS input voltage	I _{OUT} = 500 mA			Unit
		Min	Typ.	Max (Note 10)	
0.8 V, 0.85 V	3.3 V	—	90	125	mV
0.9 V, 0.95 V	3.3 V	—	95	130	mV
1.0 V	3.3 V	—	95	135	mV
1.05 V, 1.1 V	3.3 V	—	100	140	mV
1.15 V	3.3 V	—	100	145	mV
1.2 V	3.3 V	—	105	150	mV
1.25 V	3.3 V	—	110	155	mV
1.3 V	3.3 V	—	110	160	mV
1.4 V	3.3 V	—	120	170	mV
1.5 V	3.3 V	—	125	190	mV
1.6 V	3.3 V	—	140	215	mV
1.7 V ≤ V _{OUT} ≤ 1.9 V	V _{OUT} + 1.7 V	—	135	210	mV
2.0 V, 2.1 V	V _{OUT} + 1.7 V	—	135	205	mV
2.2 V ≤ V _{OUT} ≤ 2.7 V	V _{OUT} + 1.7 V	—	135	200	mV
2.8 V ≤ V _{OUT} ≤ 3.6 V	V _{OUT} + 1.7 V	—	130	195	mV

Note 10: $T_j = -40$ to $85 \text{ }^\circ\text{C}$ This parameter is warranted by design

11. Application Note

11.1. Example of Application Circuit

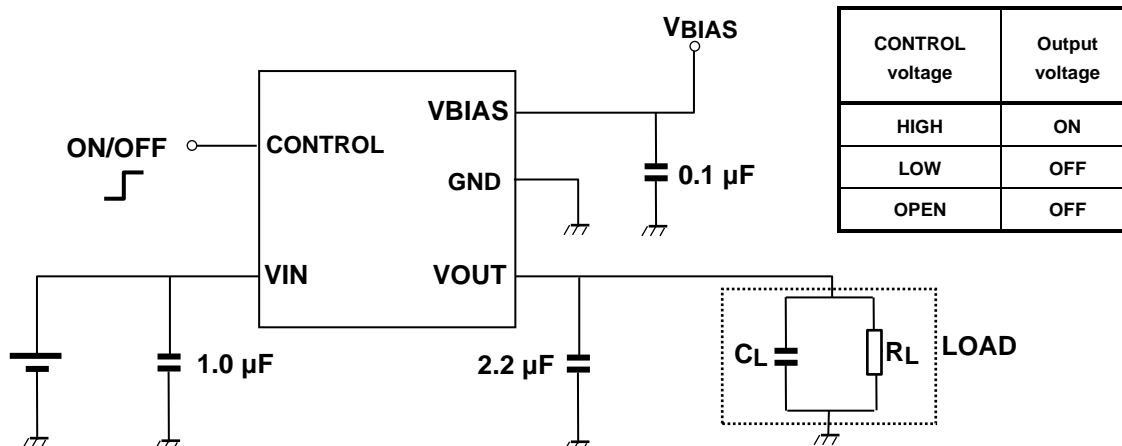

The figure above shows the Example of configuration for using a Low dropout regulator. Insert a capacitor at V_{IN} , V_{OUT} and V_{BIAS} pins for stable input/output operation. (Ceramic capacitors can be used).

11.2. Power Dissipation

Board-mounted power dissipation ratings for TCR5BM series are available in the Absolute Maximum Ratings table. Power dissipation is measured on the board condition shown in below.

[The Board Condition]

- Board material: Glass epoxy (FR4)
- Board dimension: 40 mm x 40 mm (4layer), $t = 1.8$ mm
- Metal pattern ratio: approximately 70 % each layer

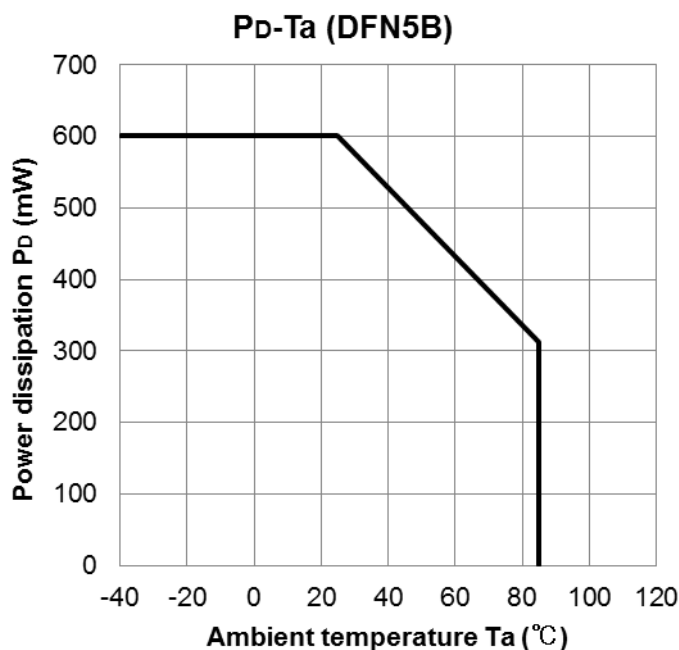

11.3. Attention in Use

- **Capacitors(Output, Input, and Bias Capacitor)**
Ceramic capacitors can be used for these devices. However, because of the type of the capacitors, there might be unexpected thermal features. Please consider application condition for selecting capacitors. For stable operation, please use over 1.0 μF input capacitor, 0.1 μF bias capacitor and 2.2 μF output ceramic capacitor.
- **Recommending for Control Pin Operation**
This device is optimized to operate the best performance when turn on and off with control pin. Especially the rush current and bias current can be suppressed by using control pin after applying V_{IN} and V_{BIAS} .
TCR5BMxxA products have V_{IN} under voltage lockout function, bias current is suppressed at low V_{IN} even when V_{BIAS} and V_{CT} are applied.
- **Mounting**
The long distance between IC and output capacitor might affect phase compensation by impedance in wire and inductor. For stable power supply, output capacitor need to mount near IC as much as possible. Also V_{IN} and GND pattern need to be large and make the wire impedance small as possible.
- **Permissible Loss**
Please have enough design patterns for expected maximum permissible loss. And under consideration of ambient temperature, input voltage, and output current etc, we recommend proper dissipation ratings for maximum permissible loss; in general maximum dissipation rating is 70 to 80 percent.
- **Overcurrent Protection and Thermal shutdown**
Overcurrent protection and Thermal shutdown are designed in these products, but these are not designed to constantly ensure the suppression of the device within operation limits. Depending on the condition during actual usage, it could affect the electrical characteristic specification and reliability. Also note that if output pins and GND pins are not completely shorted out, these products might break down.
When using these products, please read through and understand the concept of dissipation for absolute maximum ratings from the above mention or our 'Semiconductor Reliability Handbook'. Then use these products under absolute maximum ratings in any condition. Furthermore, Toshiba recommends inserting failsafe system into the design.

12. Representative Typical Characteristics

12.1. Dropout Voltage vs. Output Current ($T_a = 25\text{ }^\circ\text{C}$)

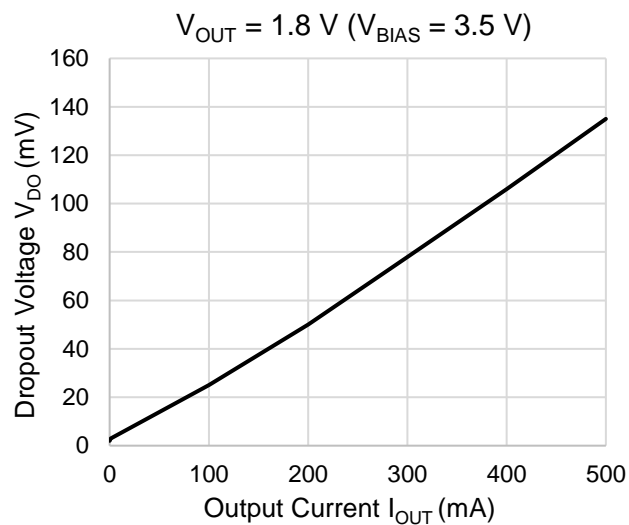
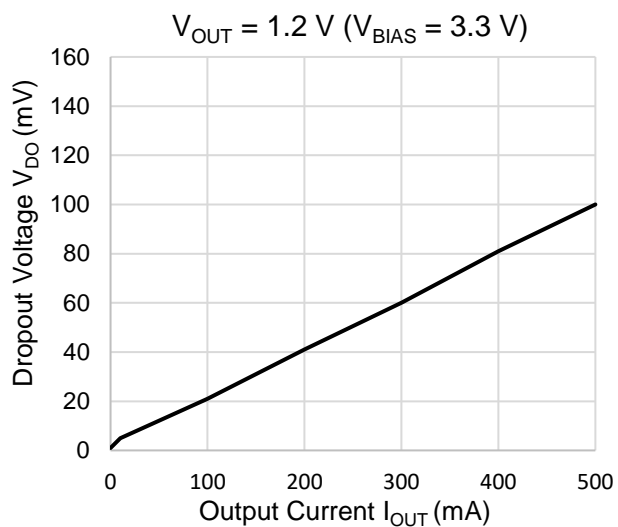

12.2. Output Current Limit ($T_a = 25\text{ }^\circ\text{C}$)

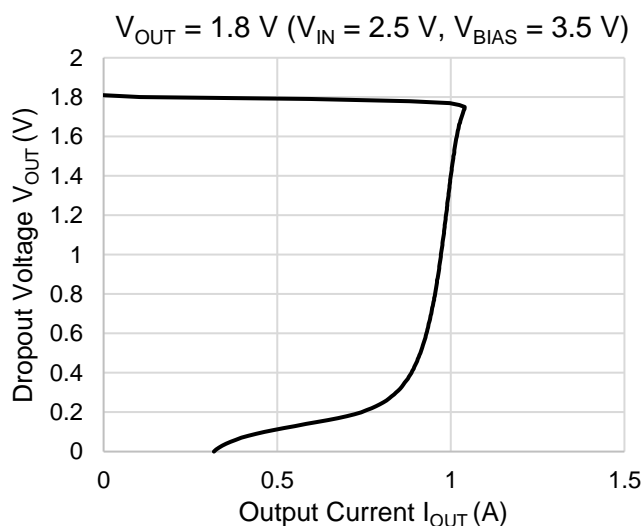
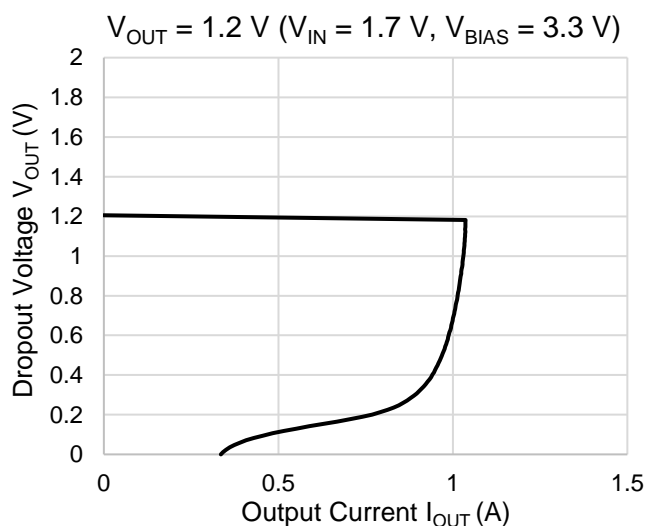

12.3. Ripple rejection Ratio vs. Frequency

(C_{IN} = none, C_{OUT} = 2.2 μ F, V_{IN} = 2.2 V, V_{BIAS} = 3.3 V, $V_{IN\ Ripple}$ = 200 mV_{p-p}, T_a = 25 °C)

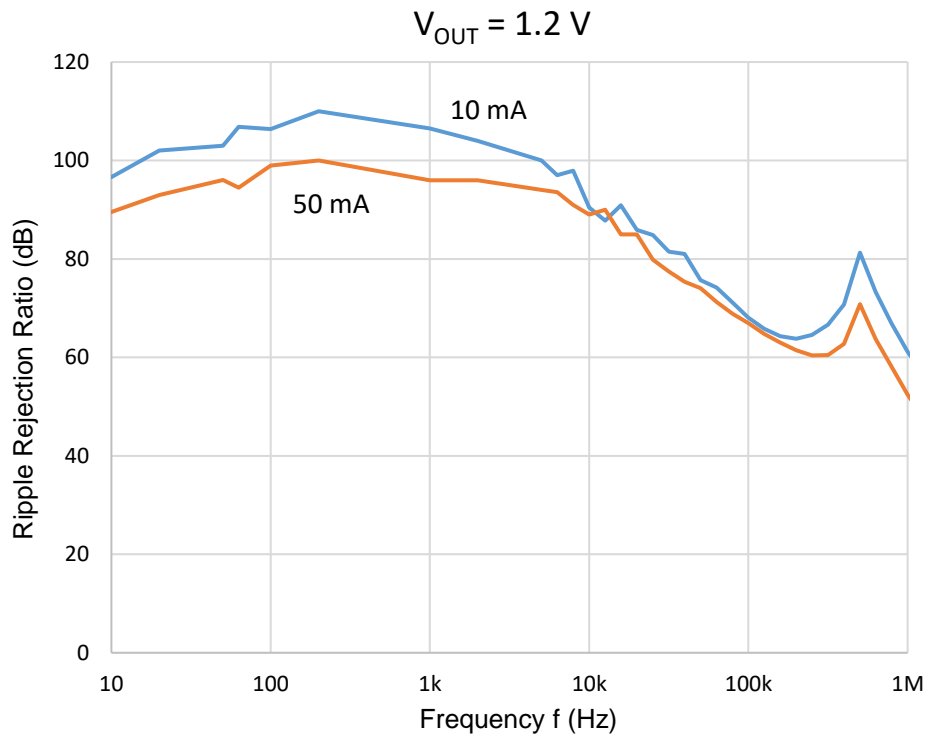

12.4. t_{ON} / t_{OFF} Response

($C_{IN} = 1.0 \mu\text{F}$, $C_{OUT} = 2.2 \mu\text{F}$, $V_{CONTROL} = 0 \text{ V} \leftrightarrow 1 \text{ V}$, $T_a = 25 \text{ }^\circ\text{C}$)

- $I_{OUT} = 0 \text{ mA}$

$V_{OUT} = 1.2 \text{ V}$ ($V_{IN} = 1.7 \text{ V}$, $V_{BIAS} = 3.3 \text{ V}$)

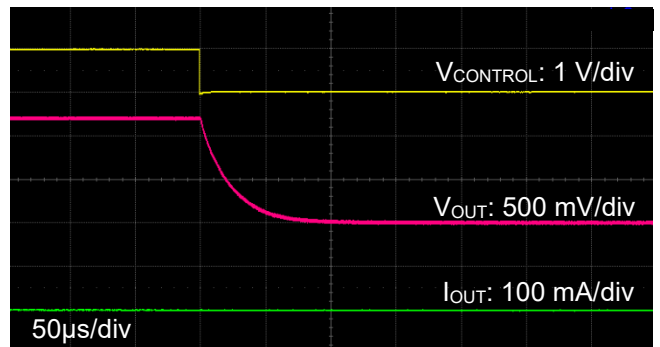
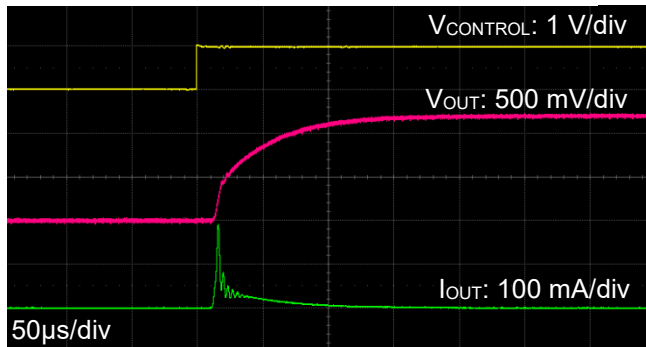

$V_{OUT} = 1.8 \text{ V}$ ($V_{IN} = 2.5 \text{ V}$, $V_{BIAS} = 3.5 \text{ V}$)

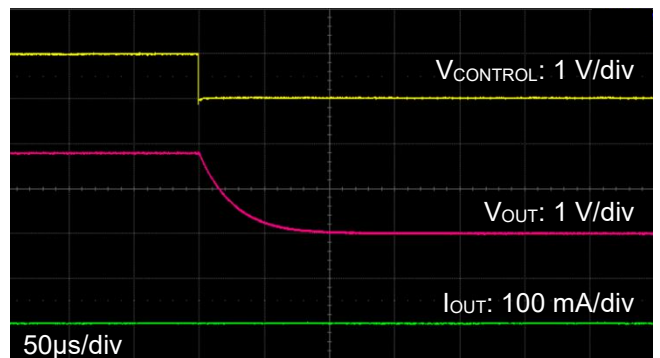
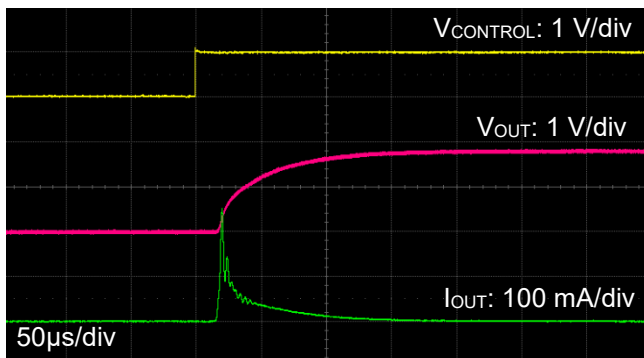

- $I_{OUT} = 500 \text{ mA}$

$V_{OUT} = 1.2 \text{ V}$ ($V_{IN} = 1.7 \text{ V}$, $V_{BIAS} = 3.3 \text{ V}$)

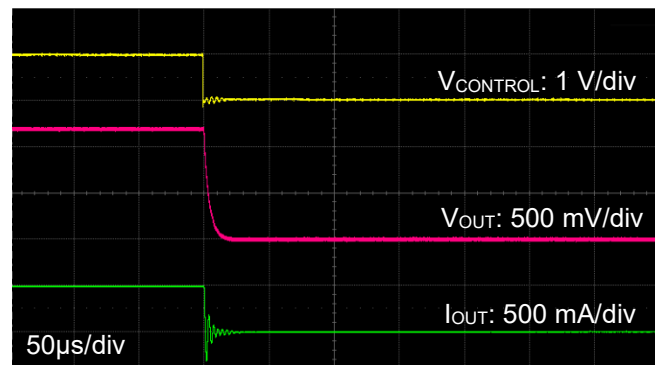
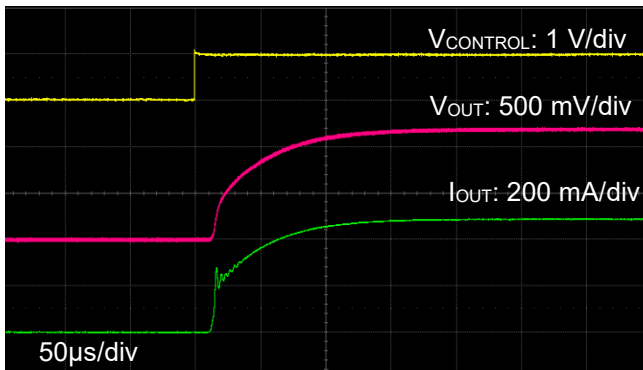

$V_{OUT} = 1.8 \text{ V}$ ($V_{IN} = 2.5 \text{ V}$, $V_{BIAS} = 3.5 \text{ V}$)

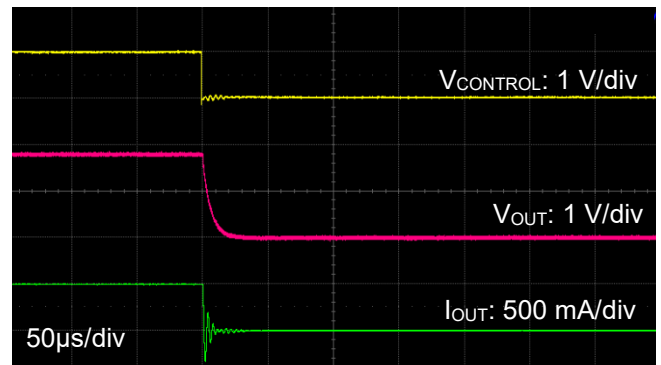
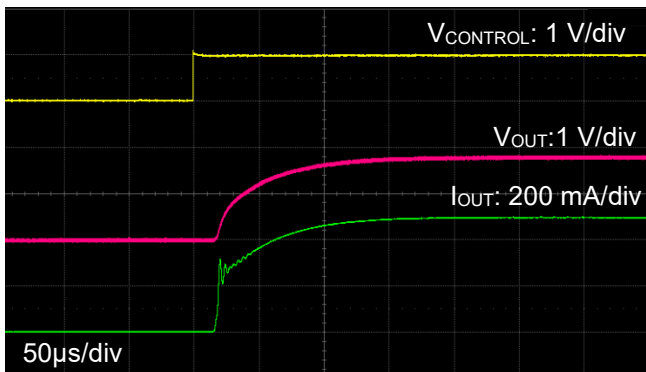

12.5. Load Transient Response

($C_{IN} = 1 \mu F$, $C_{OUT} = 2.2 \mu F$, $I_{OUT} = 1 \text{ mA} \leftrightarrow 500 \text{ mA}$, $t_r = 1 \mu s$, $t_f = 1 \mu s$, $T_a = 25 \text{ }^\circ\text{C}$)

$V_{OUT} = 1.2 \text{ V}$ ($V_{IN} = 1.7 \text{ V}$, $V_{BIAS} = 3.3 \text{ V}$)

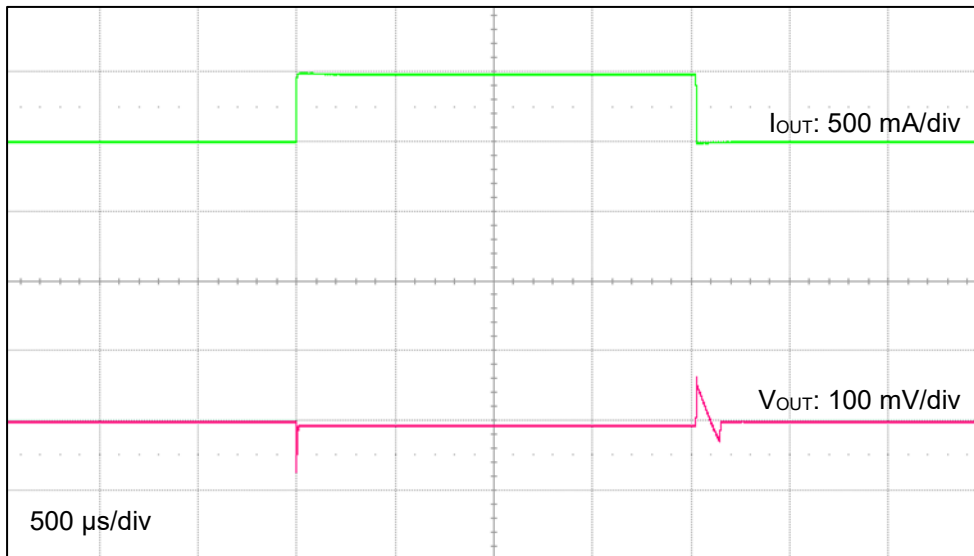

$V_{OUT} = 1.8 \text{ V}$ ($V_{IN} = 2.5 \text{ V}$, $V_{BIAS} = 3.5 \text{ V}$)

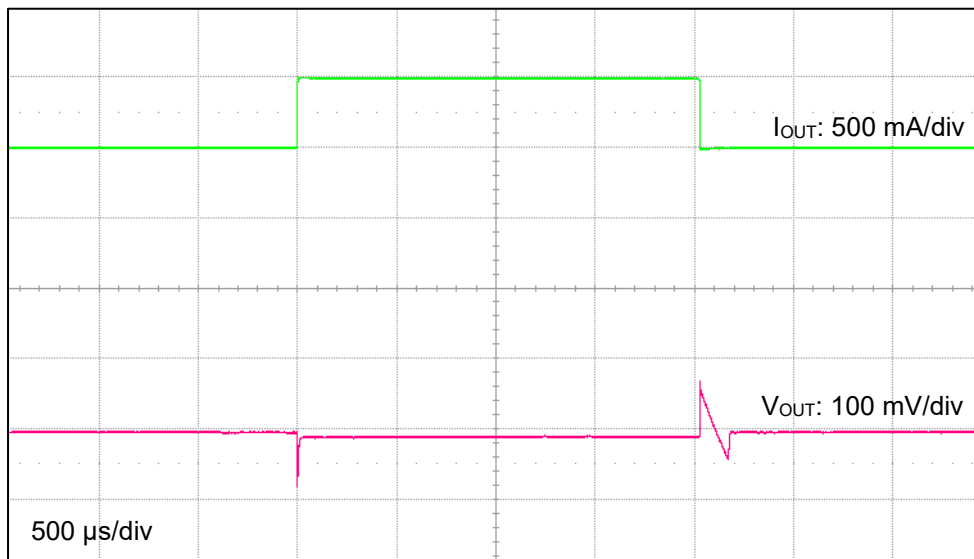

The above characteristics curves are presented for reference only and not guaranteed by production test, unless otherwise noted.

13. Package Dimensions

DFN5B

Unit: mm

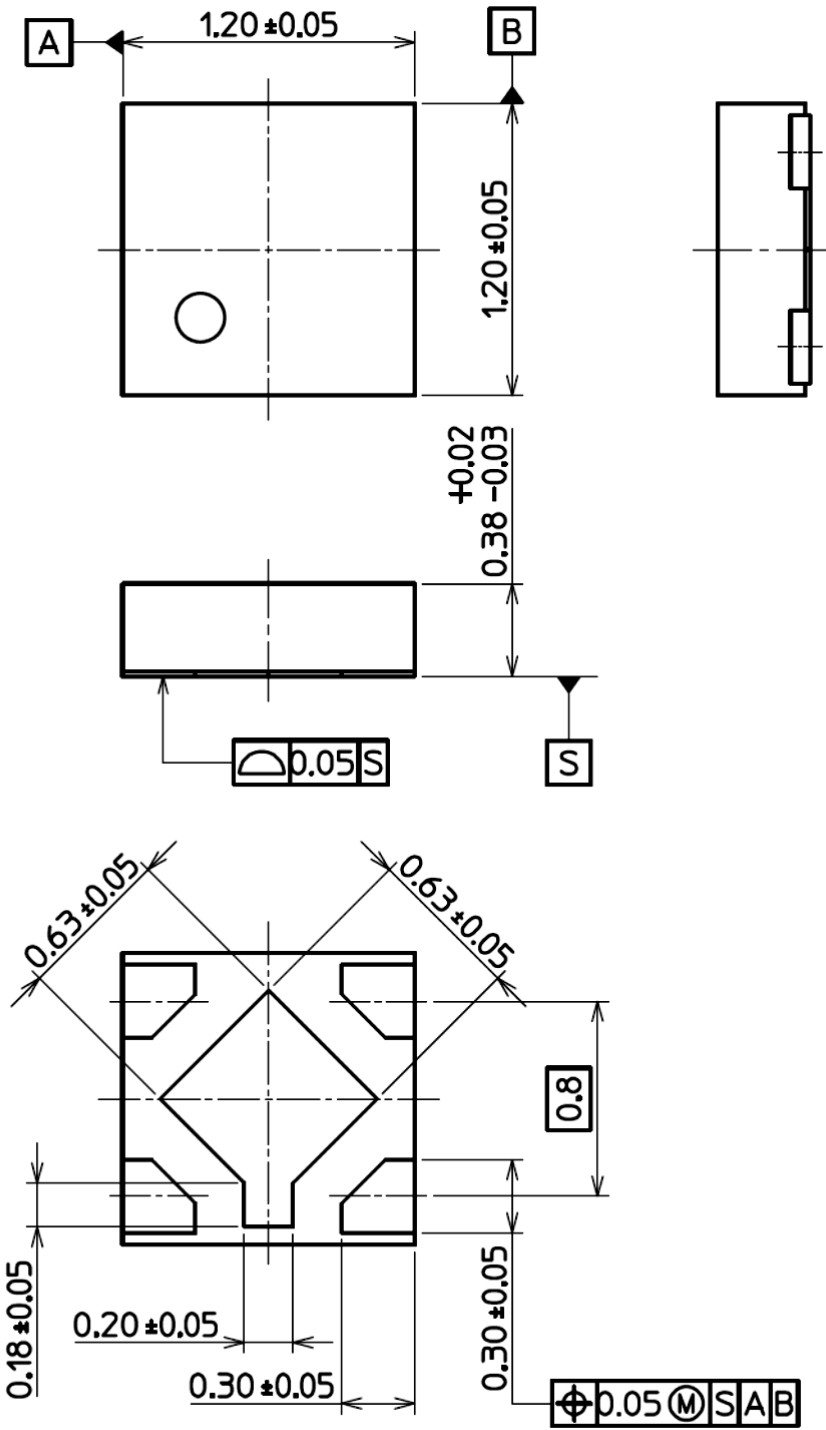

BOTTOM VIEW

Weight : 1.4 mg (Typ.)

14. Land pattern dimensions for reference only

DFN5B

Unit: mm

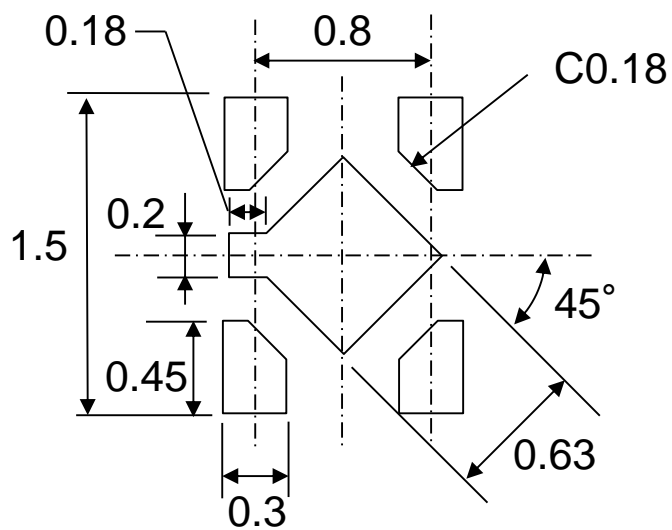

RESTRICTIONS ON PRODUCT USE

Toshiba Corporation and its subsidiaries and affiliates are collectively referred to as "TOSHIBA". Hardware, software and systems described in this document are collectively referred to as "Product".

- TOSHIBA reserves the right to make changes to the information in this document and related Product without notice.
- This document and any information herein may not be reproduced without prior written permission from TOSHIBA. Even with TOSHIBA's written permission, reproduction is permissible only if reproduction is without alteration/omission.
- Though TOSHIBA works continually to improve Product's quality and reliability, Product can malfunction or fail. Customers are responsible for complying with safety standards and for providing adequate designs and safeguards for their hardware, software and systems which minimize risk and avoid situations in which a malfunction or failure of Product could cause loss of human life, bodily injury or damage to property, including data loss or corruption. Before customers use the Product, create designs including the Product, or incorporate the Product into their own applications, customers must also refer to and comply with (a) the latest versions of all relevant TOSHIBA information, including without limitation, this document, the specifications, the data sheets and application notes for Product and the precautions and conditions set forth in the "TOSHIBA Semiconductor Reliability Handbook" and (b) the instructions for the application with which the Product will be used with or for. Customers are solely responsible for all aspects of their own product design or applications, including but not limited to (a) determining the appropriateness of the use of this Product in such design or applications; (b) evaluating and determining the applicability of any information contained in this document, or in charts, diagrams, programs, algorithms, sample application circuits, or any other referenced documents; and (c) validating all operating parameters for such designs and applications. **TOSHIBA ASSUMES NO LIABILITY FOR CUSTOMERS' PRODUCT DESIGN OR APPLICATIONS.**
- **PRODUCT IS NEITHER INTENDED NOR WARRANTED FOR USE IN EQUIPMENTS OR SYSTEMS THAT REQUIRE EXTRAORDINARILY HIGH LEVELS OF QUALITY AND/OR RELIABILITY, AND/OR A MALFUNCTION OR FAILURE OF WHICH MAY CAUSE LOSS OF HUMAN LIFE, BODILY INJURY, SERIOUS PROPERTY DAMAGE AND/OR SERIOUS PUBLIC IMPACT ("UNINTENDED USE").** Except for specific applications as expressly stated in this document, Unintended Use includes, without limitation, equipment used in nuclear facilities, equipment used in the aerospace industry, lifesaving and/or life supporting medical equipment, equipment used for automobiles, trains, ships and other transportation, traffic signaling equipment, equipment used to control combustions or explosions, safety devices, elevators and escalators, and devices related to power plant. **IF YOU USE PRODUCT FOR UNINTENDED USE, TOSHIBA ASSUMES NO LIABILITY FOR PRODUCT.** For details, please contact your TOSHIBA sales representative or contact us via our website.
- Do not disassemble, analyze, reverse-engineer, alter, modify, translate or copy Product, whether in whole or in part.
- Product shall not be used for or incorporated into any products or systems whose manufacture, use, or sale is prohibited under any applicable laws or regulations.
- The information contained herein is presented only as guidance for Product use. No responsibility is assumed by TOSHIBA for any infringement of patents or any other intellectual property rights of third parties that may result from the use of Product. No license to any intellectual property right is granted by this document, whether express or implied, by estoppel or otherwise.
- **ABSENT A WRITTEN SIGNED AGREEMENT, EXCEPT AS PROVIDED IN THE RELEVANT TERMS AND CONDITIONS OF SALE FOR PRODUCT, AND TO THE MAXIMUM EXTENT ALLOWABLE BY LAW, TOSHIBA (1) ASSUMES NO LIABILITY WHATSOEVER, INCLUDING WITHOUT LIMITATION, INDIRECT, CONSEQUENTIAL, SPECIAL, OR INCIDENTAL DAMAGES OR LOSS, INCLUDING WITHOUT LIMITATION, LOSS OF PROFITS, LOSS OF OPPORTUNITIES, BUSINESS INTERRUPTION AND LOSS OF DATA, AND (2) DISCLAIMS ANY AND ALL EXPRESS OR IMPLIED WARRANTIES AND CONDITIONS RELATED TO SALE, USE OF PRODUCT, OR INFORMATION, INCLUDING WARRANTIES OR CONDITIONS OF MERCHANTABILITY, FITNESS FOR A PARTICULAR PURPOSE, ACCURACY OF INFORMATION, OR NONINFRINGEMENT.**
- Do not use or otherwise make available Product or related software or technology for any military purposes, including without limitation, for the design, development, use, stockpiling or manufacturing of nuclear, chemical, or biological weapons or missile technology products (mass destruction weapons). Product and related software and technology may be controlled under the applicable export laws and regulations including, without limitation, the Japanese Foreign Exchange and Foreign Trade Law and the U.S. Export Administration Regulations. Export and re-export of Product or related software or technology are strictly prohibited except in compliance with all applicable export laws and regulations.
- Please contact your TOSHIBA sales representative for details as to environmental matters such as the RoHS compatibility of Product. Please use Product in compliance with all applicable laws and regulations that regulate the inclusion or use of controlled substances, including without limitation, the EU RoHS Directive. **TOSHIBA ASSUMES NO LIABILITY FOR DAMAGES OR LOSSES OCCURRING AS A RESULT OF NONCOMPLIANCE WITH APPLICABLE LAWS AND REGULATIONS.**