

Automotive Brake Control

Solution Proposal by Toshiba

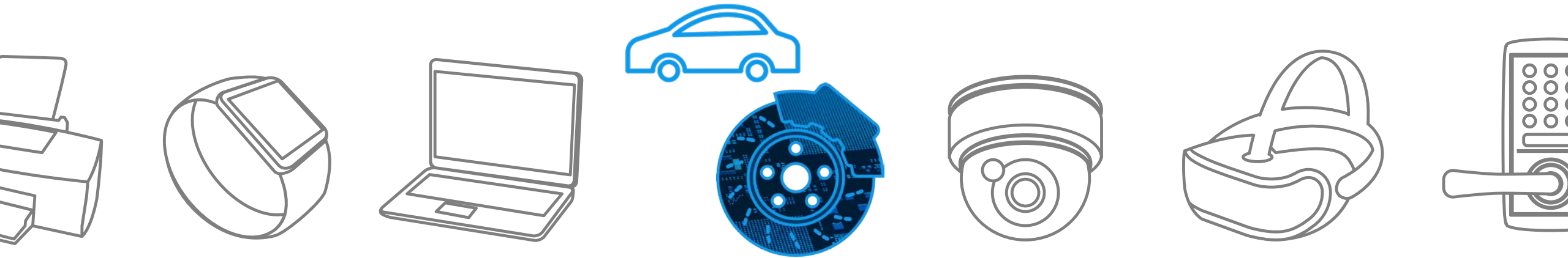

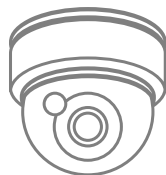
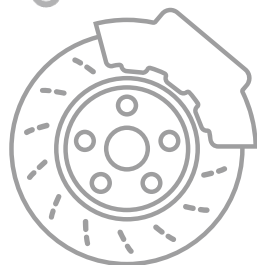

Toshiba Electronic Devices & Storage Corporation provides comprehensive device solutions to customers developing new products by applying its thorough understanding of the systems acquired through the analysis of basic product designs.

Block Diagram

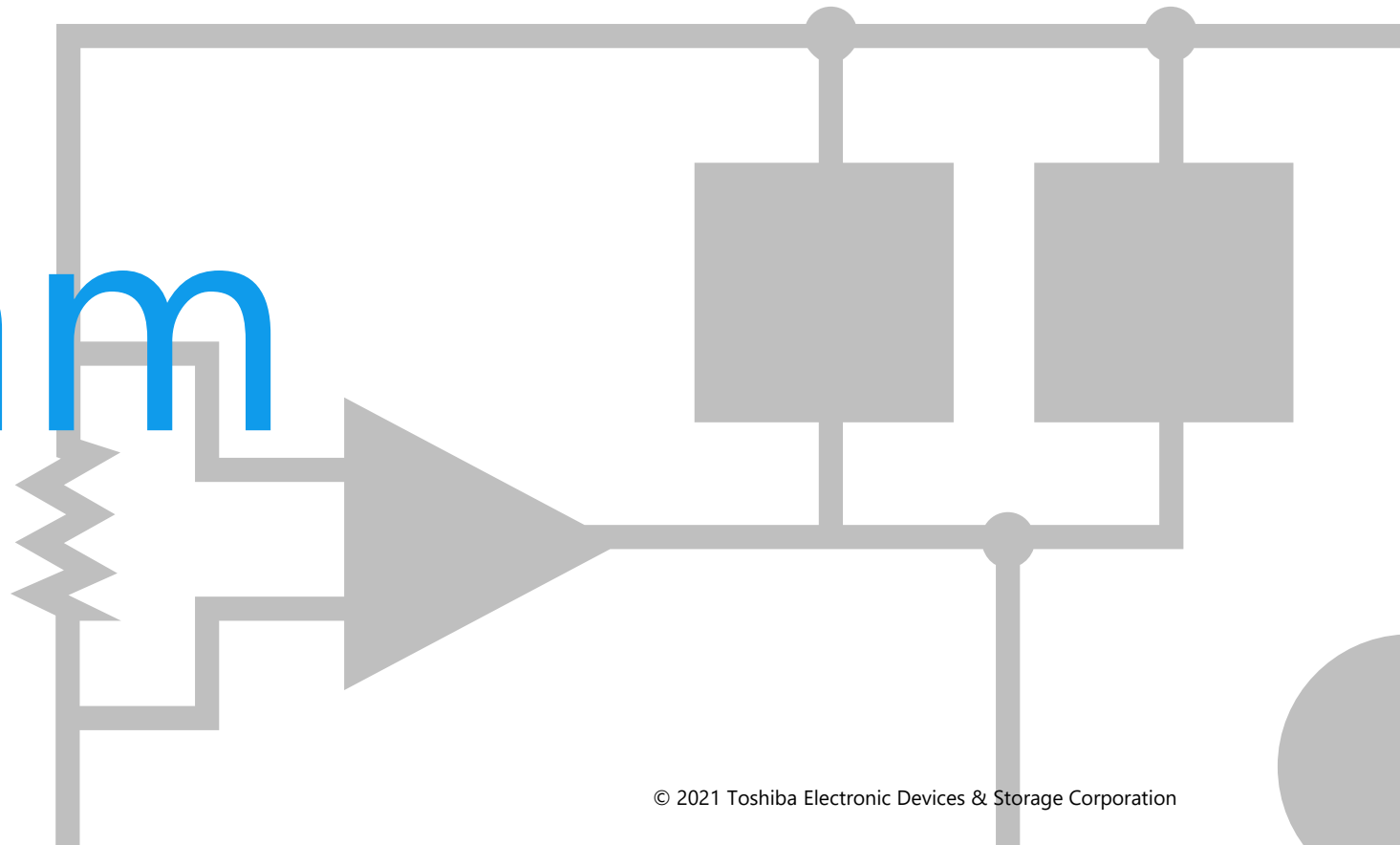

Brake Control Overall block diagram

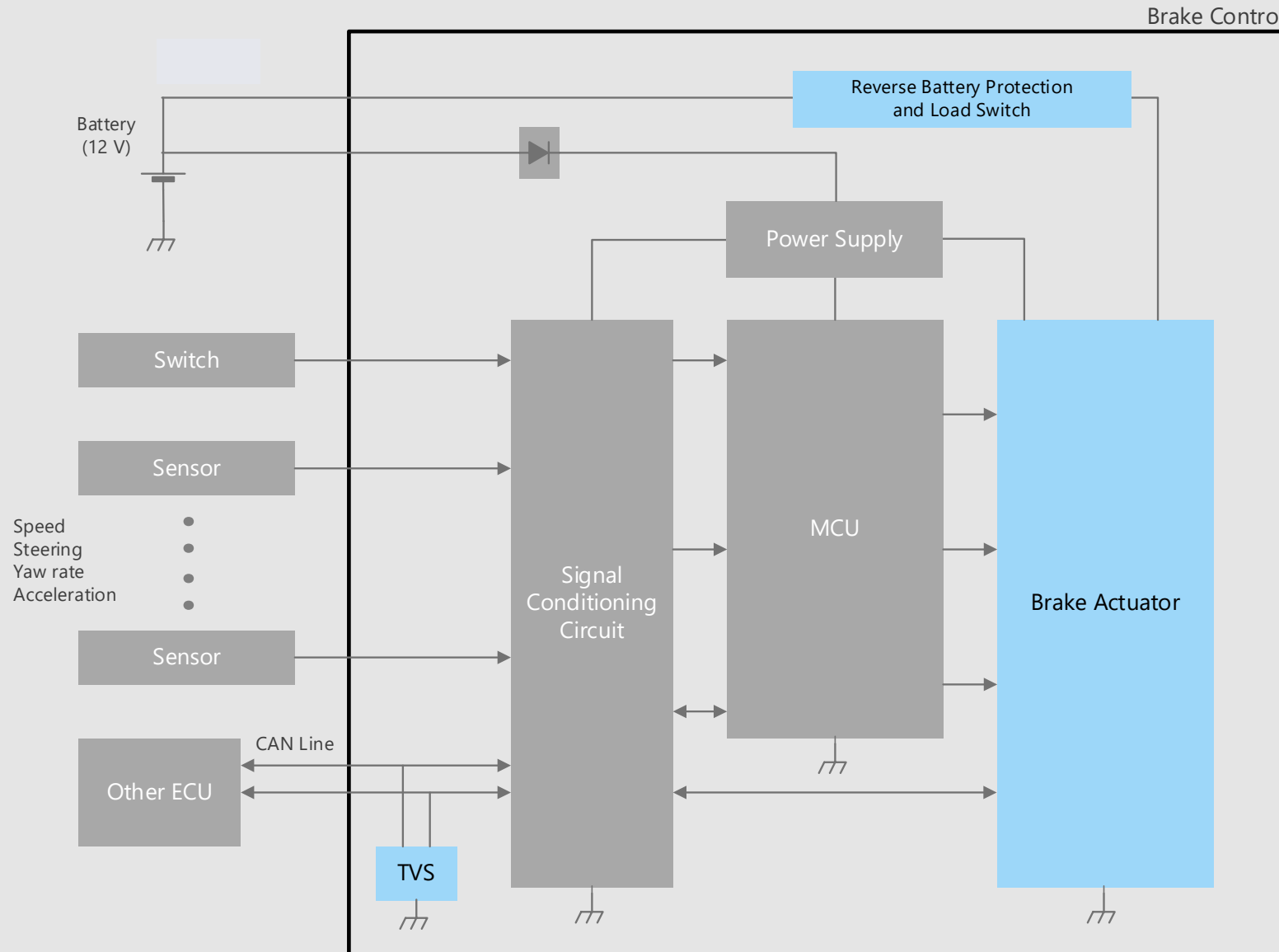

Brake Control Detail of brake actuator

Brake actuator for ABS/ESC

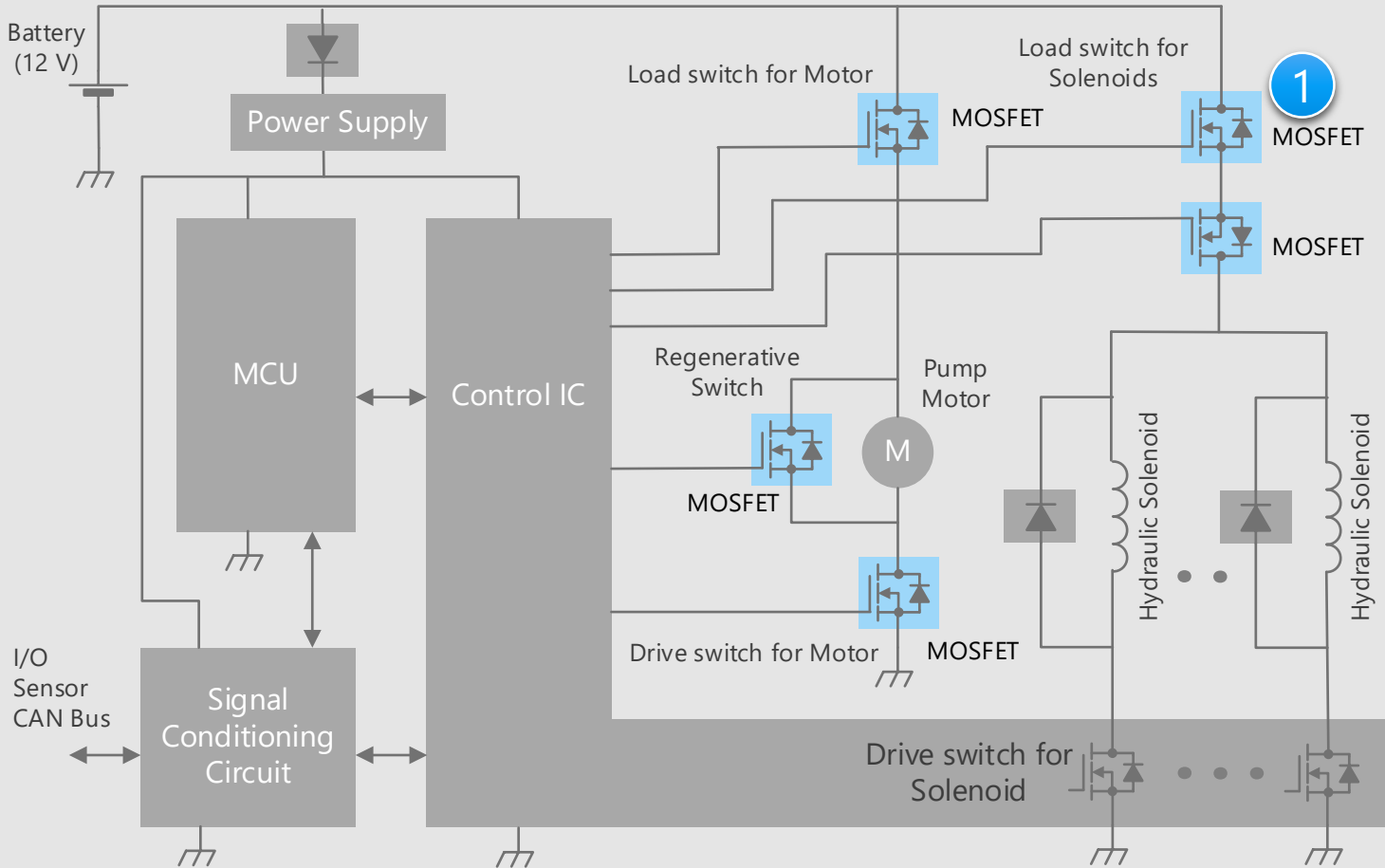

* Click on the numbers in the circuit diagram to jump to the detailed descriptions page

Criteria for device selection

- It is necessary to select the product with the suitable voltage and current ratings for each application.
- A small surface mount package is suitable for realizing miniaturization of the ECU.

Proposals from Toshiba

- **Low on-resistance contributes low power consumption of the system**
U-MOS Series 40 V N-ch MOSFET

Power supply ON/OFF control and reverse connection protection circuit (P-ch type)

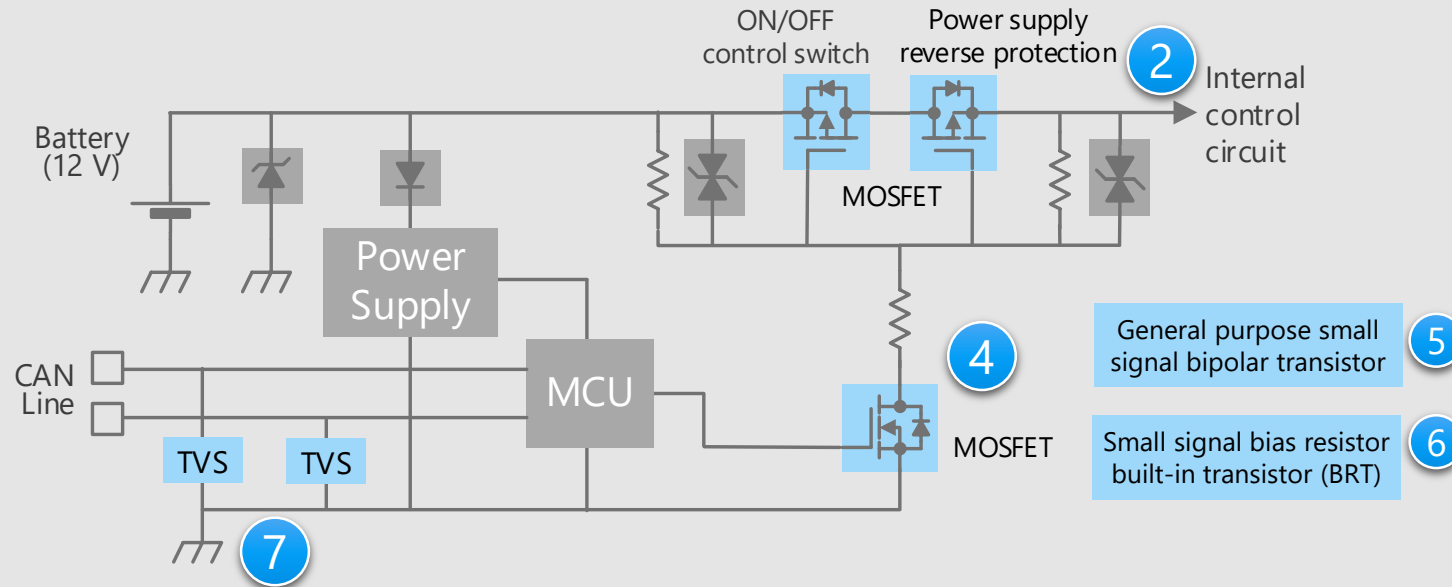

Criteria for device selection

- It is necessary to select the product with the suitable voltage and current ratings for each application.
- It is necessary to select a gate driver according to the characteristics of the switching device to be driven.
- A small surface mount package is suitable for realizing miniaturization of the ECU.

Proposals from Toshiba

- **Low on-resistance contributes low power consumption of the system**

U-MOS Series -40 V / -60 V P-ch MOSFET

- **Extensive product lineup**

General purpose small signal MOSFET

General purpose small signal bipolar transistor

Small signal bias resistor built-in transistor (BRT)

- **Suitable for ESD protection**

TVS diode (for CAN communication)

* Click on the numbers in the circuit diagram to jump to the detailed descriptions page

Power supply ON/OFF control and reverse connection protection circuit (N-ch type)

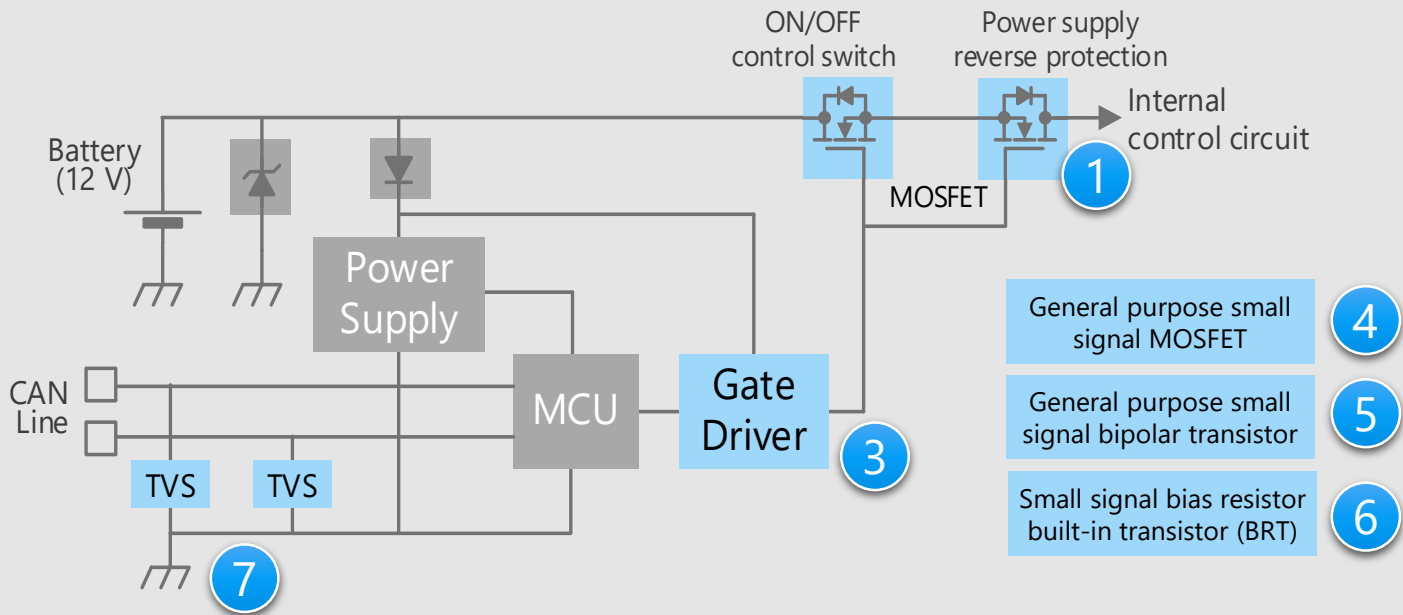

Criteria for device selection

- It is necessary to select the product with the suitable voltage and current ratings for each application.
- It is necessary to select a gate driver according to the characteristics of the switching device to be driven.
- A small surface mount package is suitable for realizing miniaturization of the ECU.

Proposals from Toshiba

- **Low on-resistance contributes low power consumption of the system**

U-MOS Series 40V N-ch MOSFET

- **Gate driver with protection and diagnosis functions**

Gate driver (for switch)

- **Extensive product lineup**

General purpose small signal MOSFET

General purpose small signal bipolar transistor

Small signal bias resistor built-in transistor (BRT)

- **Suitable for ESD protection**

TVS diode (for CAN communication)

* Click on the numbers in the circuit diagram to jump to the detailed descriptions page

Recommended Devices

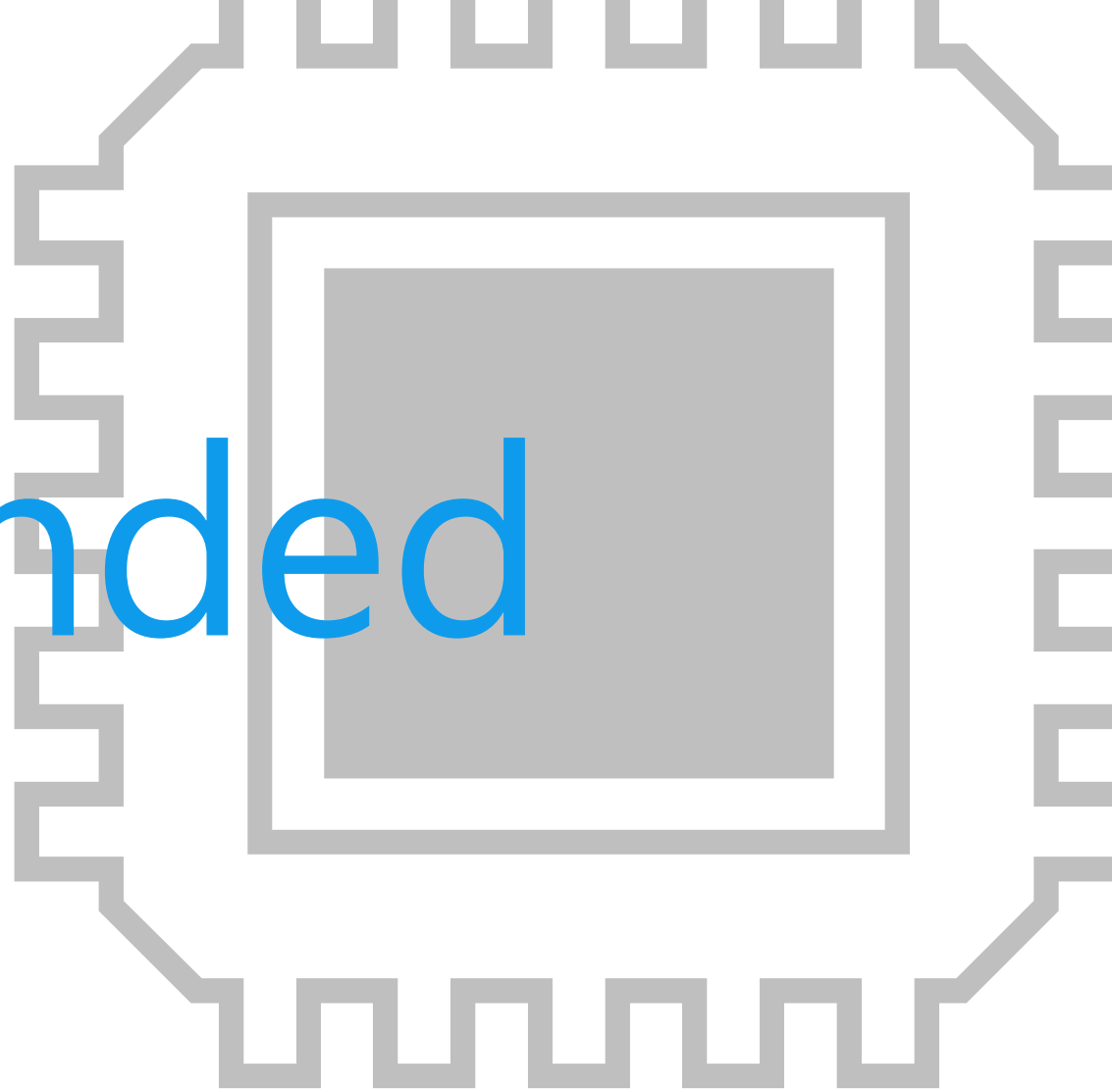

Device solutions to address customer needs

As described above, in the design of brake control, “**Improvement of safety**”, “**Reduction of power consumption**” and “**Miniaturization**” are important factors. Toshiba’s proposals are based on these three solution perspectives.

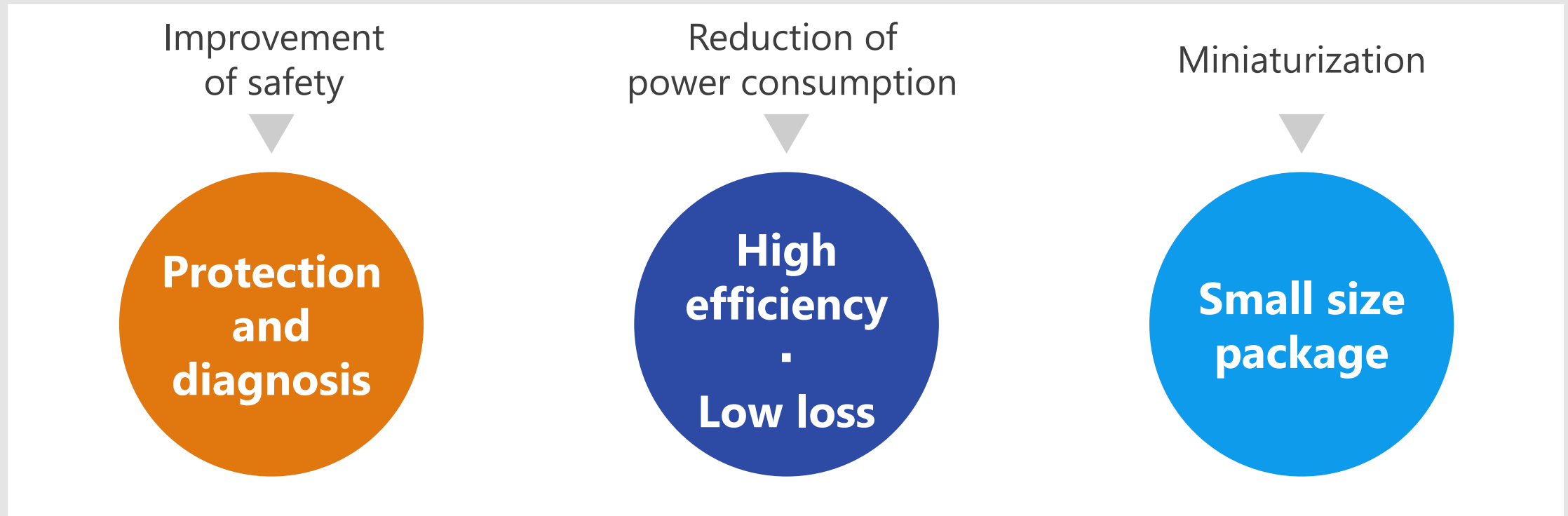

Device solutions to address customer needs

Protection
and
diagnosis

High
efficiency
·
Low loss

Small size
package

①	U-MOS Series 40 V N-ch MOSFET	●	●
②	U-MOS Series -40 V / -60 V P-ch MOSFET	●	●
③	Gate driver (for switch)	●	●
④	General purpose small signal MOSFET	●	●
⑤	General purpose small signal bipolar transistor		●
⑥	Small signal bias resistor built-in transistor (BRT)		●
⑦	TVS diode (for CAN communication)	●	●

Value provided

The advanced U-MOSIX-H processes enables low on-resistance and low noise, thereby reducing power consumption.

1 Low loss (reduced on-resistance)

Using low on-resistance technology to contribute to reduced power consumption systems.
On-resistance of 61 % reduction per unit area. (compared to U-MOSIV)

2 Compact and low loss package

By adopting a Cu connector structure and a double-sided heat dissipation structure, low loss and high heat dissipation are realized.
Wettable Frank (WF) package contributes good mountability.

3 Low noise (low EMI)

Improved chip process reduces surge voltage and ringing time.

Low Loss: RonA Trend

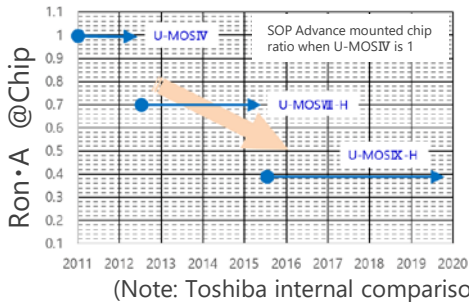

Low-noise: Switching waveform

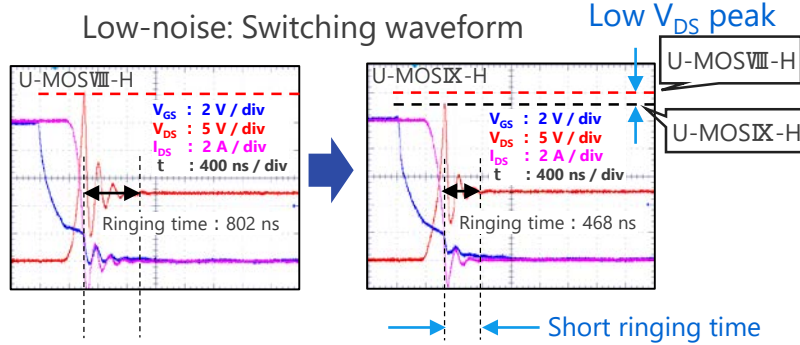

TO-220SM(W) Cu connector design







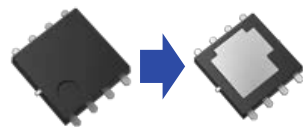

Package resistance is reduced by 64 %, compared to D2PAK+.

DSOP Advance(WF)L double-sided cooling package



Thermal resistance is reduced by 76 % @t = 3 s, mounted on board compared to SOP Advance(WF).

Line up			
Part number	Drain current	On-resistance (Max) @V _{GS} = 10 V	Package
XPN3R804NC	40 A	3.8 mΩ	TSON Advance(WF) 
TK1R4S04PB	120 A	1.35 mΩ	DPAK+ 
TPHR7904PB	150 A	0.79 mΩ	SOP Advance(WF) 
TPWR7904PB	150 A	0.79 mΩ	DSOP Advance(WF)L 
TKR74F04PB	250 A	0.74 mΩ	TO-220SM(W) 
TK1R5R04PB	160 A	1.5 mΩ	D2PAK+ 

Value provided

Low on-resistance contributes to reduce system power consumption.

1 Low loss (reduced on-resistance) and logic level drive



Using low on-resistance technology contributes to reduce system power consumption.
Lineups of logic level drive type are supported.

2 Small surface mount package developed

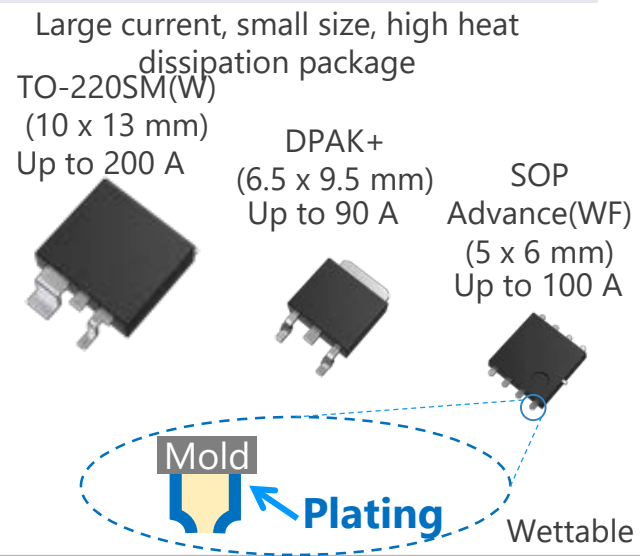
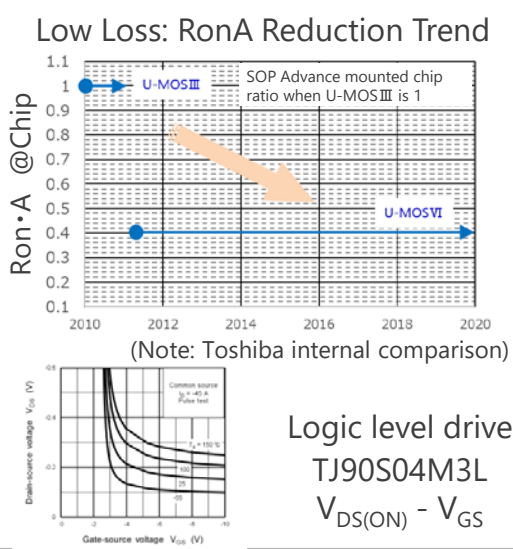
By adopting a Cu connector structure and a double-sided heat dissipation structure, low loss and high heat dissipation are realized.
Wettable Frank (WF) package contributes good mountability.



Line up

Part number	Drain-source Voltage	Drain current	On-resistance (Max) @V _{GS} = -10 V	Package
TJ90S04M3L	-40 V	-90 A	4.3 mΩ	DPAK+ 
TJ60S06M3L	-60 V	-60 A	11.2 mΩ	
XPH3R114MC	-40 V	-100 A	3.1 mΩ	SOP Advance(WF) 
TJ200F04M3L	-40 V	-200 A	1.8 mΩ	TO-220SM(W) 

[Return to Block Diagram TOP](#)

3 Gate driver (for switch)

TPD7104AF / TPD7106F / TPD7107F

Protection and diagnosis

High efficiency
Low loss

Small size package

Value provided

A charge pump circuit for the N-channel MOSFET gate drive is built in, allowing for easy semiconductor relay configuration.

1 Built-in charge pump circuit

Built-in charge pump circuit enables N-channel MOSFET as high side switch.
Easy to configure a semiconductor relay.

2 Can be controlled by logic level voltage

It is possible that Direct control by output signal of MCUs or CMOS logic ICs.

3 Small package

The small surface mount packages such as PS-8, SSOP16 and WSON10A contribute to the miniaturization of system.

Semiconductor relay (switch) application (TPD7104AF)

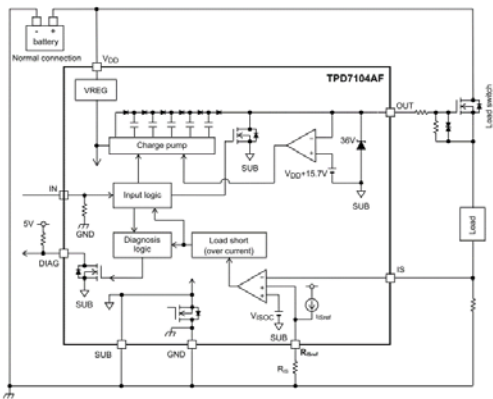

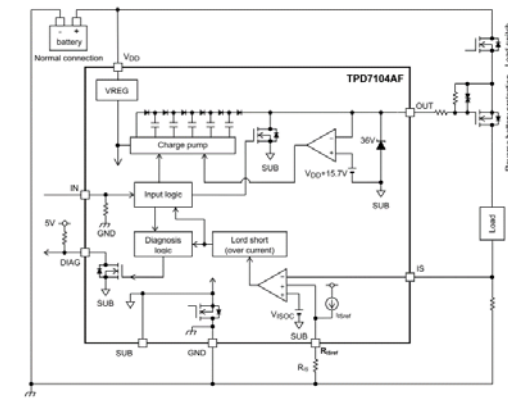

Power supply reverse connection protection MOSFET control (TPD7104AF)



Back to back configuration

Line up

Part number	TPD7104AF	TPD7106F	TPD7107F
Package	PS-8 (2.8 x 2.9 mm) 	SSOP16 (5.5 x 6.4 mm) 	WSON10A (3 x 3 mm) 
Features	<ul style="list-style-type: none"> Operating power supply voltage range: 5 to 18 V Built-in power supply reverse connection protection function (Supported for power supply reverse connection protection MOSFET applications)	<ul style="list-style-type: none"> Operating power supply voltage range: 4.5 to 27 V Built-in power supply reverse connection protection function (Supported for power supply reverse connection protection MOSFET applications)	<ul style="list-style-type: none"> Operating power supply voltage range: 5.75 to 26 V Current sense output Protective functions; overcurrent, overtemperature, GND disconnect etc. reverse battery connection Diagnosis output; overcurrent, load open, overtemperature etc.

[Return to Block Diagram TOP](#)

4 General purpose small signal MOSFET

SSM3K7002KF / SSM3J168F / SSM3J66MFV

Protection and diagnosis

High efficiency
Low loss

Small size package

Value provided

Wide lineup of small packages contribute to reduce the size and power consumption of system.

1 Small package

A lineup of various small packages such as SOT-723 (VESM 1.2 x 1.2 mm package) is available, contributing to reduce mounting area.

2 Low voltage drive

SSM3J66MFV can be driven at low gate-source voltage of 1.2 V.



3 AEC-Q101 qualified

AEC-Q101 qualified and can be used for various automotive applications.

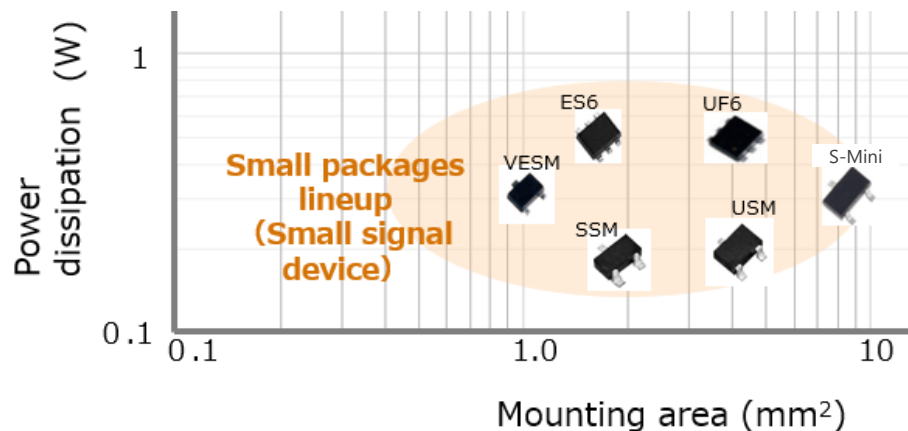
Small signal package lineup



Line up

Part number	SSM3K7002KF	SSM3J168F	SSM3J66MFV
Package	S-Mini (SOT-346) 	S-Mini (SOT-346) 	VESM (SOT-723) 
V_{DSS} [V]	60	-60	-20
I_D [A]	0.4	-0.4	-0.8
$R_{DS(ON)}$ @ $ V_{GS} = 4.5$ V [Ω]	Typ.	1.2	0.31
	Max	1.75	0.39
Drive voltage [V]	4.5	-4.0	-1.2
Polarity	N-ch	P-ch	P-ch

[Return to Block Diagram TOP](#)

Value provided

Extensive product lineup to meet customers' needs.

1 Extensive lineup of packages

Various packages such as 1-in-1, 2-in-1 are provided and suitable products for circuit board design are selectable.

2 Extensive product lineup

Various product lineups, such as general purpose, low noise, low $V_{CE(sat)}$ and high current types are provided. Products can be selected in accordance to the application.

3 AEC-Q101 qualified

AEC-Q101 qualified and can be used for various automotive applications.

Characteristic examples of 2SC2712

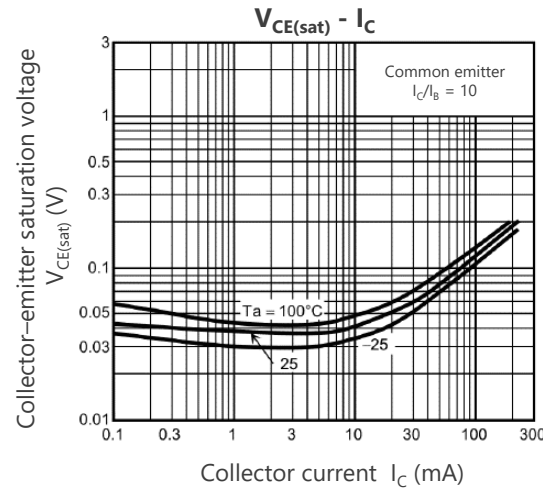
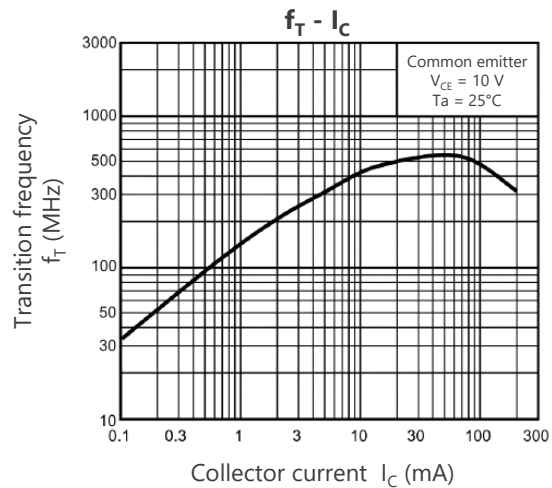

Line up

Package			SOT-23F		USM (SOT-323) UFM (SOT-323F)*		S-Mini (SOT-346)	
Classification	$ V_{CE0} $ [V]	$ I_C $ [mA]	NPN	PNP	NPN	PNP	NPN	PNP
General purpose	50	150			2SC4116	2SA1586	2SC2712	2SA1162
	50	500					2SC3325	2SA1313
Low noise	120	100			2SC4117	2SA1587	2SC2713	2SA1163
High current	50	1700				2SA2195*		
	50	2000		TTA501				
	100	2500	TTC501					

[Return to Block Diagram TOP](#)

Value provided

Extensive product lineup to meet customers' needs.

1 Built-in bias resistor type (BRT : Bias Resistor built-in Transistor)

The BRTs contribute to reduction of the number of components, assembly workload and mounting area of circuit boards.

2 Extensive lineup of package and pin assignment

Various package lineups, such as 1-in-1, 2-in-1 and various pin assignment type are provided and suitable products for circuit board design are selectable.

3 AEC-Q101 qualified

AEC-Q101 qualified and can be used for various automotive applications.

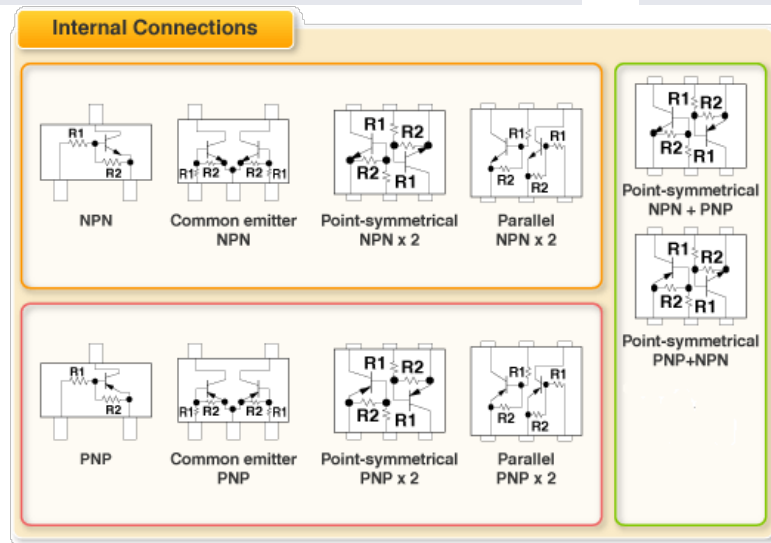

Line up

Part number		NPN (BRT)	PNP (BRT)
Package	ES6 (SOT-563)	RN1907FE	RN2907FE
	US6 (SOT-363)	RN1901	RN2901
V_{CE0} (Max) [V]		50	-50
I_C [mA]		100	-100

[Return to Block Diagram TOP](#)

7 TVS diode (for CAN communication)

DF3D18FU / DF3D29FU / DF3D36FU

Protection and diagnosis

High efficiency
Low loss

Small size package

Value provided

TVS diodes prevent system damage and malfunction caused by electrostatic discharge (ESD).

1 Improve ESD pulse absorbability

Toshiba proprietary Zener process improves the ESD pulse absorption of TVS diodes.
(Both low dynamic resistance R_{DYN} and low capacitance between terminals C_t)

2 Supports CAN, CAN FD and FlexRay

These are products applicable to in-vehicle LAN communication such as CAN, CAN FD and FlexRay.

3 High ESD immunity

$V_{ESD} > \pm 30$ kV @ ISO 10605
 $V_{ESD} > \pm 20$ kV (L4) @ IEC61000-4-2

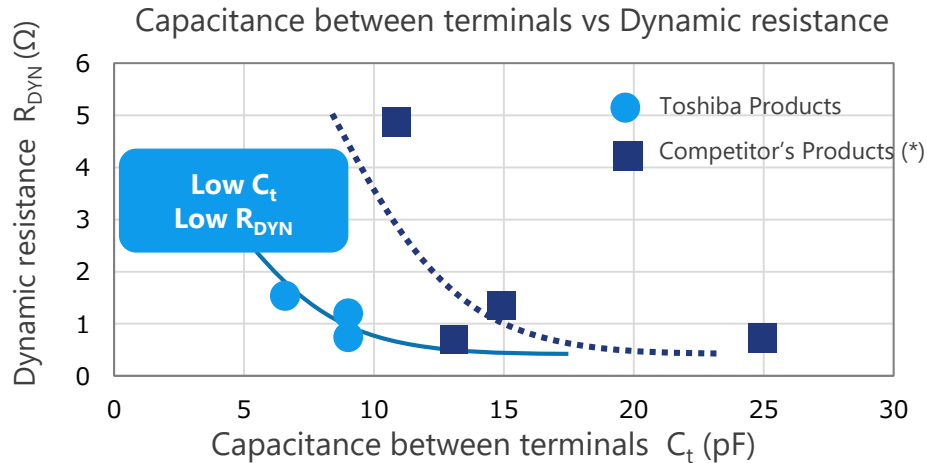

(NOTE) : This product is an ESD protection diode and cannot be used for purposes other than ESD protection.

(Based on Toshiba's measurement data)
(*): Measurements of the commercial product

Line up

Part number	DF3D18FU	DF3D29FU	DF3D36FU
Package	USM (SOT-323) 		
V_{ESD} [kV] @ISO 10605	±30	±30	±20
V_{RWM} (Max) [V]	12	24	28
C_t (Typ. / Max) [pF]	9 / 10		6.5 / 8
R_{DYN} (Typ.) [Ω]	0.8	1.1	1.5

[Return to Block Diagram TOP](#)

If you are interested in these products and have questions or comments about any of them, please do not hesitate to contact us below:

Contact address: <https://toshiba.semicon-storage.com/ap-en/contact.html>

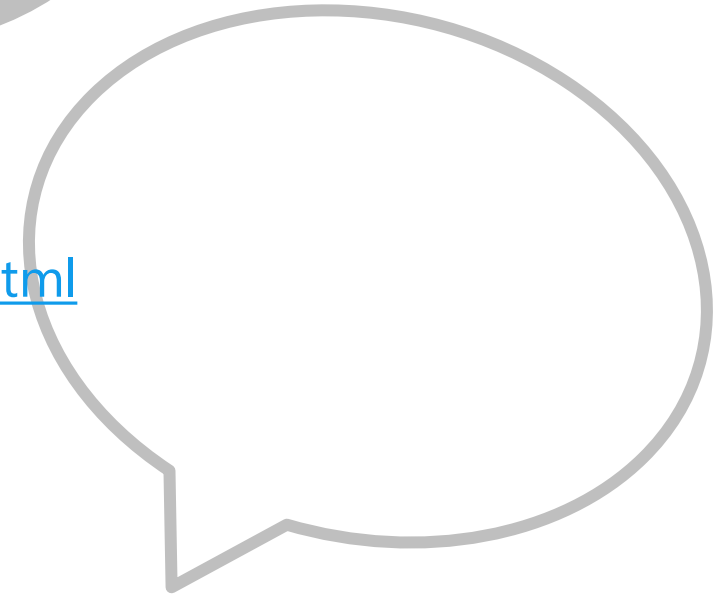

Terms of use

This terms of use is made between Toshiba Electronic Devices and Storage Corporation ("We") and customers who use documents and data that are consulted to design electronics applications on which our semiconductor devices are mounted ("this Reference Design"). Customers shall comply with this terms of use. Please note that it is assumed that customers agree to any and all this terms of use if customers download this Reference Design. We may, at its sole and exclusive discretion, change, alter, modify, add, and/or remove any part of this terms of use at any time without any prior notice. We may terminate this terms of use at any time and for any reason. Upon termination of this terms of use, customers shall destroy this Reference Design. In the event of any breach thereof by customers, customers shall destroy this Reference Design, and furnish us a written confirmation to prove such destruction.

1. Restrictions on usage

- 1.This Reference Design is provided solely as reference data for designing electronics applications. Customers shall not use this Reference Design for any other purpose, including without limitation, verification of reliability.
- 2.This Reference Design is for customer's own use and not for sale, lease or other transfer.
- 3.Customers shall not use this Reference Design for evaluation in high or low temperature, high humidity, or high electromagnetic environments.
- 4.This Reference Design shall not be used for or incorporated into any products or systems whose manufacture, use, or sale is prohibited under any applicable laws or regulations.

2. Limitations

- 1.We reserve the right to make changes to this Reference Design without notice.
- 2.This Reference Design should be treated as a reference only. We are not responsible for any incorrect or incomplete data and information.
- 3.Semiconductor devices can malfunction or fail. When designing electronics applications by referring to this Reference Design, customers are responsible for complying with safety standards and for providing adequate designs and safeguards for their hardware, software and systems which minimize risk and avoid situations in which a malfunction or failure of semiconductor devices could cause loss of human life, bodily injury or damage to property, including data loss or corruption. Customers must also refer to and comply with the latest versions of all relevant our information, including without limitation, specifications, data sheets and application notes for semiconductor devices, as well as the precautions and conditions set forth in the "Semiconductor Reliability Handbook".
- 4.When designing electronics applications by referring to this Reference Design, customers must evaluate the whole system adequately. Customers are solely responsible for all aspects of their own product design or applications. WE ASSUME NO LIABILITY FOR CUSTOMERS' PRODUCT DESIGN OR APPLICATIONS.
- 5.No responsibility is assumed by us for any infringement of patents or any other intellectual property rights of third parties that may result from the use of this Reference Design. No license to any intellectual property right is granted by this terms of use, whether express or implied, by estoppel or otherwise.
- 6.THIS REFERENCE DESIGN IS PROVIDED "AS IS". WE (a) ASSUME NO LIABILITY WHATSOEVER, INCLUDING WITHOUT LIMITATION, INDIRECT, CONSEQUENTIAL, SPECIAL, OR INCIDENTAL DAMAGES OR LOSS, INCLUDING WITHOUT LIMITATION, LOSS OF PROFITS, LOSS OF OPPORTUNITIES, BUSINESS INTERRUPTION AND LOSS OF DATA, AND (b) DISCLAIM ANY AND ALL EXPRESS OR IMPLIED WARRANTIES AND CONDITIONS RELATED TO THIS REFERENCE DESIGN, INCLUDING WARRANTIES OR CONDITIONS OF MERCHANTABILITY, FITNESS FOR A PARTICULAR PURPOSE, ACCURACY OF INFORMATION, OR NONINFRINGEMENT.

3. Export Control

Customers shall not use or otherwise make available this Reference Design for any military purposes, including without limitation, for the design, development, use, stockpiling or manufacturing of nuclear, chemical, or biological weapons or missile technology products (mass destruction weapons). This Reference Design may be controlled under the applicable export laws and regulations including, without limitation, the Japanese Foreign Exchange and Foreign Trade Law and the U.S. Export Administration Regulations. Export and re-export of this Reference Design are strictly prohibited except in compliance with all applicable export laws and regulations.

4. Governing Laws

This terms of use shall be governed and construed by laws of Japan.

RESTRICTIONS ON PRODUCT USE

- Toshiba Electronic Devices & Storage Corporation, and its subsidiaries and affiliates (collectively "TOSHIBA"), reserve the right to make changes to the information in this document, and related hardware, software and systems (collectively "Product") without notice.
- This document and any information herein may not be reproduced without prior written permission from TOSHIBA. Even with TOSHIBA's written permission, reproduction is permissible only if reproduction is without alteration/omission.
- Though TOSHIBA works continually to improve Product's quality and reliability, Product can malfunction or fail. Customers are responsible for complying with safety standards and for providing adequate designs and safeguards for their hardware, software and systems which minimize risk and avoid situations in which a malfunction or failure of Product could cause loss of human life, bodily injury or damage to property, including data loss or corruption. Before customers use the Product, create designs including the Product, or incorporate the Product into their own applications, customers must also refer to and comply with (a) the latest versions of all relevant TOSHIBA information, including without limitation, this document, the specifications, the data sheets and application notes for Product and the precautions and conditions set forth in the "TOSHIBA Semiconductor Reliability Handbook" and (b) the instructions for the application with which the Product will be used with or for. Customers are solely responsible for all aspects of their own product design or applications, including but not limited to (a) determining the appropriateness of the use of this Product in such design or applications; (b) evaluating and determining the applicability of any information contained in this document, or in charts, diagrams, programs, algorithms, sample application circuits, or any other referenced documents; and (c) validating all operating parameters for such designs and applications. **TOSHIBA ASSUMES NO LIABILITY FOR CUSTOMERS' PRODUCT DESIGN OR APPLICATIONS..**
- **PRODUCT IS NEITHER INTENDED NOR WARRANTED FOR USE IN EQUIPMENTS OR SYSTEMS THAT REQUIRE EXTRAORDINARILY HIGH LEVELS OF QUALITY AND/OR RELIABILITY, AND/OR A MALFUNCTION OR FAILURE OF WHICH MAY CAUSE LOSS OF HUMAN LIFE, BODILY INJURY, SERIOUS PROPERTY DAMAGE AND/OR SERIOUS PUBLIC IMPACT ("UNINTENDED USE").** Except for specific applications as expressly stated in this document, Unintended Use includes, without limitation, equipment used in nuclear facilities, equipment used in the aerospace industry, lifesaving and/or life supporting medical equipment, equipment used for automobiles, trains, ships and other transportation, traffic signaling equipment, equipment used to control combustions or explosions, safety devices, elevators and escalators, and devices related to power plant. **IF YOU USE PRODUCT FOR UNINTENDED USE, TOSHIBA ASSUMES NO LIABILITY FOR PRODUCT.** For details, please contact your TOSHIBA sales representative or contact us via our website.
- Do not disassemble, analyze, reverse-engineer, alter, modify, translate or copy Product, whether in whole or in part.
- Product shall not be used for or incorporated into any products or systems whose manufacture, use, or sale is prohibited under any applicable laws or regulations.
- The information contained herein is presented only as guidance for Product use. No responsibility is assumed by TOSHIBA for any infringement of patents or any other intellectual property rights of third parties that may result from the use of Product. No license to any intellectual property right is granted by this document, whether express or implied, by estoppel or otherwise.
- **ABSENT A WRITTEN SIGNED AGREEMENT, EXCEPT AS PROVIDED IN THE RELEVANT TERMS AND CONDITIONS OF SALE FOR PRODUCT, AND TO THE MAXIMUM EXTENT ALLOWABLE BY LAW, TOSHIBA (1) ASSUMES NO LIABILITY WHATSOEVER, INCLUDING WITHOUT LIMITATION, INDIRECT, CONSEQUENTIAL, SPECIAL, OR INCIDENTAL DAMAGES OR LOSS, INCLUDING WITHOUT LIMITATION, LOSS OF PROFITS, LOSS OF OPPORTUNITIES, BUSINESS INTERRUPTION AND LOSS OF DATA, AND (2) DISCLAIMS ANY AND ALL EXPRESS OR IMPLIED WARRANTIES AND CONDITIONS RELATED TO SALE, USE OF PRODUCT, OR INFORMATION, INCLUDING WARRANTIES OR CONDITIONS OF MERCHANTABILITY, FITNESS FOR A PARTICULAR PURPOSE, ACCURACY OF INFORMATION, OR NONINFRINGEMENT.**
- Product may include products using GaAs (Gallium Arsenide). GaAs is harmful to humans if consumed or absorbed, whether in the form of dust or vapor. Handle with care and do not break, cut, crush, grind, dissolve chemically or otherwise expose GaAs in Product.
- Do not use or otherwise make available Product or related software or technology for any military purposes, including without limitation, for the design, development, use, stockpiling or manufacturing of nuclear, chemical, or biological weapons or missile technology products (mass destruction weapons). Product and related software and technology may be controlled under the applicable export laws and regulations including, without limitation, the Japanese Foreign Exchange and Foreign Trade Law and the U.S. Export Administration Regulations. Export and re-export of Product or related software or technology are strictly prohibited except in compliance with all applicable export laws and regulations.
- Please contact your TOSHIBA sales representative for details as to environmental matters such as the RoHS compatibility of Product. Please use Product in compliance with all applicable laws and regulations that regulate the inclusion or use of controlled substances, including without limitation, the EU RoHS Directive. **TOSHIBA ASSUMES NO LIABILITY FOR DAMAGES OR LOSSES OCCURRING AS A RESULT OF NONCOMPLIANCE WITH APPLICABLE LAWS AND REGULATIONS.**

TOSHIBA

* Company names, product names, and service names may be trademarks of their respective companies.