

# Motion Detector

Solution Proposal by Toshiba





Toshiba Electronic Devices & Storage Corporation provides comprehensive device solutions to customers developing new products by applying its thorough understanding of the systems acquired through the analysis of basic product designs.

# Block Diagram

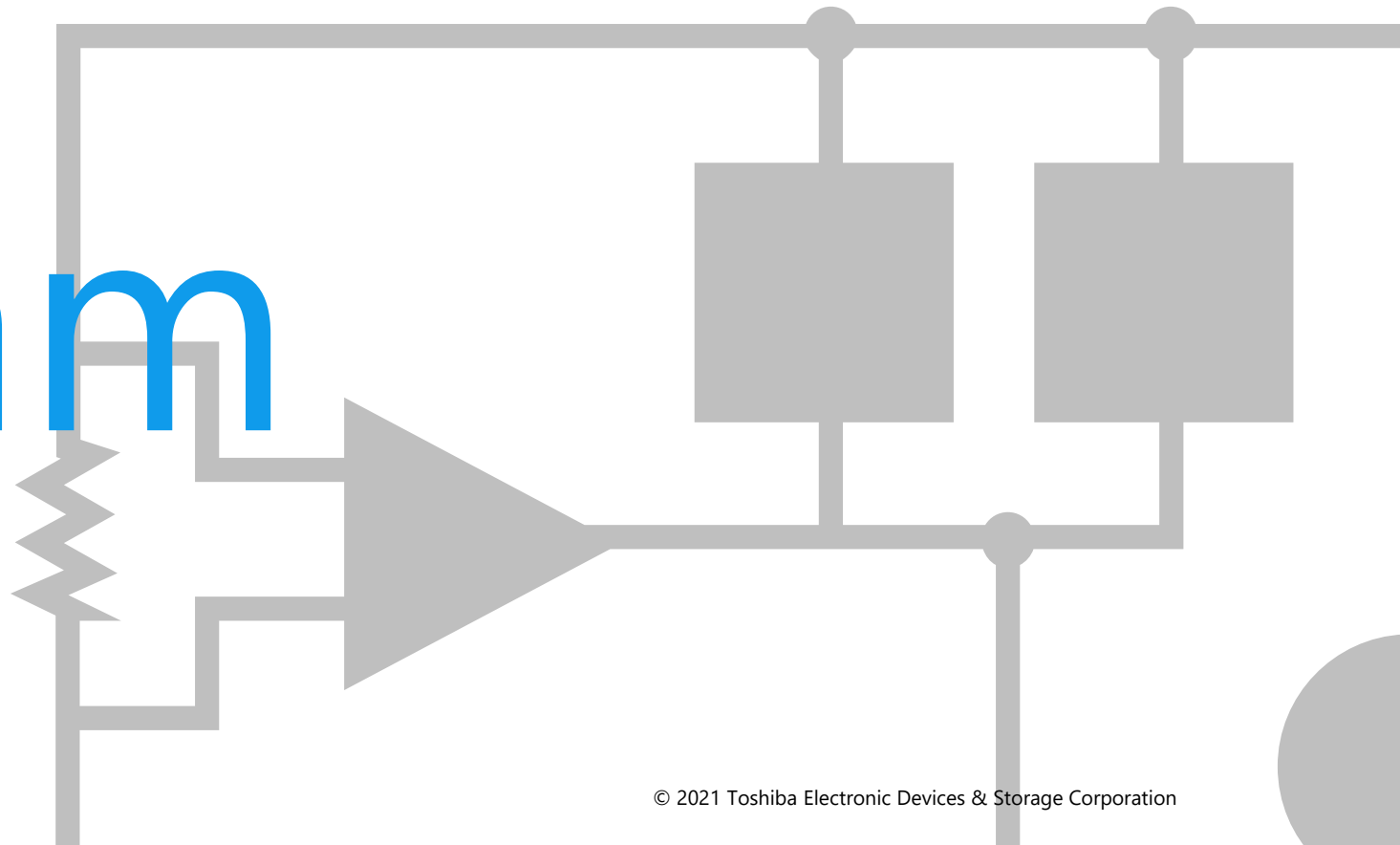

# Motion Detector Overall block diagram

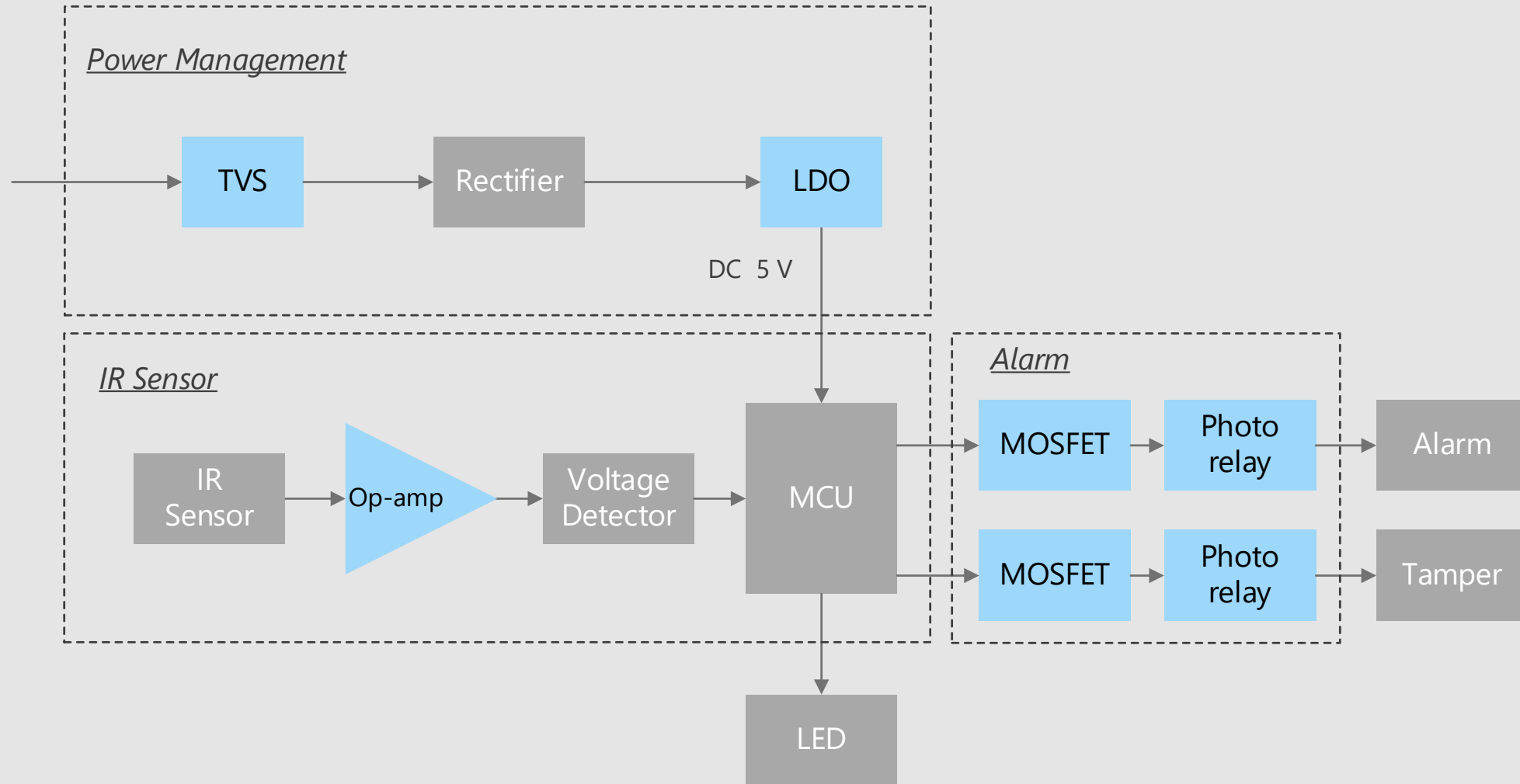

## An example of power supply circuit

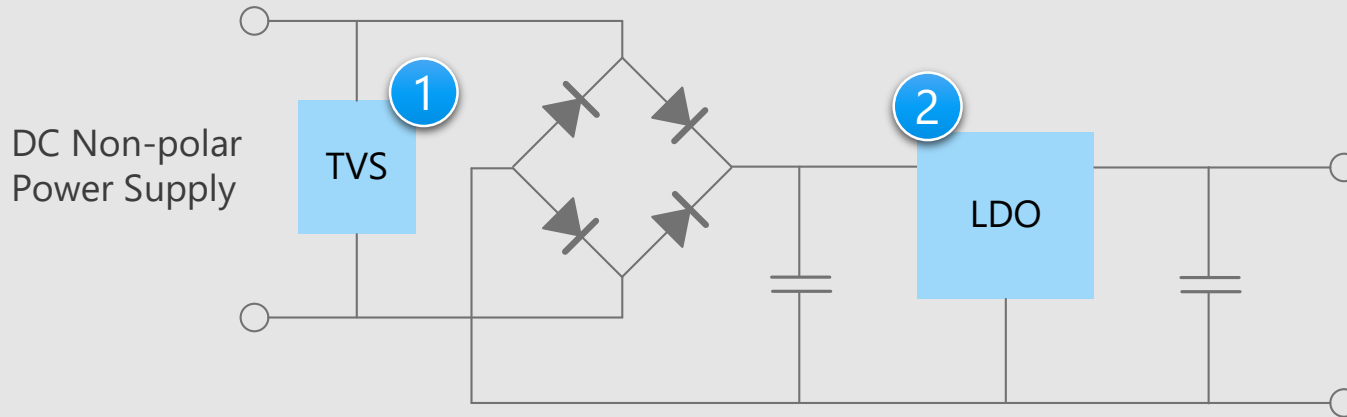

## Criteria for device selection

- Highly ESD resistant and reliable system design is possible.
- The board area can be reduced by adopting a small package product.

## Proposal from Toshiba

- **Realizes high ESD tolerance and space saving.**  
TVS diode 1
- **Space saving and low dropout voltage.**  
Small surface mount LDO regulator 2

\* Click on the numbers in the circuit diagram to jump to the detailed descriptions page

## An example of sensor circuit

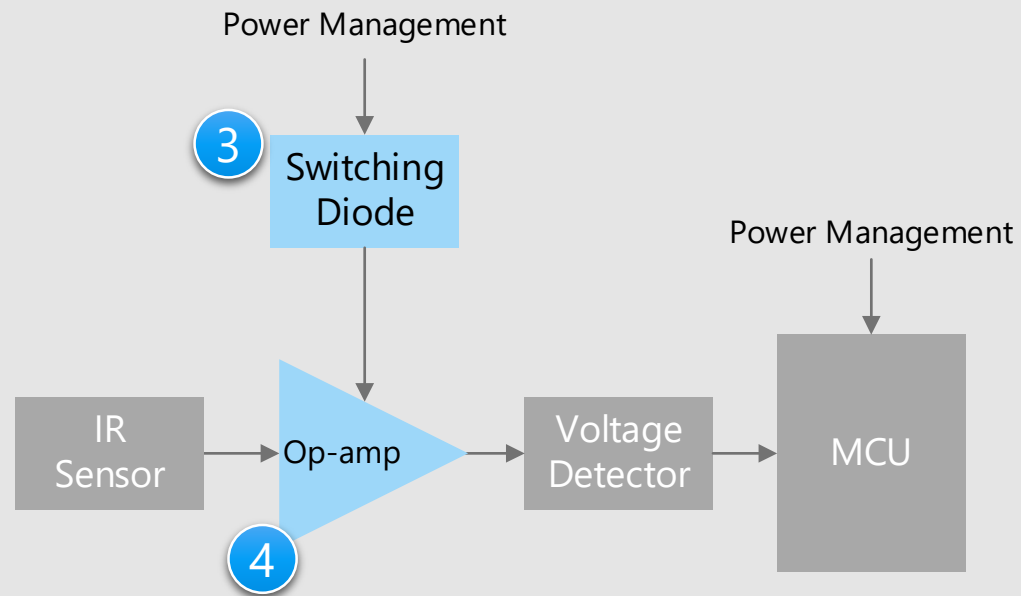

\* [Click on the numbers in the circuit diagram to jump to the detailed descriptions page](#)

## Criteria for device selection

- High-speed switching characteristic supports high frequency operation.
- Low power consumption is realized by operating at low voltage / current consumption.
- An operational amplifier with low offset characteristics and low noise characteristics is required for high-precision sensing.

## Proposal from Toshiba

- **High speed switching**  
Switching diode 3
- **Low noise operational amplifier with low  $V_{IO}$**   
Low current consumption op-amp /  
Low noise op-amp 4

# Motion Detector Detail of alarm circuit

## An example of alarm circuit

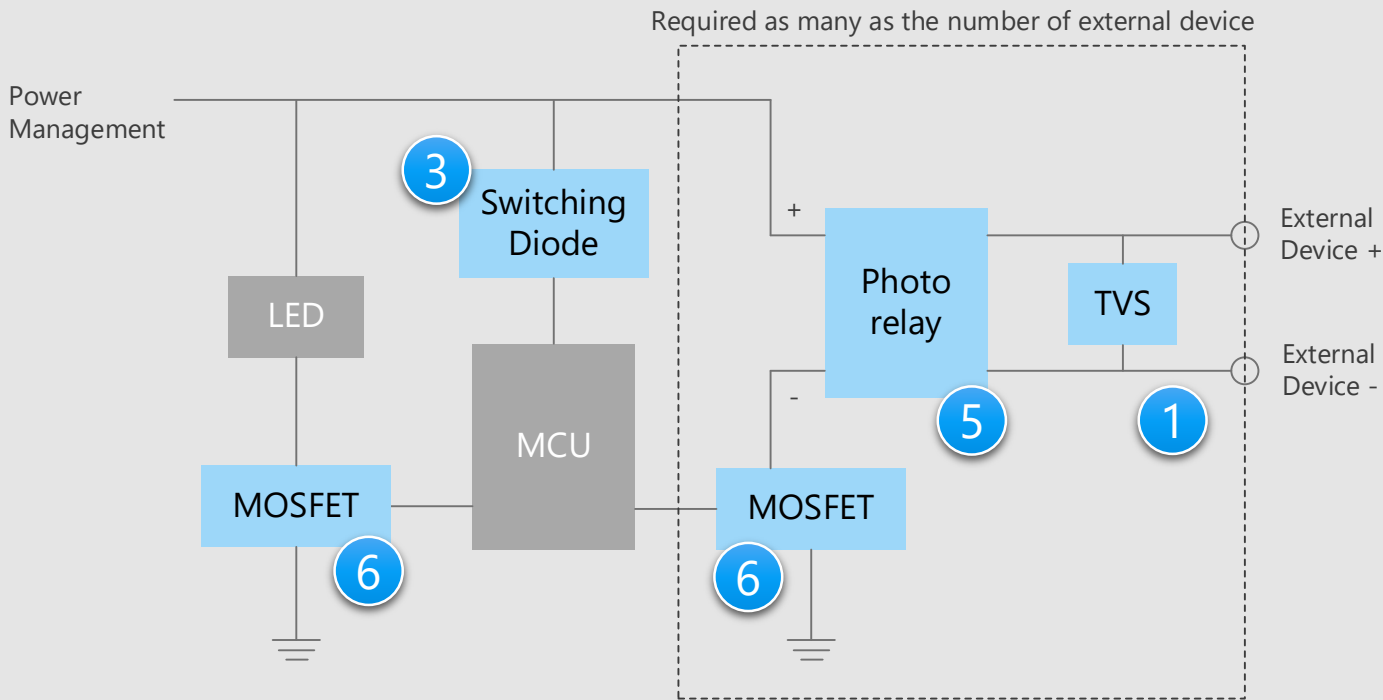

\* Click on the numbers in the circuit diagram to jump to the detailed descriptions page

## Criteria for device selection

- By using a photorelay instead of a mechanical relay, the life limit due to wear or welding of the contact portion is eliminated, enabling a longer life and quieter operation.
- In addition, the board area can be reduced by adopting a small package product.

## Proposal from Toshiba

- **Realizes high ESD tolerance and space saving.** 1  
TVS diode
- **High speed switching** 3  
Switching diode
- **Suitable for replacement of mechanical relays.** 5  
Photorelay
- **A MOSFET that can be driven at low voltages.** 6  
Small signal MOSFET

# Recommended Devices

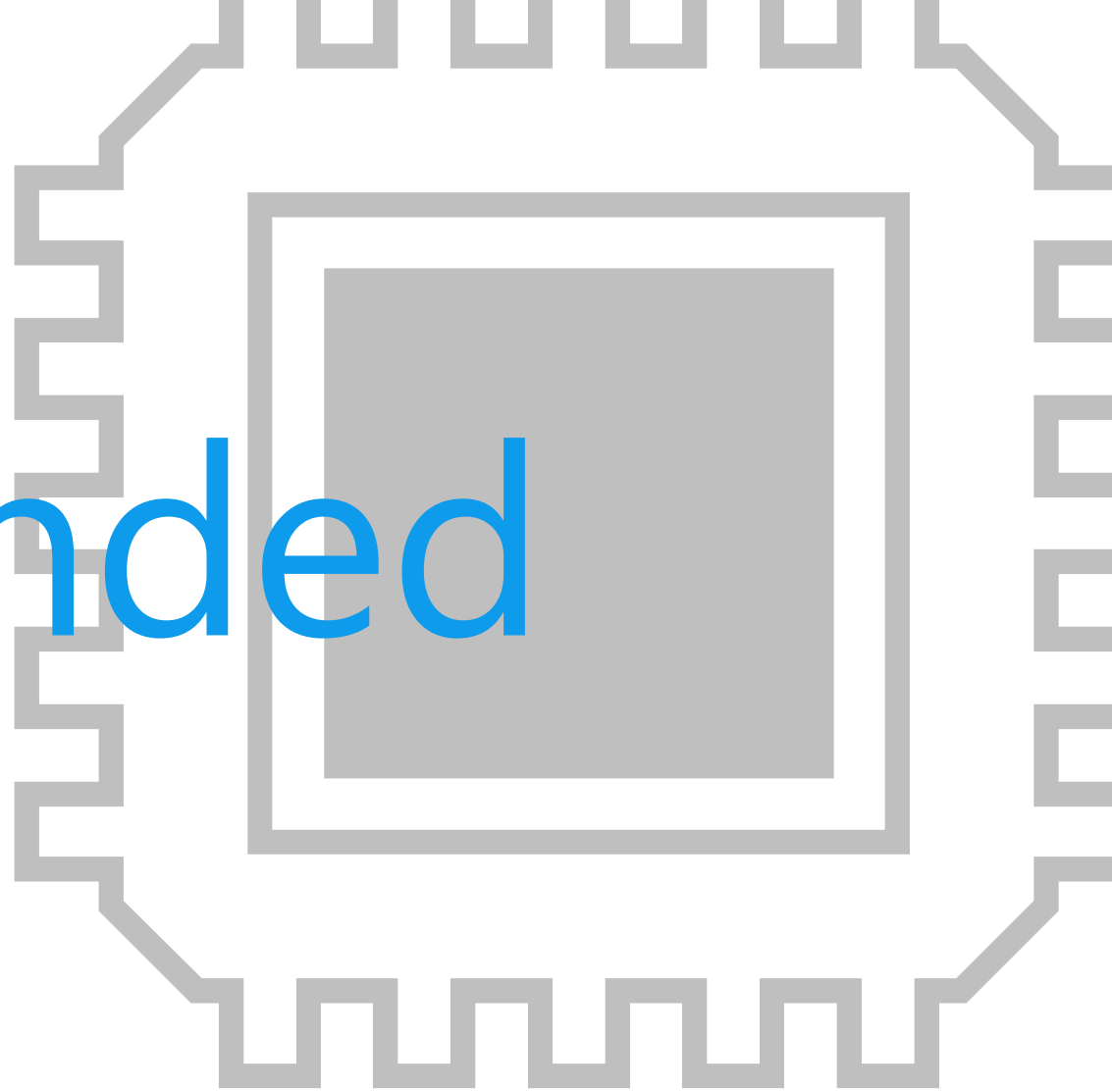



# Device solutions to address customer needs

As described above, in the design of motion sensor, "**Miniaturization of circuit boards**", "**Low power consumption of sets**" and "**Robust operation**" are important factors. Toshiba's proposals are based on these three solution perspectives.

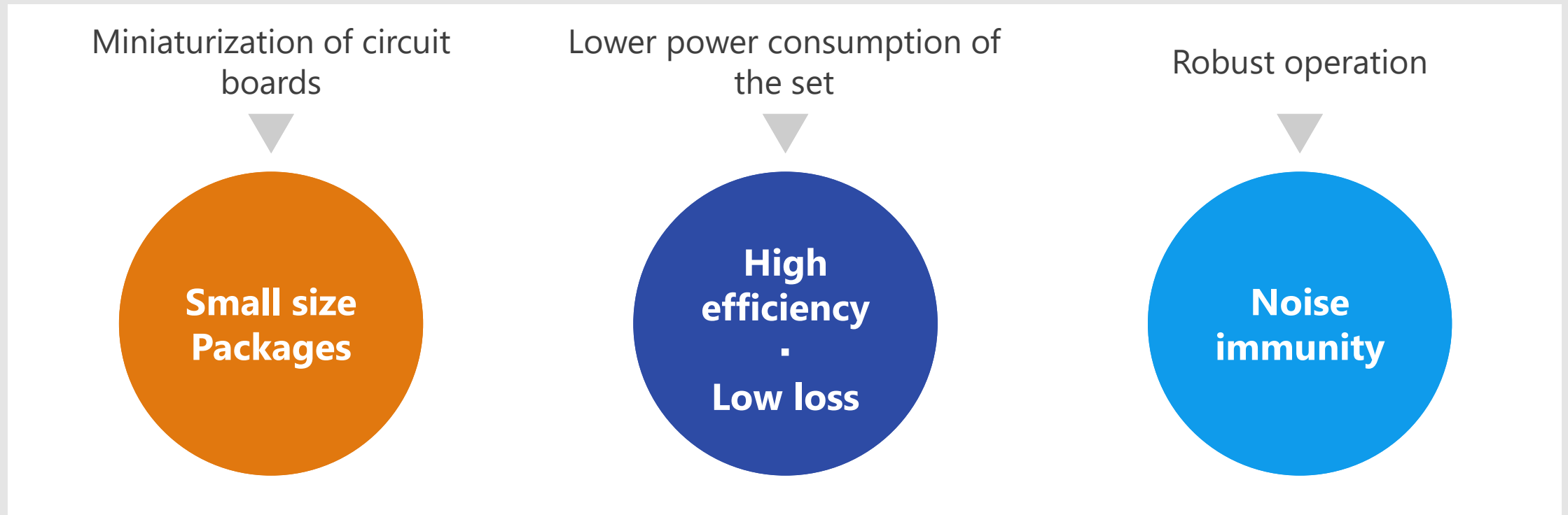

# Device solutions to address customer needs

Small size packages

High efficiency  
·  
Low loss

Noise immunity

① TVS diode	●		●
② Small surface mount LDO regulator	●	●	●
③ Switching diode	●		
④ Low current consumption op-amp / Low noise op-amp	●	●	
⑤ Photorelay	●	●	●
⑥ Small signal MOSFET	●	●	

Value provided

**Absorbs static electricity (ESD) from external terminals, prevents circuit malfunction, and protects devices.**

## 1 Improved ESD pulse absorption

Improved ESD absorption compared to our conventional products. (50 % reduction in operating resistance)  
For some products, both low operating resistance and low capacitance are realized and ensures high signal protection performance and signal quality.

## 2 Suppress ESD energy by low clamp voltage

Steadily protect the connected circuits/devices using proprietary technology.

## 3 Suitable for high-density mounting

A variety of compact packages are available.

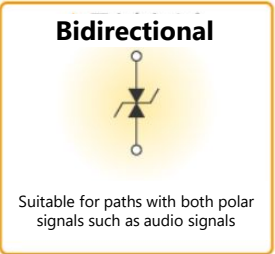
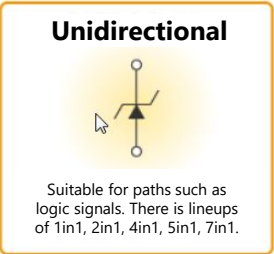
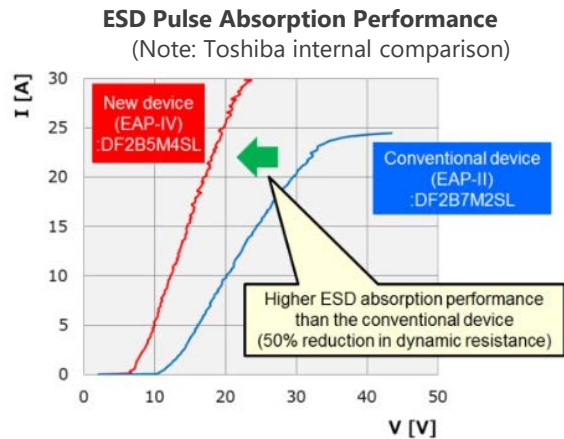

Line up

Part number	DF2B29FU	DF2S23P2FU	DF2S23P2CTC
Package	SOD-323 (USC)		SOD-963 (CST2C)
$V_{ESD}$ [kV]	±25	±30	
$V_{RWM}$ (Max) [V]	±24	21	
$C_t$ (Typ.) [pF]	9	160	
$R_{DYN}$ (Typ.) [ $\Omega$ ]	1.1	0.13	

Note : This product is designed for ESD protection purpose and cannot be used for purposes other than ESD protection.

[Return to Block Diagram TOP](#)

# 2 Small surface mount LDO regulator

TAR5S50U / TAR5S50 / TAR5SB50

Small size packages

High efficiency  
Low loss

Noise immunity

Value provided

Wide line up from general-purpose type to small package type are provided. Contribute to realize a stable power supply not affected by fluctuation of battery.

## 1 Low dropout voltage

Dropout characteristics have been greatly improved by the newly developed process.(50 % improvement : Toshiba comparison)

## 2 High PSRR

With a high PSRR (Power Supply Rejection Ratio), ripple is efficiently removed.

## 3 Can be used with ceramic capacitors

With improved dropout characteristics, it is now possible to use ceramic capacitors for external capacitor functions.

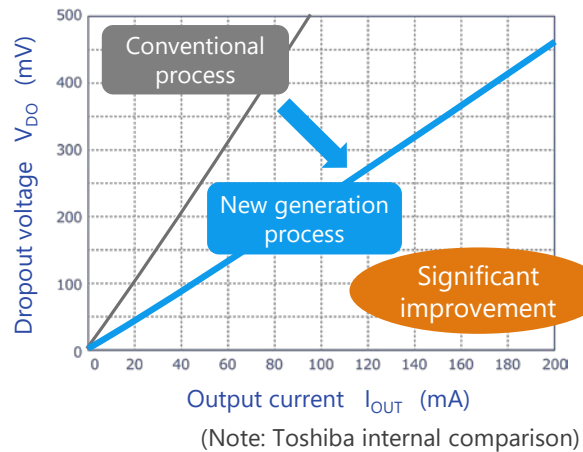

### Low dropout voltage

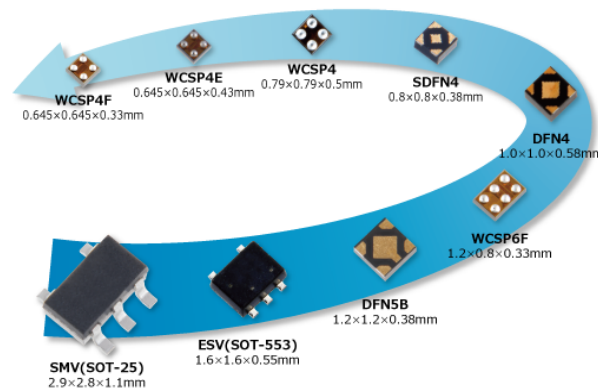

### Rich package line up



### Line up

Part number	TAR5S50U	TAR5S50	TAR5SB50
Package	SOT-353F (UFV) 	SOT-25 (SMV) 	
$V_{IN}$ [V]	2.4 to 15		
$I_{OUT}$ (Max) [mA]	200		
$V_{DO}$ (Typ.) [mV]	130		
PSRR (Typ.) [dB]	70		
$I_{B(ON)}$ (Typ.) [ $\mu$ A]	170		

[Return to Block Diagram TOP](#)

# 3 Switching diode

1SS181 / 1SS184 / 1SS352 / 1SS387 / 1SS302A

Small size packages

High efficiency  
Low loss

Noise immunity

Value provided

Wide range of products are provided, mainly compact package that is suitable for high-density assembly.

## 1 Surface mount / compact package

Adopting S-mini / USC / ESC / USM package which is lower in height compared to the conventional lead type contributes to the space saving of the equipment.

## 2 Wide product line up (1)

Reverse voltage : 20 to 100 V  
Average forward current : 100 mA  
Suitable product can be selected according to requirements.



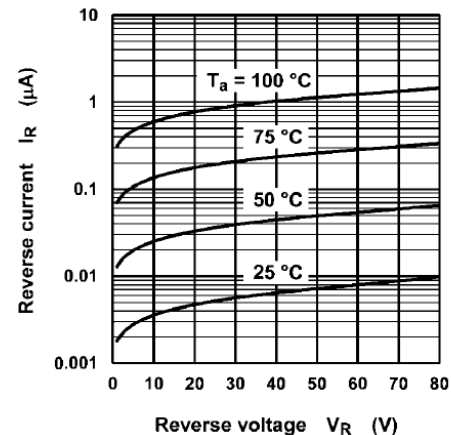
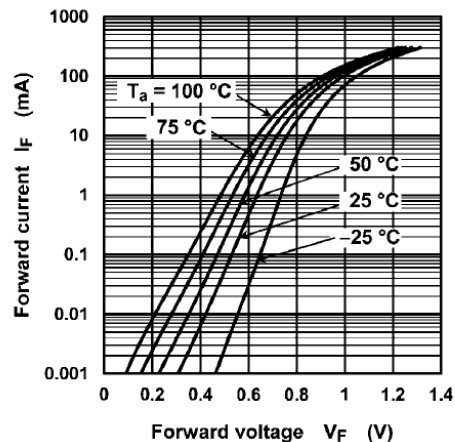

## 3 Wide product line up (2)

For protection of inductive load of mechanical relay, diodes with low voltage and small package are also provided.

Examples of 1SS302A's characteristics



Line up

Part number	1SS181	1SS184	1SS352	1SS387	1SS302A
Package	 S-Mini		 USC	 ESC	 USM
$I_O$ (Max) [mA]	100	100	100	100	100
$V_R$ (Max) [V]	80	80	80	80	80

[Return to Block Diagram TOP](#)

Value provided

## Low current consumption type and low noise type operational amplifiers maximize the performance of system.

### 1 Low voltage operation

We have a lineup of low power supply voltage-driven operational amplifiers using CMOS process for low power supply voltage-driven equipment.

### 2 Low current consumption (TC75S102F) $I_{DD} = 0.27$ [μA] (Typ.)

CMOS processes have been used to achieve lower current consumption. This contributes to lower power consumption.

### 3 Low noise (TC75S67TU) $V_{NI} = 6.0$ [nV/√Hz] (Typ.) @f=1 kHz

This CMOS operational amplifier can amplify minute signals detected by various sensors [1] with very low noises. By optimizing the process, we have achieved the industry's top-level [2] low equivalent input noise voltage.

[Note 1] Sensor types: vibration, shock, acceleration, pressure, infrared, temperature, etc.  
[Note 2] As of May 2017

#### TC75S102F

Current Consumption Characteristic  
(Note: Toshiba internal comparison)

Low current consumption product TC75S102F

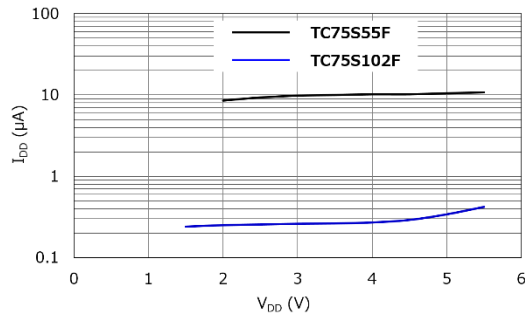

#### TC75S67TU



Noise Characteristic  
(Note: Toshiba internal comparison)

Reduce 1/f noise (10 Hz) by 86 % from our normal products

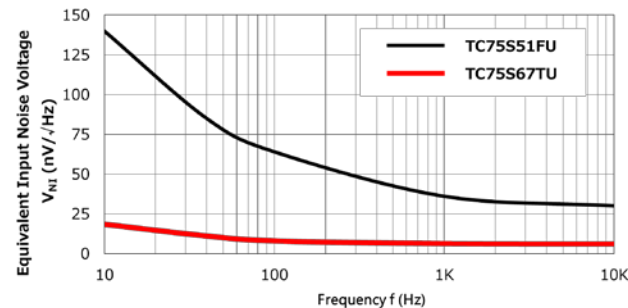
$V_{NI} - f$  @Ta=25 °C,  $V_{DD}=3.3$  V



#### Line up

Part number	TC75S102F	TC75S67TU
Package	SMV 	UFV 
$V_{DD} - V_{SS}$ [V]	1.5 to 5.5	2.2 to 5.5
$V_{IO}$ (Max) [mV]	1.3	3
$CMV_{IN}$ (Max) [V]	$V_{DD}$	1.4 (@ $V_{DD} = 2.5$ V)
$I_{DD}$ (Typ. / Max) [μA]	0.27 / 0.46 (@ $V_{DD}=1.5$ V)	430 / 700 (@ $V_{DD} = 2.5$ V)
$V_{NI}$ (Typ.) [nV/√Hz] @f = 1 kHz	-	6

[Return to Block Diagram TOP](#)

Value provided

Photorelays are composed of infrared light emitting diodes that are optically coupled to photo MOSFETs, are resistant to noise, and low current consumption, suitable for use in motion detectors.

## 1 Low on-resistance $R_{ON}$

Low on-resistance  $R_{ON}$  contributes to realize low power consumption of set.

## 2 Low trigger current $I_{FT}$

The trigger current  $I_{FT}$  of TLP171A is 0.2 mA (Max).  
Low  $I_{FT}$  contributes to design with low drive current.

## 3 Many types of package

Many types of package for reducing of size of set and improving freedom of design are provided.

TLP170AM  
Internal circuit

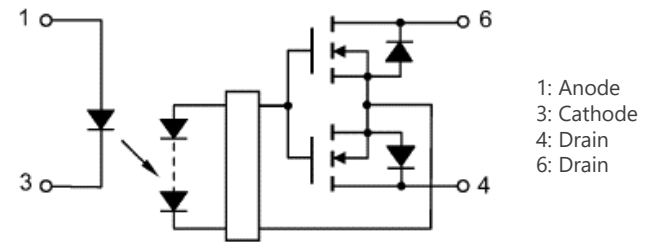

Safety standard  
All 4 parts  
UL-recognized: UL1577, File No.E67349  
cUL-recognized: CSA Component Acceptance Service No.5A File No.E67349  
VDE-approved: EN 60747-5-5

only for TLP240A  
UL-recognized: UL 508, File No.E499232  
CQC-approved: GB4943.1, GB8898  
VDE-approved: EN 62368-1

Line up				
Part number	TLP170AM	TLP171A	TLP240A	TLP241B
Package	4pin SO6	2.54 SOP4	DIP4	
$I_{ON}$ (Max) [A]	0.7	0.4	0.5	2.0
$V_{OFF}$ (Max) [V]	60	60	60	100
$R_{ON}$ (Max) [ $\Omega$ ]	0.3	2	2	0.2
$I_{FT}$ (Max) [mA]	1	0.2	3	3
$BV_S$ (Min) [Vrms]	3750	1500	5000	5000

[Return to Block Diagram TOP](#)

Value provided

Suitable for high speed switching and greatly contributes to miniaturization.

## 1 Low voltage operation

Drive at low  $V_{GS}$   
 SSM3K15ACTC / SSM3K16CTC : 1.5 V drive  
 SSM3K35AFS / SSM3K35AMFV : 1.2 V drive

## 2 Low on-resistance

By keeping the on-resistance between the source and drain low, heat generation and power consumption can be kept low.

## 3 Small size packages

Products with small size package such as CST3C, SSM and VESM are provided.

SSM3K15ACTC / SSM3K16CTC  
Internal circuit diagram

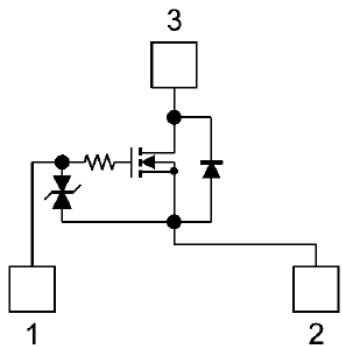

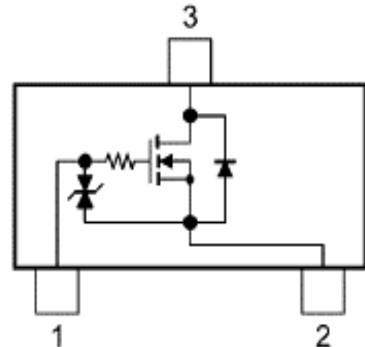

SSM3K35AFS / SSM3K35AMFV  
Internal circuit diagram



1: Gate  
2: Source  
3: Drain

### Line up

Part number	SSM3K15ACTC	SSM3K16CTC	SSM3K35AFS	SSM3K35AMFV
Package	CST3C 		SSM 	VESM 
Polarity	N-ch	N-ch	N-ch	N-ch
$V_{DSS}$ [V]	30	20	20	20
$I_D$ [mA]	100	200	250	250
$R_{DS(ON)}$ (Max) [ $\Omega$ ] @ $V_{GS} = 2.5$ V	6	3	1.6	1.6

[Return to Block Diagram TOP](#)



If you are interested in these products and have questions or comments about any of them, please do not hesitate to contact us below:

Contact address: <https://oshiba.semicon-storage.com/ap-en/contact.html>



# Terms of use

This terms of use is made between Toshiba Electronic Devices and Storage Corporation ("We") and customers who use documents and data that are consulted to design electronics applications on which our semiconductor devices are mounted ("this Reference Design"). Customers shall comply with this terms of use. Please note that it is assumed that customers agree to any and all this terms of use if customers download this Reference Design. We may, at its sole and exclusive discretion, change, alter, modify, add, and/or remove any part of this terms of use at any time without any prior notice. We may terminate this terms of use at any time and for any reason. Upon termination of this terms of use, customers shall destroy this Reference Design. In the event of any breach thereof by customers, customers shall destroy this Reference Design, and furnish us a written confirmation to prove such destruction.

## 1. Restrictions on usage

- 1.This Reference Design is provided solely as reference data for designing electronics applications. Customers shall not use this Reference Design for any other purpose, including without limitation, verification of reliability.
- 2.This Reference Design is for customer's own use and not for sale, lease or other transfer.
- 3.Customers shall not use this Reference Design for evaluation in high or low temperature, high humidity, or high electromagnetic environments.
- 4.This Reference Design shall not be used for or incorporated into any products or systems whose manufacture, use, or sale is prohibited under any applicable laws or regulations.

## 2. Limitations

- 1.We reserve the right to make changes to this Reference Design without notice.
- 2.This Reference Design should be treated as a reference only. We are not responsible for any incorrect or incomplete data and information.
- 3.Semiconductor devices can malfunction or fail. When designing electronics applications by referring to this Reference Design, customers are responsible for complying with safety standards and for providing adequate designs and safeguards for their hardware, software and systems which minimize risk and avoid situations in which a malfunction or failure of semiconductor devices could cause loss of human life, bodily injury or damage to property, including data loss or corruption. Customers must also refer to and comply with the latest versions of all relevant our information, including without limitation, specifications, data sheets and application notes for semiconductor devices, as well as the precautions and conditions set forth in the "Semiconductor Reliability Handbook".
- 4.When designing electronics applications by referring to this Reference Design, customers must evaluate the whole system adequately. Customers are solely responsible for all aspects of their own product design or applications. WE ASSUME NO LIABILITY FOR CUSTOMERS' PRODUCT DESIGN OR APPLICATIONS.
- 5.No responsibility is assumed by us for any infringement of patents or any other intellectual property rights of third parties that may result from the use of this Reference Design. No license to any intellectual property right is granted by this terms of use, whether express or implied, by estoppel or otherwise.
- 6.THIS REFERENCE DESIGN IS PROVIDED "AS IS". WE (a) ASSUME NO LIABILITY WHATSOEVER, INCLUDING WITHOUT LIMITATION, INDIRECT, CONSEQUENTIAL, SPECIAL, OR INCIDENTAL DAMAGES OR LOSS, INCLUDING WITHOUT LIMITATION, LOSS OF PROFITS, LOSS OF OPPORTUNITIES, BUSINESS INTERRUPTION AND LOSS OF DATA, AND (b) DISCLAIM ANY AND ALL EXPRESS OR IMPLIED WARRANTIES AND CONDITIONS RELATED TO THIS REFERENCE DESIGN, INCLUDING WARRANTIES OR CONDITIONS OF MERCHANTABILITY, FITNESS FOR A PARTICULAR PURPOSE, ACCURACY OF INFORMATION, OR NONINFRINGEMENT.

## 3. Export Control

Customers shall not use or otherwise make available this Reference Design for any military purposes, including without limitation, for the design, development, use, stockpiling or manufacturing of nuclear, chemical, or biological weapons or missile technology products (mass destruction weapons). This Reference Design may be controlled under the applicable export laws and regulations including, without limitation, the Japanese Foreign Exchange and Foreign Trade Law and the U.S. Export Administration Regulations. Export and re-export of this Reference Design are strictly prohibited except in compliance with all applicable export laws and regulations.

## 4. Governing Laws

This terms of use shall be governed and construed by laws of Japan.

# Restrictions on product use

- Toshiba Electronic Devices & Storage Corporation, and its subsidiaries and affiliates (collectively "TOSHIBA"), reserve the right to make changes to the information in this document, and related hardware, software and systems (collectively "Product") without notice.
- This document and any information herein may not be reproduced without prior written permission from TOSHIBA. Even with TOSHIBA's written permission, reproduction is permissible only if reproduction is without alteration/omission.
- Though TOSHIBA works continually to improve Product's quality and reliability, Product can malfunction or fail. Customers are responsible for complying with safety standards and for providing adequate designs and safeguards for their hardware, software and systems which minimize risk and avoid situations in which a malfunction or failure of Product could cause loss of human life, bodily injury or damage to property, including data loss or corruption. Before customers use the Product, create designs including the Product, or incorporate the Product into their own applications, customers must also refer to and comply with (a) the latest versions of all relevant TOSHIBA information, including without limitation, this document, the specifications, the data sheets and application notes for Product and the precautions and conditions set forth in the "TOSHIBA Semiconductor Reliability Handbook" and (b) the instructions for the application with which the Product will be used with or for. Customers are solely responsible for all aspects of their own product design or applications, including but not limited to (a) determining the appropriateness of the use of this Product in such design or applications; (b) evaluating and determining the applicability of any information contained in this document, or in charts, diagrams, programs, algorithms, sample application circuits, or any other referenced documents; and (c) validating all operating parameters for such designs and applications. **TOSHIBA ASSUMES NO LIABILITY FOR CUSTOMERS' PRODUCT DESIGN OR APPLICATIONS..**
- **PRODUCT IS NEITHER INTENDED NOR WARRANTED FOR USE IN EQUIPMENTS OR SYSTEMS THAT REQUIRE EXTRAORDINARILY HIGH LEVELS OF QUALITY AND/OR RELIABILITY, AND/OR A MALFUNCTION OR FAILURE OF WHICH MAY CAUSE LOSS OF HUMAN LIFE, BODILY INJURY, SERIOUS PROPERTY DAMAGE AND/OR SERIOUS PUBLIC IMPACT ("UNINTENDED USE").** Except for specific applications as expressly stated in this document, Unintended Use includes, without limitation, equipment used in nuclear facilities, equipment used in the aerospace industry, lifesaving and/or life supporting medical equipment, equipment used for automobiles, trains, ships and other transportation, traffic signaling equipment, equipment used to control combustions or explosions, safety devices, elevators and escalators, and devices related to power plant. **IF YOU USE PRODUCT FOR UNINTENDED USE, TOSHIBA ASSUMES NO LIABILITY FOR PRODUCT.** For details, please contact your TOSHIBA sales representative or contact us via our website.
- Do not disassemble, analyze, reverse-engineer, alter, modify, translate or copy Product, whether in whole or in part.
- Product shall not be used for or incorporated into any products or systems whose manufacture, use, or sale is prohibited under any applicable laws or regulations.
- The information contained herein is presented only as guidance for Product use. No responsibility is assumed by TOSHIBA for any infringement of patents or any other intellectual property rights of third parties that may result from the use of Product. No license to any intellectual property right is granted by this document, whether express or implied, by estoppel or otherwise.
- **ABSENT A WRITTEN SIGNED AGREEMENT, EXCEPT AS PROVIDED IN THE RELEVANT TERMS AND CONDITIONS OF SALE FOR PRODUCT, AND TO THE MAXIMUM EXTENT ALLOWABLE BY LAW, TOSHIBA (1) ASSUMES NO LIABILITY WHATSOEVER, INCLUDING WITHOUT LIMITATION, INDIRECT, CONSEQUENTIAL, SPECIAL, OR INCIDENTAL DAMAGES OR LOSS, INCLUDING WITHOUT LIMITATION, LOSS OF PROFITS, LOSS OF OPPORTUNITIES, BUSINESS INTERRUPTION AND LOSS OF DATA, AND (2) DISCLAIMS ANY AND ALL EXPRESS OR IMPLIED WARRANTIES AND CONDITIONS RELATED TO SALE, USE OF PRODUCT, OR INFORMATION, INCLUDING WARRANTIES OR CONDITIONS OF MERCHANTABILITY, FITNESS FOR A PARTICULAR PURPOSE, ACCURACY OF INFORMATION, OR NONINFRINGEMENT.**
- Product may include products using GaAs (Gallium Arsenide). GaAs is harmful to humans if consumed or absorbed, whether in the form of dust or vapor. Handle with care and do not break, cut, crush, grind, dissolve chemically or otherwise expose GaAs in Product.
- Do not use or otherwise make available Product or related software or technology for any military purposes, including without limitation, for the design, development, use, stockpiling or manufacturing of nuclear, chemical, or biological weapons or missile technology products (mass destruction weapons). Product and related software and technology may be controlled under the applicable export laws and regulations including, without limitation, the Japanese Foreign Exchange and Foreign Trade Law and the U.S. Export Administration Regulations. Export and re-export of Product or related software or technology are strictly prohibited except in compliance with all applicable export laws and regulations.
- Please contact your TOSHIBA sales representative for details as to environmental matters such as the RoHS compatibility of Product. Please use Product in compliance with all applicable laws and regulations that regulate the inclusion or use of controlled substances, including without limitation, the EU RoHS Directive. **TOSHIBA ASSUMES NO LIABILITY FOR DAMAGES OR LOSSES OCCURRING AS A RESULT OF NONCOMPLIANCE WITH APPLICABLE LAWS AND REGULATIONS.**

# **TOSHIBA**

\* Company names, product names, and service names may be trademarks of their respective companies.