

MN SERIES (Conventional Air design) NAS HDD

Toshiba MN series of 3.5-inch^[1] 7200 rpm hard disk drives (HDD) deliver up to 10 TB^[2] of storage capacity, making it suitable storage solution for home and SOHO NAS applications. To address the demanding requirements, these HDDs provide enterprise class 1 000 000 hour MTTF^[3], 180 TB/year^[4] workload rating and support for 24/7 power-on operation. The MN series also feature rotational vibration (RV) sensors which automatically detect and compensate for transient vibrations to deliver consistent performance in multi-bay storage enclosures.



Product image may represent a design model.

KEY FEATURES

- Up to 10 TB Capacity (model line-up also includes 8 TB, 6 TB and 4 TB)
- 7200 rpm Performance
- SATA 6.0 Gbit/s^{[5][6]} Interface
- MTTF of 1 000 000 hours
- 180 total TB Transferred per Year Workload Rating
- Rotational Vibration (RV) Sensors for Great Scalability and Good Performance
- 24/7 operation

APPLICATIONS

- Home and SOHO NAS
- Small business server and storage
- Archiving and data back-up
- Private cloud storage

SPECIFICATIONS

Item		MN06ACA10T	MN06ACA800
Interface		SATA-3.3	
Formatted Capacity		10 TB	8 TB
Performance	Interface Speed	6.0 Gbit/s, 3.0 Gbit/s, 1.5 Gbit/s	
	Rotation Speed	7200 rpm	
	Buffer Size	256 MiB ^[6]	
	Max Data Transfer Speed (Sustained) (Typ.)	211 to 237 MiB/s	211 to 230 MiB/s
Logical Data Block Length		HOST: 512 B, DISK: 4096 B ^[7]	
Supply Voltage	Allowable Voltage	12 V ^[8] ± 10 % / 5 V ^[8] + 10% / - 5% ^[9]	
Power Consumption	Operating ^[10] (Typ.)	9.48 W	8.61 W
	Active Idle (Typ.)	7.15 W	6.33 W
Acoustics ^[11] (Sound Power)	Active Idle (Typ.)	34 dB	
	Seek (Typ.)	35 dB	

Item		MN06ACA600	MN04ACA400
Interface		SATA-3.3	SATA-2.6/3.0
Formatted Capacity		6 TB	4 TB
Performance	Interface Speed	6.0 Gbit/s, 3.0 Gbit/s, 1.5 Gbit/s	6.0 Gbit/s, 3.0 Gbit/s, 1.5 Gbit/s
	Rotation Speed	7200 rpm	7200 rpm
	Buffer Size	256 MiB	128 MiB
	Max Data Transfer Speed (Sustained) (Typ.)	211 to 230 MiB/s	185 to 195 MiB/s
Logical Data Block Length		HOST: 512 B, DISK: 4096 B ^[7]	HOST: 512 B DISK: 512 B or 4096 B ^[7]
Supply Voltage	Allowable Voltage	12 V ^[8] ± 10 % 5 V ^[8] + 10% / - 5% ^[9]	12 V ^[8] ± 10 % 5 V ^[8] ± 5% ^[9]
Power Consumption	Operating ^[10] (Typ.)	7.88 W	9.6 W
	Active Idle (Typ.)	5.59 W	5.2 W
Acoustics ^[11] (Sound Power)	Active Idle (Typ.)	34 dB	30 dB
	Seek (Typ.)	35 dB	34 dB

ENVIRONMENTAL LIMITS

Item		MN06ACA10T MN06ACA800 MN06ACA600	MN04ACA400
Temperature	Operating (ambient)	0 °C to 60 °C	
	Operating (surface)	0 °C to 65 °C	
	Non-Operating (ambient)	- 40 °C to 70 °C ^[15]	
Humidity	Operating	5 % to 90 % R.H. (No condensation)	
	Non-Operating	5 % to 95 % R.H. (No condensation)	
Shock	Operating	686 m/s ² { 70 G } (2 ms duration)	
	Non-Operating	2450 m/s ² { 250 G } (2 ms duration)	
Vibration ^[12]	Operating ^[13]	7.35 m/s ² { 0.75 G } (5 to 300 Hz) 2.45 m/s ² { 0.25 G } (300 to 500 Hz)	
	Non-Operating ^[14]	29.4 m/s ² { 3.0 G } (5 to 500 Hz)	49 m/s ² { 5 G } (5 to 500 Hz)
Altitude	Operating	- 305 m to 3048 m	
	Non-Operating	- 305 m to 12 192 m	

RELIABILITY

Item	Specification
MTTF	1 000 000 h
Non-recoverable Error Rate	1 error per 10 ¹⁴ bits read
Load / Unload (Max)	300 000 times
Availability	24 hours/day, 7 days/week
Rated Annual Workload (Total TB Transferred per Year, R/W)	180 TB/year

[1] "3.5-inch" mean the form factor of HDDs. They do not indicate drive's physical size.

[2] Definition of capacity: Toshiba defines a terabyte (TB) as 1 000 000 000 000 bytes. A computer operating system, however, reports storage capacity using powers of 2 for the definition of 1TB = 2⁴⁰ = 1 099 511 627 776 bytes and therefore shows less storage capacity. Available storage capacity (including examples of various media files) will vary based on file size, formatting, settings, software and operating system, such as Microsoft Operating System and/or pre-installed software applications, or media content. Actual formatted capacity may vary.

[3] MTTF (Mean Time to Failure) is not a guarantee or estimate of product life; it is a statistical value related to mean failure rates for a large number of products which may not accurately reflect actual operation. Actual operating life of the product may be different from the MTTF.

[4] Workload is defined as the amount of data written, read or verified by commands from host system.

[5] Read and write speed may vary depending on the host device, read and write conditions, and file size.

[6] A mebibyte (MiB) means 2²⁰, or 1 048 576 bytes, and a gibibyte (GiB) means 2³⁰, or 1 073 741 824 bytes.

[7] Read-modify-write is supported.

[8] Input voltages are specified at the HDD connector side, during HDD ready state.

[9] Make sure the value is not less than DC -0.3 V (less than -0.6 V, 0.1 ms) when turning on or off the power.

[10] Operating watt is measured using 80% random read/write and 20% performance idle.

[11] The measuring method is based on ISO 7779.

[12] Vibration applied to the HDD is measured at near the mounting screw hole on the frame as much as possible.

[13] At random seek write/read and default on retry setting with log sweep vibration.

[14] At power-off state after installation.

[15] The range of altitude is 3 048 m or less.

Up to 55 °C at 7620 m. Up to 40 °C at 12 192 m.

MARKING

1) WEEE

Following information is only for EU-member states:

The use of the symbol indicates that this product may not be treated as household waste. By ensuring this product is disposed of correctly, you will help prevent potential negative consequences for the environment and human health, which could otherwise be caused by inappropriate waste handling of this product. For more detailed information about recycling of this product, please contact your local city office, your household waste disposal service or the shop where you purchased the product.



2) Names and Contents of Hazardous Substances or Elements in Products

产品中有害物质的名称及含量

部件名称	有害物质					
	铅 (Pb)	汞 (Hg)	镉 (Cd)	六价铬 (Cr(VI))	多溴联苯 (PBB)	多溴二苯 (PBDE)
HDD(硬盘驱动器)	×	○	○	○	○	○

本表格依据 SJ/T 11364 的规定编制。

○：表示该有害物质在该部件所有均质材料中的含量均在 GB/T 26572 规定的限量要求以下。

×：表示该有害物质至少在该部件的某一均质材料中的含量超出 GB/T 26572 规定的限量要求。









中华人民共和国环保使用期限

Safety/EMC Standards

The drive satisfies the following standards.

Item
Underwriters Laboratories (UL)
Canadian Standard Association (CSA)
Technischer Überwachungs-Verein (TUV)
Bureau of Standards, Metrology and Inspection (BSMI)
Ministry of Science, ICT & Future Planning (MSIP) (Note 1)
Australian Communication and Media Authority (ACMA)

(Note 1) Marks of KC

<p>Made in Japan</p>	 <ol style="list-style-type: none"> 1. 기기의 명칭(모델명) : MN06ACA10T 2. 인증번호 : MSIP-REM-TSD-MG06ACA10TE 3. 인증받은 자의 상호 : TOSHIBA ELECTRONIC DEVICES & STORAGE CORPORATION 4. 제조년월일 : 2016-12 5. 제조자 / 제조국가 : TOSHIBA ELECTRONIC DEVICES & STORAGE CORPORATION / 일본  <ol style="list-style-type: none"> 1. 기기의 명칭(모델명) : MN06ACA800 2. 인증번호 : MSIP-REM-TSD-MG06ACA10TE 3. 인증받은 자의 상호 : TOSHIBA ELECTRONIC DEVICES & STORAGE CORPORATION 4. 제조년월일 : 2016-12 5. 제조자 / 제조국가 : TOSHIBA ELECTRONIC DEVICES & STORAGE CORPORATION / 일본  <ol style="list-style-type: none"> 1. 기기의 명칭(모델명) : MN06ACA600 2. 인증번호 : MSIP-REM-TSD-MG06ACA10TE 3. 인증받은 자의 상호 : TOSHIBA ELECTRONIC DEVICES & STORAGE CORPORATION 4. 제조년월일 : 2016-12 5. 제조자 / 제조국가 : TOSHIBA ELECTRONIC DEVICES & STORAGE CORPORATION / 일본  <ol style="list-style-type: none"> 1. 기기의 명칭(모델명) : MN04ACA400 2. 인증번호 : MSIP-REM-TSD-MG04ACP500E 3. 인증받은 자의 상호 : TOSHIBA ELECTRONIC DEVICES & STORAGE CORPORATION 4. 제조년월일 : 2013-10 5. 제조자 / 제조국가 : TOSHIBA ELECTRONIC DEVICES & STORAGE CORPORATION / 일본
<p>Made in Philippines</p>	 <ol style="list-style-type: none"> 1. 기기의 명칭(모델명) : MN06ACA10T 2. 인증번호 : MSIP-REM-TSD-MG06ACA10TE 3. 인증받은 자의 상호 : TOSHIBA ELECTRONIC DEVICES & STORAGE CORPORATION 4. 제조년월일 : 2016-12 5. 제조자 / 제조국가 : TOSHIBA ELECTRONIC DEVICES & STORAGE CORPORATION / 필리핀  <ol style="list-style-type: none"> 1. 기기의 명칭(모델명) : MN06ACA800 2. 인증번호 : MSIP-REM-TSD-MG06ACA10TE 3. 인증받은 자의 상호 : TOSHIBA ELECTRONIC DEVICES & STORAGE CORPORATION 4. 제조년월일 : 2016-12 5. 제조자 / 제조국가 : TOSHIBA ELECTRONIC DEVICES & STORAGE CORPORATION / 필리핀  <ol style="list-style-type: none"> 1. 기기의 명칭(모델명) : MN06ACA600 2. 인증번호 : MSIP-REM-TSD-MG06ACA10TE 3. 인증받은 자의 상호 : TOSHIBA ELECTRONIC DEVICES & STORAGE CORPORATION 4. 제조년월일 : 2016-12 5. 제조자 / 제조국가 : TOSHIBA ELECTRONIC DEVICES & STORAGE CORPORATION / 필리핀  <ol style="list-style-type: none"> 1. 기기의 명칭(모델명) : MN04ACA400 2. 인증번호 : MSIP-REM-TSD-MG04ACP500E 3. 인증받은 자의 상호 : TOSHIBA ELECTRONIC DEVICES & STORAGE CORPORATION 4. 제조년월일 : 2013-10 5. 제조자 / 제조국가 : TOSHIBA ELECTRONIC DEVICES & STORAGE CORPORATION / 필리핀

B급 기기 (가정용 방송통신기자재)	이 기기는 가정용(B급) 전자파적합기기로서 주로 가정에서 사용하는 것을 목적으로 하며, 모든 지역에서 사용할 수 있습니다.
------------------------	--

Item	MN04ACA400
Width (Max)	101.85 mm
Height (Max)	26.1 mm
Length (Max)	147 mm
Weight (Max)	720 g

MN04ACA400

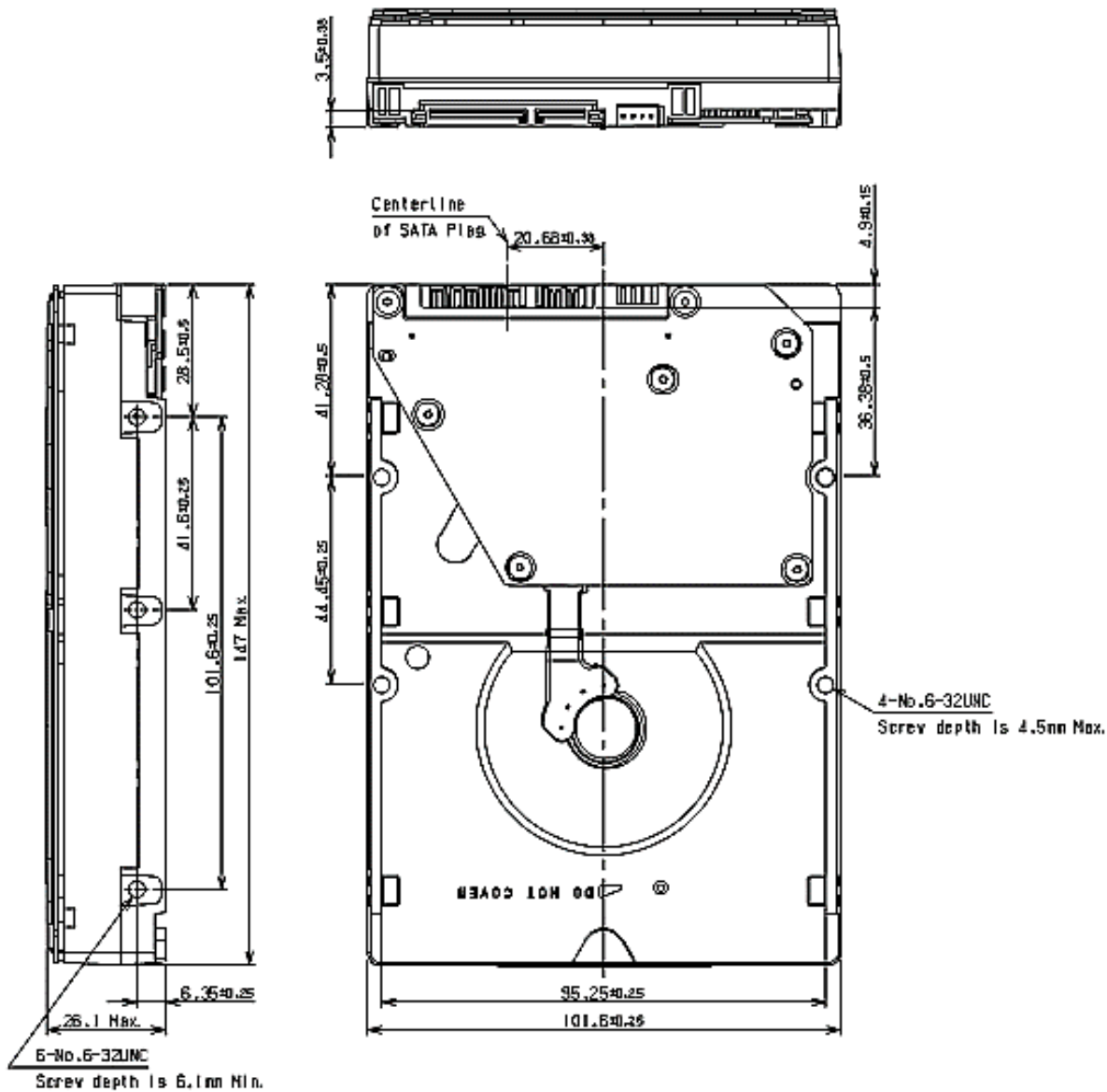

[Unit: mm]
(Reference)

INTERFACE CONNECTOR

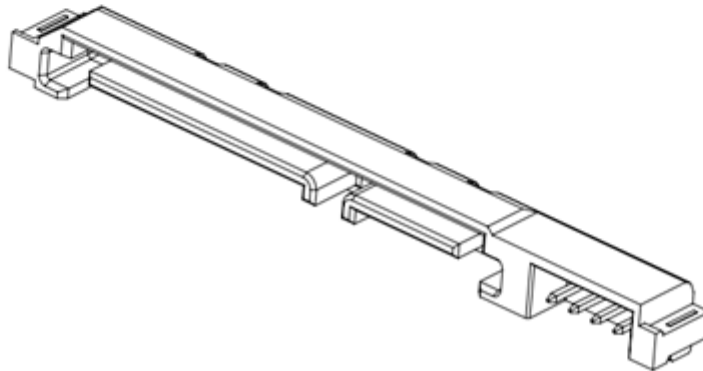
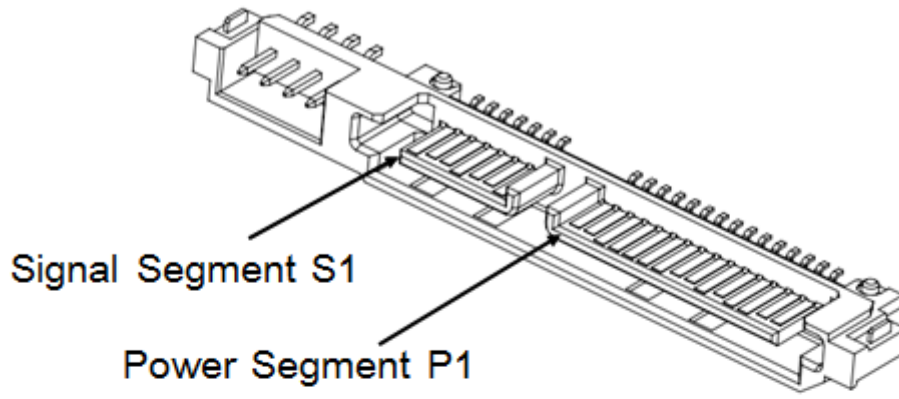

INTERFACE CONNECTOR (SATA plug) SIGNAL ALLOCATION

Segment	Pin No.	Pin Definition	
Signal Segment	S1	GND	2 nd Mate
	S2	A+	Differential Pair A from PHY
	S3	A-	
	S4	GND	2 nd Mate
	S5	B-	Differential Pair B from PHY
	S6	B+	
	S7	GND	2 nd Mate
Power Segment	P1	-	(Unused)
	P2	-	(Unused)
	P3	-	(Unused) : MN04ACA400,
		PWDIS	Enter/Exit Power Disable (Option) : MN06ACA10T, MN06ACA800, MN06ACA600
	P4	GND	1 st Mate
	P5	GND	2 nd Mate
	P6	GND	2 nd Mate
	P7	V5	5 V Power Pre-Charge 2 nd Mate
	P8	V5	5 V Power
	P9	V5	5 V Power
	P10	GND	2 nd Mate
	P11	Spin	- Staggered Spin-up Mode Detect (Input)
		ACT	- Activity LED Drive (Output)
	P12	GND	1 st Mate
	P13	V12	12 V Power Pre-Charge 2 nd Mate
P14	V12	12 V Power	
P15	V12	12 V Power	

Notice: This drive uses 5 V and 12 V power. 3.3 V power is not used.
HDA (Head Disk Assembly) and DC ground (ground pins on interface) are connected electrically each other.

COMMAND TABLE (Part 1)

Op-Code	Command Name	MN06ACA10T MN06ACA800 MN06ACA600	MN04ACA400
E5h/98h	CHECK POWER MODE	√	√
B1h	DEVICE CONFIGURATION	-	√
92h	DOWNLOAD MICROCODE	√	√
93h	DOWNLOAD MICROCODE DMA	√	√
90h	EXECUTE DIAGNOSTICS	√	√
E7h	FLUSH CACHE	√	√
EAh	FLUSH CACHE EXT	√	√
ECh	IDENTIFY DEVICE	√	√
E3h/97h	IDLE	√	√
E1h/95h	IDLE IMMEDIATE	√	√
91h	INITIALIZE DEVICE PARAMETERS	√	√
00h	NOP	√	√
E4h	READ BUFFER	√	√
C8h	READ DMA	√	√
25h	READ DMA EXT	√	√
60h	READ FPDMA QUEUED	√	√
2Fh	READ LOG EXT	√	√
47h	READ LOG DMA EXT	√	√
C4h	READ MULTIPLE	√	√
29h	READ MULTIPLE EXT	√	√
F8h	READ NATIVE MAX ADDRESS	√	√
27h	READ NATIVE MAX ADDRESS EXT	√	√
20h	READ SECTOR(S)	√	√
24h	READ SECTOR(S) EXT	√	√
40h	READ VERIFY SECTOR(S)	√	√
42h	READ VERIFY SECTOR(S) EXT	√	√

COMMAND TABLE (Part 2)

Op-Code	Command Name	MN06ACA10T MN06ACA800 MN06ACA600	MN04ACA400
1xh	RECALIBRATE	√	√
0Bh	REQUEST SENSE DATA EXT	√	-
B4h	SANITIZE DEVICE	√	-
F1h	SECURITY SET PASSWORD	√	√
F2h	SECURITY UNLOCK	√	√
F3h	SECURITY ERASE PREPARE	√	√
F4h	SECURITY ERASE UNIT	√	√
F5h	SECURITY FREEZE LOCK	√	√
F6h	SECURITY DISABLE PASSWORD	√	√
70h – 76h, 79h – 7Fh	SEEK	√	√
77h	SET DATE & TIME EXT	√	-
EFh	SET FEATURES	√	√
F9h	SET MAX	√	√
37h	SET MAX ADDRESS EXT	√	√
C6h	SET MULTIPLE MODE	√	√
E6h/99h	SLEEP	√	√
B0h	SMART Function Set	√	√
E2h/96h	STANDBY	√	√
E0h/94h	STANDBY IMMEDIATE	√	√
E8h	WRITE BUFFER	√	√
CAh	WRITE DMA	√	√
35h	WRITE DMA EXT	√	√
3Dh	WRITE DMA FUA EXT	√	√
61h	WRITE FPDMA QUEUED	√	√
3Fh	WRITE LOG EXT	√	√
57h	WRITE LOG DMA EXT	√	√
C5h	WRITE MULTIPLE	√	√
39h	WRITE MULTIPLE EXT	√	√
CEh	WRITE MULTIPLE FUA EXT	√	√
30h	WRITE SECTOR(S)	√	√
34h	WRITE SECTOR(S) EXT	√	√
45h	WRITE UNCORRECTABLE EXT	√	√
3Ch	WRITE VERIFY	√	√

RESTRICTIONS ON PRODUCT USE

Toshiba Corporation and its subsidiaries and affiliates are collectively referred to as "TOSHIBA". Hardware, software and systems described in this document are collectively referred to as "Product".

- TOSHIBA reserves the right to make changes to the information in this document and related Product without notice.
- This document and any information herein may not be reproduced without prior written permission from TOSHIBA. Even with TOSHIBA's written permission, reproduction is permissible only if reproduction is without alteration/omission.
- Though TOSHIBA works continually to improve Product's quality and reliability, Product can malfunction or fail. Customers are responsible for complying with safety standards and for providing adequate designs and safeguards for their hardware, software and systems which minimize risk and avoid situations in which a malfunction or failure of Product could cause loss of human life, bodily injury or damage to property, including data loss or corruption. Before customers use the Product, create designs including the Product, or incorporate the Product into their own applications, customers must also refer to and comply with (a) the latest versions of all relevant TOSHIBA information, including without limitation, this document, the specifications, the data sheets and application notes for Product and the precautions and conditions set forth in the "TOSHIBA Semiconductor Reliability Handbook" and (b) the instructions for the application with which the Product will be used with or for. Customers are solely responsible for all aspects of their own product design or applications, including but not limited to (a) determining the appropriateness of the use of this Product in such design or applications; (b) evaluating and determining the applicability of any information contained in this document, or in charts, diagrams, programs, algorithms, sample application circuits, or any other referenced documents; and (c) validating all operating parameters for such designs and applications. **TOSHIBA ASSUMES NO LIABILITY FOR CUSTOMERS' PRODUCT DESIGN OR APPLICATIONS.**
- **PRODUCT IS NEITHER INTENDED NOR WARRANTED FOR USE IN EQUIPMENTS OR SYSTEMS THAT REQUIRE EXTRAORDINARILY HIGH LEVELS OF QUALITY AND/OR RELIABILITY, AND/OR A MALFUNCTION OR FAILURE OF WHICH MAY CAUSE LOSS OF HUMAN LIFE, BODILY INJURY, SERIOUS PROPERTY DAMAGE AND/OR SERIOUS PUBLIC IMPACT ("UNINTENDED USE").** Except for specific applications as expressly stated in this document, Unintended Use includes, without limitation, equipment used in nuclear facilities, equipment used in the aerospace industry, lifesaving and/or life supporting medical equipment, equipment used for automobiles, trains, ships and other transportation, traffic signaling equipment, equipment used to control combustions or explosions, safety devices, elevators and escalators, and devices related to power plant. **IF YOU USE PRODUCT FOR UNINTENDED USE, TOSHIBA ASSUMES NO LIABILITY FOR PRODUCT.** For details, please contact your TOSHIBA sales representative or contact us via our website.
- Do not disassemble, analyze, reverse-engineer, alter, modify, translate or copy Product, whether in whole or in part.
- Product shall not be used for or incorporated into any products or systems whose manufacture, use, or sale is prohibited under any applicable laws or regulations.
- The information contained herein is presented only as guidance for Product use. No responsibility is assumed by TOSHIBA for any infringement of patents or any other intellectual property rights of third parties that may result from the use of Product. No license to any intellectual property right is granted by this document, whether express or implied, by estoppel or otherwise.
- **ABSENT A WRITTEN SIGNED AGREEMENT, EXCEPT AS PROVIDED IN THE RELEVANT TERMS AND CONDITIONS OF SALE FOR PRODUCT, AND TO THE MAXIMUM EXTENT ALLOWABLE BY LAW, TOSHIBA (1) ASSUMES NO LIABILITY WHATSOEVER, INCLUDING WITHOUT LIMITATION, INDIRECT, CONSEQUENTIAL, SPECIAL, OR INCIDENTAL DAMAGES OR LOSS, INCLUDING WITHOUT LIMITATION, LOSS OF PROFITS, LOSS OF OPPORTUNITIES, BUSINESS INTERRUPTION AND LOSS OF DATA, AND (2) DISCLAIMS ANY AND ALL EXPRESS OR IMPLIED WARRANTIES AND CONDITIONS RELATED TO SALE, USE OF PRODUCT, OR INFORMATION, INCLUDING WARRANTIES OR CONDITIONS OF MERCHANTABILITY, FITNESS FOR A PARTICULAR PURPOSE, ACCURACY OF INFORMATION, OR NONINFRINGEMENT.**
- Do not use or otherwise make available Product or related software or technology for any military purposes, including without limitation, for the design, development, use, stockpiling or manufacturing of nuclear, chemical, or biological weapons or missile technology products (mass destruction weapons). Product and related software and technology may be controlled under the applicable export laws and regulations including, without limitation, the Japanese Foreign Exchange and Foreign Trade Law and the U.S. Export Administration Regulations. Export and re-export of Product or related software or technology are strictly prohibited except in compliance with all applicable export laws and regulations.
- Product may include products subject to foreign exchange and foreign trade control laws.
- Please contact your TOSHIBA sales representative for details as to environmental matters such as the RoHS compatibility of Product. Please use Product in compliance with all applicable laws and regulations that regulate the inclusion or use of controlled substances, including without limitation, the EU RoHS Directive. **TOSHIBA ASSUMES NO LIABILITY FOR DAMAGES OR LOSSES OCCURRING AS A RESULT OF NONCOMPLIANCE WITH APPLICABLE LAWS AND REGULATIONS.**

Toshiba Electronic Devices & Storage Corporation

<https://toshiba.semicon-storage.com/>