

Inverter/Servo

Solution Proposal by Toshiba

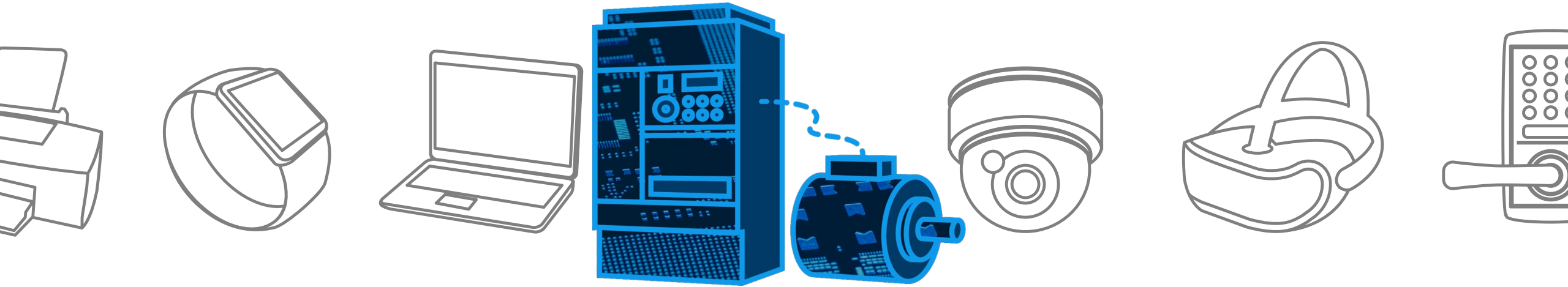

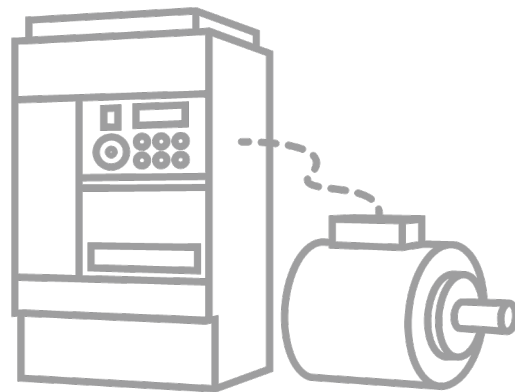
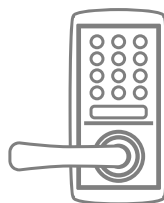

Toshiba Electronic Devices & Storage Corporation provides comprehensive device solutions to customers developing new products by applying its thorough understanding of the systems acquired through the analysis of basic product designs.



Block Diagram

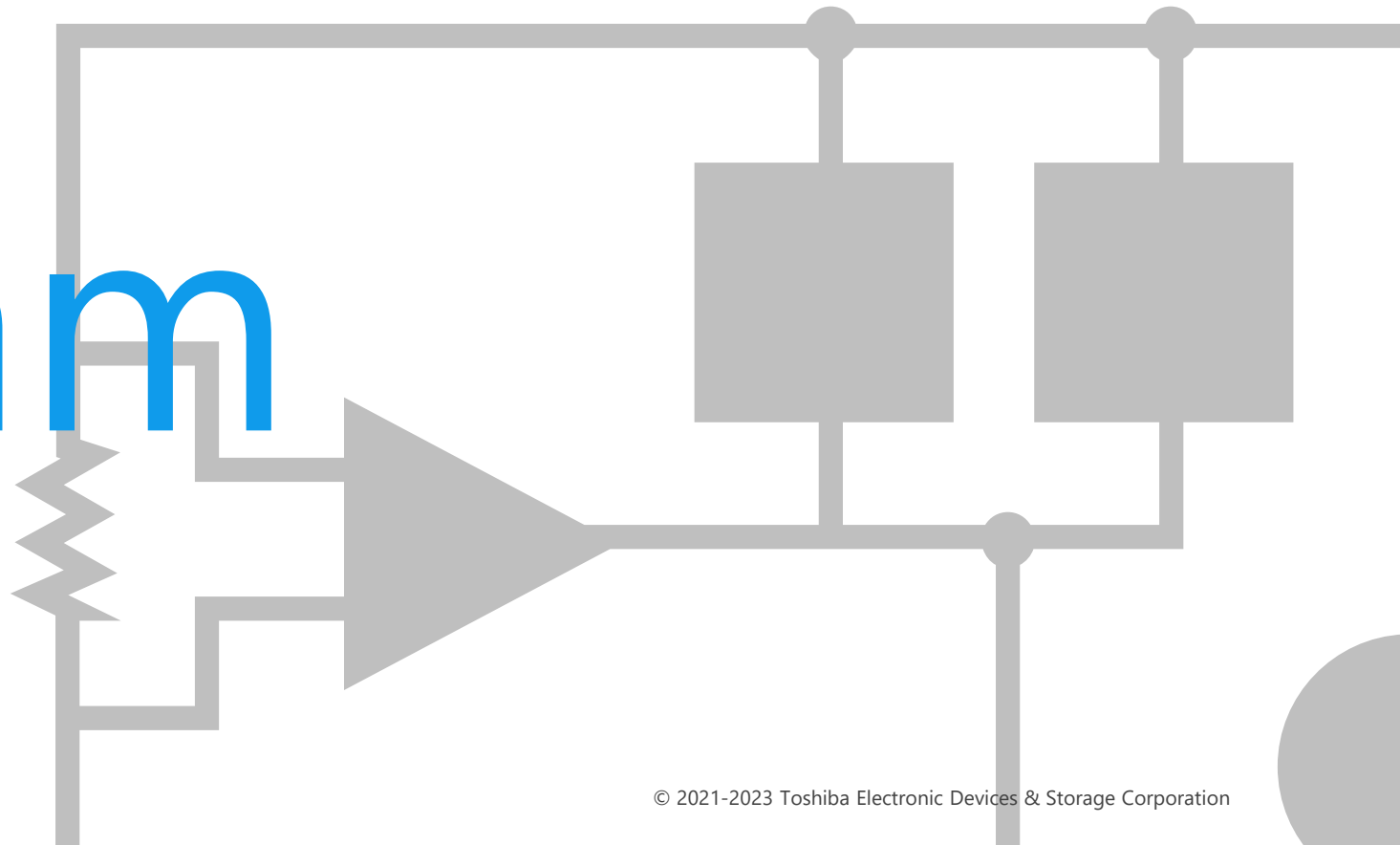

Inverter/Servo Overall block diagram

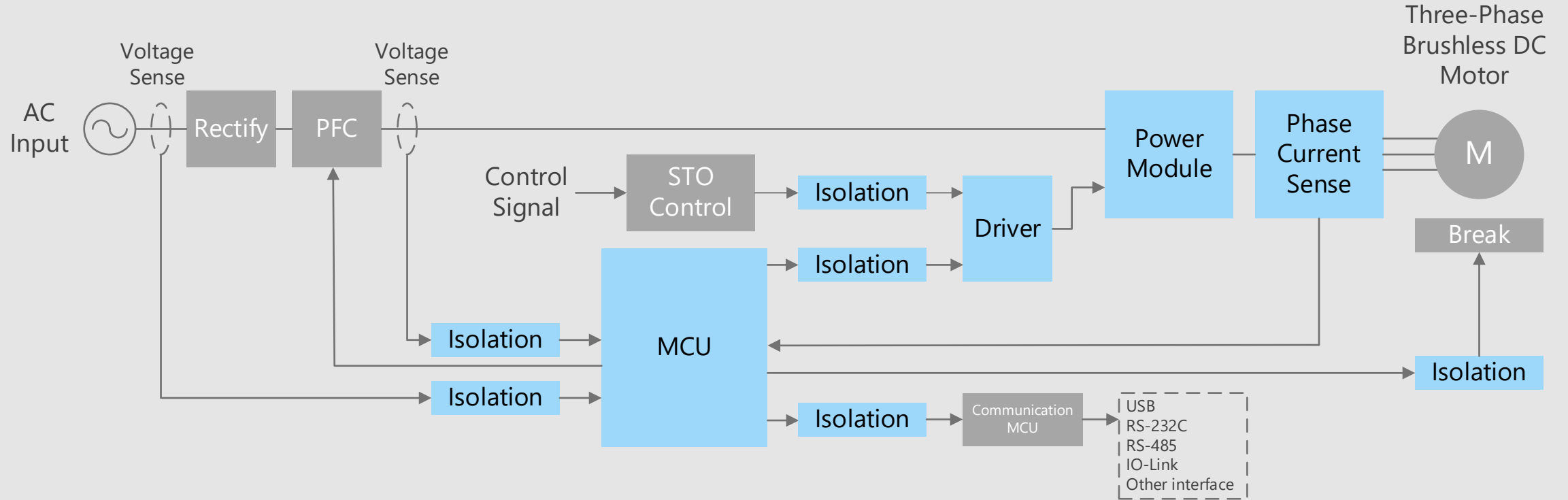

Improvement of power factor (PFC)

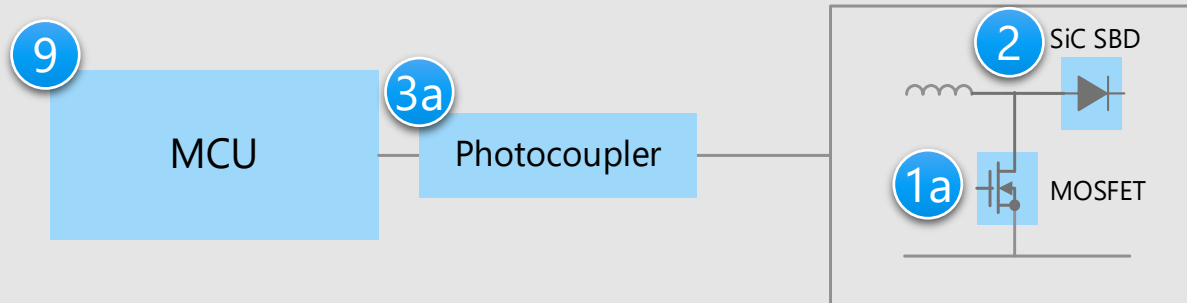

SBD: Schottky Barrier Diode

DC-DC converter

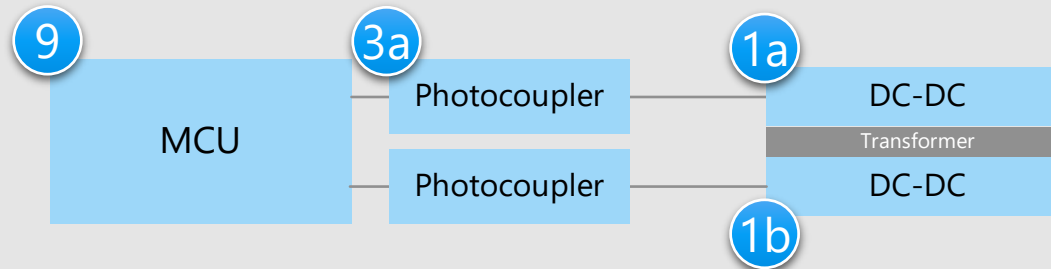

Criteria for device selection

- A high voltage MOSFET with high speed recovery diodes is suitable for PFCs and DC-DC converters.
- SiC type Schottky barrier diodes are suitable for PFC circuits.
- Both high voltage MOSFET and low voltage MOSFET are used for DC-DC converters.

Proposal from Toshiba

- **Suitable for high efficiency power supply switching** 1a
DTMOS Series MOSFET 1b
U-MOS Series MOSFET
- **Small $V_F \times Q_C$ and high surge current capability** 2
SiC Schottky barrier diode
- **Photocoupler that is resistant to noise and can operate at high temperature** 3a
Gate driver photocoupler (for MOSFET/IPM driving)
- **Easy software development using general purpose CPU cores** 9
MCU M370 Group

* Click on the numbers in the circuit diagram to jump to the detailed descriptions page

Motor driving circuit (with IGBT Module/IPM)

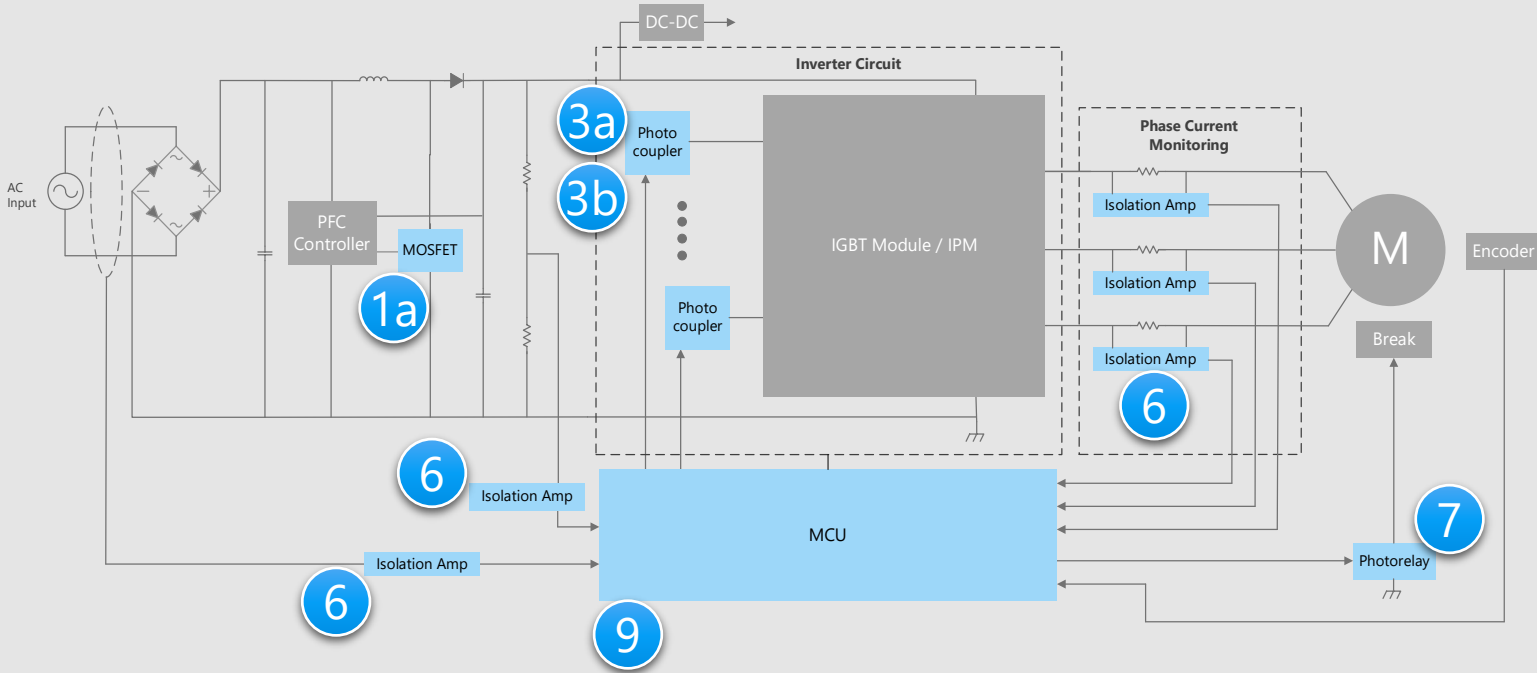

Criteria for device selection

- The use of photocouplers and photorelays realizes the signal transmission between the systems with different voltage levels, and suppress the noise influences.
- The use of photorelays instead of mechanical relays eliminates the life limitation caused by contact wear and welding at the contact points, enabling long life and quieter operation.

Proposal from Toshiba

- **Suitable for high efficiency power supply switching**
DTMOS Series MOSFET 1a
- **Photocouplers that are resistant to noise and can operate at high temperature**
Gate driver photocoupler (for MOSFET/IPM driving) 3a
Gate driver photocoupler (for IGBT driving) 3b
- **Isolation amplifiers suitable for current and voltage detection circuits**
Isolation amplifier 6
- **Photorelays suitable for replacing mechanical relays**
Photorelay 7
- **Easy software development using general purpose CPU cores**
MCU M370 Group 9

* Click on the numbers in the circuit diagram to jump to the detailed descriptions page

Multi-level motor driving circuit (with MOSFETs)

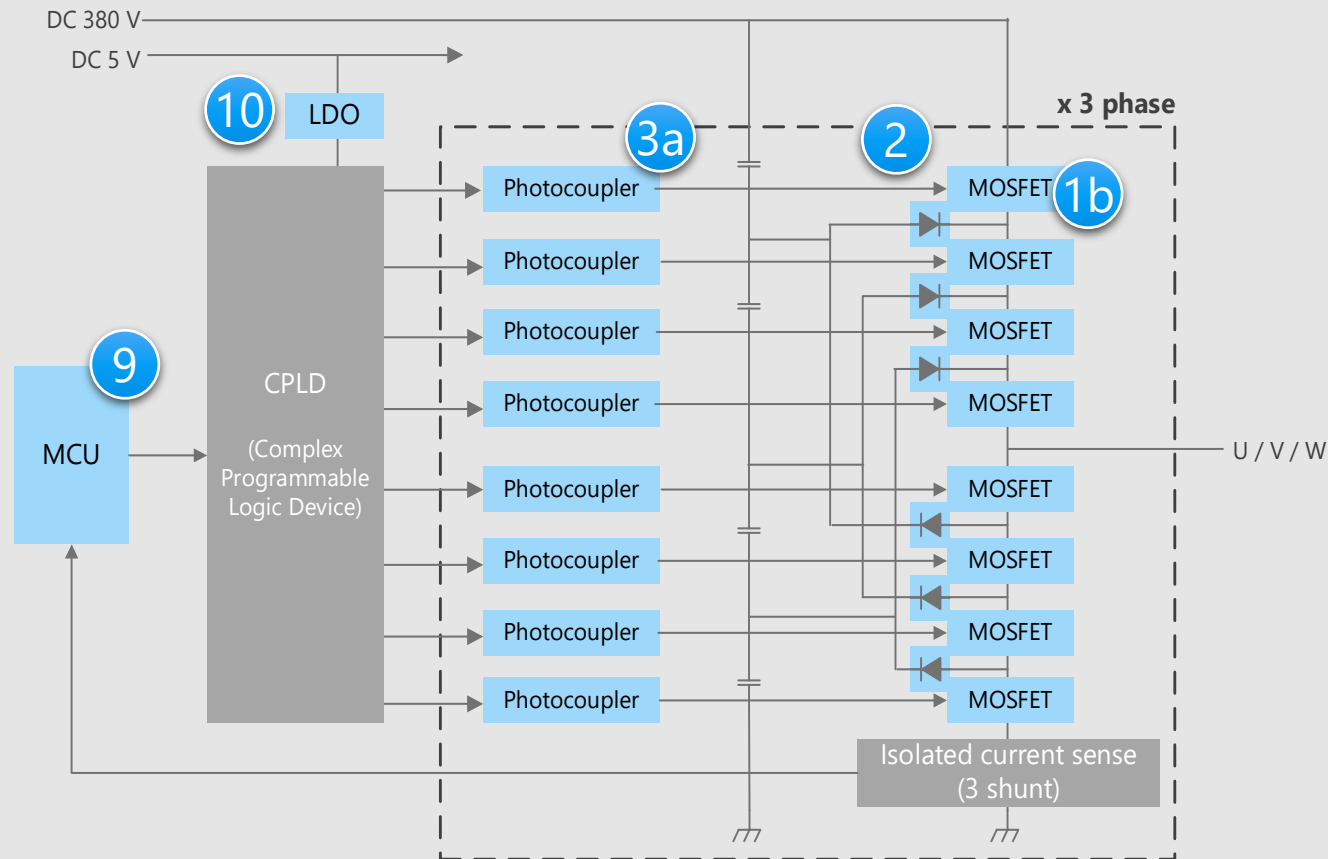

Criteria for device selection

- In a multi-level motor driving circuit, switching devices with low voltage and low on-resistance can be used, enabling efficient power conversion.
- The use of photocouplers and photorelays realizes the signal transmission between the systems with different voltage levels, and suppress the noise influences.

Proposals from Toshiba

- **Suitable for high efficiency power supply switching**
U-MOS Series MOSFET
- **Small $V_F \times Q_C$ and high surge current capability**
SiC Schottky barrier diode
- **Photocoupler that is resistant to noise and can operate at high temperature**
Gate driver photocoupler (for MOSFET/IPM driving)
- **Easy software development using general purpose CPU cores**
MCU M370 Group
- **Supply the power with low noise**
Small surface mount LDO regulator

1b

2

3a

9

10

* Click on the numbers in the circuit diagram to jump to the detailed descriptions page

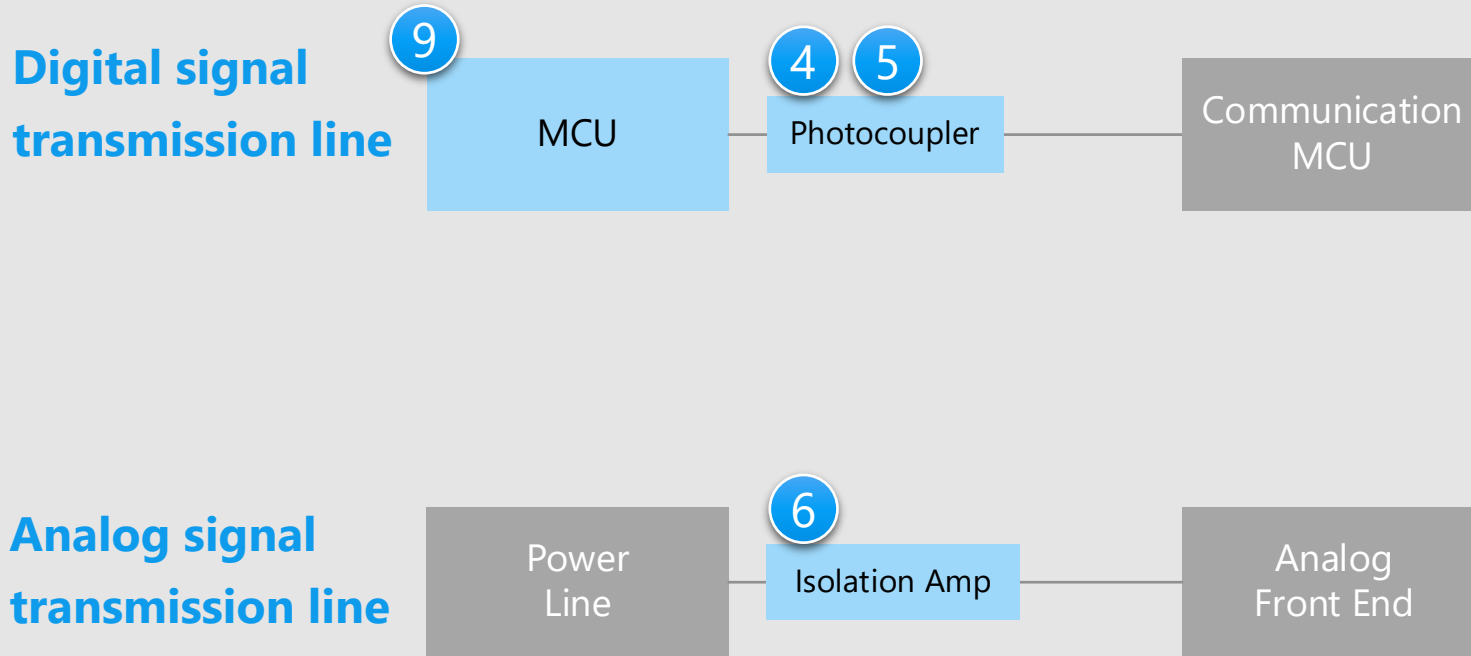

Criteria for device selection

- Photocouplers are suitable for isolation in digital signal transmission lines.
- Isolation amplifiers are suitable for isolation between the high voltage circuit and various detection circuits.

Proposal from Toshiba

- **Photocouplers that are resistant to noise and can operate at high temperature** (4)
Photocoupler for high speed communication
Transistor output photocoupler (5)
- **Isolation amplifiers suitable for current and voltage detection circuits** (6)
Isolation amplifier
- **Easy software development using general purpose CPU cores** (9)
MCU M370 Group

* Click on the numbers in the circuit diagram to jump to the detailed descriptions page

Interface circuits

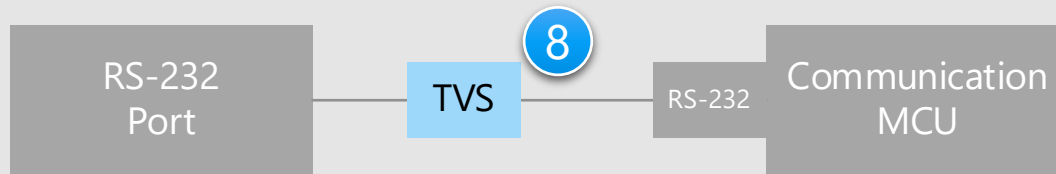
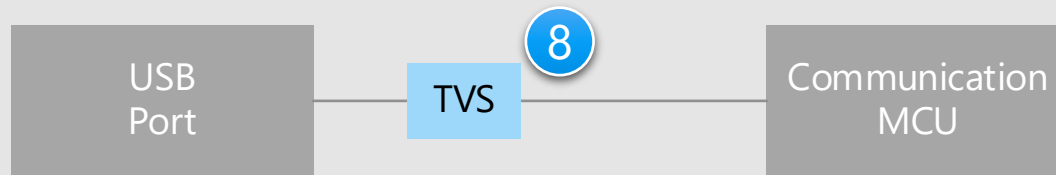

Criteria for device selection

- TVS diode with a low capacitance is suitable for ESD protecting the USB signal line.

Proposal from Toshiba

- **Prevent circuit malfunctions and protect devices by absorbing electrostatic discharge from external terminals**

TVS diode

8

* Click on the numbers in the circuit diagram to jump to the detailed descriptions page

Recommended Devices

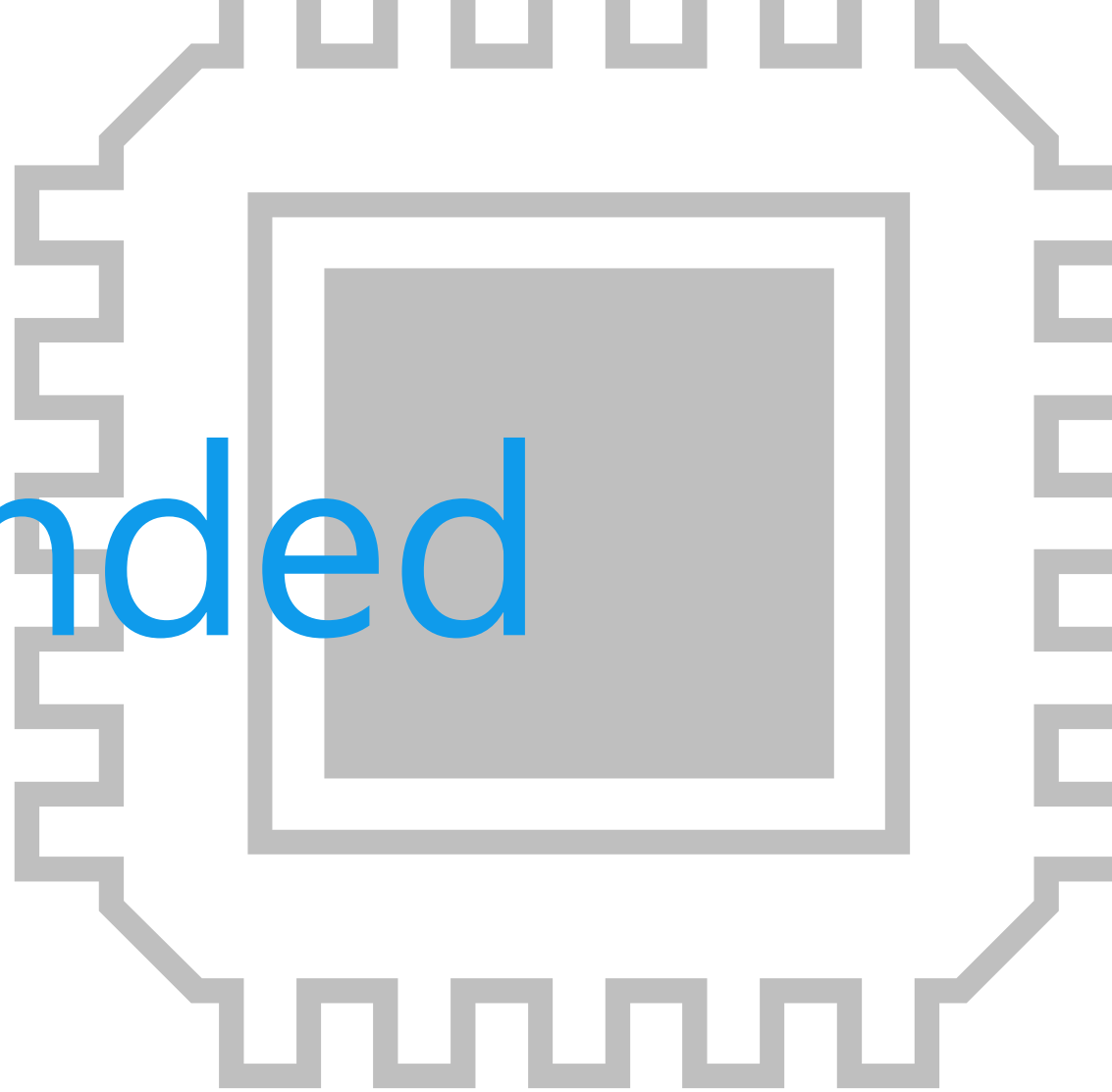

Device solutions to address customer needs

As described above, in the design of inverter/servo system, "**Miniaturization of circuit boards**", "**Low power consumption of sets**" and "**Robust operation**" are important factors. Toshiba's proposals are based on these three solution perspectives.

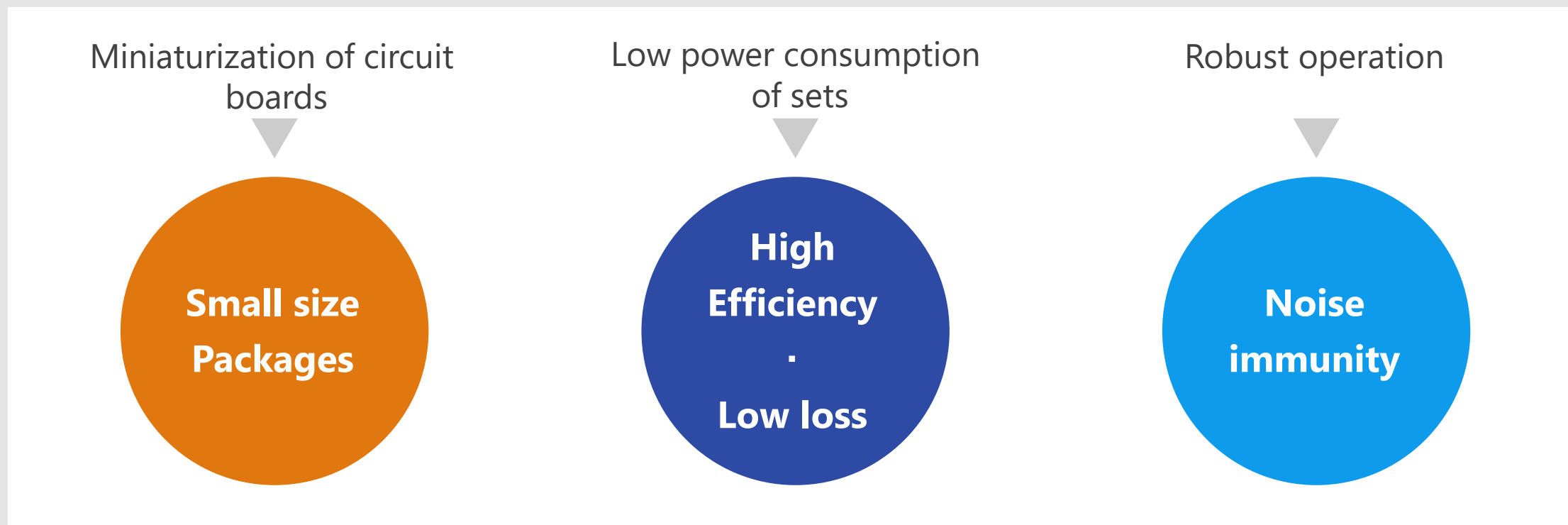

Device solutions to address customer needs

Small size packages

High Efficiency
·
Low loss

Noise immunity

1a	DTMOS Series MOSFET	●	●	●
1b	U-MOS Series MOSFET	●	●	●
2	SiC Schottky barrier diode	●	●	●
3a	Gate driver photocoupler (for MOSFET/IPM driving)	●	●	●
3b	Gate driver photocoupler (for IGBT driving)	●	●	●
4	Photocoupler for high speed communication	●	●	●
5	Transistor output photocoupler	●	●	●
6	Isolation amplifier	●	●	●
7	Photorelay	●	●	●

Device solutions to address customer needs

Small size packages

High Efficiency
-
Low loss

Noise immunity

8	TVS diode	●		●
9	MCU M370 Group	●	●	
10	Small surface mount LDO regulator	●	●	●

Value provided

DTMOS series contribute to provide highly efficient power supply by improving $R_{DS(on)} \times Q_{gd}$.

1 $R_{DS(ON)} \times Q_{gd}$ improvement

In the DTMOSVI series, the $R_{DS(ON)} \times Q_{gd}$ is reduced by approximately 40 % compared with Toshiba's conventional DTMOSIV-H series product by optimizing the gate structure design and processes. (Based on Toshiba's measurement data as of March, 2023)

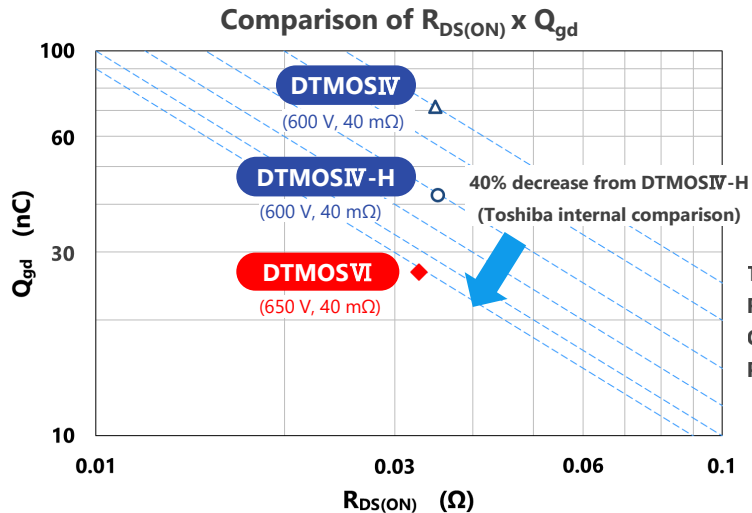



Test Condition
 $R_{DS(ON)}$: I_D = 28.5 A, V_{GS} = 10 V
 Q_{gd} : V_{DD} = 400 V, I_D = 57 A, V_{GS} = 10 V
 Plots the mean of the measured values.
 (Based on Toshiba's measurement data as of March, 2023)

2 Body diode reverse recovery characteristics

High speed body diode reduces recovery loss and contributes to higher efficiency of power supply. (TK16A60W5)

Lineup

Part number	TK25A60X	TK16A60W5	TK110A65Z	TK190A65Z	TK110U65Z	TK190U65Z
Package	TO-220SIS 			TOLL 		
V _{DSS} [V]	600	600	650	650	650	650
I _D [A]	25	15.8	24	15	24	15
$R_{DS(ON)}$ [Ω] @V _{GS} = 10 V	Typ.	0.105	0.18	0.092	0.158	0.086
	Max	0.125	0.23	0.11	0.19	0.11
Polarity	N-ch	N-ch	N-ch	N-ch	N-ch	N-ch
Generation	DTMOSIV-H	DTMOSIV(HSD)	DTMOSVI	DTMOSVI	DTMOSVI	DTMOSVI

[Return to Block Diagram TOP](#)

Value provided

Contribution to energy saving and efficiency increasing with wide variety of lineup and easy design.

1 High efficiency

Low on-resistance ($R_{DS(ON)}$) achieved by fine integration process.
Trade off between $R_{DS(ON)}$ and Q_{gr} , Q_{sw} , Q_{oss} have been improved by optimization of cell structure.

2 Wide variety of lineup

Voltage from 20 to 250 V are lined up.
Wide variety of packages from SMD to lead type are provided.



3 Easy to design

Low V_{DS} spike and ringing have been realized by parasitic snubber.
High avalanche capability.



Wide variety of packages

Lineup

Part number	TPN19008QM	TPH2R408QM	TPH4R008QM	TPH9R00CQ5
Package	TSON Advance 	SOP Advance 	SOP Advance(N) 	SOP Advance / SOP Advance(N)
V_{DSS} [V]	80	80	80	150
I_D [A]	34 (38*)	120 (200*)	86 (140*)	64 (108*)
$R_{DS(ON)}$ [Ω] @ $V_{GS} = 10$ V	Typ.	0.0147	0.0019	0.0031
	Max	0.019	0.00243	0.004
Polarity	N-ch	N-ch	N-ch	N-ch
Generation	U-MOSX-H	U-MOSX-H	U-MOSX-H	U-MOSX-H

*: Silicon limit

[Return to Block Diagram TOP](#)

Value provided

Contribution to energy saving and efficiency increasing with wide variety of lineup and easy design.

1 High efficiency

Low on-resistance ($R_{DS(ON)}$) achieved by fine integration process.
Trade off between $R_{DS(ON)}$ and Q_{gr} , Q_{swr} , Q_{oss} have been improved by optimization of cell structure.

2 Wide variety of lineup

Voltage from 20 to 250 V are lined up.
Wide variety of packages from SMD to lead type are provided.

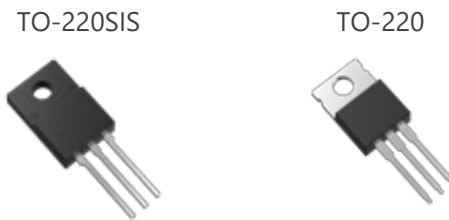

3 Easy to design

Low V_{DS} spike and ringing have been realized by parasitic snubber.
High avalanche capability.



Wide variety of packages

Lineup

Part number	TK2R4A08QM	TK2R4E08QM	TK100E10N1
Package	TO-220SIS 	TO-220 	
V_{DSS} [V]	80	80	100
I_D [A]	100 (116*)	120 (290*)	100 (207*)
$R_{DS(ON)}$ [Ω] @ $V_{GS} = 10$ V	Typ.	0.00188	0.00197
	Max	0.00244	0.00244
Polarity	N-ch	N-ch	N-ch
Generation	U-MOSX-H	U-MOSX-H	U-MOSVIII-H

*: Silicon limit

[◆Return to Block Diagram TOP](#)

Value provided

Can be applied to power factor correction circuits and a wide range of power supply control applications, and contributes to miniaturization of set.

1 High surge current tolerance

The non-repetitive peak forward surge current $I_{FSM} = 97$ A (Max) (TRS12E65F). Surge current is increased around 2 times by using improved JBS (Junction Barrier controlled Schottky) structure incorporating the concept of the Merged PiN Schottky (MPS) structure. (Comparison with Toshiba's first generation products)

2 Second generation chip design

The figure of merit ($V_F \times Q_C$) [Note] is improved by 30 % and the non-repetitive peak forward surge current (I_{FSM}) is improved, thereby contributing to higher efficiency of the power supply. (Comparison with Toshiba's first generation products)

3 High heat radiation package



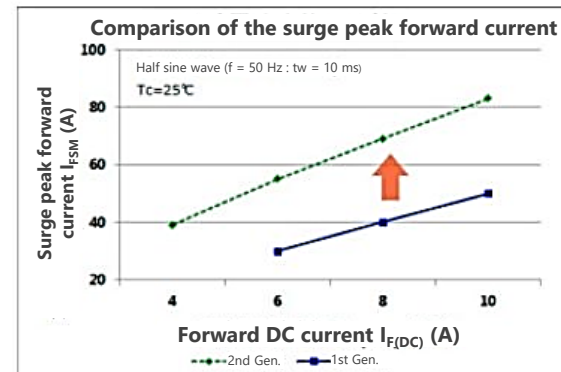
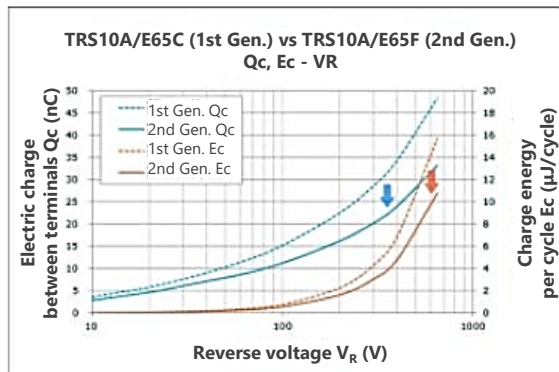

Provided in TO-220 and TO-247 through hole type packages.

[Note] The $V_F \times Q_C$ (product of forward voltage and total charge) is an index representing the loss performance of the SiC SBD. When comparing the products with the same current rating, the smaller the index, the lower the loss.

Comparison between Toshiba's the first and second generations products



Lineup

Part number	TRS4A65F	TRS4E65F	TRS12E65F	TRS12N65FB	TRS16N65FB	TRS20N65FB	TRS24N65FB
Package	 TO-220F-2L	 TO-220-2L	 TO-220-2L	 TO-247 (Center tap)			
V_{RRM} [V]	650	650	650	650	650	650	650
$I_{F(DC)}$ [A]	4	4	12	6 / 12 *	8 / 16 *	10 / 20 *	12 / 24 *
I_{FSM} [A]	37	39	97	52 / 104 *	65 / 130 *	79 / 158 *	92 / 184 *
V_F (Typ.) [V]	1.45 @ $I_F = 4$ A	1.45 @ $I_F = 4$ A	1.45 @ $I_F = 12$ A	1.45 @ $I_F = 6$ A	1.45 @ $I_F = 8$ A	1.45 @ $I_F = 10$ A	1.45 @ $I_F = 12$ A

* Per Leg / Both Legs

[Return to Block Diagram TOP](#)

[Note 1] IPM : Intelligent Power Module

Value provided

Combines an infrared light emitting diode with high optical output and a light receiving IC chip with high gain and high speed.

1 High noise immunity

The products have internal faraday shield that provides high CMTI (Common Mode Transient Immunity).

2 High isolation voltage

The isolation voltage BV_S is 5000 [Vrms].
[Note 2] $BV_S = 3750$ [Vrms] for TLP152.

3 High temperature operation

The products are designed to operate even under severe ambient temperature conditions, such as inverters, robots and machinery, etc.

Internal circuit configuration
(TLP5774H)

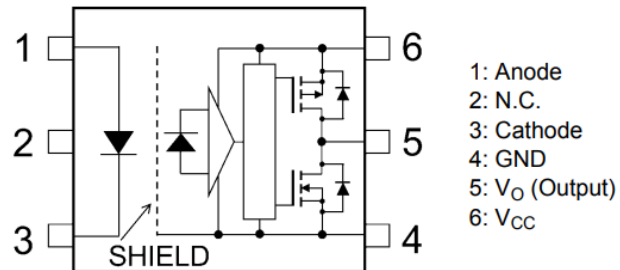

UL-recognized UL1577, File No.E67349



cUL-recognized CSA Component Acceptance Service No.5A File No.E67349

VDE-recognized EN60747-5-5, EN62368-1 [Note 3]

CQC-recognized GB4943.1, GB8898

[Note 3] When a VDE approved type is needed, please designate the Option (D4).

Lineup

Part number	TLP152	TLP5774H	TLP2745	TLP2719
Package	5pin SO6 	SO6L 		
Application	MOSFET driving		IPM driving	
CMTI (Min) [kV/ μ s]	± 20	± 35	± 30	± 10
T_{opr} [$^{\circ}$ C]	-40 to 100	-40 to 125	-40 to 110	-40 to 100
Propagation delay time (Max) [ns]	190	150	120	2000
Overcurrent protection	-	-	-	-

[Return to Block Diagram TOP](#)

Value provided

High isolation by opto-coupling solution and characteristics suitable for gate driving help to simplify circuit design.

1 High noise immunity

The products have internal faraday shield that provides high CMTI (Common Mode Transient Immunity).

2 High temperature operation

The products are designed to operate even under severe ambient temperature conditions, such as inverters, robots and machinery, etc.

3 Wide output current ratings lineup

Wide product lineup suitable for both gate drive and pre gate drive enables to choose product suitable for each driving.

Internal circuit configuration (TLP5212)

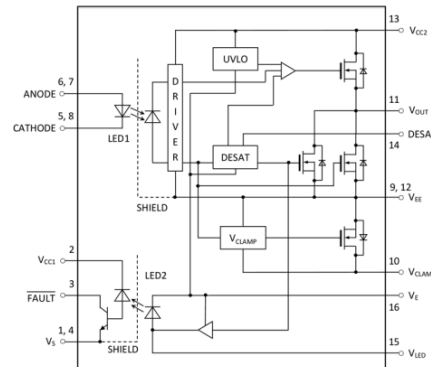

UL-recognized UL1577, File No.E67349

cUL-recognized CSA Component Acceptance Service No.5A File No.E67349

VDE-recognized EN60747-5-5, EN62368-1 [Note]

CQC-recognized GB4943.1, GB8898

[Note] When a VDE approved type is needed, please designate the Option (D4).

Lineup

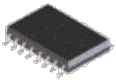
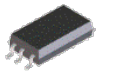
Part number	TLP5214A	TLP5212	TLP5222	TLP5231	TLP5754H	TLP5705H
Package	SO16L 				SO6L 	
CMTI (Min) [kV/μs]	±35	±25		±35	±50	
T _{opr} [°C]	-40 to 110				-40 to 125	
Peak output current [A]	±4.0	±2.5		±4.0	±5.0	
Overcurrent protection	✓				-	

[◆Return to Block Diagram TOP](#)

Value provided

Combines an infrared light emitting diode with high optical output and a light receiving IC chip with high gain and high speed.

1 High noise immunity

The products have internal faraday shield that provides high CMTI (Common Mode Transient Immunity).

2 High isolation voltage

The isolation voltage BV_S is 5000 [Vrms].

3 High temperature operation

The products are designed to operate even under severe ambient temperature conditions, such as inverters, robots and machinery, etc.

Internal circuit configuration (TLP2210)

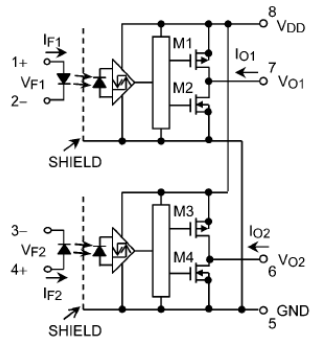

- 1: Anode 1
- 2: Cathode 1
- 3: Cathode 2
- 4: Anode 2
- 5: GND
- 6: VO 2 (output 2)
- 7: VO 1 (output 1)
- 8: VDD

UL-recognized UL1577, File No.E67349
 cUL-recognized CSA Component Acceptance Service No.5A File No.E67349
 VDE-recognized EN60747-5-5, EN62368-1 [Note]
 CQC-recognized GB4943.1, GB8898
 [Note] When a VDE approved type is needed, please designate the Option (D4).

Lineup

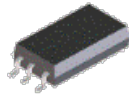
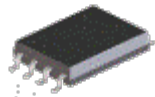
Part number	TLP2710	TLP2761	TLP2770	TLP2210	TLP2261	TLP2270
Package	SO6L 			SO8L(LF4) 		
Channel	1			2		
Data rate [Mbps]	5	15	20	5	15	20
T _{opr} [°C]	-40 to 125	-40 to 125	-40 to 125	-40 to 125	-40 to 125	-40 to 125

[Return to Block Diagram TOP](#)

5 Transistor output photocoupler

TLP383 / TLP293 / TLP385

Small size packages

High efficiency
Low loss

Noise immunity

Value provided

High CTR (Current Transfer Ratio) is realized even in low input current range ($I_F = 0.5 \text{ mA}$).

1 High current transfer ratio

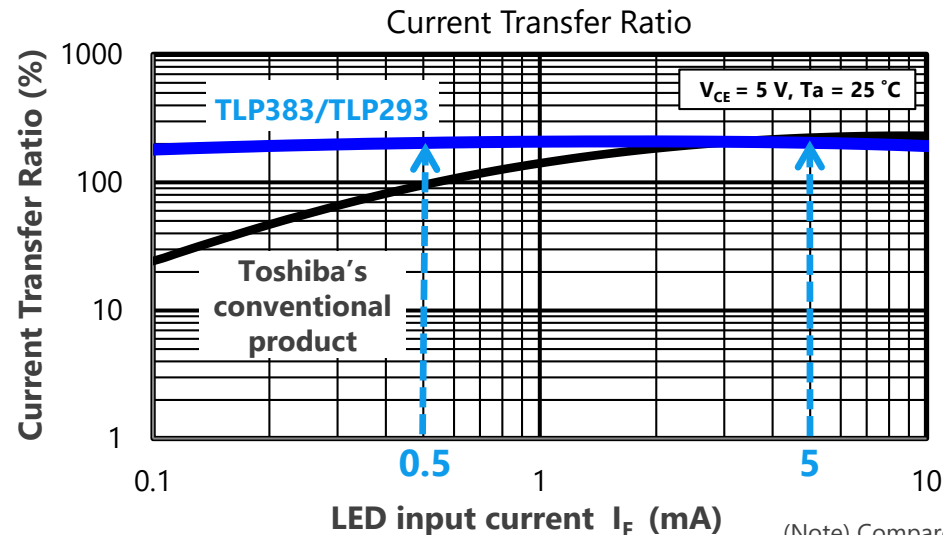

The TLP383 and TLP293 are high isolation photocouplers that optically couple a phototransistor and high output infrared LED. Compared to Toshiba's conventional products (TLP385), higher CTR (Current Transfer Ratio) in low input current range (@ $I_F = 0.5 \text{ mA}$) is realized.



(Note) Compared with Toshiba conventional products

2 High temperature operation

The products are designed to operate even under severe ambient temperature conditions, such as inverters, robots and machinery, etc.

Lineup			
Part number	TLP383	TLP293	TLP385
Package	4pin SO6L 	SO4 	4pin SO6L 
BV_S [Vrms]	5000	3750	5000
T_{opr} [$^\circ\text{C}$]	-55 to 125	-55 to 125	-55 to 110

[Return to Block Diagram TOP](#)

Value provided

This is an isolation amplifier suitable for current and voltage detection of motors and inverters.

1 High isolation performance

This optical coupling type isolation amplifier has a high-precision $\Delta\Sigma$ AD conversion circuit on the input side and a high precision DA conversion circuit on the output side.

2 Support for common mode

Common-mode transient immunity is provided with CMTI [Note 1] = 15 kV/ μ s (Min).
[Note 1] CMTI : Common Mode Transient Immunity

3 5 V system power supply voltages

Input power supply voltage
 V_{DD1} = 4.5 to 5.5 V
Output power supply voltage
 V_{DD2} = 3.0 to 5.5 V

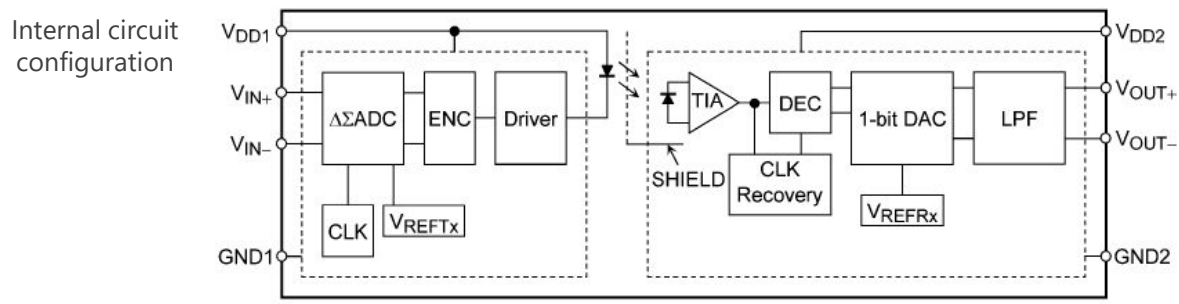

Note: A 0.1- μ F bypass capacitor must be connected between 1 and 4 pins and between 5 and 8 pins.

UL-approved: UL1577, File No.E67349
cUL-approved: CSA Component Acceptance Service No.5A File No.E67349
VDE-approved: EN 60747-5-5, EN 62368-1 [Note 2]

[Note 2] When a VDE approved type is needed, please designate the Option (D4).

Lineup	
Part number	TLP7820
Package	SO8L(LF4) 
BV _S [Vrms]	5000
T _{opr} [°C]	-40 to 105
CMTI (Min) [kV/ μ s]	15

[Return to Block Diagram TOP](#)

Value provided

Photorelay consists of an infrared light emitting diode optically coupled to a photo-MOSFET and is suitable for replacing mechanical relays.

1 Low on-resistance

On-resistance $R_{ON} = 0.05 \Omega$ (Typ.)
(TLP3547: A connection) [Note 1]

2 Wide current range

Wide range of allowed ON current I_{ON} ,
suitable for power line control.
 $I_{ON} = 5.0 \text{ A}$ (Max)
(TLP3547: A connection) [Note 1]

3 Lineup of package and isolation voltage

The lineup of isolation voltage and package for freedom of design are provided.

TLP3545A
Internal equivalent circuit

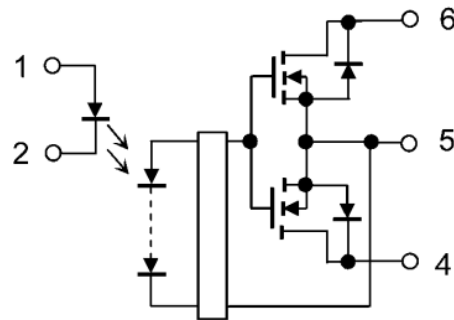

[Note 1] Please refer to the technical data sheet for connection.

Safety Standards

UL approved: UL1577, File No.E67349

cUL approved: CSA Component Acceptance Service No. 5A, File No.E67349





UL-recognized: UL 508, File No.E499232 [Note 2]

VDE-approved: EN 60747-5-5 [Note 3]

[Note 2] Please refer Absolute Maximum Ratings (UL-recognized UL 508) for UL 508 products.

[Note 3] When a VDE approved type is needed, please designate the Option (D4).

Lineup

Part number	TLP3122A	TLP170AM	TLP3545A	TLP3547	TLP240A	TLP241B
Package	4pin SO6 		DIP6 	DIP8 	DIP4 	
I_{ON} [A]	1.4	0.7	4.0	5.0	0.5	2.0
V_{OFF} [V]	60	60	60	60	60	100
R_{ON} (Max) [Ω]	0.25	0.3	0.06	0.05	2.0	0.2
BV_S [Vrms]	3750	3750	2500	2500	5000	5000

[Return to Block Diagram TOP](#)

Value provided

Absorbs static electricity from external terminals, prevents circuit malfunction and protects devices.

1 High ESD pulse absorption performance

Improved ESD absorption compared to our conventional products. (50 % reduction in operating resistance) For some products, both low operating resistance and low capacitance are realized and ensures high signal protection performance and signal quality.

2 Suppress ESD energy by low clamp voltage

Protect the connected circuits/devices using proprietary technology.

3 Suitable for high density mounting

A variety of small packages are available.

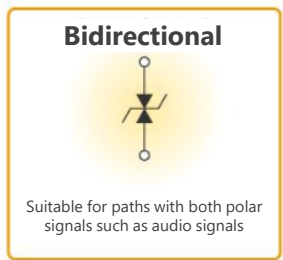
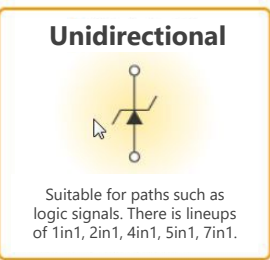
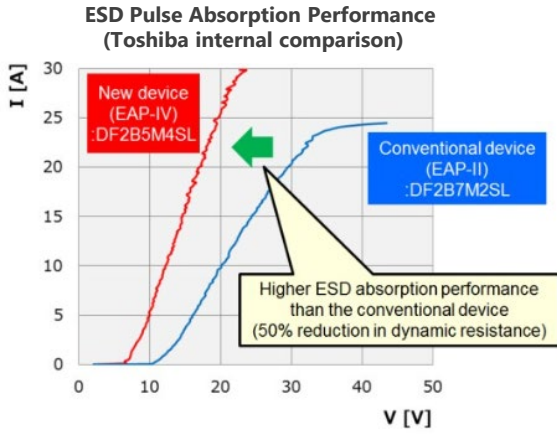

Lineup

Part number	DF2B6M4BSL	DF2B20M4SL	DF2B5PCT	DF2B7PCT	DFS2S14P2CTC
Package	SL2		CST2		CST2C
V_{ESD} [kV]	±8	±15	±30	±30	±30
V_{RWM} (Max) [V]	5.5	18.5	3.6	5.5	12.6
C_t (Typ.) [pF]	0.12	0.2	41	45	270
R_{DYN} (Typ.) [Ω]	1.05	0.2	0.1	0.1	0.08
Purpose	Signal line protection		Power line protection		

(Note) This product is an ESD protection diode and cannot be used for purposes other than ESD protection.

[Return to Block Diagram TOP](#)

Value provided

Based on the global standard Arm[®] Cortex[®]-M3 core, it provides high performance and a full set of basic functions

1 Motor controller logic circuit

Three-phase brushless motor controller, execute PWM output for square wave drive and sine wave drive.

2 Built-in vector engine

Vector engine that supports vector control, control the motor more smoothly and efficiency with a low CPU load.

3 Analog circuit for motor control

AD converters with high speed and high accuracy allow conversion timing and PWM output to be linked.

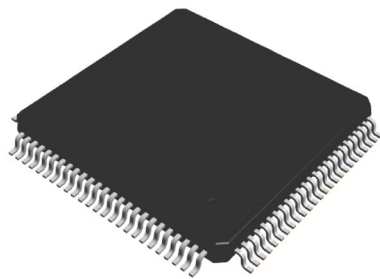

LQFP100 Package
14 x 14 mm

Lineup

Part number	Flash ROM	RAM	Package
TMPM370FYFG	256 KB	10 KB	LQFP100-P-1414-0.50H
TMPM372FWUG	128 KB	6 KB	LQFP64-P-1010-0.50E
TMPM373FWDUG	128 KB	6 KB	LQFP48-P-0707-0.50C
TMPM374FWUG	128 KB	6 KB	LQFP44-P-1010-0.80B
TMPM375FSDMG	64 KB	4 KB	SSOP30-P-300-0.65
TMPM376DFDG	512 KB	32 KB	LQFP100-P-1414-0.50H
TMPM37AFSQG	64 KB	4 KB	P-VQFN32-0505-0.50-003

[◆Return to Block Diagram TOP](#)

10 Small surface mount LDO regulator

TCR15AG / TCR13AG / TCR8BM / TCR5BM / TCR5RG / TCR3RM / TCR3U / TCR2L / TAR5 Series

Small size packages

High efficiency
Low loss

Noise immunity

Value provided

Wide lineup from general purpose type to small package type are provided.
Contribute to realize a stable power supply not affected by fluctuation of battery.

1 Low dropout voltage

The originally developed latest process significantly improved the dropout voltage characteristics.

2 High PSRR Low output noise voltage

Many product series that realize both high PSRR (Power Supply Rejection Ratio) and low output noise voltage characteristics are provided. They are suitable for stable power supply for analog circuit.

3 Low current consumption

0.34 μA of $I_{B(ON)}$ is realized by utilizing CMOS process and unique circuit technology.
(TCR3U Series)

Low dropout voltage

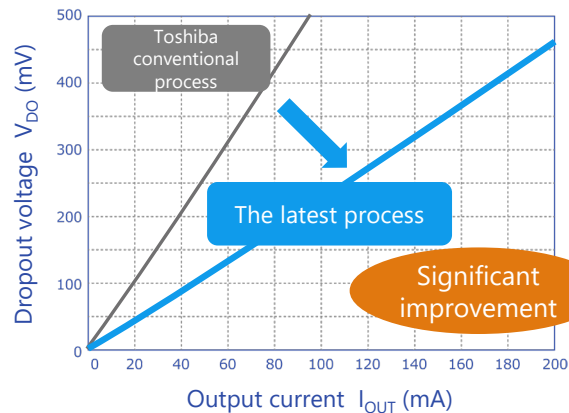

(Note) Toshiba internal comparison

Rich package lineup

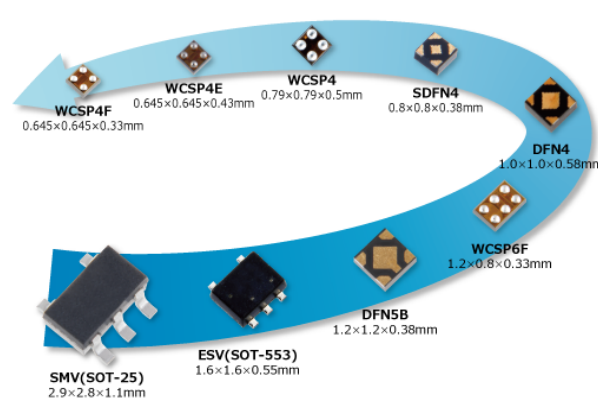

Lineup

Part number	TCR15AG Series	TCR13AG Series	TCR8BM Series	TCR5BM Series	TCR5RG Series	TCR3RM Series	TCR3U Series	TCR2L Series	TAR5 Series
Features	Low dropout voltage High PSRR				High PSRR Low noise Low current consumption		Low current consumption		15 V Input voltage Bipolar type
I_{OUT} (Max) [A]	1.5	1.3	0.8	0.5		0.3		0.2	
PSRR (Typ.) [dB] @f = 1 kHz	95	90	98	98	100	100	70	-	70
I_B (Typ.) [μA]	25	56	20	19	7	7	0.34	1	170

[Return to Block Diagram TOP](#)

If you are interested in these products and have questions or comments about any of them, please do not hesitate to contact us below:

Contact address: <https://toshiba.semicon-storage.com/ap-en/contact.html>



Terms of use

This terms of use is made between Toshiba Electronic Devices and Storage Corporation ("We") and customers who use documents and data that are consulted to design electronics applications on which our semiconductor devices are mounted ("this Reference Design"). Customers shall comply with this terms of use. Please note that it is assumed that customers agree to any and all this terms of use if customers download this Reference Design. We may, at its sole and exclusive discretion, change, alter, modify, add, and/or remove any part of this terms of use at any time without any prior notice. We may terminate this terms of use at any time and for any reason. Upon termination of this terms of use, customers shall destroy this Reference Design. In the event of any breach thereof by customers, customers shall destroy this Reference Design, and furnish us a written confirmation to prove such destruction.

1. Restrictions on usage

- 1.This Reference Design is provided solely as reference data for designing electronics applications. Customers shall not use this Reference Design for any other purpose, including without limitation, verification of reliability.
- 2.This Reference Design is for customer's own use and not for sale, lease or other transfer.
- 3.Customers shall not use this Reference Design for evaluation in high or low temperature, high humidity, or high electromagnetic environments.
- 4.This Reference Design shall not be used for or incorporated into any products or systems whose manufacture, use, or sale is prohibited under any applicable laws or regulations.

2. Limitations

- 1.We reserve the right to make changes to this Reference Design without notice.
- 2.This Reference Design should be treated as a reference only. We are not responsible for any incorrect or incomplete data and information.
- 3.Semiconductor devices can malfunction or fail. When designing electronics applications by referring to this Reference Design, customers are responsible for complying with safety standards and for providing adequate designs and safeguards for their hardware, software and systems which minimize risk and avoid situations in which a malfunction or failure of semiconductor devices could cause loss of human life, bodily injury or damage to property, including data loss or corruption. Customers must also refer to and comply with the latest versions of all relevant our information, including without limitation, specifications, data sheets and application notes for semiconductor devices, as well as the precautions and conditions set forth in the "Semiconductor Reliability Handbook".
- 4.When designing electronics applications by referring to this Reference Design, customers must evaluate the whole system adequately. Customers are solely responsible for all aspects of their own product design or applications. WE ASSUME NO LIABILITY FOR CUSTOMERS' PRODUCT DESIGN OR APPLICATIONS.
- 5.No responsibility is assumed by us for any infringement of patents or any other intellectual property rights of third parties that may result from the use of this Reference Design. No license to any intellectual property right is granted by this terms of use, whether express or implied, by estoppel or otherwise.
- 6.THIS REFERENCE DESIGN IS PROVIDED "AS IS". WE (a) ASSUME NO LIABILITY WHATSOEVER, INCLUDING WITHOUT LIMITATION, INDIRECT, CONSEQUENTIAL, SPECIAL, OR INCIDENTAL DAMAGES OR LOSS, INCLUDING WITHOUT LIMITATION, LOSS OF PROFITS, LOSS OF OPPORTUNITIES, BUSINESS INTERRUPTION AND LOSS OF DATA, AND (b) DISCLAIM ANY AND ALL EXPRESS OR IMPLIED WARRANTIES AND CONDITIONS RELATED TO THIS REFERENCE DESIGN, INCLUDING WARRANTIES OR CONDITIONS OF MERCHANTABILITY, FITNESS FOR A PARTICULAR PURPOSE, ACCURACY OF INFORMATION, OR NONINFRINGEMENT.

3. Export Control

Customers shall not use or otherwise make available this Reference Design for any military purposes, including without limitation, for the design, development, use, stockpiling or manufacturing of nuclear, chemical, or biological weapons or missile technology products (mass destruction weapons). This Reference Design may be controlled under the applicable export laws and regulations including, without limitation, the Japanese Foreign Exchange and Foreign Trade Law and the U.S. Export Administration Regulations. Export and re-export of this Reference Design are strictly prohibited except in compliance with all applicable export laws and regulations.

4. Governing Laws

This terms of use shall be governed and construed by laws of Japan.

RESTRICTIONS ON PRODUCT USE

- Toshiba Electronic Devices & Storage Corporation, and its subsidiaries and affiliates (collectively "TOSHIBA"), reserve the right to make changes to the information in this document, and related hardware, software and systems (collectively "Product") without notice.
- This document and any information herein may not be reproduced without prior written permission from TOSHIBA. Even with TOSHIBA's written permission, reproduction is permissible only if reproduction is without alteration/omission.
- Though TOSHIBA works continually to improve Product's quality and reliability, Product can malfunction or fail. Customers are responsible for complying with safety standards and for providing adequate designs and safeguards for their hardware, software and systems which minimize risk and avoid situations in which a malfunction or failure of Product could cause loss of human life, bodily injury or damage to property, including data loss or corruption. Before customers use the Product, create designs including the Product, or incorporate the Product into their own applications, customers must also refer to and comply with (a) the latest versions of all relevant TOSHIBA information, including without limitation, this document, the specifications, the data sheets and application notes for Product and the precautions and conditions set forth in the "TOSHIBA Semiconductor Reliability Handbook" and (b) the instructions for the application with which the Product will be used with or for. Customers are solely responsible for all aspects of their own product design or applications, including but not limited to (a) determining the appropriateness of the use of this Product in such design or applications; (b) evaluating and determining the applicability of any information contained in this document, or in charts, diagrams, programs, algorithms, sample application circuits, or any other referenced documents; and (c) validating all operating parameters for such designs and applications. **TOSHIBA ASSUMES NO LIABILITY FOR CUSTOMERS' PRODUCT DESIGN OR APPLICATIONS.**
- **PRODUCT IS NEITHER INTENDED NOR WARRANTED FOR USE IN EQUIPMENTS OR SYSTEMS THAT REQUIRE EXTRAORDINARILY HIGH LEVELS OF QUALITY AND/OR RELIABILITY, AND/OR A MALFUNCTION OR FAILURE OF WHICH MAY CAUSE LOSS OF HUMAN LIFE, BODILY INJURY, SERIOUS PROPERTY DAMAGE AND/OR SERIOUS PUBLIC IMPACT ("UNINTENDED USE").** Except for specific applications as expressly stated in this document, Unintended Use includes, without limitation, equipment used in nuclear facilities, equipment used in the aerospace industry, lifesaving and/or life supporting medical equipment, equipment used for automobiles, trains, ships and other transportation, traffic signaling equipment, equipment used to control combustions or explosions, safety devices, elevators and escalators, and devices related to power plant. **IF YOU USE PRODUCT FOR UNINTENDED USE, TOSHIBA ASSUMES NO LIABILITY FOR PRODUCT.** For details, please contact your TOSHIBA sales representative or contact us via our website.
- Do not disassemble, analyze, reverse-engineer, alter, modify, translate or copy Product, whether in whole or in part.
- Product shall not be used for or incorporated into any products or systems whose manufacture, use, or sale is prohibited under any applicable laws or regulations.
- The information contained herein is presented only as guidance for Product use. No responsibility is assumed by TOSHIBA for any infringement of patents or any other intellectual property rights of third parties that may result from the use of Product. No license to any intellectual property right is granted by this document, whether express or implied, by estoppel or otherwise.
- **ABSENT A WRITTEN SIGNED AGREEMENT, EXCEPT AS PROVIDED IN THE RELEVANT TERMS AND CONDITIONS OF SALE FOR PRODUCT, AND TO THE MAXIMUM EXTENT ALLOWABLE BY LAW, TOSHIBA (1) ASSUMES NO LIABILITY WHATSOEVER, INCLUDING WITHOUT LIMITATION, INDIRECT, CONSEQUENTIAL, SPECIAL, OR INCIDENTAL DAMAGES OR LOSS, INCLUDING WITHOUT LIMITATION, LOSS OF PROFITS, LOSS OF OPPORTUNITIES, BUSINESS INTERRUPTION AND LOSS OF DATA, AND (2) DISCLAIMS ANY AND ALL EXPRESS OR IMPLIED WARRANTIES AND CONDITIONS RELATED TO SALE, USE OF PRODUCT, OR INFORMATION, INCLUDING WARRANTIES OR CONDITIONS OF MERCHANTABILITY, FITNESS FOR A PARTICULAR PURPOSE, ACCURACY OF INFORMATION, OR NONINFRINGEMENT.**
- Product may include products using GaAs (Gallium Arsenide). GaAs is harmful to humans if consumed or absorbed, whether in the form of dust or vapor. Handle with care and do not break, cut, crush, grind, dissolve chemically or otherwise expose GaAs in Product.
- Do not use or otherwise make available Product or related software or technology for any military purposes, including without limitation, for the design, development, use, stockpiling or manufacturing of nuclear, chemical, or biological weapons or missile technology products (mass destruction weapons). Product and related software and technology may be controlled under the applicable export laws and regulations including, without limitation, the Japanese Foreign Exchange and Foreign Trade Law and the U.S. Export Administration Regulations. Export and re-export of Product or related software or technology are strictly prohibited except in compliance with all applicable export laws and regulations.
- Please contact your TOSHIBA sales representative for details as to environmental matters such as the RoHS compatibility of Product. Please use Product in compliance with all applicable laws and regulations that regulate the inclusion or use of controlled substances, including without limitation, the EU RoHS Directive. **TOSHIBA ASSUMES NO LIABILITY FOR DAMAGES OR LOSSES OCCURRING AS A RESULT OF NONCOMPLIANCE WITH APPLICABLE LAWS AND REGULATIONS.**

TOSHIBA

* Arm and Cortex are registered trademarks of Arm Limited (or its subsidiaries) in the US and/or elsewhere.

* All other company names, product names, and service names may be trademarks of their respective companies.