

# FAQ

## SiC MOSFET

### **Description**

This document introduces the Frequently Asked Questions and answers of SiC MOSFET.

## Table of Contents

Description.....	1
Table of Contents.....	2
List of Figures / List of Tables.....	3
1. What is SiC ? .....	4
2. Is it possible to connect multiple SiC MOSFETs in parallel ? .....	5
3. Is the back of the package of the SiC MOSFET insulated ?.....	6
4. Please let me know the characteristic of the body diode .....	7
5. If Si IGBT replaced with SiC MOSFET, what will change ?.....	8
6. Is there anything to note about the Gate drive voltage ?.....	9
RESTRICTIONS ON PRODUCT USE .....	11

## List of Figures

Figure 1. Application Use Case.....	4
Figure 2(a). $R_{DS(ON)} - T_a$ Characteristics (10A) .....	5
Figure 2(b). $R_{DS(ON)} - T_a$ Characteristics (18A) .....	5
Figure 3. $R_{DS(ON)}$ Distribution map.....	5
Figure 4. The example of SiC MOSFET Package.....	6
Figure 5. SiC MOSFET Equivalent Circuit .....	7
Figure 6. $I_{DR} - V_{DS}$ Characteristics .....	7
Figure 7-1. SiC MOSFET and Si IGBT Turn-on Switching Loss.....	8
Figure 7-2. SiC MOSFET and Si IGBT Turn-off Switching Loss.....	8
Figure 8. $R_{DS(ON)}$ Distribution map.....	9
Figure 9. $V_{th}$ Characteristic on temperature .....	9

## List of Tables

Table 1. Si, IGBT, SiC MOSFET Characteristics Comparison.....	8
Table 2. Electrical Characteristics( $Q_g$ ) in data sheet.....	10

# 1. What is SiC ?

Compared with commonly used Si products, SiC products can achieve low power loss due to low on-resistance and high-speed switching, especially in the high-voltage range. It is a semiconductor material that is expected to expand because it can also operate at high temperatures, among power devices expected to grow.

Silicon carbide (SiC) comprises silicon (Si) and carbon (C) atoms. Each atom is surrounded by four different atoms in the form of a regular tetrahedron. SiC is a compound semiconductor with the densest tetrahedral arrangement. SiC has many crystalline structures called polytypes that exhibit different physical properties because of periodic differences in the overlap of tetrahedrons. Compared to silicon, SiC has a wider energy gap where no electron states can exist (called a bandgap) between the valence band (i.e., an energy band filled with valence electrons) and the conduction band (i.e., an empty energy band in which electrons can be present). A wide bandgap provides a strong chemical bond among atoms and therefore a high electric breakdown field. SiC has an electric breakdown field roughly ten times that of silicon. And SiC is a power device with high withstand voltage and low voltage drop can be realized. In the case of the same withstand voltage, the on-resistance per unit area can be reduced compared with that of Si. In addition, while Si MOSFET is generally commercialized only up to about 1000V, SiC MOSFET is commercialized up to about 3300V because it can keep on-resistance low even at high withstand voltages.

SiC can realize MOSFET, the unipolar device that operate only with electronics even in high-voltage products, and the turn-off loss is smaller than bipolar devices because no tail current is generated. For this reason, SiC MOSFET is attracting attention because it can operate in the high switching frequency, which was difficult for Si IGBT, and has a great advantage of contributing to the miniaturization of passive components, making it ideal for power converting applications that require miniaturization and low-loss.

For example, it is widely used for OA and industrial switching power supplies, EV power supply equipment, welders for FA, and photovoltaic power generation applications. (Figure 1)

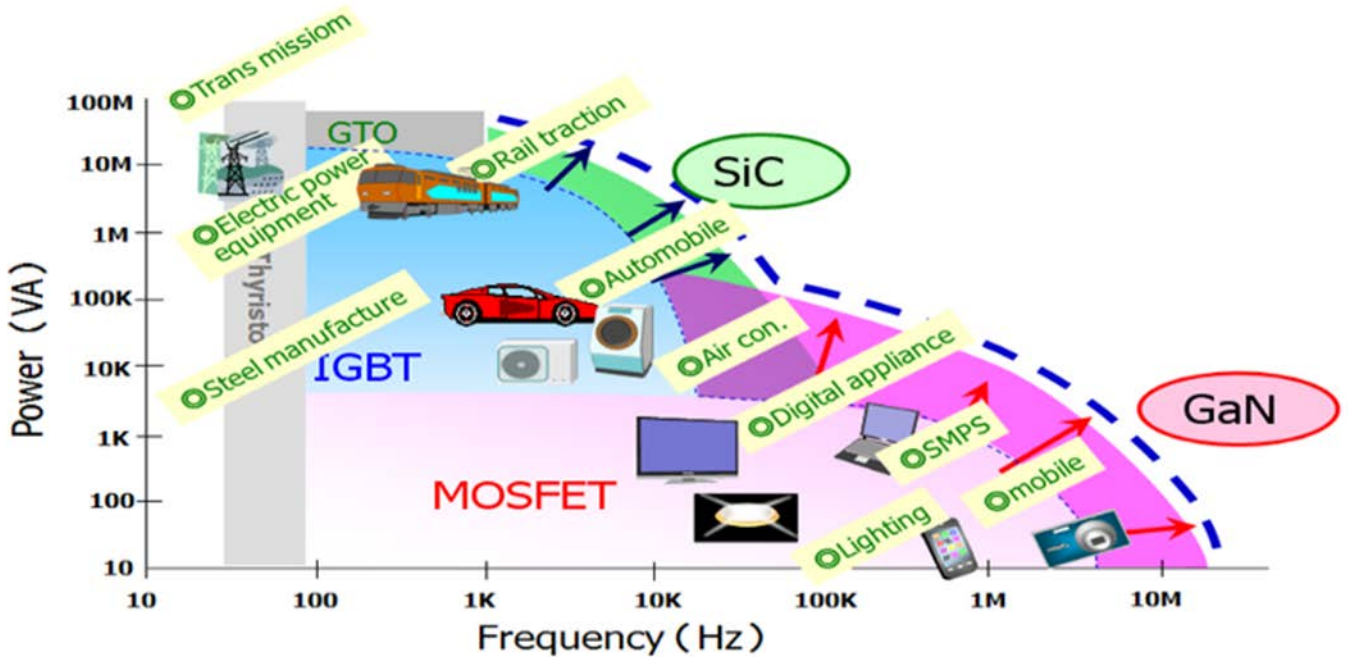

Figure 1. Application Use Case

## 2. Is it possible to connect multiple SiC MOSFETs in parallel?

SiC MOSFET can be connected and used in parallel in the same way as Si MOSFET.

For precautions on the parallel connection of MOSFET, refer to "MOSFET Application Notes \_ Parasitic Oscillator, Parallel Connection" on the website of Toshiba Device & Storage Co., Ltd.

Following three points must be noted for SiC MOSFET additionally.

1.  $R_{DS(ON)}$  of SiC MOSFET is temperature-sensitive, so care must be taken. Since it consists of a channel resistive component with a negative temperature coefficient and a drift layer resistive component with a positive temperature coefficient, current imbalance may occur because the on-resistance is not positive temperature coefficient in low temperature range (Figure 2)

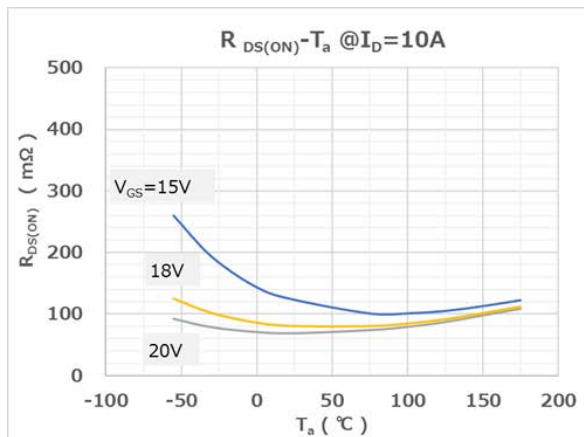

Figure 2(a).  $R_{DS(ON)}$  -  $T_a$  Characteristics (10A)

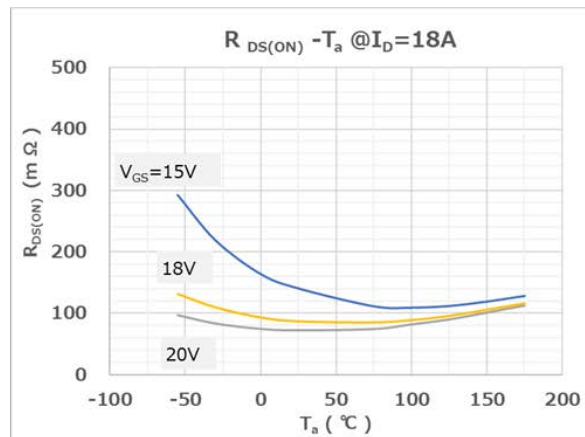

Figure 2(b).  $R_{DS(ON)}$  -  $T_a$  Characteristics (18A)

2. If the gated-forward bias is below 18V,  $R_{DS(ON)}$  become larger, and distribution wider. This can cause current to concentrate on a particular FET.

Therefore, the gate forward bias design is recommended to be between 18V to 20V.(Figure 3)

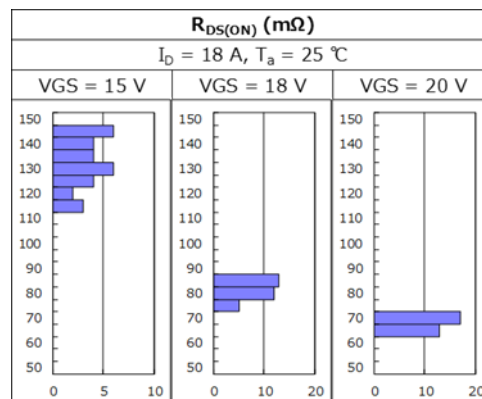

Figure 3.  $R_{DS(ON)}$  Distribution map

3. Our second-generation SiC MOSFET has a built-in SiC SBD in parallel to the pn body diode, and the forward voltage of SiC SBD has a positive temperature-coefficient, which helps to ensure a stable current balance. Therefore, there is less chance of imbalance in SiC MOSFET than in Si MOSFET when current is applied from the source to the drain.

### 3. Is the back of the package of the SiC MOSFET insulated?

The example of packaging of our SiC MOSFET is illustrated in Figure 4.

The current packaging of our SiC MOSFET has electrodes exposed and is not insulated on the back when viewed from the marked side. The back side is connected to the drain. The drain has a high voltage. When attaching a radiator plate connected to the ground, be careful that this portion (red circular mark) does not also come into contact with the peripheral components.

To calculate the creepage distance between the radiator plate and the product or to determine the distance between the terminals, please refer MOSFET package information and application note for the installation of the radiator plate on web site below.

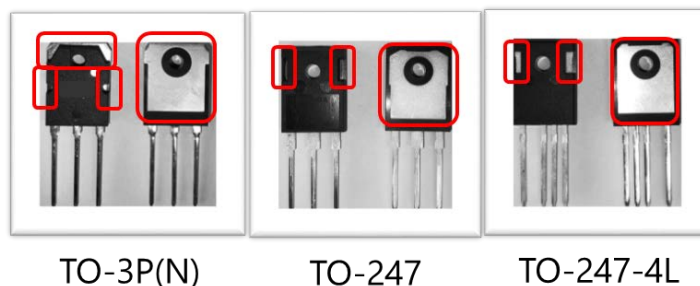

Figure 4. Example of SiC MOSFET Package

#### Web address

- Package & Packing Information

Japanese : <https://toshiba.semicon-storage.com/jp/design-support/package/MOSFET.html>

English : <https://toshiba.semicon-storage.com/ap-en/design-support/package/MOSFET.html>

- Application Note (Thermal Design and Attachment of a Thermal Fin)

Japanese : <https://toshiba.semicon-storage.com/info/docget.jsp?did=13412>

English : <https://toshiba.semicon-storage.com/info/docget.jsp?did=13417>

## 4. Please let me know the characteristic of the body diode

A typical SiC MOSFET body diode is a SiC pn junction diode. The reverse-recovery-time ( $t_{rr}$ ) of this pn-junction diode is faster than that of a normal Si pn junction diode.

Our SiC MOSFET has built-in SiC Schottky barrier diodes (SBDs) between SiC MOSFET's drain-source (Figure 5) to reduce inductance due to wires and circuit boards when the SBDs are connected externally, it makes device suitable reducing losses and noises caused by high-frequency switching. In addition, conduction loss can be reduced compared to SiC MOSFET without built-in SBDs. (Figure 6)

Built-in SBDs are also effective in improving reliability, reducing the risk of characteristics change, such as threshold voltage ( $V_{th}$ ) and on-resistance, due to defect that occur during long-term use. Our SiC MOSFET is designed with a built-in SiC SBD to prevent to energize pn-junction diodes, thus reducing the risk of characteristics change.

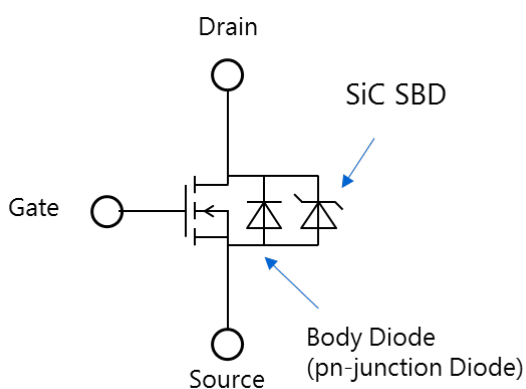

Figure 5. SiC MOSFET Equivalent Circuit

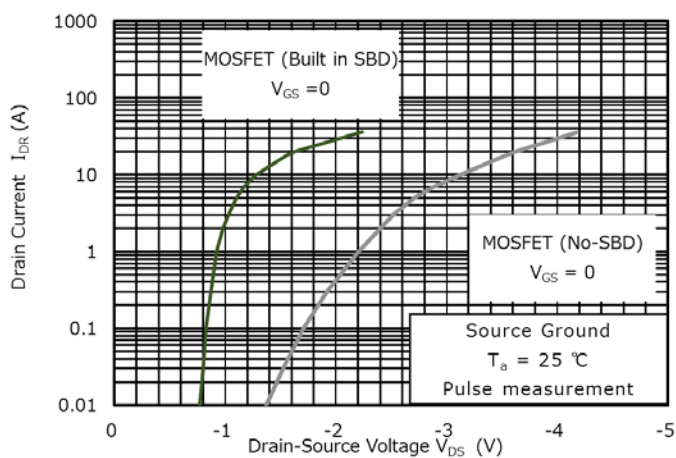

Figure 6.  $I_{DR} - V_{DS}$  Characteristics

## 5. If Si IGBT replaced with SiC MOSFET, what will change?

By replacing Si IGBT with SiC MOSFET, it is possible to reduce the size and weight of the equipments due to high-frequency operation, and to achieve highly efficient power conversion. The compared images of Si MOSFET/IGBT and SiC MOSFET characteristics are shown in Table 1.

\*: Fast Recovery Diode ★: Higher numbers indicate superiority

Electrical Characteristics Symbol (Improvement)	Relation on application use	Si material		SiC material
		MOSFET	IGBT (Built in *FRD)	MOSFET (Built in SBD)
High voltage range (Large)	High voltage range of set	★★	★★★	★★★
Switching Loss (Small)	Efficiency (Smallness of the loss at the Turn-on/off time)	★★	★	★★★
Forward voltage of Built in Diode (Small)	Efficiency (Smallness of the loss at the energy for Diode)	★★	★★	★★★
Reverse recovery time of Built in Diode $t_{rr}$ (Small)	Efficiency (Smallness of the loss at the Turn-on)	★	★★	★★★

Table 1. Si, IGBT, SiC MOSFET Characteristics Comparison

Figures 7-1 and 7-2 show the switching loss wave form when our SiC MOSFET and Si IGBT are switched at 25°C. Compared with IGBT, the turn-off loss and turn-on loss are reduced by 65%.

- ① The reduction of turn-off loss is influenced by the fact that SiC MOSFET has no minority carrier accumulation as in IGBT and no loss due to the tail current.
- ② The reduction in turn-on loss is due to the fact that SiC SBD built into SiC MOSFET has a smaller  $t_{rr} \cdot I_{rr}$  of affecting the loss than Si FRD built into Si IGBT.

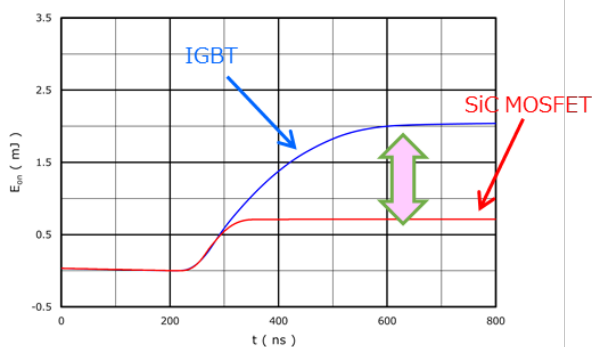

Figure 7-1. SiC MOSFET and Si IGBT Turn-on Switching Loss

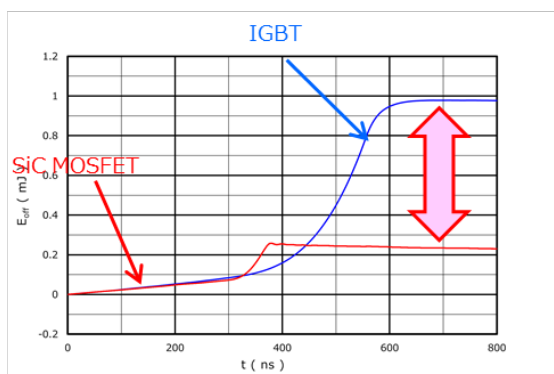

Figure 7-2. SiC MOSFET and Si IGBT Turn-off Switching Loss



## 6. Is there anything to note about the Gate drive voltage?

The explanation below illustrates our SiC MOSFET TW070J120B.

<Notes on Gate Control Voltage>

- ② Absolute max. rating- $10V \leq V_{GS} \leq 25V$
- ②To set the gate-voltage at turn-on to 18V to 20V.
- ③Set the gate voltage at turn-off to 0 to -5 V.
- ④The gate-to-source capacitance shall be sufficiently charged with the gate charge.

<Details>

①Should be within the absolute maximum ratings

The absolute max. rated  $V_{GS}=+25,-10V$  including the surge voltage (overshoot and undershoot) should not be exceeded.

②To set the gate-voltage at turn-on to 18V to 20V.

$R_{DS(ON)}$  is shown in Fig. 8. The on-resistance rises sharply below 18V in Figure 8.

By setting  $V_{GS}$  between 18V and 20V, you can reduce the variation with low on-resistance.

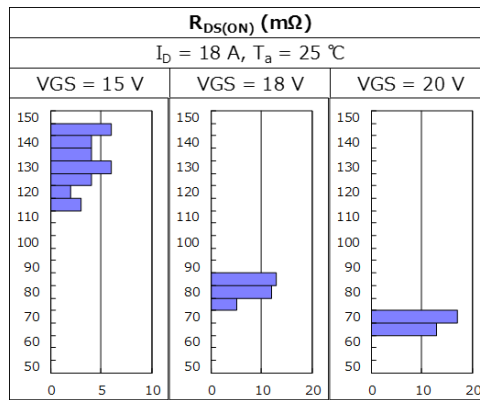

Figure 8.  $R_{DS(ON)}$  Distribution map

③Set the gate voltage at turn-off to 0 to-5 V.

The curve of  $V_{th} - T_a$  is shown in Fig. 9. The lower limit of the gate-threshold-voltage  $V_{th}$  is 4.2V at 25°C. In addition, as shown in the temperature characteristic curve,  $V_{th}$  has a negative temperature coefficient. It decreases around 1.5V at 25°C to 175°C. Please confirm the FET will not be turned on incorrectly because gate voltage during the off-period beyond  $V_{th}$  due to the effect of voltage fluctuation etc. during actual operation.

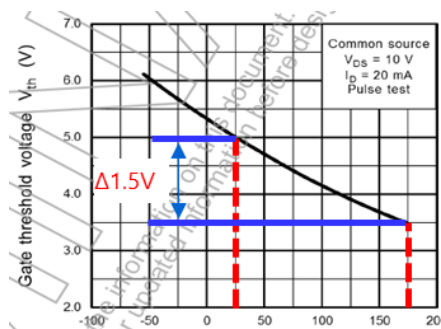

Figure 9.  $V_{th}$  Characteristic on temperature

④ Drive current

The gate-to-source capacitance must be charged with gate charges in order for  $V_{GS}$  to be applied and turned on. As shown in Table2,  $V_{GS}=0$  to 20V is typically 70nC. Provide a current that can sufficiently charge at the frequency to be used.

**6.3. Gate Charge Characteristics ( $T_a = 25\text{ }^\circ\text{C}$  unless otherwise specified)**

Characteristics	Symbol	Test Condition	Min	Typ.	Max	Unit
Total gate charge (gate-source plus gate-drain)	$Q_g$	$V_{DD} = 800\text{ V}, V_{GS} = 20\text{ V}, I_D = 36\text{ A}$	—	(70)	—	nC
Gate-source charge 1	$Q_{gs1}$		—	(20)	—	
Gate-drain charge	$Q_{gd}$		—	(25)	—	

Table 2. Electrical Characteristics( $Q_g$ ) in data sheet

## RESTRICTION ON PRODUCT USE

Toshiba Corporation and its subsidiaries and affiliates are collectively referred to as "TOSHIBA". Hardware, software and systems described in this document are collectively referred to as "Product".

- TOSHIBA reserves the right to make changes to the information in this document and related Product without notice.
- This document and any information herein may not be reproduced without prior written permission from TOSHIBA. Even with TOSHIBA's written permission, reproduction is permissible only if reproduction is without alteration/omission.
- Though TOSHIBA works continually to improve Product's quality and reliability, Product can malfunction or fail. Customers are responsible for complying with safety standards and for providing adequate designs and safeguards for their hardware, software and systems which minimize risk and avoid situations in which a malfunction or failure of Product could cause loss of human life, bodily injury or damage to property, including data loss or corruption. Before customers use the Product, create designs including the Product, or incorporate the Product into their own applications, customers must also refer to and comply with (a) the latest versions of all relevant TOSHIBA information, including without limitation, this document, the specifications, the data sheets and application notes for Product and the precautions and conditions set forth in the "TOSHIBA Semiconductor Reliability Handbook" and (b) the instructions for the application with which the Product will be used with or for. Customers are solely responsible for all aspects of their own product design or applications, including but not limited to (a) determining the appropriateness of the use of this Product in such design or applications; (b) evaluating and determining the applicability of any information contained in this document, or in charts, diagrams, programs, algorithms, sample application circuits, or any other referenced documents; and (c) validating all operating parameters for such designs and applications. **TOSHIBA ASSUMES NO LIABILITY FOR CUSTOMERS' PRODUCT DESIGN OR APPLICATIONS.**
- **PRODUCT IS NEITHER INTENDED NOR WARRANTED FOR USE IN EQUIPMENTS OR SYSTEMS THAT REQUIRE EXTRAORDINARILY HIGH LEVELS OF QUALITY AND/OR RELIABILITY, AND/OR A MALFUNCTION OR FAILURE OF WHICH MAY CAUSE LOSS OF HUMAN LIFE, BODILY INJURY, SERIOUS PROPERTY DAMAGE AND/OR SERIOUS PUBLIC IMPACT ("UNINTENDED USE").** Except for specific applications as expressly stated in this document, Unintended Use includes, without limitation, equipment used in nuclear facilities, equipment used in the aerospace industry, lifesaving and/or life supporting medical equipment, equipment used for automobiles, trains, ships and other transportation, traffic signaling equipment, equipment used to control combustions or explosions, safety devices, elevators and escalators, and devices related to power plant. **IF YOU USE PRODUCT FOR UNINTENDED USE, TOSHIBA ASSUMES NO LIABILITY FOR PRODUCT.** For details, please contact your TOSHIBA sales representative or contact us via our website.
- Do not disassemble, analyze, reverse-engineer, alter, modify, translate or copy Product, whether in whole or in part.
- Product shall not be used for or incorporated into any products or systems whose manufacture, use, or sale is prohibited under any applicable laws or regulations.
- The information contained herein is presented only as guidance for Product use. No responsibility is assumed by TOSHIBA for any infringement of patents or any other intellectual property rights of third parties that may result from the use of Product. No license to any intellectual property right is granted by this document, whether express or implied, by estoppel or otherwise.
- **ABSENT A WRITTEN SIGNED AGREEMENT, EXCEPT AS PROVIDED IN THE RELEVANT TERMS AND CONDITIONS OF SALE FOR PRODUCT, AND TO THE MAXIMUM EXTENT ALLOWABLE BY LAW, TOSHIBA (1) ASSUMES NO LIABILITY WHATSOEVER, INCLUDING WITHOUT LIMITATION, INDIRECT, CONSEQUENTIAL, SPECIAL, OR INCIDENTAL DAMAGES OR LOSS, INCLUDING WITHOUT LIMITATION, LOSS OF PROFITS, LOSS OF OPPORTUNITIES, BUSINESS INTERRUPTION AND LOSS OF DATA, AND (2) DISCLAIMS ANY AND ALL EXPRESS OR IMPLIED WARRANTIES AND CONDITIONS RELATED TO SALE, USE OF PRODUCT, OR INFORMATION, INCLUDING WARRANTIES OR CONDITIONS OF MERCHANTABILITY, FITNESS FOR A PARTICULAR PURPOSE, ACCURACY OF INFORMATION, OR NONINFRINGEMENT.**
- Do not use or otherwise make available Product or related software or technology for any military purposes, including without limitation, for the design, development, use, stockpiling or manufacturing of nuclear, chemical, or biological weapons or missile technology products (mass destruction weapons). Product and related software and technology may be controlled under the applicable export laws and regulations including, without limitation, the Japanese Foreign Exchange and Foreign Trade Law and the U.S. Export Administration Regulations. Export and re-export of Product or related software or technology are strictly prohibited except in compliance with all applicable export laws and regulations.
  - Please contact your TOSHIBA sales representative for details as to environmental matters such as the RoHS compatibility of Product. Please use Product in compliance with all applicable laws and regulations that regulate the inclusion or use of controlled substances, including without limitation, the EU RoHS Directive. **TOSHIBA ASSUMES NO LIABILITY FOR DAMAGES OR LOSSES OCCURRING AS A RESULT OF NONCOMPLIANCE WITH APPLICABLE LAWS AND REGULATIONS.**