

Photocouplers Photorelay

TLP3547, TLP3547F

1. Applications

- Mechanical relay replacements
- Factory Automation (FA)
- Programmable Logic Controllers (PLCs)
- Measuring Instruments
- ATE (Automatic Test Equipment)

2. General

The TLP3547 and TLP3547F photorelay consist of a photo MOSFET optically coupled to an infrared LED. It is housed in a 8-pin DIP package. The low ON-state resistance and the high permissible ON-state current of the TLP3547 and TLP3547F make it suitable for power line control applications.

3. Features

- (1) Normally opened (1-Form-A)
- (2) OFF-state output terminal voltage: 60 V (min)
- (3) Trigger LED current: 5.0 mA (max)
- (4) ON-state current: 5 A (max) (A connection)
- (5) ON-state resistance: 50 mΩ (max) (A connection)
- (6) Isolation voltage: 2500 Vrms (min)
- (7) Safety standards

UL-recognized: UL 1577, File No.E67349

cUL-recognized: CSA Component Acceptance Service No.5A File No.E67349

UL-recognized: UL 508, File No.E499232 (**Note 1**)

VDE-approved: EN 60747-5-5 (**Note 2**)

Note 1: Please refer Absolute Maximum Ratings (UL-recognized UL 508) for UL 508 products.

Note 2: When a VDE approved type is needed, please designate the **Option (D4)**.

4. Mechanical Parameters

Characteristics	7.62-mm Pitch TLP3547	10.16-mm Pitch TLP3547F	Unit
Creepage distances	7.0 (min)	8.0 (min)	mm
Clearance distances	7.0 (min)	8.0 (min)	
Internal isolation thickness	0.4 (min)	0.4 (min)	

Start of commercial production

2016-05

5. Packaging (Note)

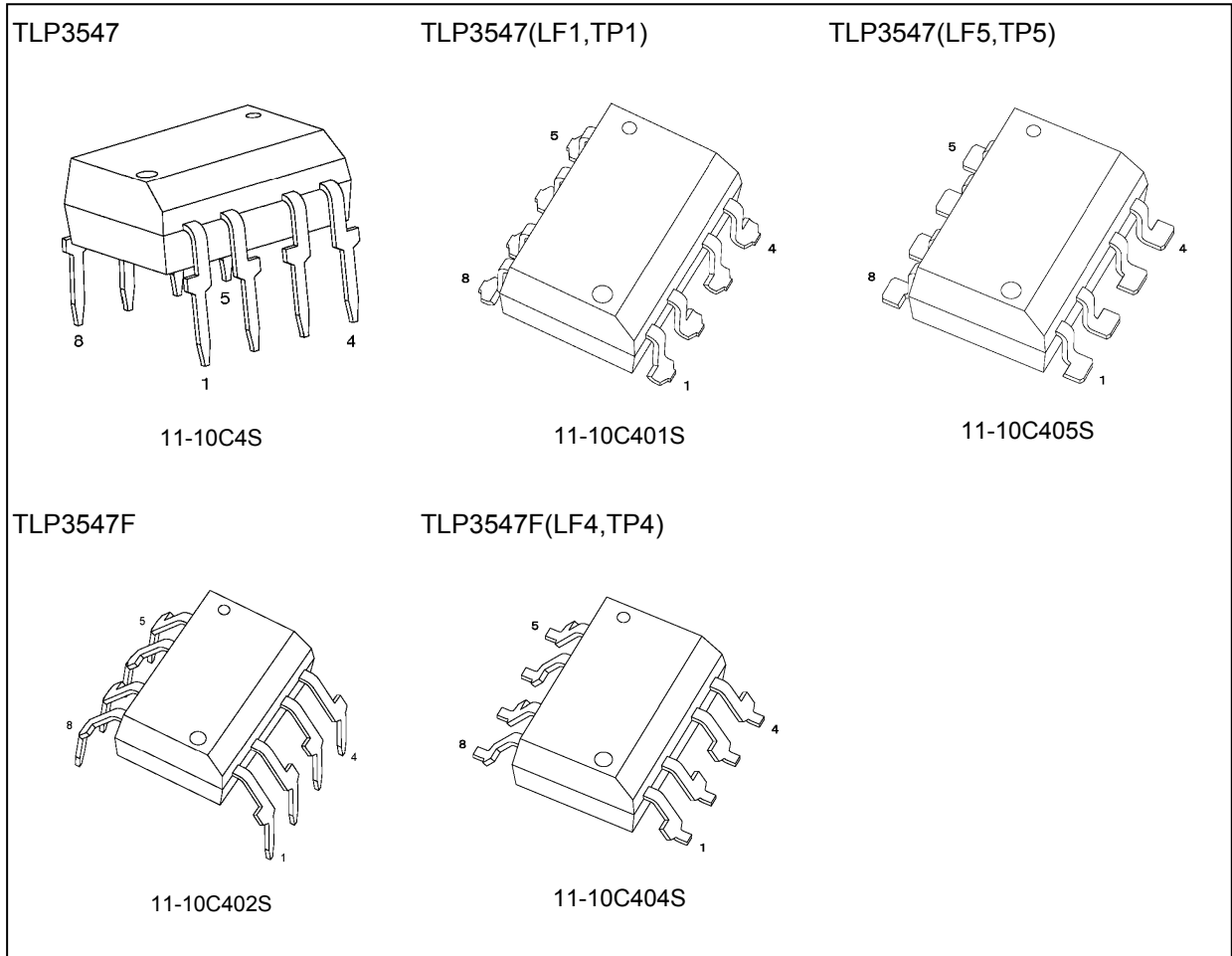

Note: Through-hole type: TLP3547, TLP3547F
 Lead forming option: (LF1), (LF4), (LF5)
 Taping option: (TP1), (TP4), (TP5)

6. Pin Assignment

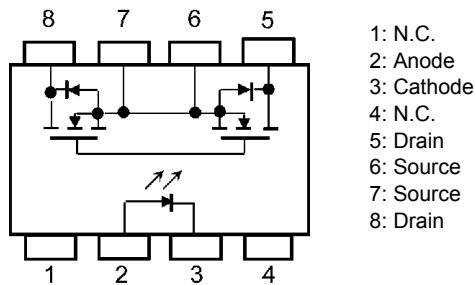

7. Internal Circuit

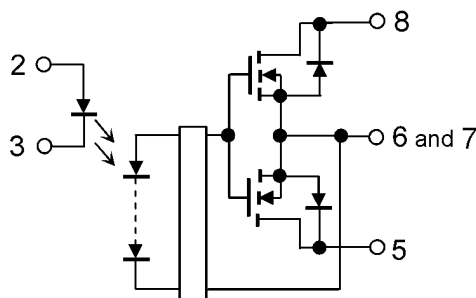

8. Absolute Maximum Ratings (Note) (Unless otherwise specified, $T_a = 25\text{ }^\circ\text{C}$)

	Characteristics	Symbol	Note	Rating	Unit
LED	Input forward current	I_F		30	mA
	Input forward current derating ($T_a \geq 25\text{ }^\circ\text{C}$)	$\Delta I_F / \Delta T_a$		-0.3	mA/ $^\circ\text{C}$
	Input forward current (pulsed) (100 μs pulse, 100 pps)	I_{FP}		1	A
	Input reverse voltage	V_R		5	V
	Input power dissipation	P_D		50	mW
	Input power dissipation derating ($T_a \geq 25\text{ }^\circ\text{C}$)	$\Delta P_D / \Delta T_a$		-0.5	mW/ $^\circ\text{C}$
	Junction temperature	T_j		125	$^\circ\text{C}$
Detector	OFF-state output terminal voltage	V_{OFF}		60	V
	ON-state current (A connection)	I_{ON}	(Note 1)	5	A
	ON-state current (B connection)			5	
	ON-state current (C connection)			10	
	ON-state current derating (A connection) ($T_a \geq 25\text{ }^\circ\text{C}$)	$\Delta I_{ON} / \Delta T_a$	(Note 1)	-50	mA/ $^\circ\text{C}$
	ON-state current derating (B connection) ($T_a \geq 25\text{ }^\circ\text{C}$)			-50	
	ON-state current derating (C connection) ($T_a \geq 25\text{ }^\circ\text{C}$)			-100	
	ON-state current (pulsed) ($t = 100\text{ ms}$, duty = 1/10)	I_{ONP}		15	A
	Output power dissipation	P_O		750	mW
	Output power dissipation derating ($T_a \geq 25\text{ }^\circ\text{C}$)	$\Delta P_O / \Delta T_a$		-7.5	mW/ $^\circ\text{C}$
	Junction temperature	T_j		125	$^\circ\text{C}$
Common	Storage temperature	T_{stg}		-55 to 125	$^\circ\text{C}$
	Operating temperature	T_{opr}		-40 to 85	
	Lead soldering temperature (10 s)	T_{sol}		260	
	Isolation voltage AC, 60 s, R.H. $\leq 60\%$	BV_S	(Note 2)	2500	

Note: Using continuously under heavy loads (e.g. the application of high temperature/current/voltage and the significant change in temperature, etc.) may cause this product to decrease in the reliability significantly even if the operating conditions (i.e. operating temperature/current/voltage, etc.) are within the absolute maximum ratings.

Please design the appropriate reliability upon reviewing the Toshiba Semiconductor Reliability Handbook ("Handling Precautions"/"Derating Concept and Methods") and individual reliability data (i.e. reliability test report and estimated failure rate, etc).

Note 1: For an application circuit example, see Chapter 16.2.

Note 2: This device is considered as a two-terminal device: Pins 1, 2, 3 and 4 are shorted together, and pins 5, 6, 7 and 8 are shorted together.

9. Recommended Operating Conditions (Note)

Characteristics	Symbol	Note	Min	Typ.	Max	Unit
Supply voltage	V_{DD}		—	—	48	V
Input forward current	I_F		—	5	25	mA
ON-state current (A connection)	I_{ON}		—	—	5	A
Operating temperature	T_{opr}		-40	—	85	°C

Note: The recommended operating conditions are given as a design guide necessary to obtain the intended performance of the device. Each parameter is an independent value. When creating a system design using this device, the electrical characteristics specified in this data sheet should also be considered.

10. Absolute Maximum Ratings (UL-recognized: UL 508) (Note) (Unless otherwise specified, $T_a = 25\text{ °C}$)

	Characteristics	Symbol	Note	Rating	Unit
LED	Input forward current	I_F		30	mA
	Input forward current derating ($T_a \geq 25\text{ °C}$)	$\Delta I_F/\Delta T_a$		-0.3	mA/°C
	Input forward current (pulsed) (100 μ s pulse, 100 pps)	I_{FP}		1	A
	Input reverse voltage	V_R		5	V
	Input power dissipation	P_D		50	mW
	Input power dissipation derating ($T_a \geq 25\text{ °C}$)	$\Delta P_D/\Delta T_a$		-0.5	mW/°C
	Junction temperature	T_j		105	°C
Detector	OFF-state output terminal voltage	V_{OFF}		60	V
	ON-state current (A connection)	I_{ON}	(Note 1)	5	A
	ON-state current (B connection)			5	
	ON-state current (C connection)			10	
	ON-state current derating (A connection) ($T_a \geq 25\text{ °C}$)	$\Delta I_{ON}/\Delta T_a$	(Note 1)	-50	mA/°C
	ON-state current derating (B connection) ($T_a \geq 25\text{ °C}$)			-50	
	ON-state current derating (C connection) ($T_a \geq 25\text{ °C}$)			-100	
	ON-state current (pulsed) ($t = 100\text{ ms}$, duty = 1/10)	I_{ONP}		15	A
	Output power dissipation	P_O		750	mW
	Output power dissipation derating ($T_a \geq 25\text{ °C}$)	$\Delta P_O/\Delta T_a$		-7.5	mW/°C
Junction temperature	T_j		105	°C	
Common	Storage temperature	T_{stg}		-55 to 125	°C
	Case temperature	T_c		105	°C
	Operating temperature	T_{opr}		-40 to 85	°C
	Lead soldering temperature (10 s)	T_{sol}		260	°C
	Isolation voltage (AC, 60 s, R.H. $\leq 60\%$)	BV_S	(Note 2)	2500	Vrms

Note: Using continuously under heavy loads (e.g. the application of high temperature/current/voltage and the significant change in temperature, etc.) may cause this product to decrease in the reliability significantly even if the operating conditions (i.e. operating temperature/current/voltage, etc.) are within the absolute maximum ratings.

Please design the appropriate reliability upon reviewing the Toshiba Semiconductor Reliability Handbook ("Handling Precautions"/"Derating Concept and Methods") and individual reliability data (i.e. reliability test report and estimated failure rate, etc).

Note 1: For an application circuit example, see Chapter 16.2.

Note 2: This device is considered as a two-terminal device: Pins 1, 2, 3 and 4 are shorted together, and pins 5, 6, 7 and 8 are shorted together.

11. Recommended Operating Conditions (UL-recognized: UL 508) (Note)

Characteristics	Symbol	Note	Min	Typ.	Max	Unit
Supply voltage	V_{DD}		—	—	48	V
Input forward current	I_F	(Note 1)	—	5	19.5	mA
ON-state current(A connection)	I_{ON}	(Note 1)	—	—	3.3	A
Operating temperature	T_{opr}		-20	—	85	°C

Note: The recommended operating conditions are given as a design guide necessary to obtain the intended performance of the device. Each parameter is an independent value. When creating a system design using this device, the electrical characteristics specified in this data sheet should also be considered.

Note 1: The above recommended operating conditions are at $T_a = 60\text{ °C}$.

However, within the derating range of the characteristic curves of " $I_F - T_a$ ", " $I_{ON} - T_a$ ", it can be used up to 85 °C .

12. Electrical Characteristics (Unless otherwise specified, $T_a = 25\text{ °C}$)

	Characteristics	Symbol	Note	Test Condition	Min	Typ.	Max	Unit
LED	Input forward voltage	V_F		$I_F = 10\text{ mA}$	1.50	1.64	1.80	V
	Input reverse current	I_R		$V_R = 5\text{ V}$	—	—	10	μA
	Input capacitance	C_t		$V = 0\text{ V}, f = 1\text{ MHz}$	—	70	—	pF
Detector	OFF-state current	I_{OFF}		$V_{OFF} = 60\text{ V}$	—	0.01	1	μA
	Output capacitance	C_{OFF}		$V = 0\text{ V}, f = 1\text{ MHz}$	—	850	—	pF

13. Coupled Electrical Characteristics (Unless otherwise specified, $T_a = 25\text{ °C}$)

Characteristics	Symbol	Note	Test Condition	Min	Typ.	Max	Unit
Trigger LED current	I_{FT}		$I_{ON} = 1\text{ A}$	—	0.28	5.0	mA
Return LED current	I_{FC}		$I_{OFF} = 1\text{ }\mu\text{A}$	0.01	0.19	—	
ON-state resistance (A connection)	R_{ON}	(Note 1)	$I_{ON} = 1\text{ A}, I_F = 5\text{ mA}, t < 1\text{ s}$	—	22	50	m Ω
ON-state resistance (B connection)			$I_{ON} = 1\text{ A}, I_F = 2\text{ mA}, t < 1\text{ s}$	—	—	25	
ON-state resistance (C connection)			$I_{ON} = 1\text{ A}, I_F = 2\text{ mA}, t < 1\text{ s}$	—	—	13	

Note 1: For an application circuit example, see Chapter 16.2.

14. Isolation Characteristics (Unless otherwise specified, $T_a = 25\text{ °C}$)

Characteristics	Symbol	Note	Test Condition	Min	Typ.	Max	Unit
Total capacitance (input to output)	C_S	(Note 1)	$V_S = 0\text{ V}, f = 1\text{ MHz}$	—	0.8	—	pF
Isolation resistance	R_S	(Note 1)	$V_S = 500\text{ V}, R.H. \leq 60\%$	5×10^{10}	10^{14}	—	Ω
Isolation voltage	BV_S	(Note 1)	AC, 60 s	2500	—	—	V _{rms}

Note 1: This device is considered as a two-terminal device: Pins 1, 2, 3 and 4 are shorted together, and pins 5, 6, 7 and 8 are shorted together.

15. Switching Characteristics (Unless otherwise specified, $T_a = 25\text{ °C}$)

Characteristics	Symbol	Note	Test Condition	Min	Typ.	Max	Unit
Turn-on time	t_{ON}		See Fig. 15.1.	—	2.5	5.0	ms
Turn-off time	t_{OFF}		$R_L = 200\text{ }\Omega, V_{DD} = 20\text{ V}, I_F = 5\text{ mA}$	—	0.1	1.0	

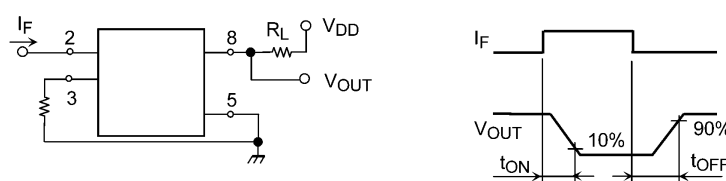

Fig. 15.1 Switching Time Test Circuit and Waveform

16. Characteristics Curves and Circuit Connections

16.1. Characteristics Curves (Note)

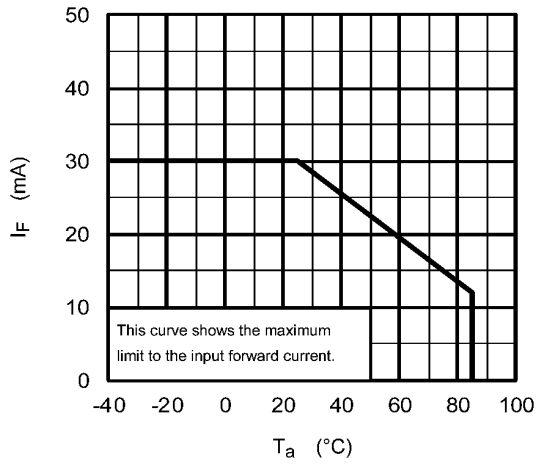

Fig. 16.1.1 $I_F - T_a$

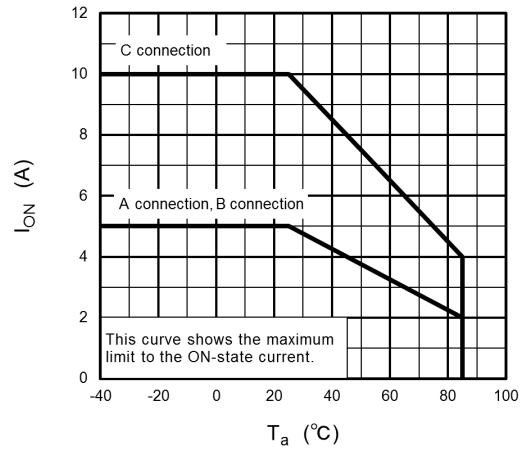

Fig. 16.1.2 $I_{ON} - T_a$

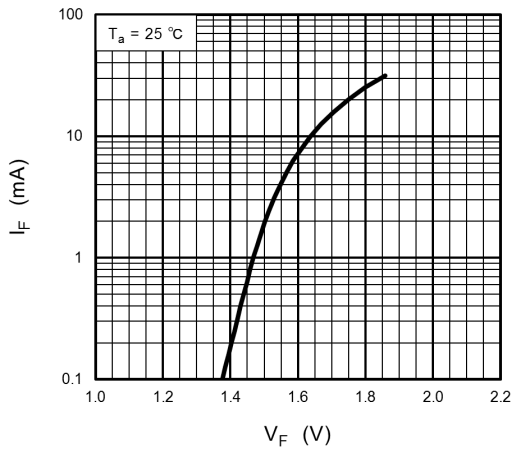

Fig. 16.1.3 $I_F - V_F$

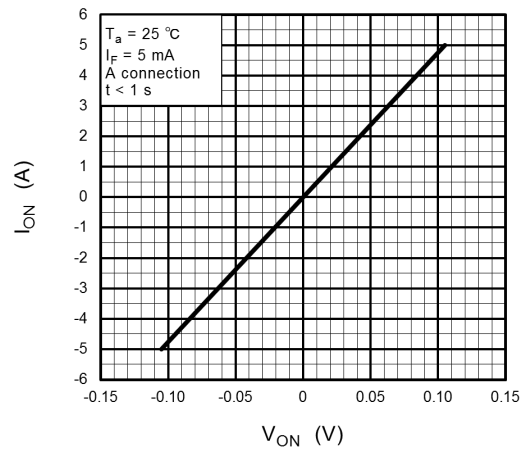

Fig. 16.1.4 $I_{ON} - V_{ON}$

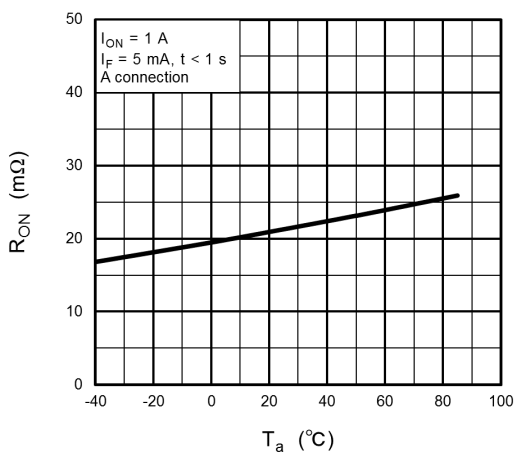

Fig. 16.1.5 $R_{ON} - T_a$

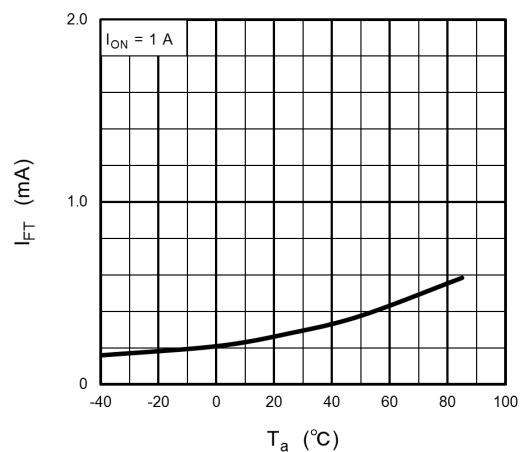

Fig. 16.1.6 $I_{FT} - T_a$

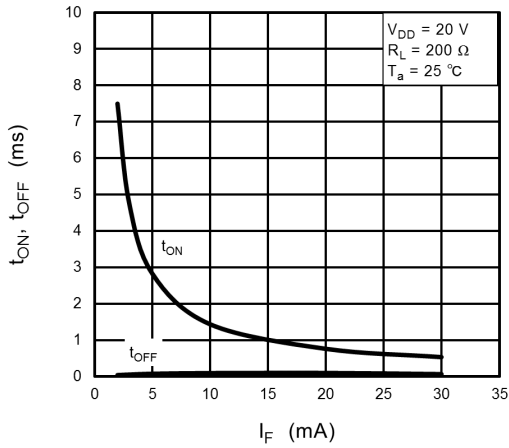

Fig. 16.1.7 $t_{ON}, t_{OFF} - I_F$

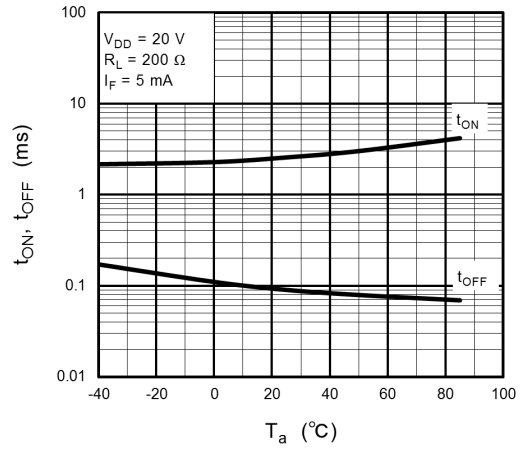

Fig. 16.1.8 $t_{ON}, t_{OFF} - T_a$

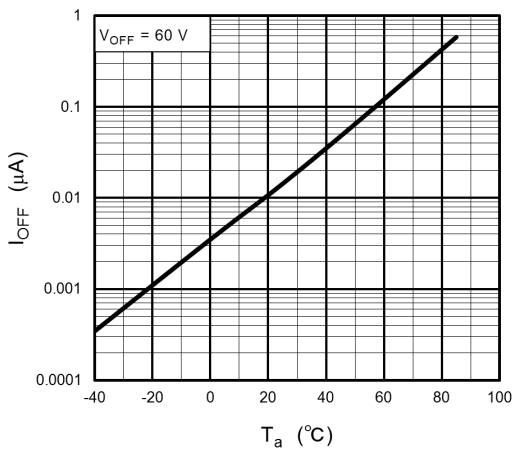

Fig. 16.1.9 $I_{OFF} - T_a$

Note: The above characteristics curves are presented for reference only and not guaranteed by production test, unless otherwise noted.

16.2. Circuit Connections

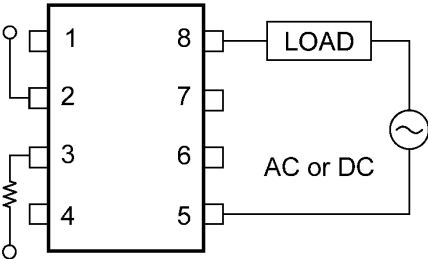

Fig. 16.2.1 A Connection

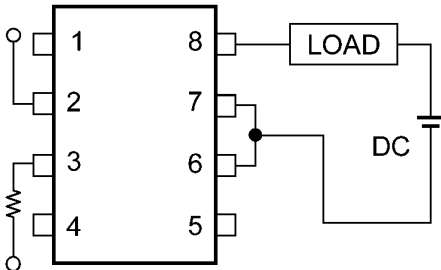

Fig. 16.2.2 B Connection

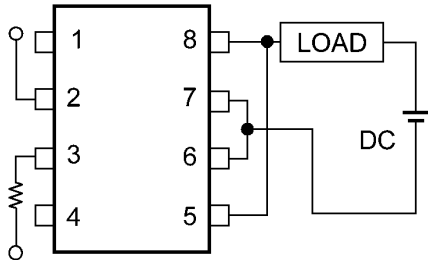

Fig. 16.2.3 C Connection

17. Soldering and Storage

17.1. Precautions for Soldering

The soldering temperature should be controlled as closely as possible to the conditions shown below, irrespective of whether a soldering iron or a reflow soldering method is used.

- When using soldering reflow.

The soldering temperature profile is based on the package surface temperature.

(See the figure shown below, which is based on the package surface temperature.)

Reflow soldering must be performed once or twice.

The mounting should be completed with the interval from the first to the last mountings being 2 weeks.

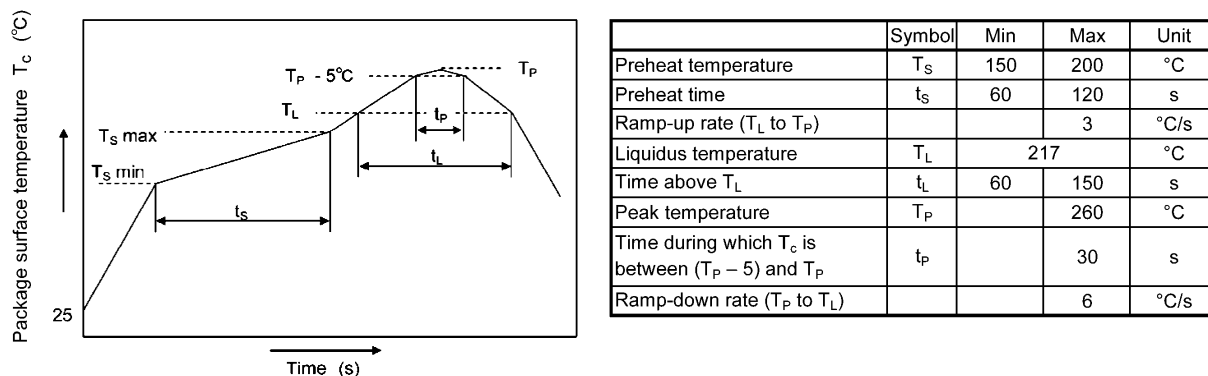

Fig. 17.1.1 An Example of a Temperature Profile When Lead(Pb)-Free Solder Is Used

- When using soldering flow
Preheat the device at a temperature of 150 °C (package surface temperature) for 60 to 120 seconds.
Mounting condition of 260 °C within 10 seconds is recommended.
Flow soldering must be performed once.
- When using soldering Iron
Complete soldering within 10 seconds for lead temperature not exceeding 260 °C or within 3 seconds not exceeding 350 °C
Heating by soldering iron must be done only once per lead.

17.2. Precautions for General Storage

- Avoid storage locations where devices may be exposed to moisture or direct sunlight.
- Follow the precautions printed on the packing label of the device for transportation and storage.
- Keep the storage location temperature and humidity within a range of 5 °C to 35 °C and 45 % to 75 %, respectively.
- Do not store the products in locations with poisonous gases (especially corrosive gases) or in dusty conditions.
- Store the products in locations with minimal temperature fluctuations. Rapid temperature changes during storage can cause condensation, resulting in lead oxidation or corrosion, which will deteriorate the solderability of the leads.
- When restoring devices after removal from their packing, use anti-static containers.
- Do not allow loads to be applied directly to devices while they are in storage.
- If devices have been stored for more than two years under normal storage conditions, it is recommended that you check the leads for ease of soldering prior to use.

18. Land Pattern Dimensions (for reference only)

(Unit: mm)

TLP3547

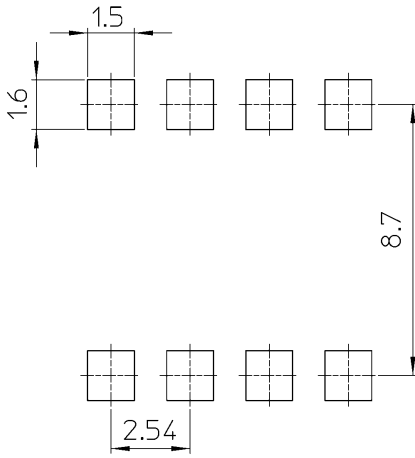

Fig. 18.1 Lead forming and taping option (LF1), (TP1), (LF5), (TP5)

TLP3547F

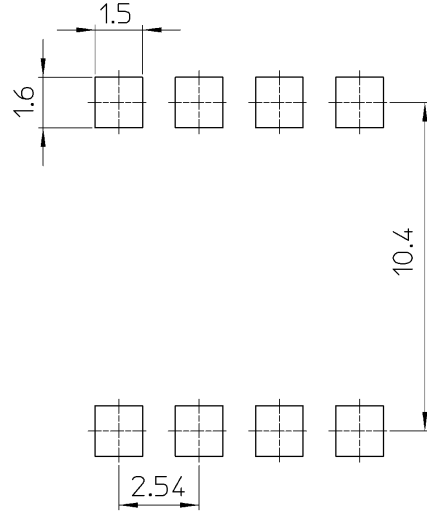
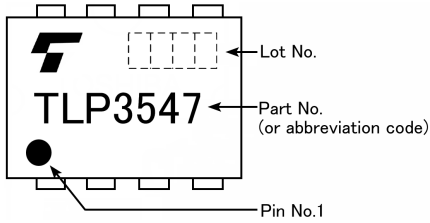

Fig. 18.2 Lead forming and taping option (LF4), (TP4)

19. Marking

TLP3547



TLP3547F

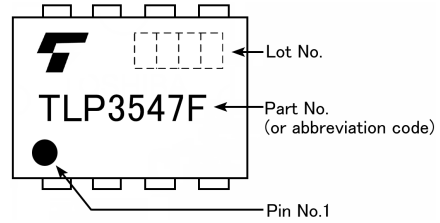

20. EN 60747-5-5 Option (D4) Specification

- Part number: TLP3547, TLP3547F (**Note**)
- The following part naming conventions are used for the devices that have been qualified according to option (D4) of EN 60747.

Example: TLP3547(D4,TP1,F)

D4: EN 60747 option

TP1: Tape type

F: [[G]]/RoHS COMPATIBLE (**Note 1**)

Note: Use TOSHIBA standard type number for safety standard application.
e.g., TLP3547(D4,TP1,F) → TLP3547

Note 1: Please contact your Toshiba sales representative for details on environmental information such as the product's RoHS compatibility.

RoHS is the Directive 2011/65/EU of the European Parliament and of the Council of 8 June 2011 on the restriction of the use of certain hazardous substances in electrical and electronic equipment.

Description		Symbol	Rating	Unit
Application classification				
for rated mains voltage ≤ 300 Vrms			I-IV	—
for rated mains voltage ≤ 600 Vrms			I-III	—
Climatic classification			40 / 85 / 21	—
Pollution degree			2	—
Maximum operating insulation voltage	TLPxxx type	VIORM	890	Vpk
	TLPxxxF type		1140	
Input to output test voltage, Method A $V_{pr} = 1.6 \times VIORM$, type and sample test $t_p = 10$ s, partial discharge < 5 pC	TLPxxx type	Vpr	1424	Vpk
	TLPxxxF type		1824	
Input to output test voltage, Method B $V_{pr} = 1.875 \times VIORM$, 100% production test $t_p = 1$ s, partial discharge < 5 pC	TLPxxx type	Vpr	1670	Vpk
	TLPxxxF type		2140	
Highest permissible Overvoltage (transient overvoltage, $t_{pr} = 60$ s)	TLPxxx type	VTR	6000	Vpk
	TLPxxxF type			
Safety limiting values (max. permissible ratings in case of fault, also refer to thermal derating curve)				
current (input current I_F , $P_{so} = 0$)		I_{si}	400	mA
power (output or total power dissipation)		P_{so}	700	mW
temperature		T_s	150	$^{\circ}\text{C}$
Insulation resistance	$V_{IO} = 500$ V, $T_a = 25$ $^{\circ}\text{C}$ $V_{IO} = 500$ V, $T_a = 100$ $^{\circ}\text{C}$ $V_{IO} = 500$ V, $T_a = T_s$	R_{si}	$\geq 10^{12}$ $\geq 10^{11}$ $\geq 10^9$	Ω

Fig. 20.1 EN 60747 Insulation Characteristics

Table Insulation Related Specifications (Note)

Insulation Related Parameters	Symbol	TLP3547	TLP3547F
Minimum creepage distance	Cr	7.0 mm	8.0 mm
Minimum clearance	Cl	7.0 mm	8.0 mm
Minimum insulation thickness	ti	0.4 mm	0.4 mm
Comparative tracking index	CTI	175	175

Note: If a printed circuit is incorporated, the creepage distance and clearance may be reduced below this value. (e.g., at a standard distance between soldering eye centers of 7.5 mm). If this is not permissible, the user shall take suitable measures.

Note: This photocoupler is suitable for **safe electrical isolation** only within the safety limit data. Maintenance of the safety data shall be ensured by means of protective circuits.



Fig. 20.2 Marking on Packing

TLP3547

TLP3547F

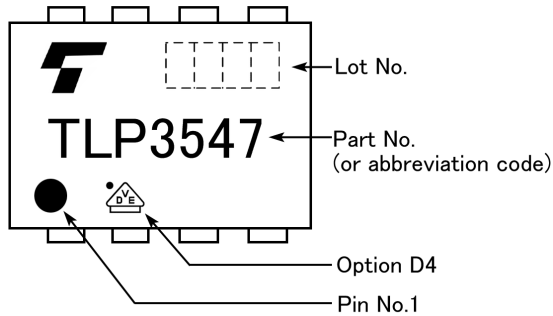

Fig. 20.3 Marking Example (Note)

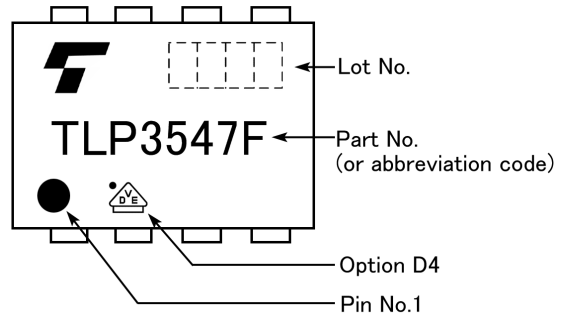

Fig. 20.4 Marking Example (Note)

Note: The above marking is applied to the photocouplers that have been qualified according to option (D4) of EN 60747.

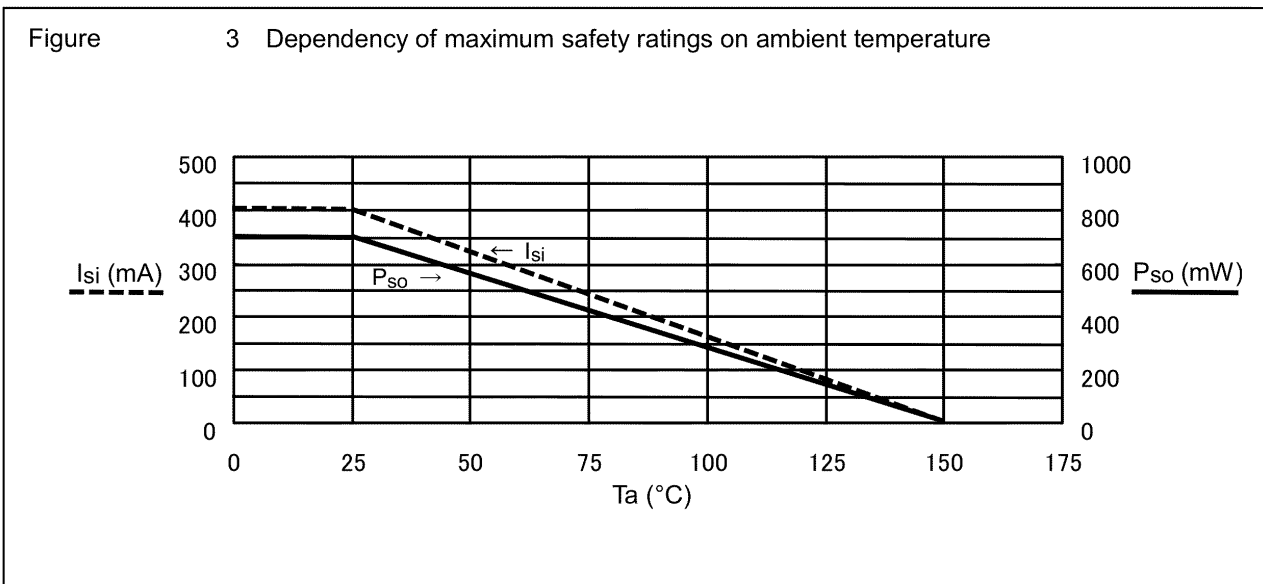
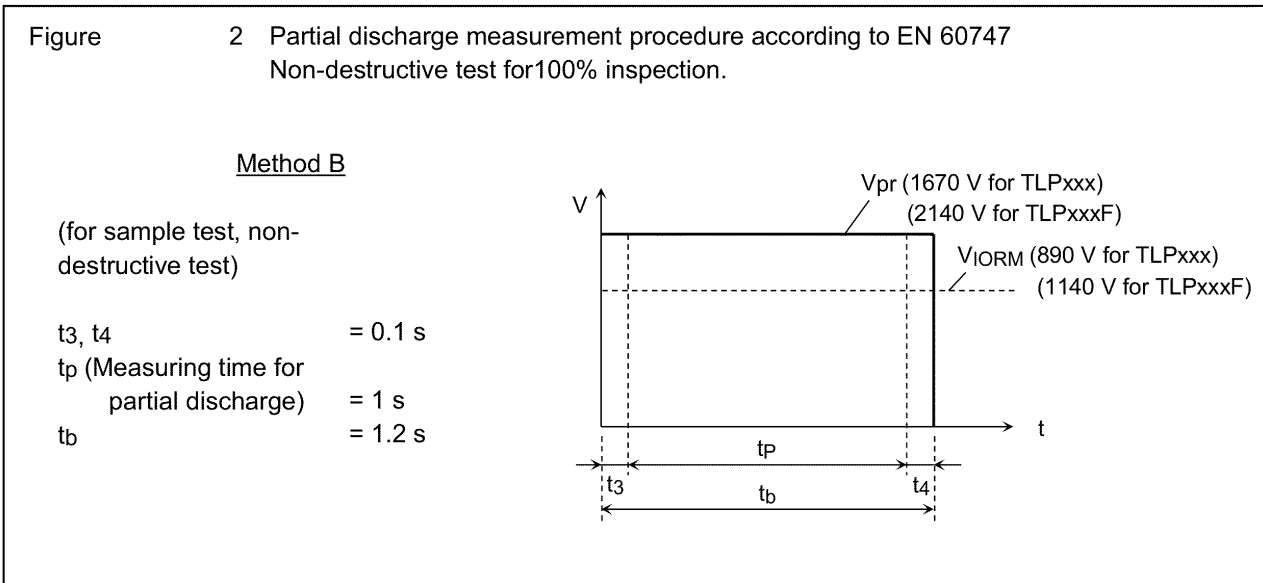
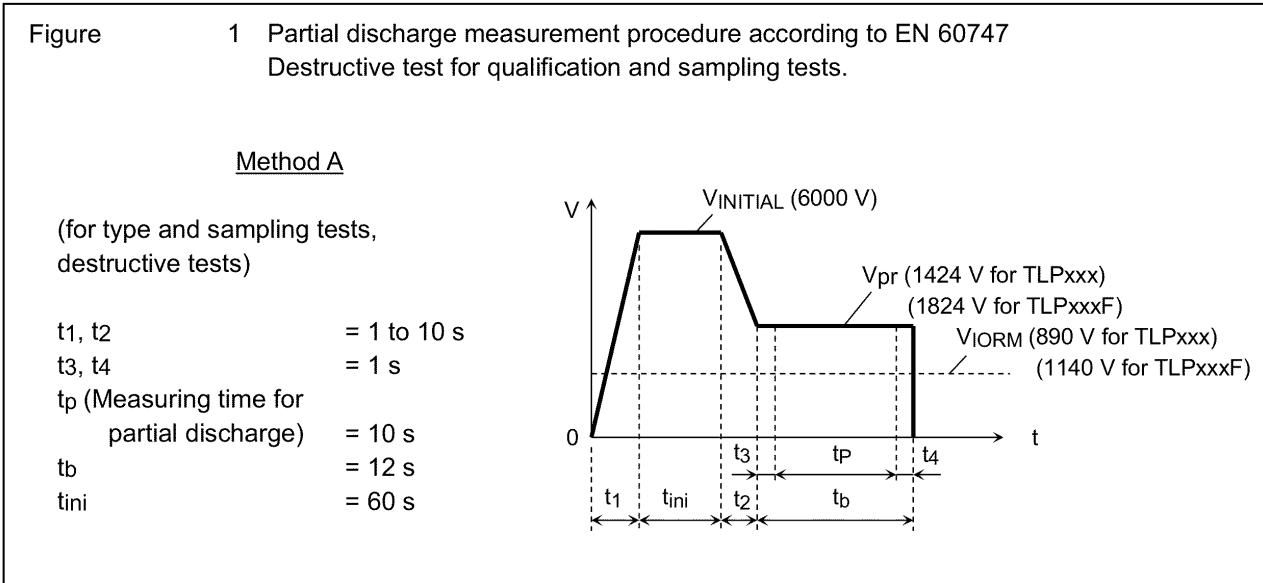

Fig. 20.5 Measurement Procedure

21. Ordering Information (Example of Item Name)

Item Name	Packaging (Note 1)	VDE Option	Packing (MOQ)
TLP3547(F)	TH		Magazine (50 pcs)
TLP3547(LF1,F)	LF1		Magazine (50 pcs)
TLP3547(LF5,F)	LF5		Magazine (50 pcs)
TLP3547(TP1,F)	LF1		Tape and reel (1500 pcs)
TLP3547(TP5,F)	LF5		Tape and reel (1500 pcs)
TLP3547F(F)	TH, Wide forming		Magazine (50 pcs)
TLP3547F(LF4,F)	LF4, Wide forming		Magazine (50 pcs)
TLP3547F(TP4,F)	LF4, Wide forming		Tape and reel (1000 pcs)
TLP3547(D4,F)	TH	EN 60747-5-5	Magazine (50 pcs)
TLP3547(D4,LF1,F)	LF1	EN 60747-5-5	Magazine (50 pcs)
TLP3547(D4,LF5,F)	LF5	EN 60747-5-5	Magazine (50 pcs)
TLP3547(D4,TP1,F)	LF1	EN 60747-5-5	Tape and reel (1500 pcs)
TLP3547(D4,TP5,F)	LF5	EN 60747-5-5	Tape and reel (1500 pcs)
TLP3547F(D4,F)	TH, Wide forming	EN 60747-5-5	Magazine (50 pcs)
TLP3547F(D4LF4,F)	LF4, Wide forming	EN 60747-5-5	Magazine (50 pcs)
TLP3547F(D4TP4,F)	LF4, Wide forming	EN 60747-5-5	Tape and reel (1000 pcs)

Note 1: TH: Through-hole, LF/TP: Lead forming for surface mount

Package Dimensions

Unit: mm

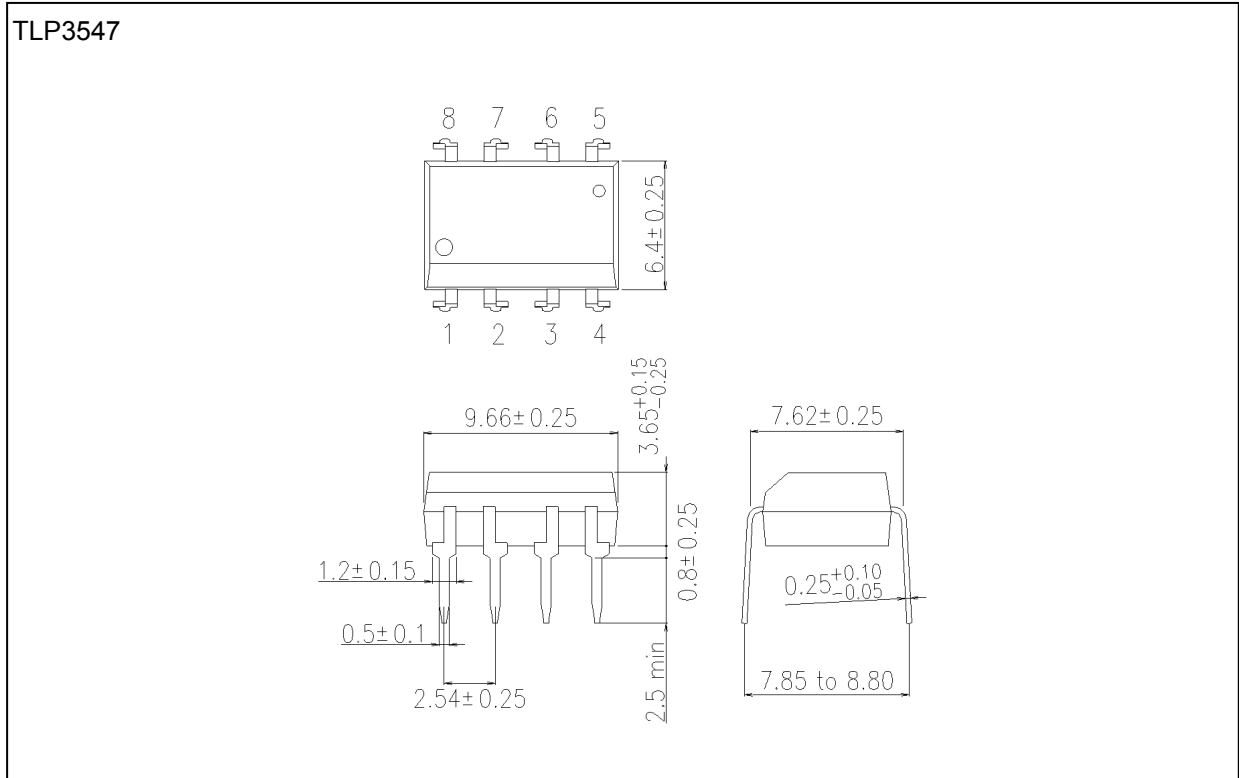

Weight: 0.54 g (typ.)

Package Name(s)
TOSHIBA: 11-10C4S

Package Dimensions

Unit: mm

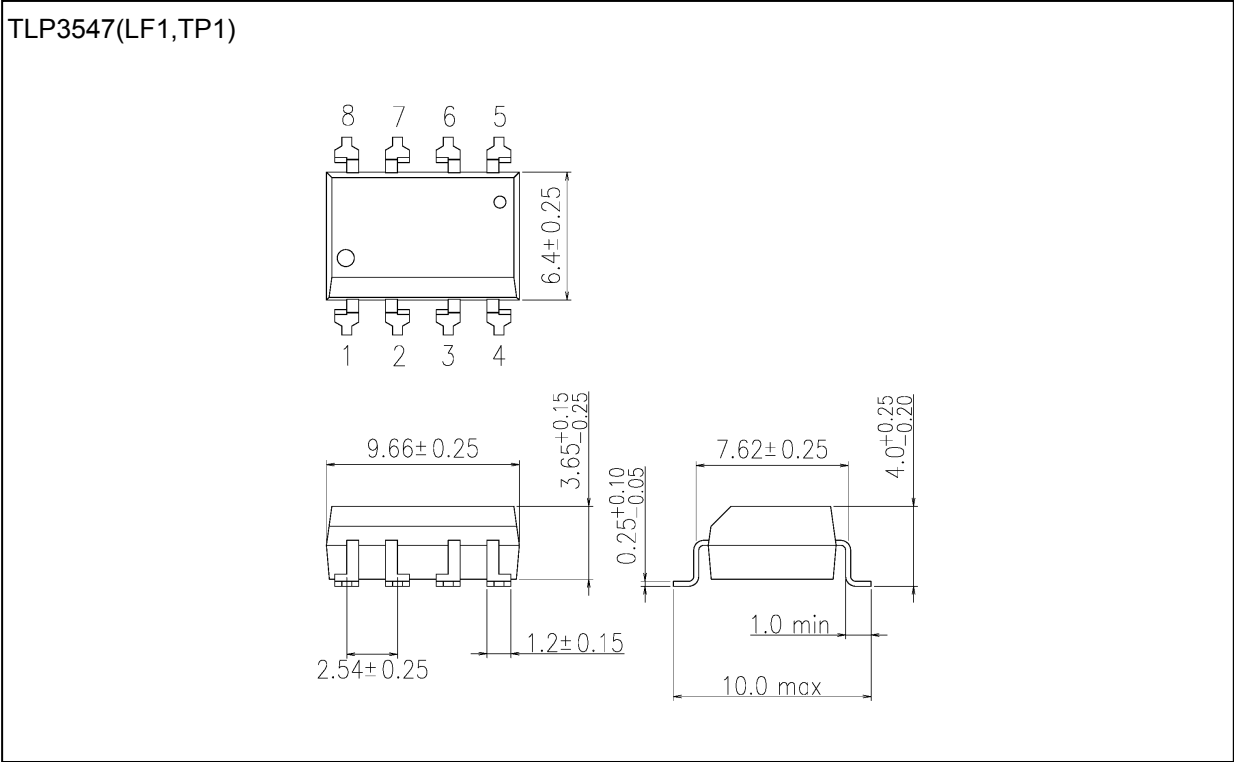

Weight: 0.53 g (typ.)

Package Name(s)
TOSHIBA: 11-10C401S

Package Dimensions

Unit: mm

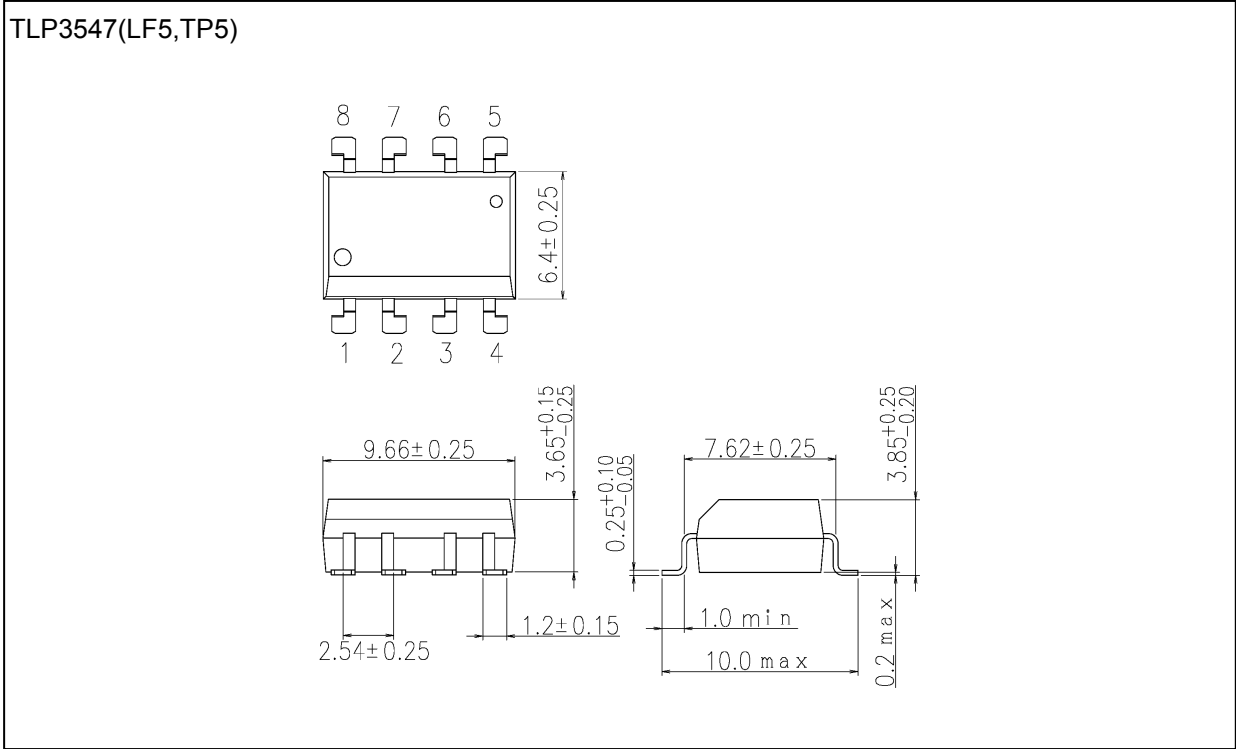

Weight: 0.53 g (typ.)

Package Name(s)
TOSHIBA: 11-10C405S

Package Dimensions

Unit: mm

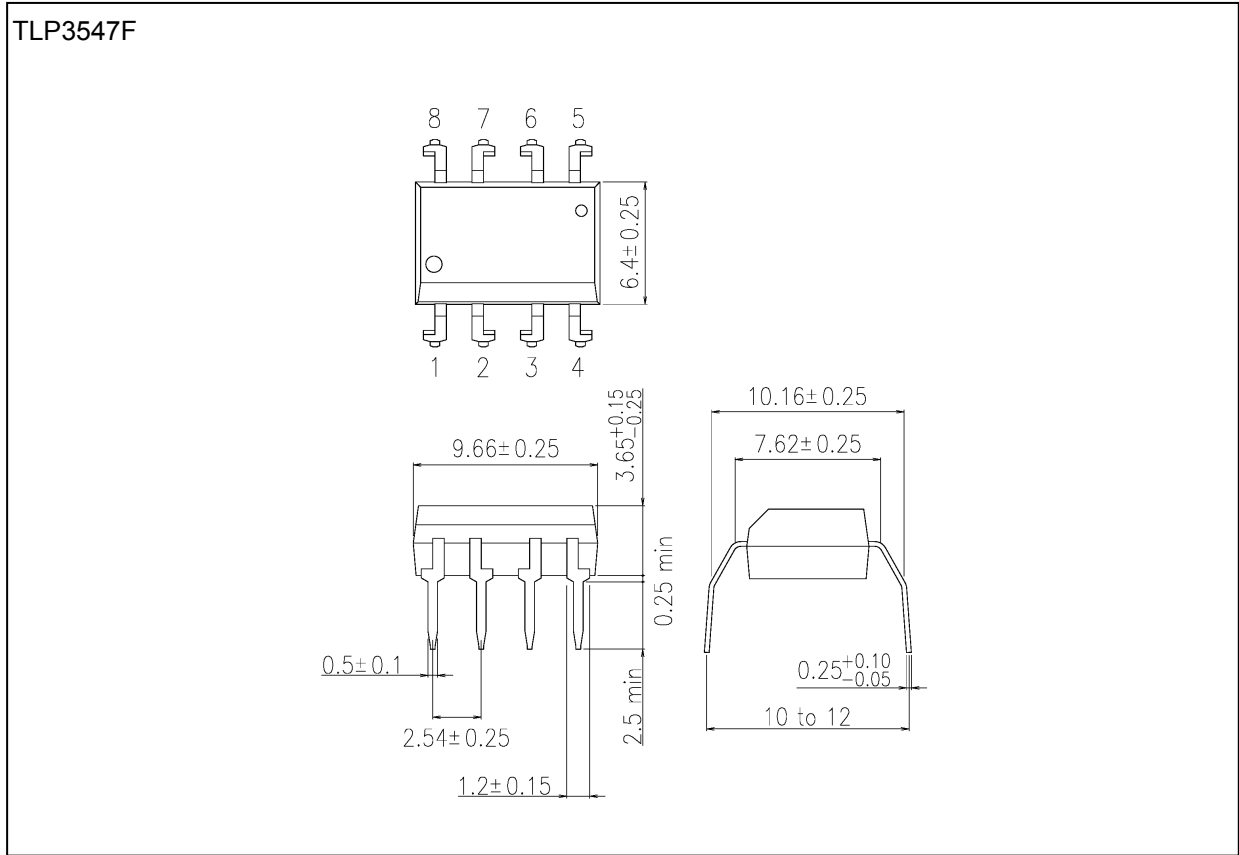

Weight: 0.54 g (typ.)

Package Name(s)
TOSHIBA: 11-10C402S

Package Dimensions

Unit: mm

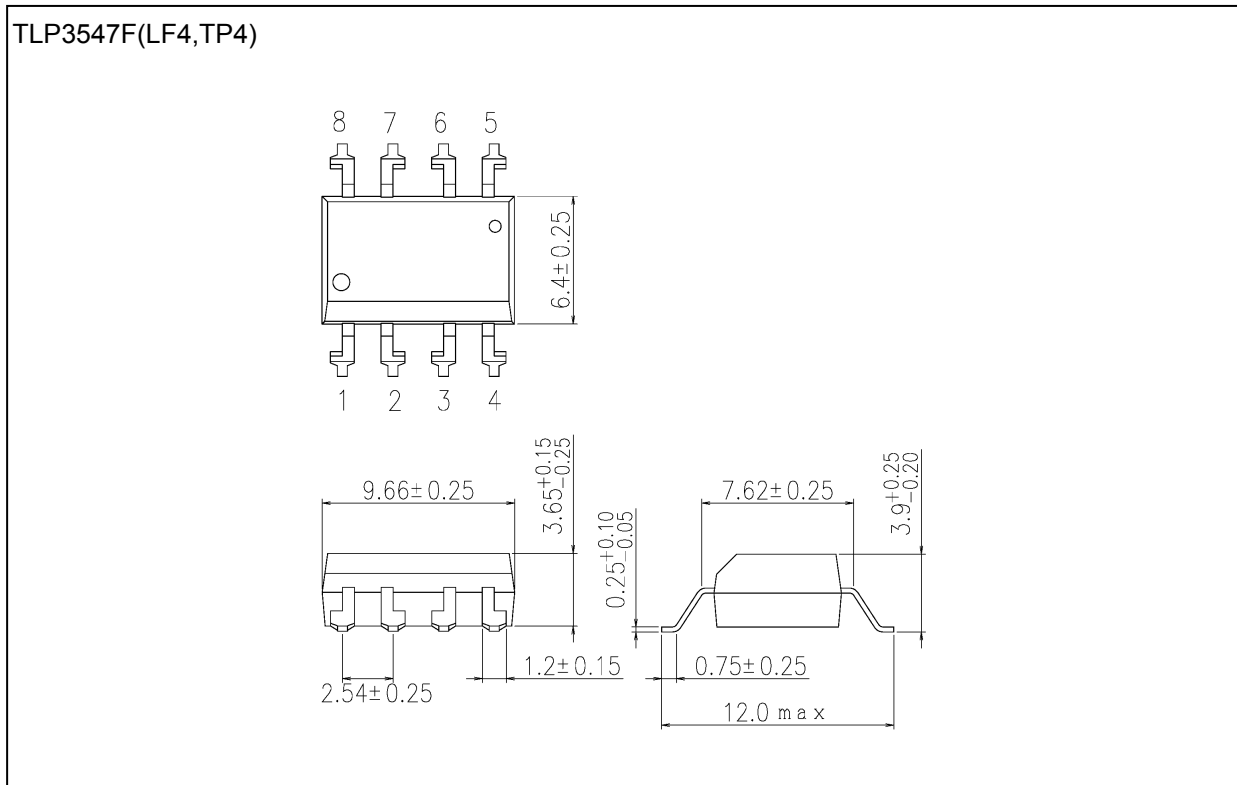

Weight: 0.53 g (typ.)

Package Name(s)
TOSHIBA: 11-10C404S

RESTRICTIONS ON PRODUCT USE

Toshiba Corporation and its subsidiaries and affiliates are collectively referred to as "TOSHIBA".

Hardware, software and systems described in this document are collectively referred to as "Product".

- TOSHIBA reserves the right to make changes to the information in this document and related Product without notice.
- This document and any information herein may not be reproduced without prior written permission from TOSHIBA. Even with TOSHIBA's written permission, reproduction is permissible only if reproduction is without alteration/omission.
- Though TOSHIBA works continually to improve Product's quality and reliability, Product can malfunction or fail. Customers are responsible for complying with safety standards and for providing adequate designs and safeguards for their hardware, software and systems which minimize risk and avoid situations in which a malfunction or failure of Product could cause loss of human life, bodily injury or damage to property, including data loss or corruption. Before customers use the Product, create designs including the Product, or incorporate the Product into their own applications, customers must also refer to and comply with (a) the latest versions of all relevant TOSHIBA information, including without limitation, this document, the specifications, the data sheets and application notes for Product and the precautions and conditions set forth in the "TOSHIBA Semiconductor Reliability Handbook" and (b) the instructions for the application with which the Product will be used with or for. Customers are solely responsible for all aspects of their own product design or applications, including but not limited to (a) determining the appropriateness of the use of this Product in such design or applications; (b) evaluating and determining the applicability of any information contained in this document, or in charts, diagrams, programs, algorithms, sample application circuits, or any other referenced documents; and (c) validating all operating parameters for such designs and applications.
TOSHIBA ASSUMES NO LIABILITY FOR CUSTOMERS' PRODUCT DESIGN OR APPLICATIONS.

- **PRODUCT IS NEITHER INTENDED NOR WARRANTED FOR USE IN EQUIPMENTS OR SYSTEMS THAT REQUIRE EXTRAORDINARILY HIGH LEVELS OF QUALITY AND/OR RELIABILITY, AND/OR A MALFUNCTION OR FAILURE OF WHICH MAY CAUSE LOSS OF HUMAN LIFE, BODILY INJURY, SERIOUS PROPERTY DAMAGE AND/OR SERIOUS PUBLIC IMPACT ("UNINTENDED USE").**

Except for specific applications as expressly stated in this document, Unintended Use includes, without limitation, equipment used in nuclear facilities, equipment used in the aerospace industry, lifesaving and/or life supporting medical equipment, equipment used for automobiles, trains, ships and other transportation, traffic signaling equipment, equipment used to control combustions or explosions, safety devices, elevators and escalators, and devices related to power plant.

IF YOU USE PRODUCT FOR UNINTENDED USE, TOSHIBA ASSUMES NO LIABILITY FOR PRODUCT.

For details, please contact your TOSHIBA sales representative or contact us via our website.

- Do not disassemble, analyze, reverse-engineer, alter, modify, translate or copy Product, whether in whole or in part.
- Product shall not be used for or incorporated into any products or systems whose manufacture, use, or sale is prohibited under any applicable laws or regulations.
- The information contained herein is presented only as guidance for Product use. No responsibility is assumed by TOSHIBA for any infringement of patents or any other intellectual property rights of third parties that may result from the use of Product. No license to any intellectual property right is granted by this document, whether express or implied, by estoppel or otherwise.
- **ABSENT A WRITTEN SIGNED AGREEMENT, EXCEPT AS PROVIDED IN THE RELEVANT TERMS AND CONDITIONS OF SALE FOR PRODUCT, AND TO THE MAXIMUM EXTENT ALLOWABLE BY LAW, TOSHIBA (1) ASSUMES NO LIABILITY WHATSOEVER, INCLUDING WITHOUT LIMITATION, INDIRECT, CONSEQUENTIAL, SPECIAL, OR INCIDENTAL DAMAGES OR LOSS, INCLUDING WITHOUT LIMITATION, LOSS OF PROFITS, LOSS OF OPPORTUNITIES, BUSINESS INTERRUPTION AND LOSS OF DATA, AND (2) DISCLAIMS ANY AND ALL EXPRESS OR IMPLIED WARRANTIES AND CONDITIONS RELATED TO SALE, USE OF PRODUCT, OR INFORMATION, INCLUDING WARRANTIES OR CONDITIONS OF MERCHANTABILITY, FITNESS FOR A PARTICULAR PURPOSE, ACCURACY OF INFORMATION, OR NONINFRINGEMENT.**
- GaAs (Gallium Arsenide) is used in Product. GaAs is harmful to humans if consumed or absorbed, whether in the form of dust or vapor. Handle with care and do not break, cut, crush, grind, dissolve chemically or otherwise expose GaAs in Product.
- Do not use or otherwise make available Product or related software or technology for any military purposes, including without limitation, for the design, development, use, stockpiling or manufacturing of nuclear, chemical, or biological weapons or missile technology products (mass destruction weapons). Product and related software and technology may be controlled under the applicable export laws and regulations including, without limitation, the Japanese Foreign Exchange and Foreign Trade Law and the U.S. Export Administration Regulations. Export and re-export of Product or related software or technology are strictly prohibited except in compliance with all applicable export laws and regulations.
- Please contact your TOSHIBA sales representative for details as to environmental matters such as the RoHS compatibility of Product. Please use Product in compliance with all applicable laws and regulations that regulate the inclusion or use of controlled substances, including without limitation, the EU RoHS Directive. **TOSHIBA ASSUMES NO LIABILITY FOR DAMAGES OR LOSSES OCCURRING AS A RESULT OF NONCOMPLIANCE WITH APPLICABLE LAWS AND REGULATIONS.**