

Application Note

TRM (TRM-B)

Arm and Keil are registered trademarks of Arm Limited (or its subsidiaries) in the US and/or elsewhere.

All other company names, product names, and service names mentioned herein may be trademarks of their respective companies.

Table of Contents

Table of Contents.....	2
1. Preface	3
2. Technical Term	3
3. Reference Document	3
4. Target Sample Program	4
5. Configuration Diagram	4
6. Sample Program:TRM	5
6.1. Outlines of Operation.....	5
6.2. Function to Use.....	5
6.3. Interrupt to Use	5
6.4. Configuration.....	5
6.5. Example of Terminal Emulator Output	6
6.5.1. Normal Operation	6
6.5.2. Case of Error Occurrence	6
7. Activity diagram.....	7
7.1. main	7
7.2. InitTRM.....	9
7.3. InitT32A_Sout	10
7.4. InitT32A_RefIn	11
7.5. application_initialize.....	13
7.6. MeasureWave.....	14
7.7. CalcDiff.....	14
7.8. CalcAdjVal.....	15
7.9. GetAdjustmentValue	16
7.10. IOSCAadjustment	17
7.11. StartCapture.....	18
7.12. GetCaptureData.....	19
7.13. StopCapture.....	20
7.14. Interrupt.....	21
8. Revision History	22
RESTRICTIONS ON PRODUCT USE	23

1. Preface

This application note describes sample software for the monitoring function of the built-in oscillator (fIHOSC) using the TRM driver.

This document helps the user check operation of a product under development and develop its program.

2. Technical Term

Term/Abbreviation	Definition
CG	Clock Control and Operation Mode
Timer	T32A:32-bit Timer Event Counter
TRM	Trimming circuit
UART	Universal Asynchronous Receiver Transmitter

3. Reference Document

Document	Notes
Data sheet	Refer to the data sheet of MCU to be used.
Reference manual	Refer to the reference manual of each IP to be used.
Application note MCU User Guide	Refer to the MCU user guide to be used.

4. Target Sample Program

Sample Program	Outline
TRM	Sample program of TRM function

5. Configuration Diagram

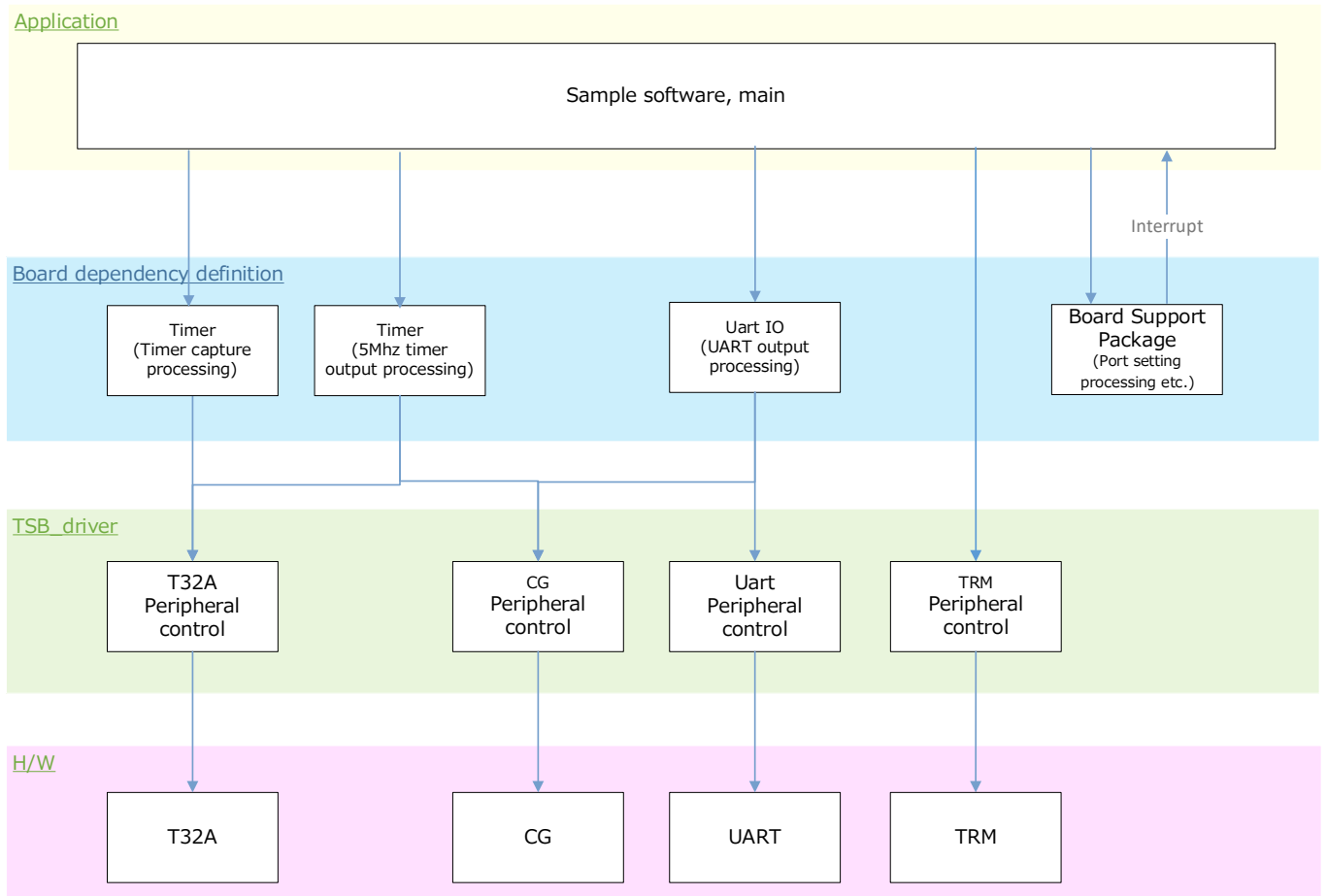

6. Sample Program:TRM

This is sample software that trims the built-in oscillation (fIHOSC) using the reference clock (low-speed oscillator (fs) or external reference clock (BSP_T32A_CAPT_1)).
The compile options to switch the reference clock.

6.1. Outlines of Operation

Pulse B is output from BSP_T32A_PPG_2. After that, set the trimming initial setting value.
Error measurement (waveform measurement) is performed until the number of trimmings is reached.

6.2. Function to Use

The functions to use are as follows:
For the Port assignment of each BSP channel, refer to the MCU user guide.

IP	Channel	Objective
T32A	BSP_T32A_CAPT_1	For pulse measurement. Used to measure the external reference clock
	*1 BSP_T32A_TRM_fs	*1 For pulse measurement. Used for measuring fs
	BSP_T32A_PPG_2	For pulse output. Used to check the error correction result
UART	BSP_UART_1	For terminal emulator communication (Outputs log)

*1 SBK-M4KN has no fs and is not used.

6.3. Interrupt to Use

Interrupt	Outlines
INTT32A01ACCAP1	T32A ch0 Timer_A Capture 1 For pulse measurement. Used for measuring external reference clock
INTT32A06A	T32A ch6 Timer_A For pulse measurement. Used for fs measurement
INTT32A03B	T32A ch3 Timer_B For pulse output. Used to check error correction results
INTUART0RX	UART ch0 Receive interrupt for terminal emulator
INTUART0TX	UART ch0 Transmission interrupt for terminal emulator
INTUART0ERR	UART ch0 Error interrupt for terminal emulator

6.4. Configuration

“main.c” configuration setting.

Configuration	Current Value	Description
Reference clock	PPG	Switch between slow oscillator (fs) and external reference clock
Pulse_A Cycle_A Duty_A	240Hz 50%	This is the input waveform of the external reference clock. It will be a low width specification * Specifications assuming a waveform created by transmitting UART2400bps characters and 0xF0 (1byte).
Pulse_B Cycle_B Duty_B	5MHz 50%	Output waveform for checking trimming result
Trimming times	10	-
Trimming default value	Minus maximum	The adjustment value will be shifted once for the trimming demo.

6.5. Example of Terminal Emulator Output

6.5.1. Normal Operation

```
please wait...
-----
|   start   |
-----
TRMOSC_RUN
<TRIMSET>:D
TRMOSC_RUN
<TRIMSET>:F
TRMOSC_DONE
<TRIMSET>:F
```

6.5.2. Case of Error Occurrence

Nothing.

7. Activity diagram

7.1. main

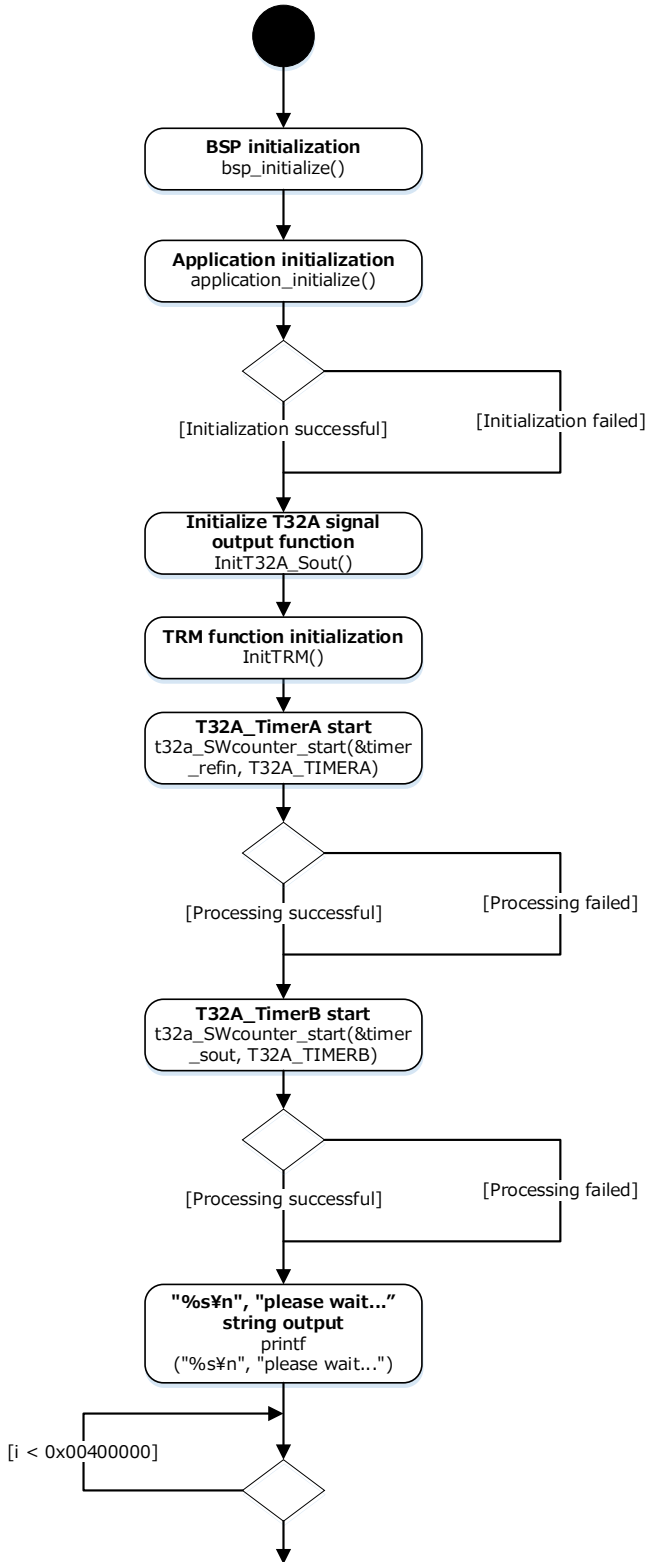

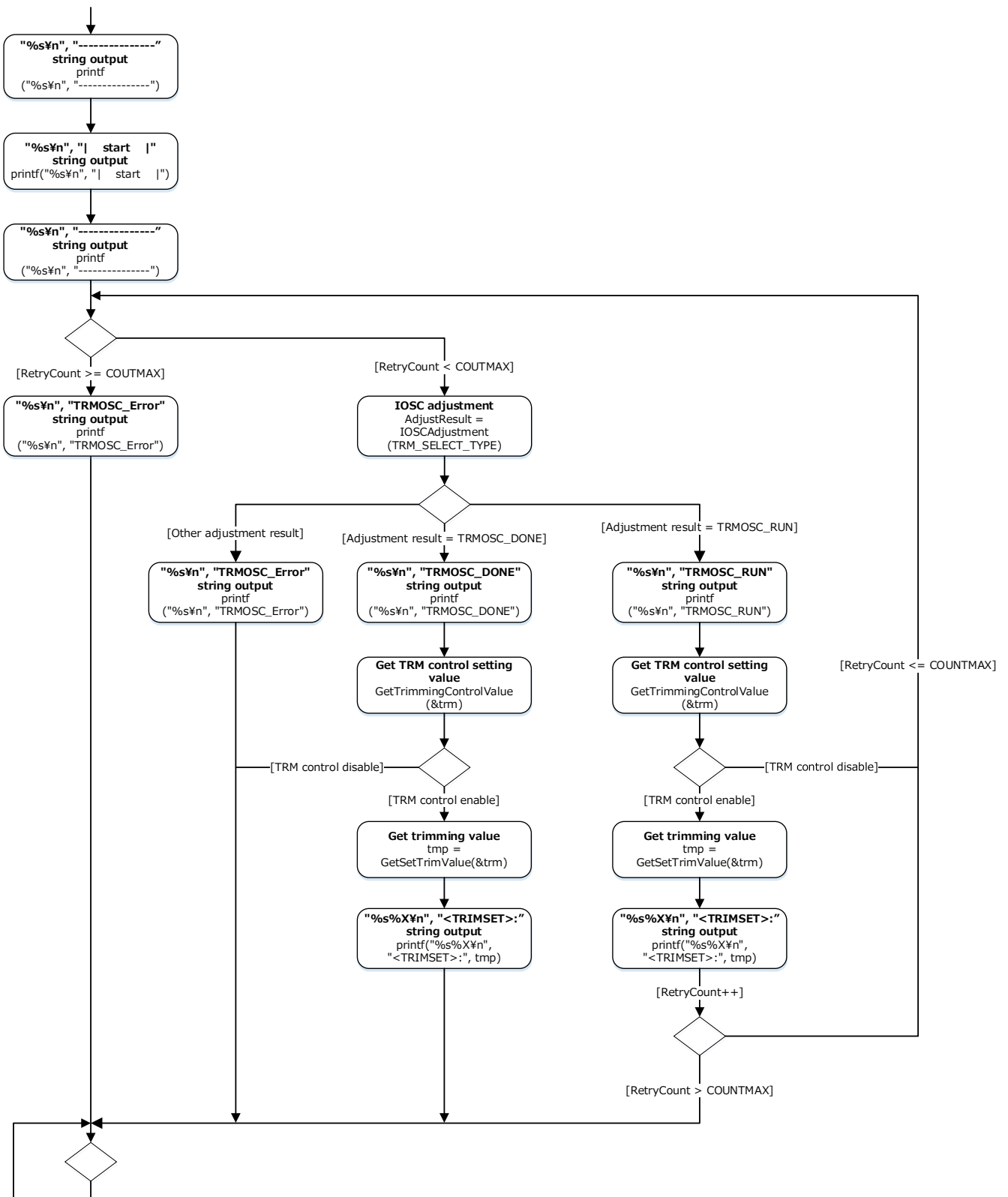

7.2. InitTRM

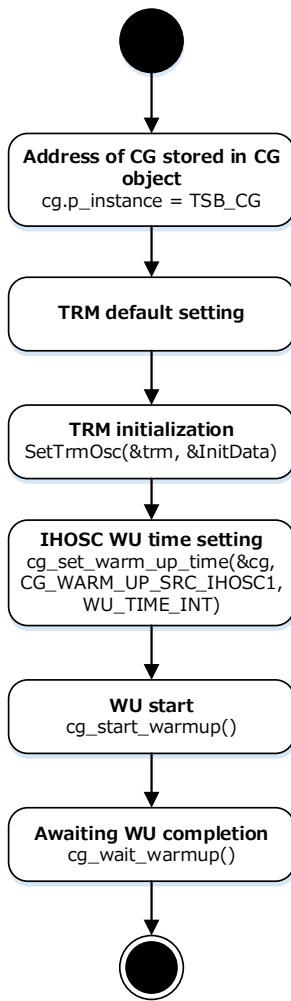

7.3. InitT32A_Sout

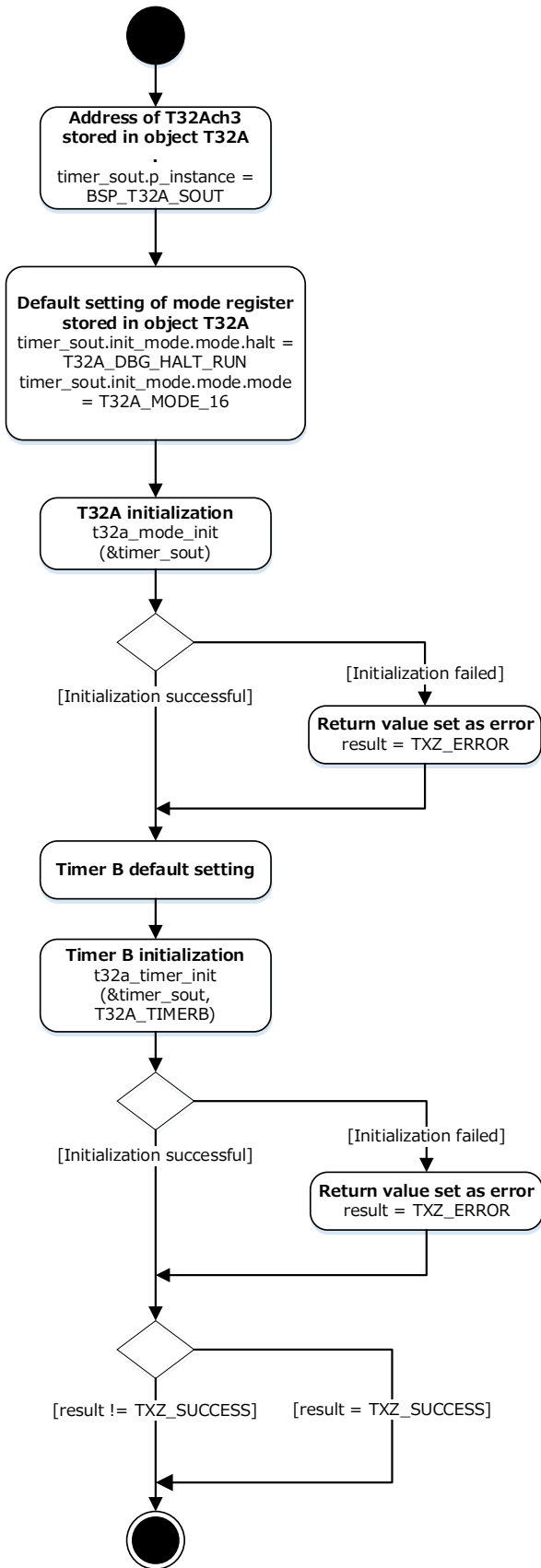

7.4. InitT32A_Refln

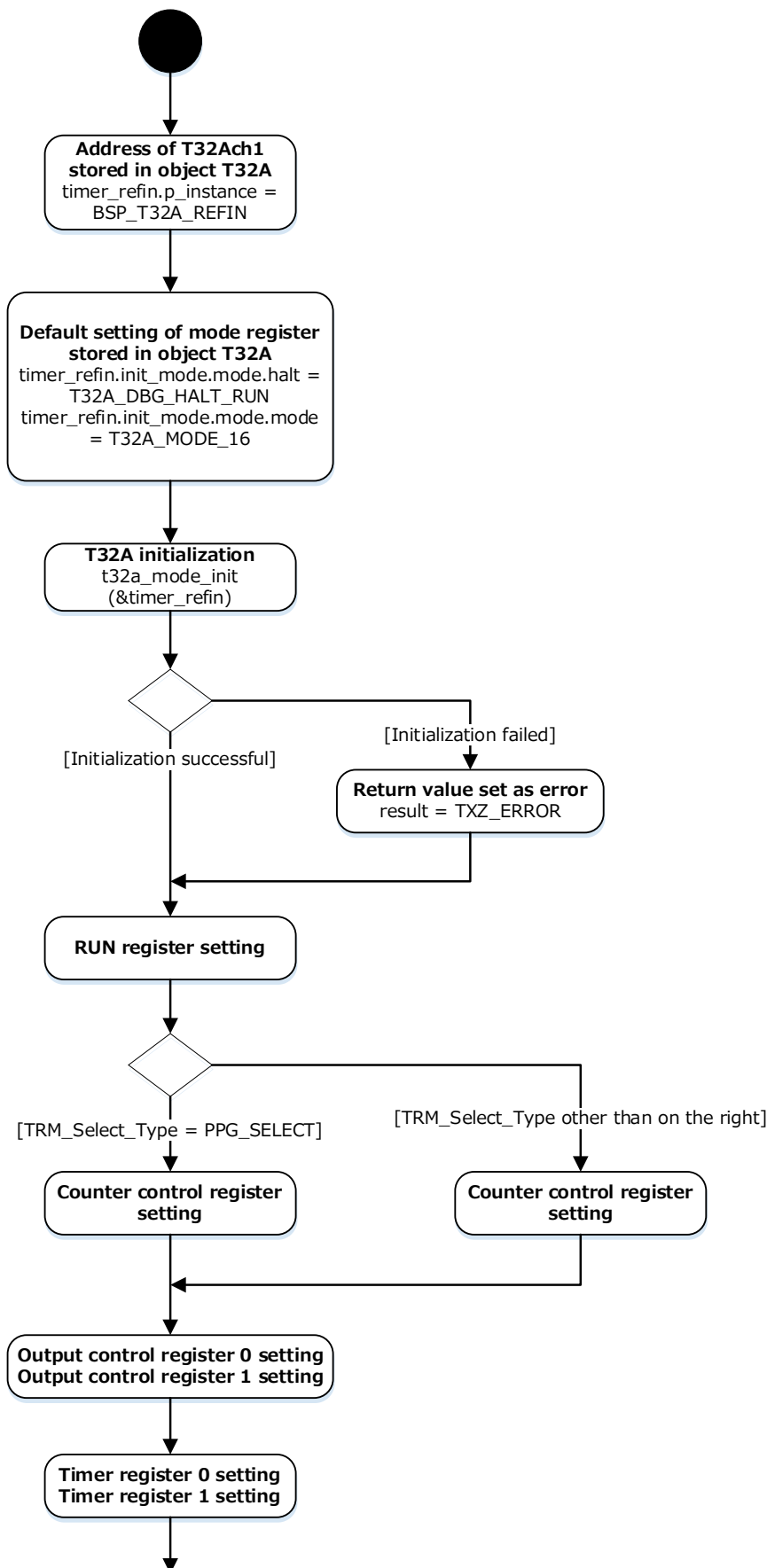

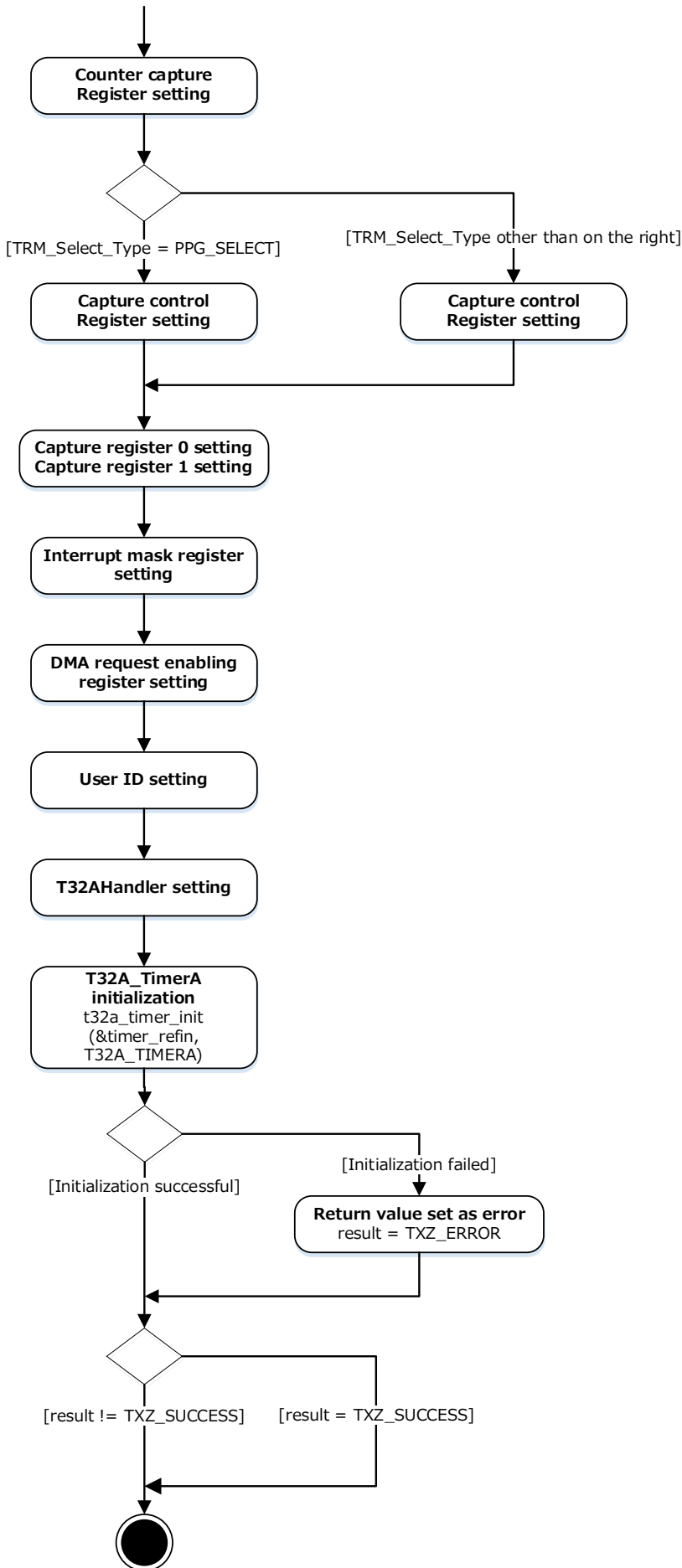

7.5. application_initialize

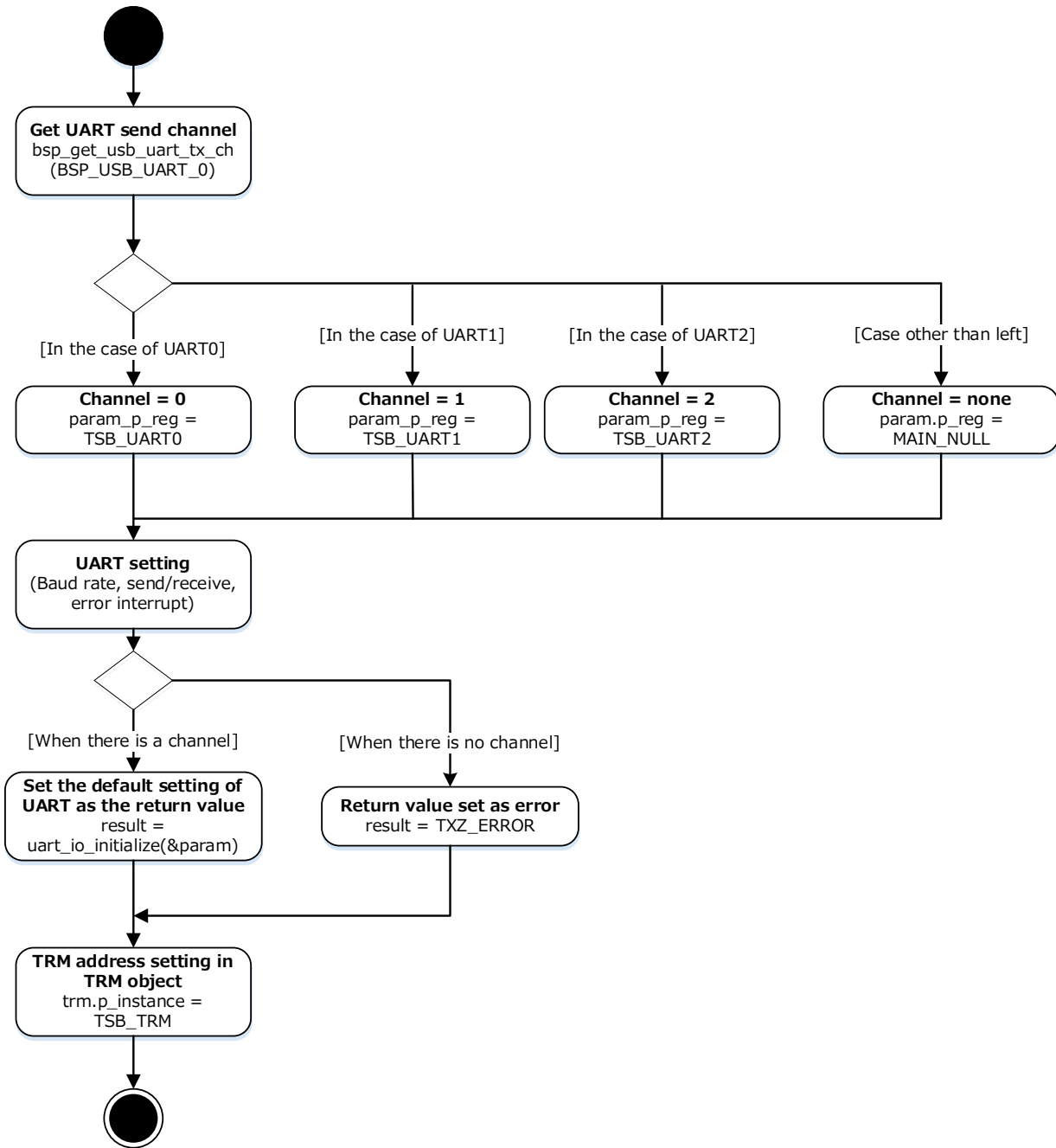

7.6. MeasureWave

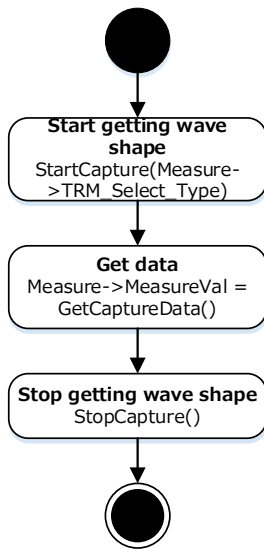

7.7. CalcDiff

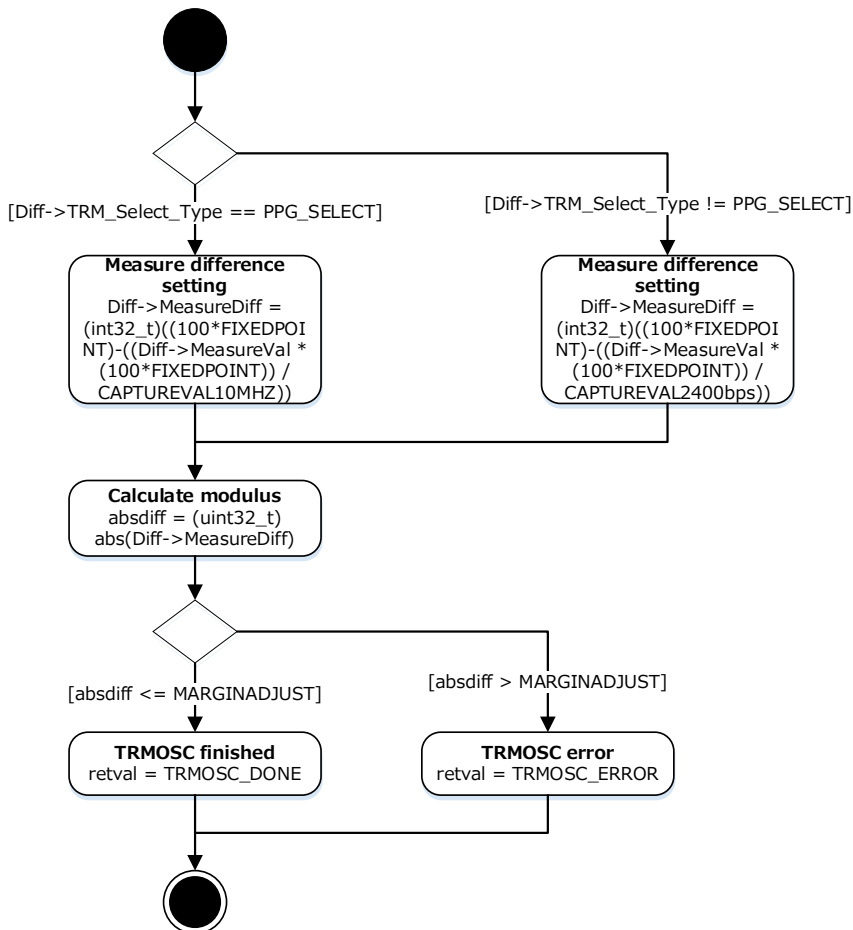

7.8. CalcAdjVal

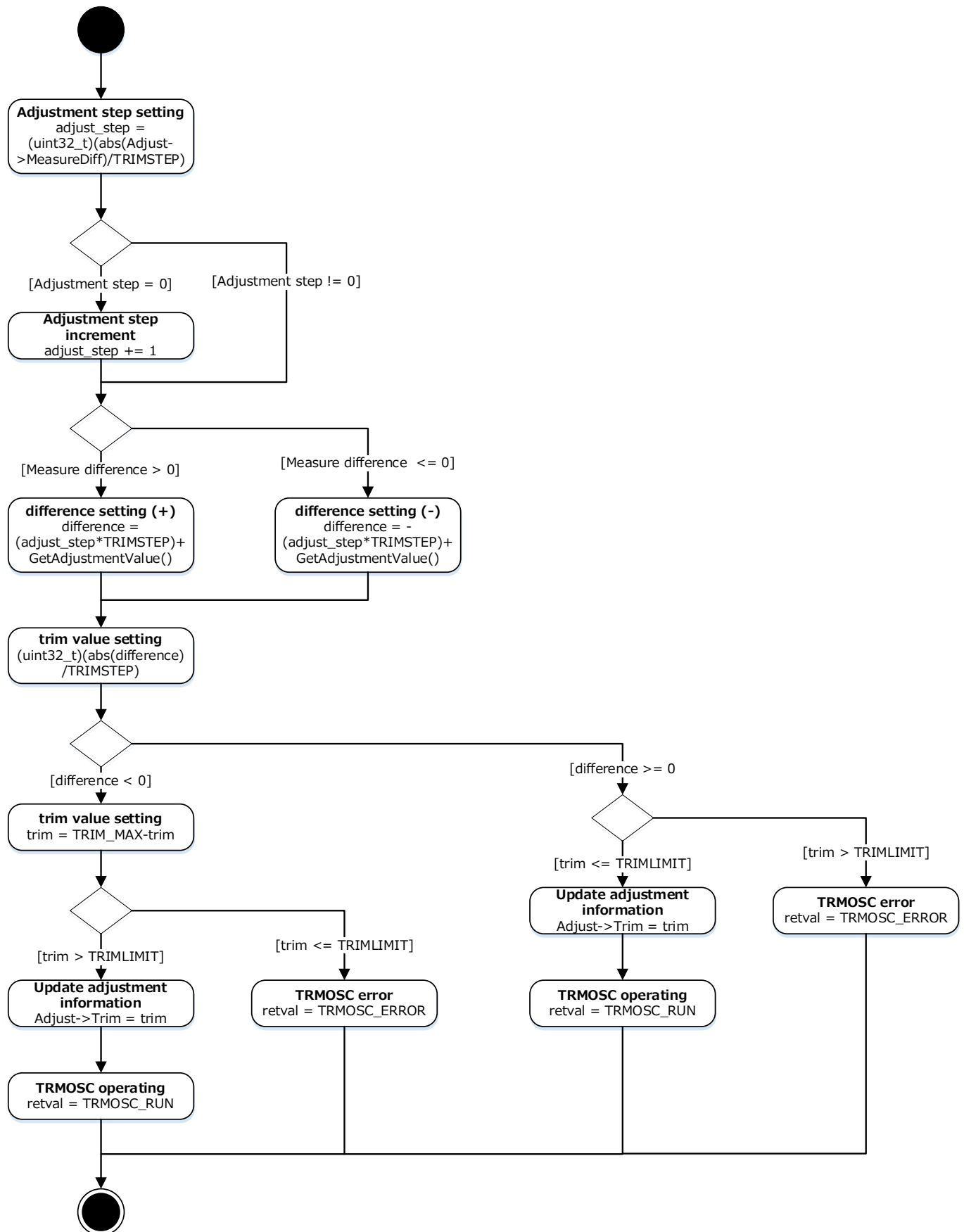

7.9. GetAdjustmentValue

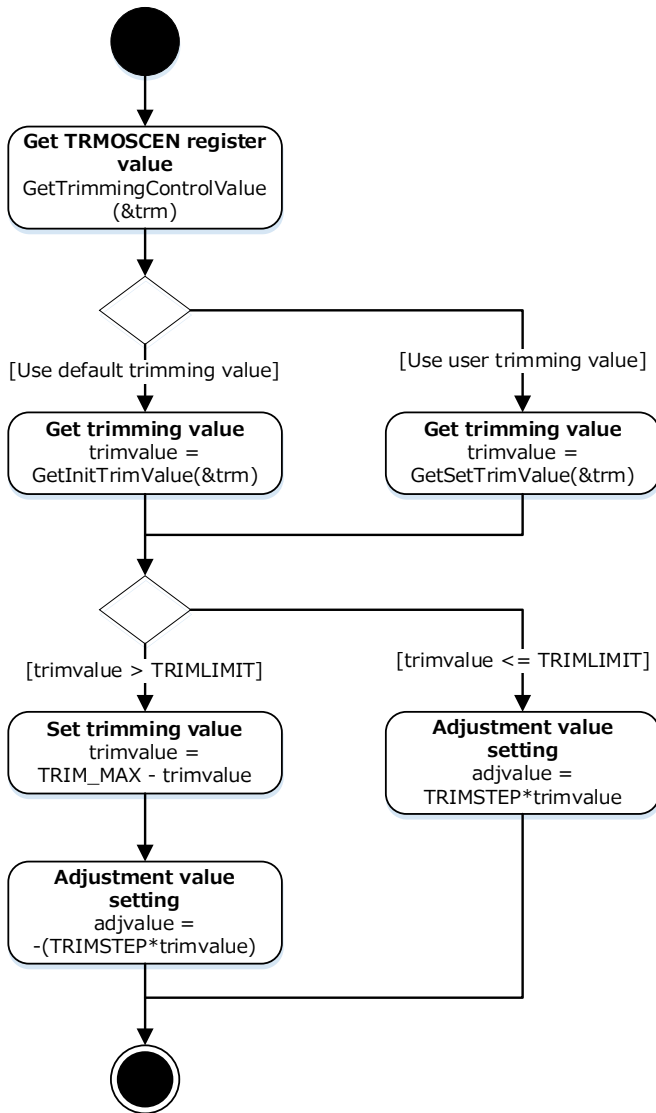

7.10. IOSCAAdjustment

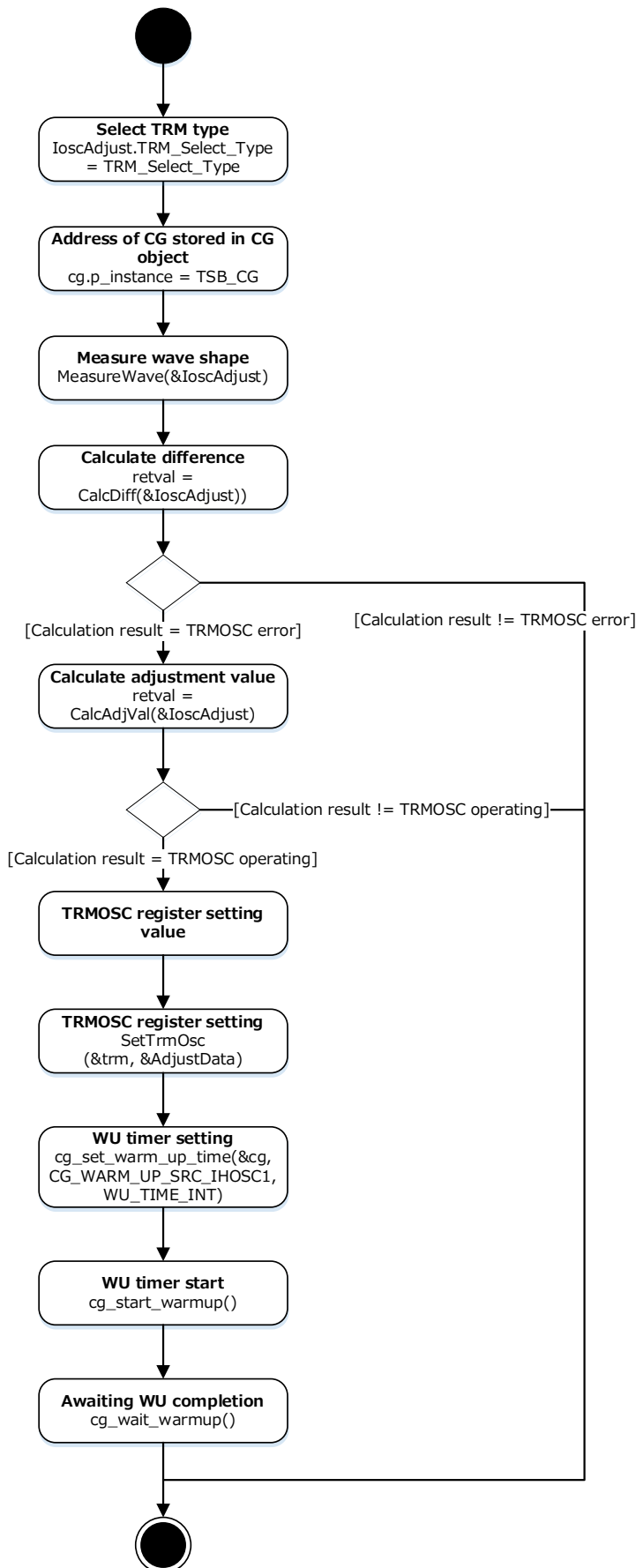

7.11. StartCapture

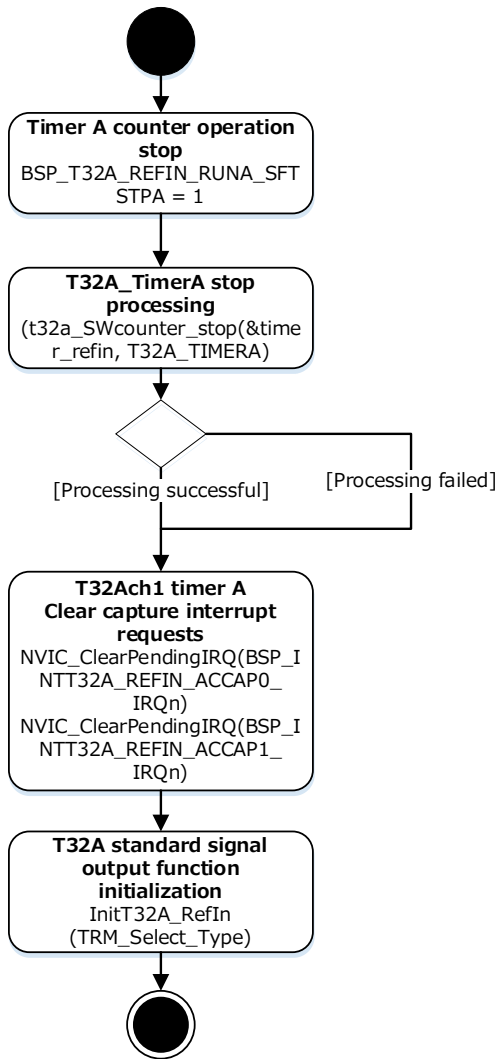

7.12. GetCaptureData

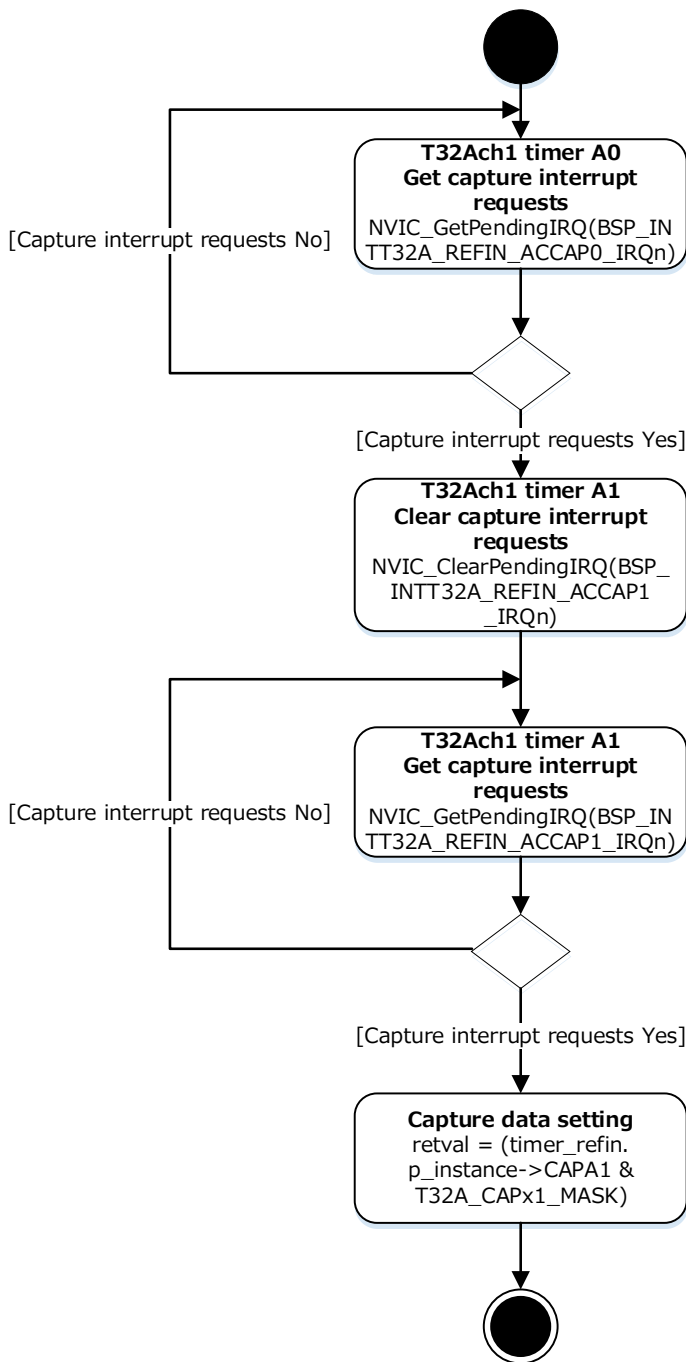

7.13. StopCapture

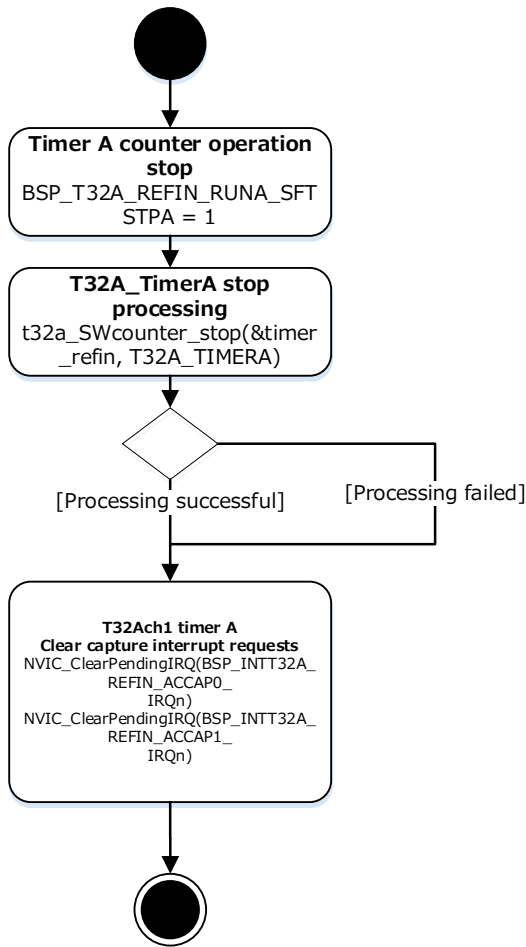

7.14. Interrupt

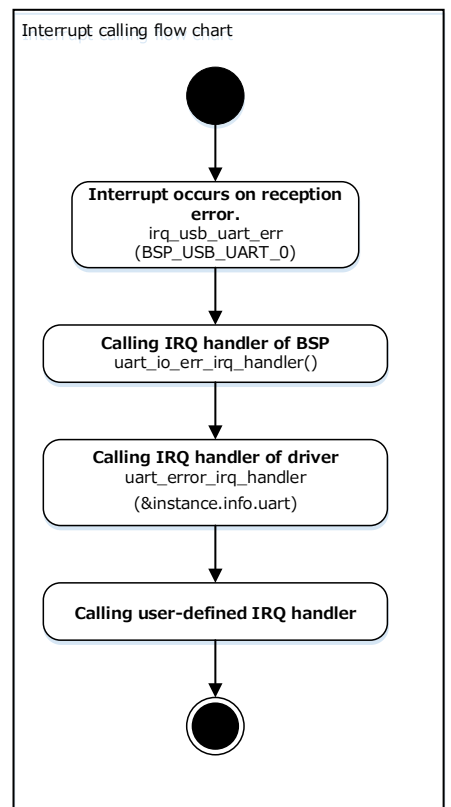
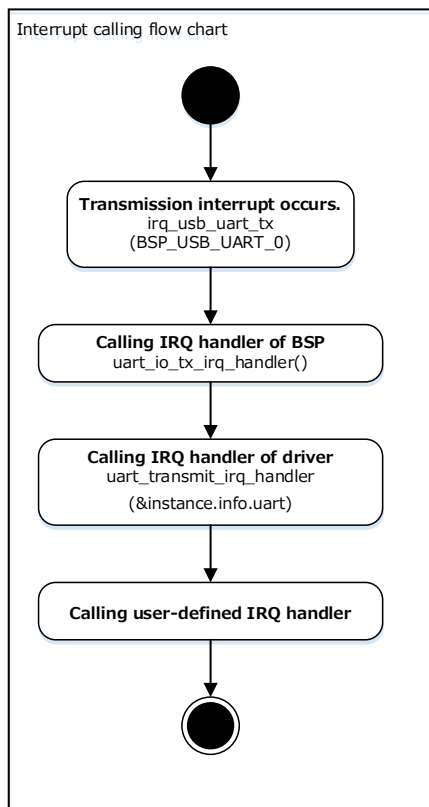
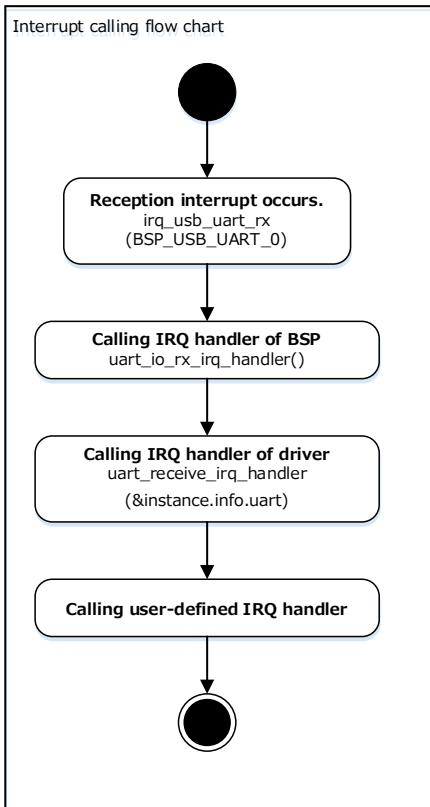

8. Revision History

Revision	Date	Description
1.0	2023-10-16	First release

RESTRICTIONS ON PRODUCT USE

Toshiba Corporation and its subsidiaries and affiliates are collectively referred to as "TOSHIBA". Hardware, software and systems described in this document are collectively referred to as "Product".

- TOSHIBA reserves the right to make changes to the information in this document and related Product without notice.
- This document and any information herein may not be reproduced without prior written permission from TOSHIBA. Even with TOSHIBA's written permission, reproduction is permissible only if reproduction is without alteration/omission.
- Though TOSHIBA works continually to improve Product's quality and reliability, Product can malfunction or fail. Customers are responsible for complying with safety standards and for providing adequate designs and safeguards for their hardware, software and systems which minimize risk and avoid situations in which a malfunction or failure of Product could cause loss of human life, bodily injury or damage to property, including data loss or corruption. Before customers use the Product, create designs including the Product, or incorporate the Product into their own applications, customers must also refer to and comply with (a) the latest versions of all relevant TOSHIBA information, including without limitation, this document, the specifications, the data sheets and application notes for Product and the precautions and conditions set forth in the "TOSHIBA Semiconductor Reliability Handbook" and (b) the instructions for the application with which the Product will be used with or for. Customers are solely responsible for all aspects of their own product design or applications, including but not limited to (a) determining the appropriateness of the use of this Product in such design or applications; (b) evaluating and determining the applicability of any information contained in this document, or in charts, diagrams, programs, algorithms, sample application circuits, or any other referenced documents; and (c) validating all operating parameters for such designs and applications. **TOSHIBA ASSUMES NO LIABILITY FOR CUSTOMERS' PRODUCT DESIGN OR APPLICATIONS.**
- **PRODUCT IS NEITHER INTENDED NOR WARRANTED FOR USE IN EQUIPMENTS OR SYSTEMS THAT REQUIRE EXTRAORDINARILY HIGH LEVELS OF QUALITY AND/OR RELIABILITY, AND/OR A MALFUNCTION OR FAILURE OF WHICH MAY CAUSE LOSS OF HUMAN LIFE, BODILY INJURY, SERIOUS PROPERTY DAMAGE AND/OR SERIOUS PUBLIC IMPACT ("UNINTENDED USE").** Except for specific applications as expressly stated in this document, Unintended Use includes, without limitation, equipment used in nuclear facilities, equipment used in the aerospace industry, lifesaving and/or life supporting medical equipment, equipment used for automobiles, trains, ships and other transportation, traffic signaling equipment, equipment used to control combustions or explosions, safety devices, elevators and escalators, and devices related to power plant. **IF YOU USE PRODUCT FOR UNINTENDED USE, TOSHIBA ASSUMES NO LIABILITY FOR PRODUCT.** For details, please contact your TOSHIBA sales representative or contact us via our website.
- Do not disassemble, analyze, reverse-engineer, alter, modify, translate or copy Product, whether in whole or in part.
- Product shall not be used for or incorporated into any products or systems whose manufacture, use, or sale is prohibited under any applicable laws or regulations.
- The information contained herein is presented only as guidance for Product use. No responsibility is assumed by TOSHIBA for any infringement of patents or any other intellectual property rights of third parties that may result from the use of Product. No license to any intellectual property right is granted by this document, whether express or implied, by estoppel or otherwise.
- **ABSENT A WRITTEN SIGNED AGREEMENT, EXCEPT AS PROVIDED IN THE RELEVANT TERMS AND CONDITIONS OF SALE FOR PRODUCT, AND TO THE MAXIMUM EXTENT ALLOWABLE BY LAW, TOSHIBA (1) ASSUMES NO LIABILITY WHATSOEVER, INCLUDING WITHOUT LIMITATION, INDIRECT, CONSEQUENTIAL, SPECIAL, OR INCIDENTAL DAMAGES OR LOSS, INCLUDING WITHOUT LIMITATION, LOSS OF PROFITS, LOSS OF OPPORTUNITIES, BUSINESS INTERRUPTION AND LOSS OF DATA, AND (2) DISCLAIMS ANY AND ALL EXPRESS OR IMPLIED WARRANTIES AND CONDITIONS RELATED TO SALE, USE OF PRODUCT, OR INFORMATION, INCLUDING WARRANTIES OR CONDITIONS OF MERCHANTABILITY, FITNESS FOR A PARTICULAR PURPOSE, ACCURACY OF INFORMATION, OR NONINFRINGEMENT.**
- Do not use or otherwise make available Product or related software or technology for any military purposes, including without limitation, for the design, development, use, stockpiling or manufacturing of nuclear, chemical, or biological weapons or missile technology products (mass destruction weapons). Product and related software and technology may be controlled under the applicable export laws and regulations including, without limitation, the Japanese Foreign Exchange and Foreign Trade Law and the U.S. Export Administration Regulations. Export and re-export of Product or related software or technology are strictly prohibited except in compliance with all applicable export laws and regulations.
- Please contact your TOSHIBA sales representative for details as to environmental matters such as the RoHS compatibility of Product. Please use Product in compliance with all applicable laws and regulations that regulate the inclusion or use of controlled substances, including without limitation, the EU RoHS Directive. **TOSHIBA ASSUMES NO LIABILITY FOR DAMAGES OR LOSSES OCCURRING AS A RESULT OF NONCOMPLIANCE WITH APPLICABLE LAWS AND REGULATIONS.**

Toshiba Electronic Devices & Storage Corporation

<https://toshiba.semicon-storage.com/>