

# TLP700

Industrial inverters  
 Inverter for air conditioners  
 IGBT/Power MOSFET gate drive

TLP700 consists of an infrared LED and an integrated photodetector. This unit is 6-lead SDIP package. The TLP700 is 50% smaller than the 8-pin DIP and meets the reinforced insulation class requirements of international safety standards. Therefore the mounting area can be reduced in equipment requiring safety standard certification. The TLP700 is suitable for gate driving circuits for IGBTs or power MOSFETs. In particular, the TLP700 is capable of "direct" gate driving of low-power IGBTs.

- Peak output current:  $\pm 2.0$  A (max)
- Guaranteed performance over temperature:  $-40$  to  $100^{\circ}\text{C}$
- Supply current: 2.0 mA (max)
- Power supply voltage: 15 to 30 V
- Threshold input current:  $I_{FLH} = 5$  mA (max)
- Switching time ( $t_{PLH} / t_{PHL}$ ): 500 ns (max)
- Common mode transient immunity:  $\pm 15$  kV/ $\mu\text{s}$  (min)
- Isolation voltage: 5000 Vrms (min)
- UL-recognized: UL 1577, File No.E67349
- cUL-recognized: CSA Component Acceptance Service No.5A  
File No.E67349
- VDE-approved: EN 60747-5-5, EN 62368-1 (Note 1)

Note 1 : When a VDE approved type is needed, please designate the **Option(D4)**.

**Truth Table**

Input	LED	M1	M2	Output
H	ON	ON	OFF	H
L	OFF	OFF	ON	L

Unit: mm

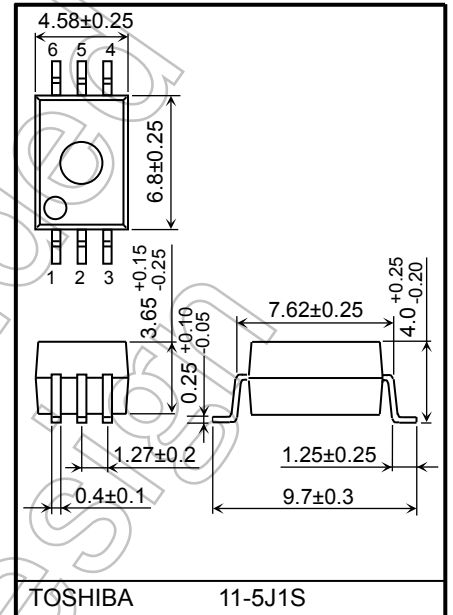

Weight: 0.26 g (typ.)

**Pin Configuration (Top View)**

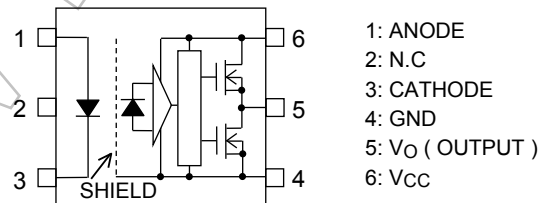

**Schematic**

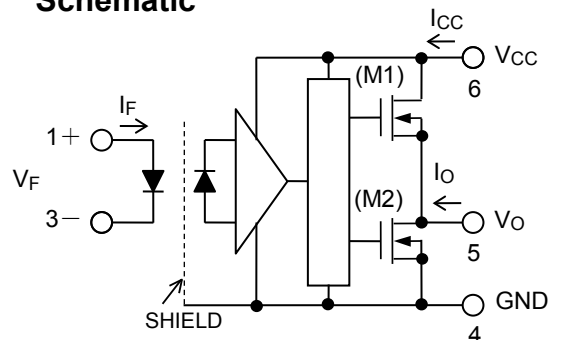

Note: A 0.1- $\mu\text{F}$  bypass capacitor must be connected between pins 6 and 4.

Start of commercial production  
 2007-08

## Absolute Maximum Ratings (Ta = 25 °C)

Characteristics		Symbol	Rating	Unit	
LED	Forward current	$I_F$	20	mA	
	Forward current derating (Ta ≥ 85°C)	$\Delta I_F / \Delta T_a$	-0.54	mA/°C	
	Peak transient forward current (Note 1)	$I_{FP}$	1	A	
	Reverse voltage	$V_R$	5	V	
	Diode power dissipation	$P_D$	40	mW	
	Diode power dissipation derating (Ta ≥ 85°C)	$\Delta P_D / \Delta T_a$	-1.0	mW/°C	
	Junction temperature	$T_j$	125	°C	
Detector	"H" peak output current	$T_a = -40$ to 100 °C (Note 2)	$I_{OPH}$	-2.0	A
	"L" peak output current		$I_{OPL}$	2.0	A
	Output voltage	$V_O$	35	V	
	Supply voltage	$V_{CC}$	35	V	
	Power dissipation	$P_C$	400	mW	
	Junction temperature	$T_j$	125	°C	
	Operating frequency (Note 3)	$f$	50	kHz	
Operating temperature range	$T_{opr}$	-40 to 100	°C		
Storage temperature range	$T_{stg}$	-55 to 125	°C		
Lead soldering temperature (10 s) (Note 4)	$T_{sol}$	260	°C		
Isolation voltage (AC, 60 s, R.H. ≤ 60 %) (Note 5)	$BV_S$	5000	Vrms		

Note: Using continuously under heavy loads (e.g. the application of high temperature/current/voltage and the significant change in temperature, etc.) may cause this product to decrease in the reliability significantly even if the operating conditions (i.e. operating temperature/current/voltage, etc.) are within the absolute maximum ratings.

Please design the appropriate reliability upon reviewing the Toshiba Semiconductor Reliability Handbook ("Handling Precautions"/"Derating Concept and Methods") and individual reliability data (i.e. reliability test report and estimated failure rate, etc).

Note: A ceramic capacitor (0.1 μF) should be connected from pin 6 to pin 4 to stabilize the operation of the high gain linear amplifier. Failure to provide the bypassing may impair the switching property. The total lead length between capacitor and coupler should not exceed 1 cm.

Note 1: Pulse width  $P_W \leq 1 \mu s$ , 300 pps

Note 2: Exponential waveform pulse width  $P_W \leq 0.3 \mu s$ ,  $f \leq 15$  kHz

Note 3: Exponential waveform  $I_{OPH} \geq -1.5$  A ( $\leq 0.3 \mu s$ ),  $I_{OPL} \leq +1.5$  A ( $\leq 0.3 \mu s$ ),  $T_a = 100$  °C

Note 4: For the effective lead soldering area

Note 5: Device considered a two-terminal device: pins 1, 2 and 3 paired with pins 4, 5 and 6 respectively.

## Recommended Operating Conditions

Characteristics	Symbol	Min	Typ.	Max	Unit
Input current, ON (Note 1)	$I_F$ (ON)	7.5	—	10	mA
Input voltage, OFF	$V_F$ (OFF)	0	—	0.8	V
Supply voltage (Note 2)(Note 3)	$V_{CC}$	15	—	30	V
Peak output current	$I_{OPH} / I_{OPL}$	—	—	±1.5	A
Operating temperature	$T_{opr}$	-40	—	100	°C

Note: Recommended operating conditions are given as a design guideline to obtain expected performance of the device. Additionally, each item is an independent guideline respectively. In developing designs using this product, please confirm specified characteristics shown in this document.

Note 1: Input signal rise time (fall time)  $\leq 0.5 \mu s$ .

Note 2: This item denotes operating ranges, not meaning of recommended operating conditions.

Note 3: If the  $V_{CC}$  rise slope is sharp, an internal circuit might not operate with stability. Please design the  $V_{CC}$  rise slope under 3.0 V/μs.

### Electrical Characteristics (Ta = -40 to 100 °C, unless otherwise specified)

Characteristics		Symbol	Test Circuit	Test Condition	Min	Typ.	Max	Unit	
Forward voltage		V <sub>F</sub>	—	I <sub>F</sub> = 10 mA, Ta = 25 °C	—	1.57	1.75	V	
Temperature coefficient of forward voltage		ΔV <sub>F</sub> /ΔTa	—	I <sub>F</sub> = 10 mA	—	-1.8	—	mV/°C	
Input reverse current		I <sub>R</sub>	—	V <sub>R</sub> = 5 V, Ta = 25 °C	—	—	10	μA	
Input capacitance		C <sub>T</sub>	—	V = 0 V, f = 1 MHz, Ta = 25 °C	—	100	—	pF	
Output current (Note 1)	“H” Level	I <sub>OPH1</sub>	1	V <sub>CC</sub> = 15 V I <sub>F</sub> = 5 mA	V <sub>6-5</sub> = 3.5 V	—	-1.4	-1.0	A
		I <sub>OPH2</sub>			V <sub>6-5</sub> = 7 V	—	—	-1.5	
	“L” Level	I <sub>OPL1</sub>	2	V <sub>CC</sub> = 15 V I <sub>F</sub> = 0 mA	V <sub>5-4</sub> = 2.5 V	1.0	1.4	—	
		I <sub>OPL2</sub>			V <sub>5-4</sub> = 7 V	1.5	—	—	
Output voltage	“H” Level	V <sub>OH</sub>	3	V <sub>CC1</sub> =+15V, V <sub>EE1</sub> =-15V R <sub>L</sub> = 200Ω, I <sub>F</sub> = 5 mA	11	13.7	—	V	
	“L” Level	V <sub>OL</sub>	4	V <sub>CC1</sub> =+15V, V <sub>EE1</sub> =-15V R <sub>L</sub> = 200Ω, V <sub>F</sub> = 0.8 V	—	-14.9	-12.5		
Supply current	“H” Level	I <sub>CCH</sub>	5	V <sub>CC</sub> = 30 V V <sub>O</sub> =Open	I <sub>F</sub> = 10 mA	—	1.3	2.0	mA
	“L” Level	I <sub>CCL</sub>	6		I <sub>F</sub> = 0 mA	—	1.3	2.0	
Threshold input current		L → H	I <sub>FLH</sub>	—	V <sub>CC</sub> = 15 V, V <sub>O</sub> > 1 V	—	1.8	5	mA
Threshold input voltage		H → L	V <sub>FHL</sub>	—	V <sub>CC</sub> = 15 V, V <sub>O</sub> < 1 V	0.8	—	—	V
Supply voltage		V <sub>CC</sub>	—	—	15	—	30	V	
UVLO thresh hold		V <sub>UVLO+</sub>	—	V <sub>O</sub> > 2.5V, I <sub>F</sub> = 5 mA	11.0	12.5	13.5	V	
		V <sub>UVLO-</sub>	—	V <sub>O</sub> < 2.5V, I <sub>F</sub> = 5 mA	9.5	11.0	12.0	V	
UVLO hysteresis		V <sub>UVLOHYS</sub>	—	—	—	1.5	—	V	

Note: All typical values are at Ta = 25 °C

Note: This product is more sensitive than conventional products to electrostatic discharge (ESD) owing to its low power consumption design. It is therefore all the more necessary to observe general precautions regarding ESD when handling this component.

Note 1: Duration of I<sub>O</sub> time ≤ 50 μs, 1 pulse

### Isolation Characteristics (Ta = 25 °C)

Characteristic	Symbol	Test Condition	Min	Typ.	Max	Unit
Capacitance input to output	C <sub>S</sub>	V <sub>S</sub> = 0 V, f = 1 MHz	—	1.0	—	pF
Isolation resistance	R <sub>S</sub>	R.H. ≤ 60 %, V <sub>S</sub> = 500 V	10 <sup>12</sup>	10 <sup>14</sup>	—	Ω
Isolation voltage	BV <sub>S</sub>	AC, 60 s	5000	—	—	V <sub>rms</sub>

Note: Device considered a two-terminal device: pins 1, 2 and 3 paired with pins 4, 5 and 6 respectively.

### Switching Characteristics (Ta = -40 to 100 °C, unless otherwise specified)

Characteristics	Symbol	Test Circuit	Test Condition	Min	Typ.	Max	Unit	
Propagation delay time	L → H	7	V <sub>CC</sub> = 30 V R <sub>g</sub> = 20 Ω C <sub>g</sub> = 10 nF	I <sub>F</sub> = 0 → 5 mA	50	—	500	ns
	H → L			I <sub>F</sub> = 5 → 0 mA	50	—	500	
Output rise time (10-90 %)	t <sub>r</sub>			I <sub>F</sub> = 0 → 5 mA	—	50	—	
Output fall time (90-10 %)	t <sub>f</sub>			I <sub>F</sub> = 5 → 0 mA	—	50	—	
Switching time dispersion between ON and OFF	t <sub>PHL</sub> - t <sub>PLH</sub>			I <sub>F</sub> = 0 ↔ 5 mA	—	—	250	
Common mode transient immunity at HIGH level output	CM <sub>H</sub>			8	V <sub>CM</sub> = 1000 V <sub>p-p</sub> Ta = 25 °C V <sub>CC</sub> = 30 V	I <sub>F</sub> = 5 mA V <sub>O(min)</sub> = 26 V	-15	
Common mode transient immunity at LOW level output	CM <sub>L</sub>	I <sub>F</sub> = 0 mA V <sub>O(max)</sub> = 1 V	15			—	—	

Note: All typical values are at Ta = 25 °C.

**Test Circuit 1: I<sub>OPH</sub>**

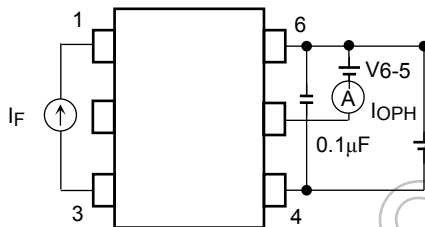

**Test Circuit 2: I<sub>OPL</sub>**

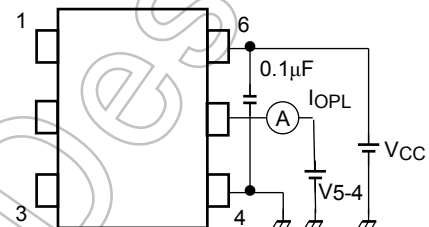

**Test Circuit 3: V<sub>OH</sub>**

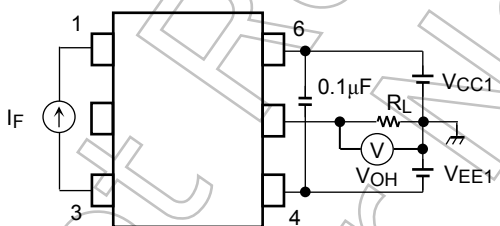

**Test Circuit 4: V<sub>OL</sub>**

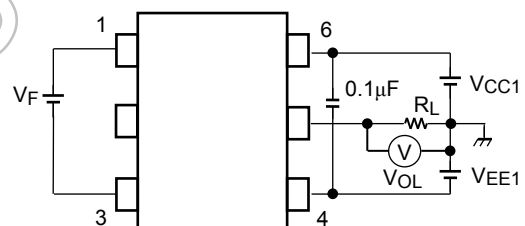

**Test Circuit 5: I<sub>CCH</sub>**

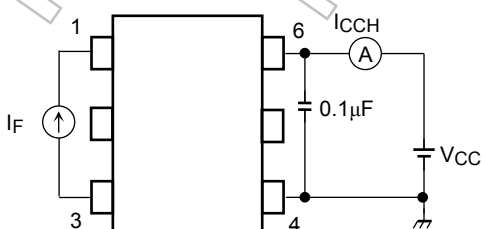

**Test Circuit 6: I<sub>CCL</sub>**

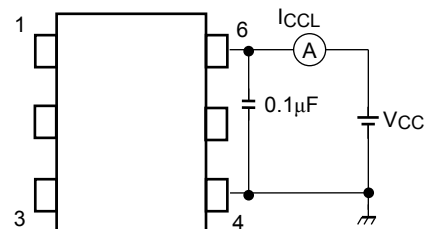

## Test Circuit 7: $t_{pLH}$ , $t_{pHL}$ , $t_r$ , $t_f$ , | $t_{pHL}-t_{pLH}$ |

( $f=25\text{kHz}$ ,  $\text{duty}=50\%$ , less than  $t_r=t_f=5\text{ns}$ )

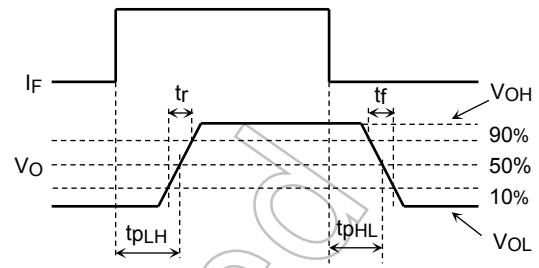
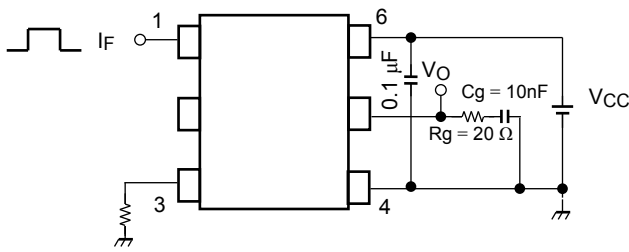

## Test Circuit 8: CMH, CML

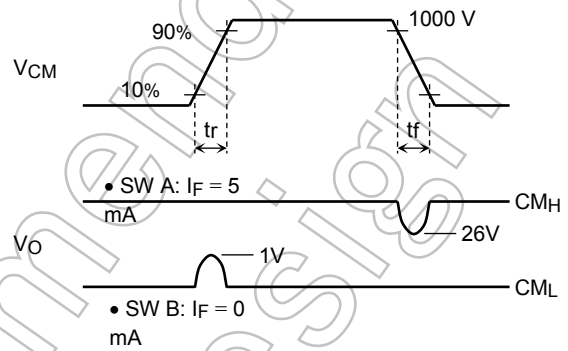
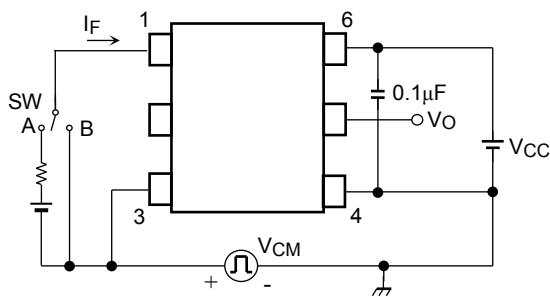

$$CM_H = \frac{800 \text{ V}}{t_f (\mu\text{s})}$$

$$CML = \frac{800 \text{ V}}{t_r (\mu\text{s})}$$

Note: CML (CMH) is the maximum rate of rise (fall) of the common mode voltage that can be sustained with the output voltage in the LOW (HIGH) state.

Not Recommended for New

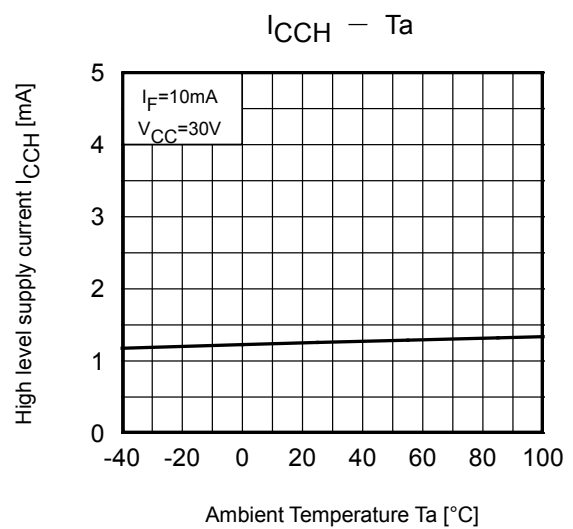
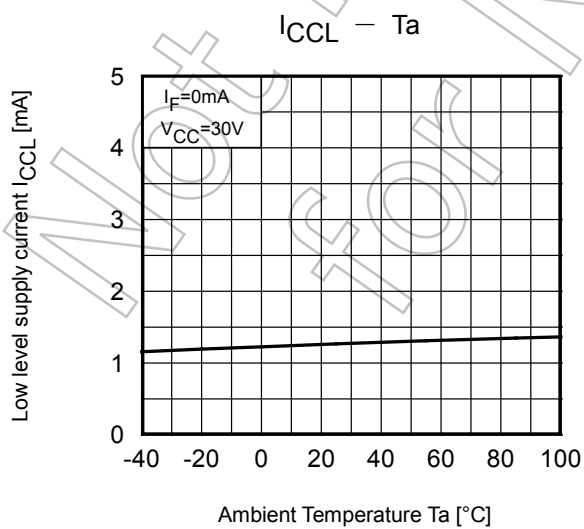
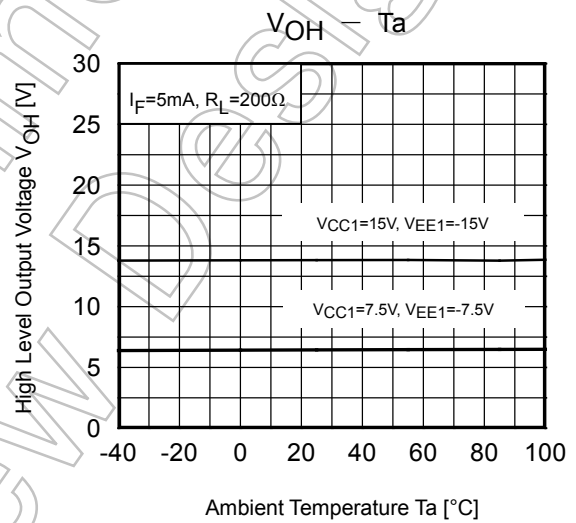
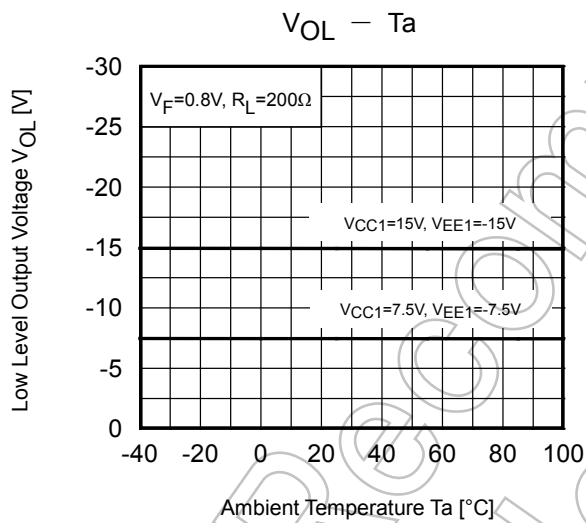
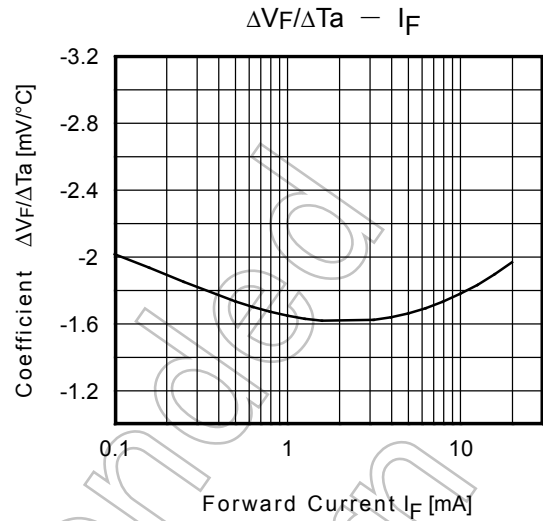
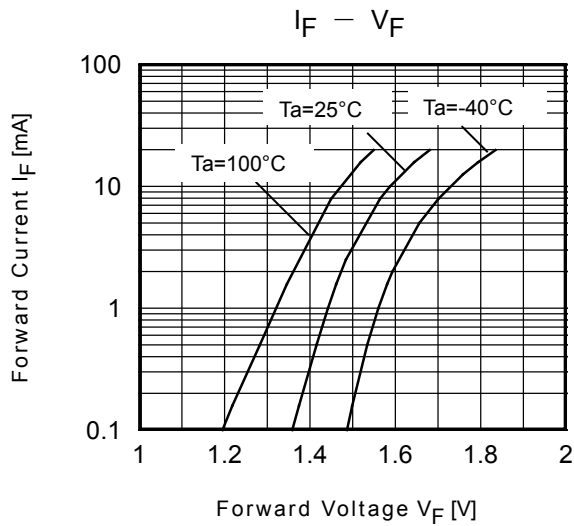

NOTE: The above characteristics curves are presented for reference only and not guaranteed by production test, unless otherwise noted.

tpHL, tpLH - Ta

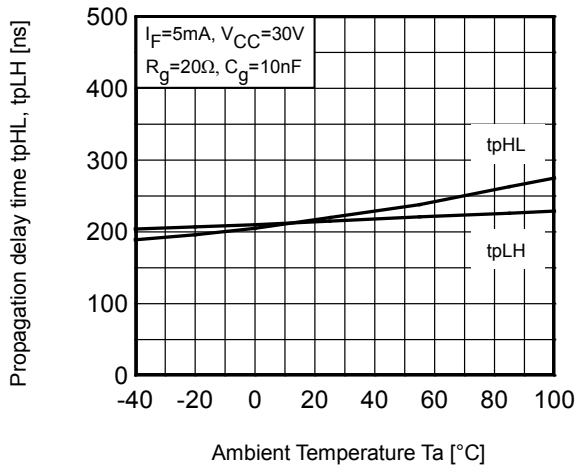

tpHL, tpLH - VCC

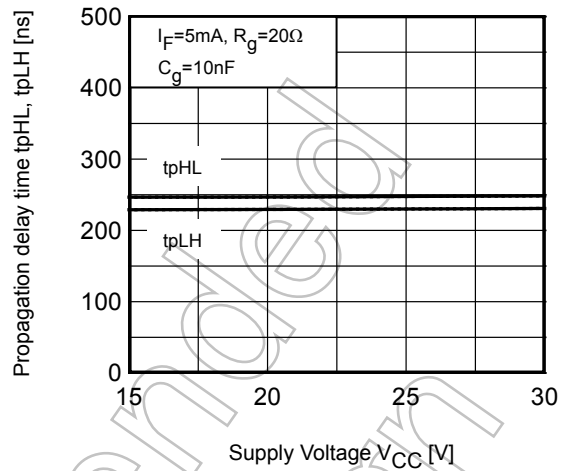

tpHL, tpLH - IF

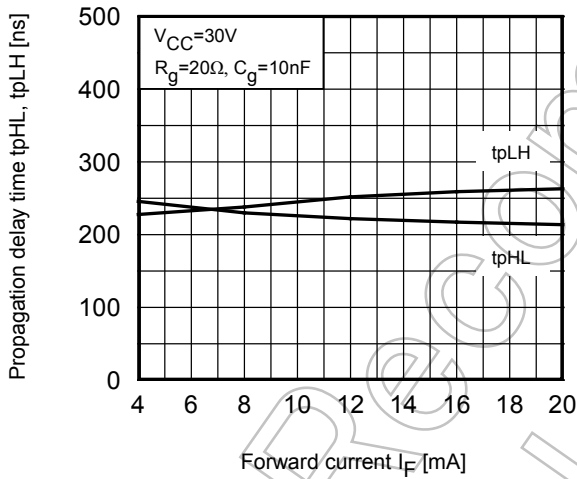

IFLH - Ta

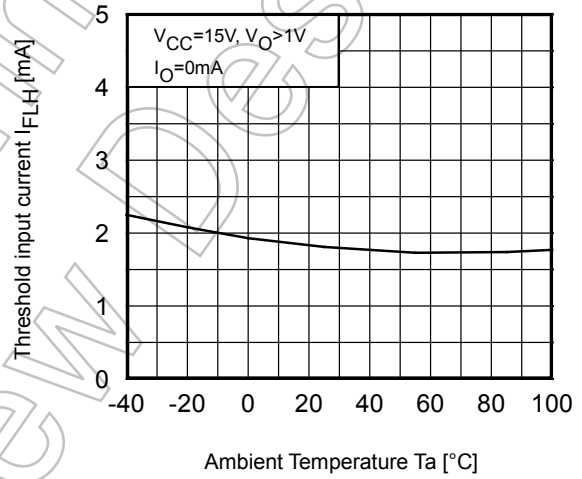

IOPL - Ta

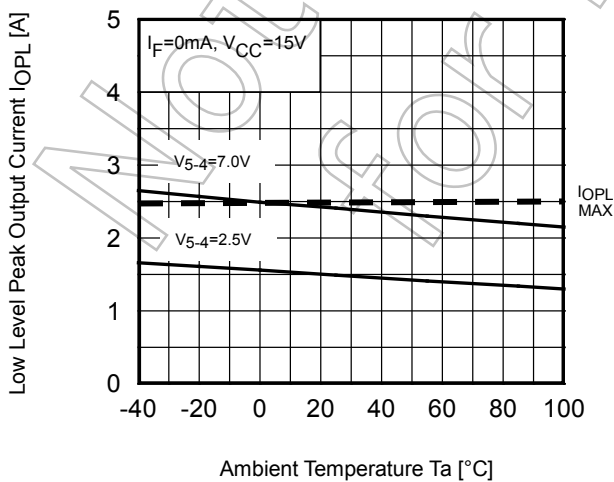

IOPH - Ta

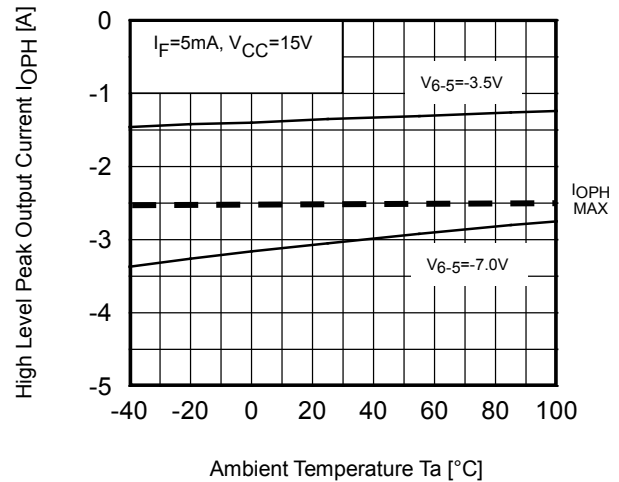

NOTE: The above characteristics curves are presented for reference only and not guaranteed by production test, unless otherwise noted.

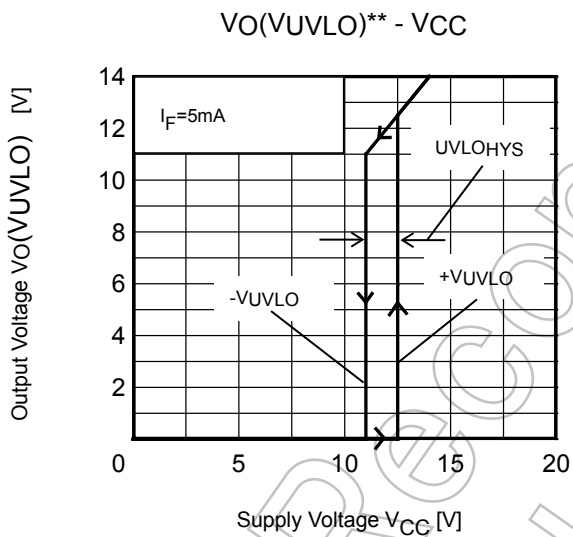
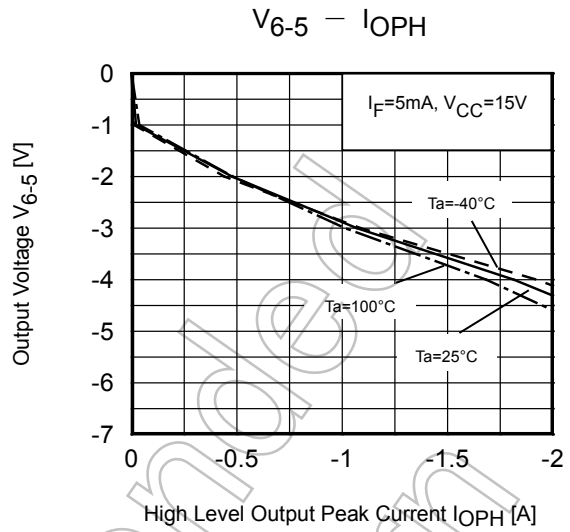
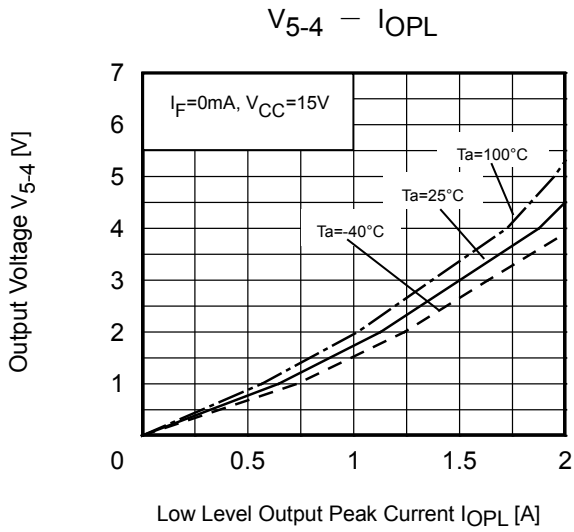

\*\*Test Circuit :  $V_O(V_{UVLO}) - V_{CC}$

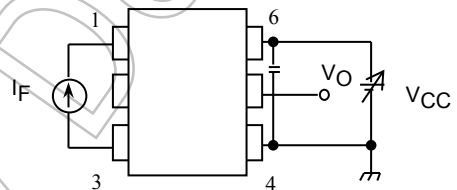

\*: The above graphs show typical characteristics.

NOTE: The above characteristics curves are presented for reference only and not guaranteed by production test, unless otherwise noted.



## Soldering and Storage

### (1) Precautions for Soldering

The soldering temperature should be controlled as closely as possible to the conditions shown below, irrespective of whether a soldering iron or a reflow soldering method is used.

#### 1) When Using Soldering Reflow

The soldering temperature profile is based on the package surface temperature.

(See the figure shown below, which is based on the package surface temperature.)

Reflow soldering must be performed once or twice.

The mounting should be completed with the interval from the first to the last mountings being 2 weeks.

- An example of a temperature profile when lead(Pb)-free solder is used:

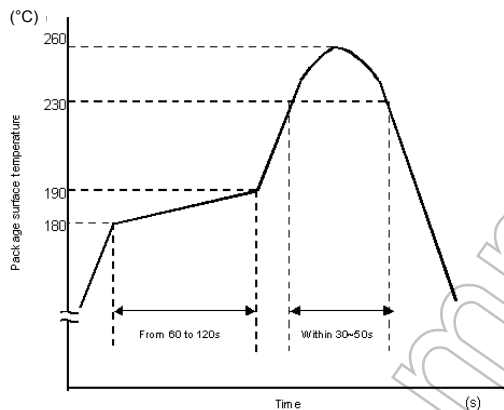

This profile is based on the device's maximum heat resistance guaranteed value.

Set the preheat temperature/heating temperature to the optimum temperature corresponding to the solder paste type used by the customer within the described profile.

#### 2) When using soldering flow

- Preheat the device at a temperature of 150 °C (package surface temperature) for 60 to 120 seconds.
- Mounting condition of 260 °C within 10 seconds is recommended.
- Flow soldering must be performed once

#### 3) When using soldering Iron

- Complete soldering within 10 seconds for lead temperature not exceeding 260 °C or within 3 seconds not exceeding 350 °C.
- Heating by soldering iron must be only once per 1 lead

---

**(2) Precautions for General Storage**

- 1) Do not store devices at any place where they will be exposed to moisture or direct sunlight.
- 2) When transportation or storage of devices, follow the cautions indicated on the carton box.
- 3) The storage area temperature should be kept within a temperature range of 5 °C to 35 °C, and relative humidity should be maintained at between 45% and 75%.
- 4) Do not store devices in the presence of harmful (especially corrosive) gases, or in dusty conditions.
- 5) Use storage areas where there is minimal temperature fluctuation. Because rapid temperature changes can cause condensation to occur on stored devices, resulting in lead oxidation or corrosion, as a result, the solderability of the leads will be degraded.
- 6) When repacking devices, use anti-static containers.
- 7) Do not apply any external force or load directly to devices while they are in storage.
- 8) If devices have been stored for more than two years, even though the above conditions have been followed, it is recommended that solderability of them should be tested before they are used.

Not Recommended  
for New Design

## EN 60747-5-5 Option (D4) Specification

Types : TLP700

Type designations for “option: (D4)”, which are tested under EN 60747 requirements.

Ex.: TLP700 (D4-TP,F)      D4 : EN 60747 option  
 TP : Standard tape & reel type  
 F : [[G]]/RoHS COMPATIBLE (Note 1)

Note: Use TOSHIBA standard type number for safety standard application.

Ex.: TLP700 (D4-TP,F) → TLP700



Note 1: Please contact your TOSHIBA sales representative for details as to environmental matters such as the RoHS compatibility of Product.

RoHS is the Directive 2011/65/EU of the European Parliament and of the Council of 8 June 2011 on the restriction of the use of certain hazardous substances in electrical and electronic equipment.

### EN 60747 Isolation Characteristics

Description		Symbol	Rating	Unit
Application classification for rated mains voltage ≤ 300V <sub>rms</sub> for rated mains voltage ≤ 600V <sub>rms</sub>			I-IV I-III	—
Climatic classification			40/ 100 / 21	—
Pollution degree			2	—
Maximum operating insulation voltage	TLPxxx type	V <sub>IORM</sub>	890	V <sub>pk</sub>
	TLPxxxFtype		1140	
Input to output test voltage, method A V <sub>pr</sub> =1.6 × V <sub>IORM</sub> , type and sample test t <sub>p</sub> =10 s, partial discharge < 5 pC	TLPxxx type	V <sub>pr</sub>	1424	V <sub>pk</sub>
	TLPxxxFtype		1824	
Input to output test voltage, method B V <sub>pr</sub> =1.875 × V <sub>IORM</sub> , 100 % production test t <sub>p</sub> =1 s, partial discharge < 5 pC	TLPxxx type	V <sub>pr</sub>	1670	V <sub>pk</sub>
	TLPxxxFtype		2140	
Highest permissible overvoltage (transient overvoltage, t <sub>pr</sub> = 60 s)		V <sub>TR</sub>	8000	V <sub>pk</sub>
Safety limiting values (max. permissible ratings in case of fault, also refer to thermal derating curve) current (input current I <sub>F</sub> , P <sub>si</sub> = 0) power (output or total power dissipation) temperature		I <sub>si</sub> P <sub>si</sub> T <sub>s</sub>	300 700 150	mA mW °C
Insulation resistance,	V <sub>IO</sub> =500 V, Ta = 25 °C V <sub>IO</sub> =500 V, Ta = 100 °C V <sub>IO</sub> =500 V, Ta = Ts	R <sub>si</sub>	≥10 <sup>12</sup> ≥10 <sup>11</sup> ≥10 <sup>9</sup>	Ω

### Insulation Related Specifications

		 7.62mm pitch TLPxxx type	 10.16mm pitch TLPxxxF type
Minimum creepage distance	Cr	7.0mm	8.0mm
Minimum clearance	Cl	7.0mm	8.0mm
Minimum insulation thickness	ti	0.4mm	
Comperative tracking index	CTI	175	

1. If a printed circuit is incorporated, the creepage distance and clearance may be reduced below this value. If this is not permissible, the user shall take suitable measures.
2. This photocoupler is suitable for 'safe electrical isolation' only within the safety limit data. Maintenance of the safety data shall be ensured by means of protective circuits.

Marking on product for EN 60747 : **4**

Marking Example:

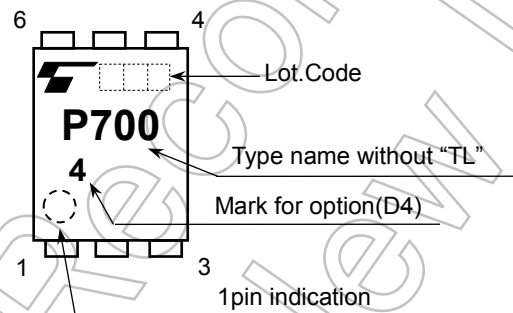

Figure 1 Partial discharge measurement procedure according to EN 60747  
Destructive test for qualification and sampling tests.

Method A

(for type and sampling tests,  
destructive tests)

- t1, t2 = 1 to 10 s
- t3, t4 = 1 s
- tp (Measuring time for partial discharge) = 10 s
- tb = 12 s
- tini = 60 s

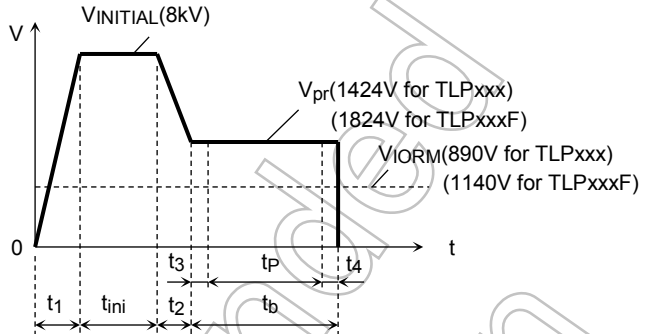

Figure 2 Partial discharge measurement procedure according to EN 60747  
Non-destructive test for 100% inspection.

Method B

(for sample test, non-destructive test)

- t3, t4 = 0.1 s
- tp (Measuring time for partial discharge) = 1 s
- tb = 1.2 s

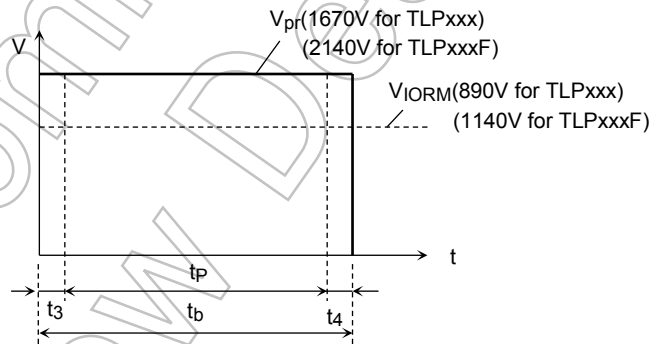
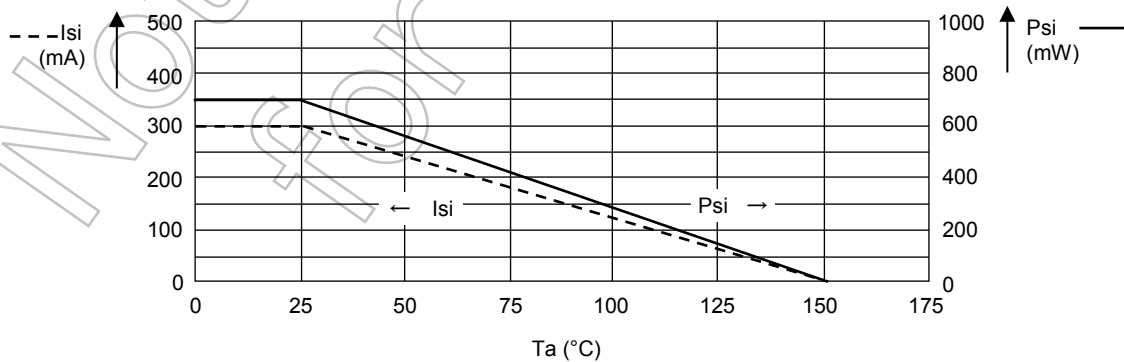

Figure 3 Dependency of maximum safety ratings on ambient temperature



---

## RESTRICTIONS ON PRODUCT USE

Toshiba Corporation and its subsidiaries and affiliates are collectively referred to as "TOSHIBA". Hardware, software and systems described in this document are collectively referred to as "Product".

- TOSHIBA reserves the right to make changes to the information in this document and related Product without notice.
- This document and any information herein may not be reproduced without prior written permission from TOSHIBA. Even with TOSHIBA's written permission, reproduction is permissible only if reproduction is without alteration/omission.
- Though TOSHIBA works continually to improve Product's quality and reliability, Product can malfunction or fail. Customers are responsible for complying with safety standards and for providing adequate designs and safeguards for their hardware, software and systems which minimize risk and avoid situations in which a malfunction or failure of Product could cause loss of human life, bodily injury or damage to property, including data loss or corruption. Before customers use the Product, create designs including the Product, or incorporate the Product into their own applications, customers must also refer to and comply with (a) the latest versions of all relevant TOSHIBA information, including without limitation, this document, the specifications, the data sheets and application notes for Product and the precautions and conditions set forth in the "TOSHIBA Semiconductor Reliability Handbook" and (b) the instructions for the application with which the Product will be used with or for. Customers are solely responsible for all aspects of their own product design or applications, including but not limited to (a) determining the appropriateness of the use of this Product in such design or applications; (b) evaluating and determining the applicability of any information contained in this document, or in charts, diagrams, programs, algorithms, sample application circuits, or any other referenced documents; and (c) validating all operating parameters for such designs and applications. **TOSHIBA ASSUMES NO LIABILITY FOR CUSTOMERS' PRODUCT DESIGN OR APPLICATIONS.**
- **PRODUCT IS NEITHER INTENDED NOR WARRANTED FOR USE IN EQUIPMENTS OR SYSTEMS THAT REQUIRE EXTRAORDINARILY HIGH LEVELS OF QUALITY AND/OR RELIABILITY, AND/OR A MALFUNCTION OR FAILURE OF WHICH MAY CAUSE LOSS OF HUMAN LIFE, BODILY INJURY, SERIOUS PROPERTY DAMAGE AND/OR SERIOUS PUBLIC IMPACT ("UNINTENDED USE").** Except for specific applications as expressly stated in this document, Unintended Use includes, without limitation, equipment used in nuclear facilities, equipment used in the aerospace industry, lifesaving and/or life supporting medical equipment, equipment used for automobiles, trains, ships and other transportation, traffic signaling equipment, equipment used to control combustions or explosions, safety devices, elevators and escalators, and devices related to power plant. **IF YOU USE PRODUCT FOR UNINTENDED USE, TOSHIBA ASSUMES NO LIABILITY FOR PRODUCT.** For details, please contact your TOSHIBA sales representative or contact us via our website.
- Do not disassemble, analyze, reverse-engineer, alter, modify, translate or copy Product, whether in whole or in part.
- Product shall not be used for or incorporated into any products or systems whose manufacture, use, or sale is prohibited under any applicable laws or regulations.
- The information contained herein is presented only as guidance for Product use. No responsibility is assumed by TOSHIBA for any infringement of patents or any other intellectual property rights of third parties that may result from the use of Product. No license to any intellectual property right is granted by this document, whether express or implied, by estoppel or otherwise.
- **ABSENT A WRITTEN SIGNED AGREEMENT, EXCEPT AS PROVIDED IN THE RELEVANT TERMS AND CONDITIONS OF SALE FOR PRODUCT, AND TO THE MAXIMUM EXTENT ALLOWABLE BY LAW, TOSHIBA (1) ASSUMES NO LIABILITY WHATSOEVER, INCLUDING WITHOUT LIMITATION, INDIRECT, CONSEQUENTIAL, SPECIAL, OR INCIDENTAL DAMAGES OR LOSS, INCLUDING WITHOUT LIMITATION, LOSS OF PROFITS, LOSS OF OPPORTUNITIES, BUSINESS INTERRUPTION AND LOSS OF DATA, AND (2) DISCLAIMS ANY AND ALL EXPRESS OR IMPLIED WARRANTIES AND CONDITIONS RELATED TO SALE, USE OF PRODUCT, OR INFORMATION, INCLUDING WARRANTIES OR CONDITIONS OF MERCHANTABILITY, FITNESS FOR A PARTICULAR PURPOSE, ACCURACY OF INFORMATION, OR NONINFRINGEMENT.**
- GaAs (Gallium Arsenide) is used in Product. GaAs is harmful to humans if consumed or absorbed, whether in the form of dust or vapor. Handle with care and do not break, cut, crush, grind, dissolve chemically or otherwise expose GaAs in Product.
- Do not use or otherwise make available Product or related software or technology for any military purposes, including without limitation, for the design, development, use, stockpiling or manufacturing of nuclear, chemical, or biological weapons or missile technology products (mass destruction weapons). Product and related software and technology may be controlled under the applicable export laws and regulations including, without limitation, the Japanese Foreign Exchange and Foreign Trade Law and the U.S. Export Administration Regulations. Export and re-export of Product or related software or technology are strictly prohibited except in compliance with all applicable export laws and regulations.
- Please contact your TOSHIBA sales representative for details as to environmental matters such as the RoHS compatibility of Product. Please use Product in compliance with all applicable laws and regulations that regulate the inclusion or use of controlled substances, including without limitation, the EU RoHS Directive. **TOSHIBA ASSUMES NO LIABILITY FOR DAMAGES OR LOSSES OCCURRING AS A RESULT OF NONCOMPLIANCE WITH APPLICABLE LAWS AND REGULATIONS.**