

TLP3312

Applications

Battery Control

Measuring Instruments

Logic IC Testers / Memory Testers

General

The TOSHIBA TLP3312 is an ultra-small photorelay suitable for surface-mount assembly. The TLP3312 consists of a GaAs infrared-emitting diode optically coupled to a photo-MOSFET and is housed in a 4-pin package.

Its features include low Off-state current and low output pin capacitance.

Features

- 4-pin USOP (SSOP4): height=1.65 mm, pitch=1.27 mm
- 1-Form-A
- Peak Off-State Voltage: 60 V (min)
- Trigger LED Current: 3 mA (max)
- On-State Current: 400 mA (max)
- On-State Resistance: 1.5 Ω (max), 1.0 Ω (typ.)
- Isolation Voltage: 1000 Vrms (min)
- UL approved: UL1577, File No.E67349

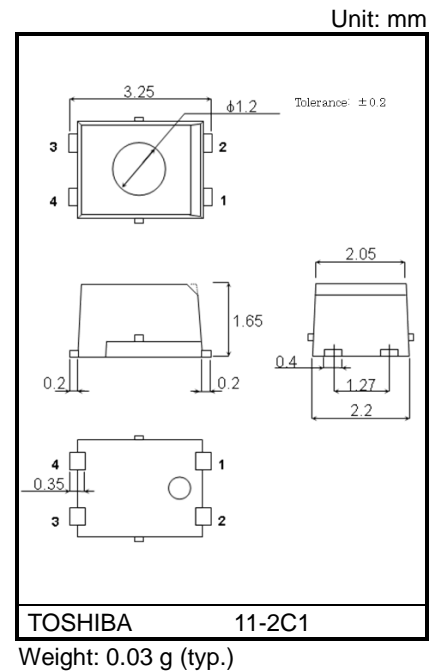

Pin Configuration (Top View)

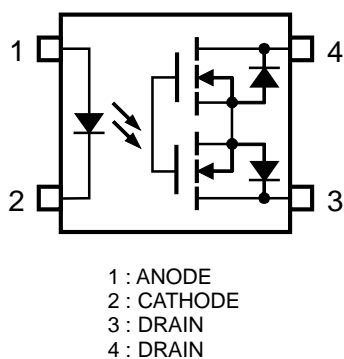

Schematic

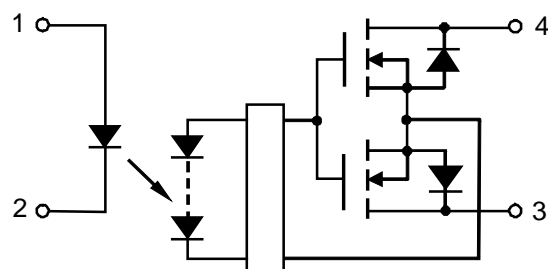

Start of commercial production
2009-03

Absolute Maximum Ratings (Ta = 25°C)

CHARACTERISTIC		SYMBOL	RATING	UNIT
LED	Forward Current	I _F	50	mA
	Forward Current Derating (Ta ≥ 25°C)	ΔI _F /°C	-0.5	mA/°C
	Reverse Voltage	V _R	5	V
	Diode Power Dissipation	P _D	50	mW
	Diode Power Dissipation Derating (Ta ≥ 25°C)	ΔP _D /°C	-0.5	mW/°C
	Junction Temperature	T _j	125	°C
DETECTOR	Off-State Output Terminal Voltage	V _{OFF}	60	V
	On-State Current	I _{ON}	400	mA
	On-State Current Derating (Ta ≥ 25°C)	ΔI _{ON} /°C	-4.0	mA/°C
	Output Power Dissipation	P _O	240	mW
	Output Power Dissipation Derating (Ta ≥ 25°C)	ΔP _O /°C	-2.4	mW / °C
	Junction Temperature	T _j	125	°C
Storage Temperature Range		T _{stg}	-40 to 125	°C
Operating Temperature Range		T _{opr}	-40 to 85	°C
Lead Soldering Temperature (10 s)		T _{sol}	260	°C
Isolation Voltage (AC, 1 minute, R.H. ≤ 60%) (Note 1)		BV _S	1000	V _{rms}

Note: Using continuously under heavy loads (e.g. the application of high temperature/current/voltage and the significant change in temperature, etc.) may cause this product to decrease in the reliability significantly even if the operating conditions (i.e. operating temperature/current/voltage, etc.) are within the absolute maximum ratings.

Please design the appropriate reliability upon reviewing the Toshiba Semiconductor Reliability Handbook ("Handling Precautions"/"Derating Concept and Methods") and individual reliability data (i.e. reliability test report and estimated failure rate, etc).

Note1: Device considered a two-terminal device: Pins 1 and 2 shorted together, and pins 3 and 4 shorted together.

Caution

This device is sensitive to electrostatic discharge. When using this device, please ensure that all tools and equipment are earthed.

Recommended Operating Conditions

CHARACTERISTIC	SYMBOL	MIN	TYP.	MAX	UNIT
Supply Voltage	V _{DD}	—	—	48	V
Forward Current	I _F	—	—	20	mA
On-State Current	I _{ON}	—	—	400	mA
Operating Temperature	T _{opr}	-20	—	65	°C

Note: Recommended operating conditions are given as a design guideline to obtain expected performance of the devices. Each item also has its own independent guideline document. In developing designs using these products, please confirm the specified characteristics shown in these documents.

Individual Electrical Characteristics (Ta = 25°C)

CHARACTERISTIC		SYMBOL	TEST CONDITION	MIN	TYP.	MAX	UNIT
LED	Forward Voltage	V_F	$I_F = 10 \text{ mA}$	1.0	1.15	1.3	V
	Reverse Current	I_R	$V_R = 5 \text{ V}$	—	—	10	μA
	Capacitance	C_T	$V_F = 0\text{V}, f = 1 \text{ MHz}$	—	15	—	pF
DETECTOR	Off-State Current	I_{OFF}	$V_{OFF} = 60 \text{ V}$	—	—	1	nA
	Capacitance	C_{OFF}	$V = 0\text{V}, f = 1 \text{ MHz}, t < 1 \text{ s}$	—	20	—	pF

Coupled Electrical Characteristics (Ta = 25°C)

CHARACTERISTIC	SYMBOL	TEST CONDITION	MIN	TYP.	MAX	UNIT
Trigger LED Current	I _{FT}	I _{ON} = 100 mA	—	—	3	mA
Close LED Current	I _{FC}	I _{OFF} = 10 μA	0.2	—	—	mA
On-State Resistance	R _{ON}	I _{ON} = 400 mA, I _F = 5 mA	—	1.0	1.5	Ω

Isolation Characteristics (Ta = 25°C)

CHARACTERISTIC	SYMBOL	TEST CONDITION	MIN	TYP.	MAX	UNIT
Capacitance Input to Output	C _S	V _S = 0 V, f = 1 MHz	—	0.3	—	pF
Isolation Resistance	R _S	V _S = 500 V, R.H. ≤ 60%	5 × 10 ¹⁰	10 ¹⁴	—	Ω
Isolation Voltage	BV _S	AC, 1 minute	1000	—	—	V _{rms}

Switching Characteristics (Ta = 25°C)

CHARACTERISTIC	SYMBOL	TEST CONDITION	MIN	TYP.	MAX	UNIT
Turn-on Time	t _{ON}	R _L = 200 Ω (Note 2)	—	—	500	μs
Turn-off Time	t _{OFF}	V _{DD} = 20 V, I _F = 5 mA	—	—	500	

Note 2: Switching time test circuit

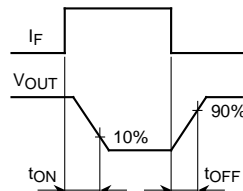
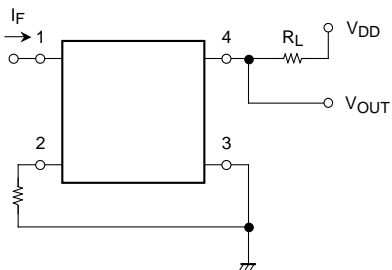

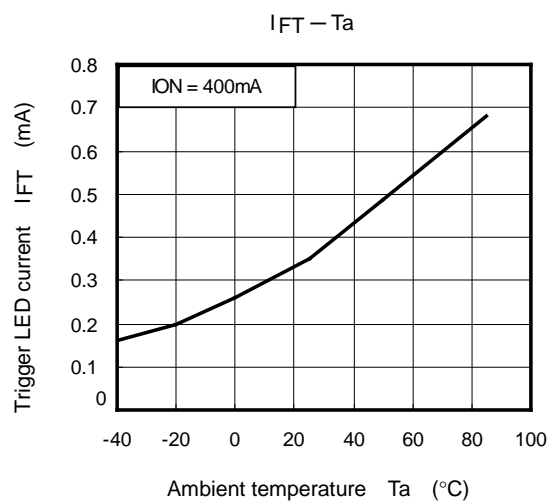
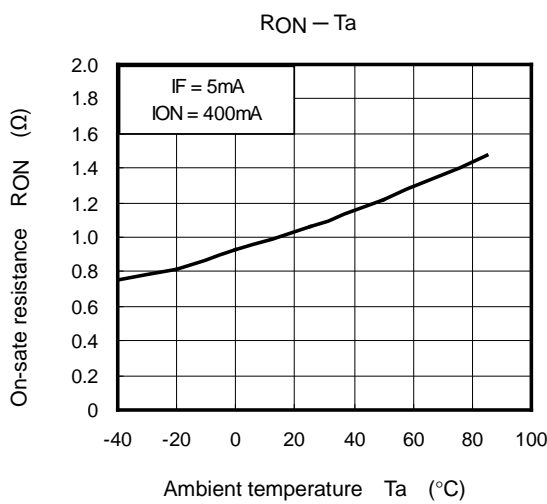
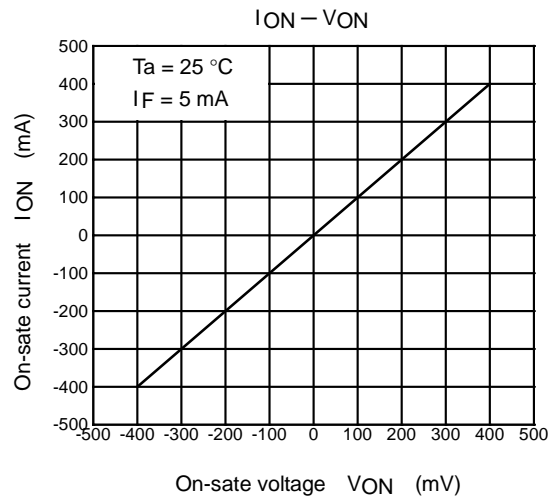
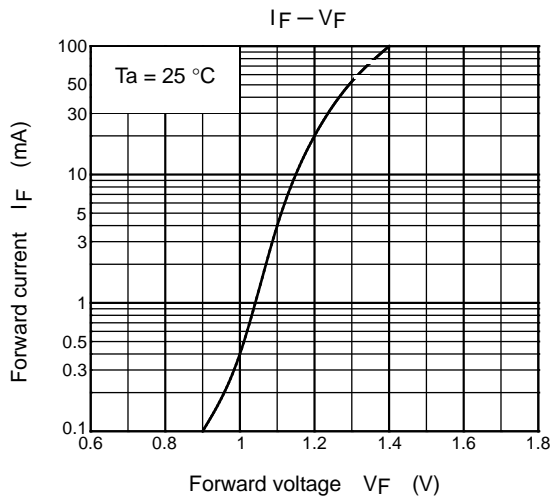
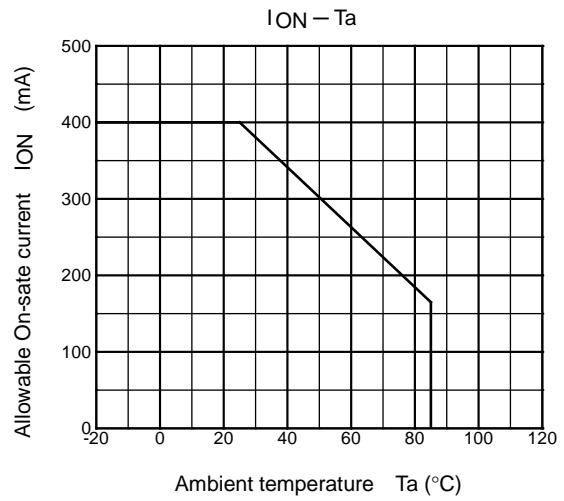
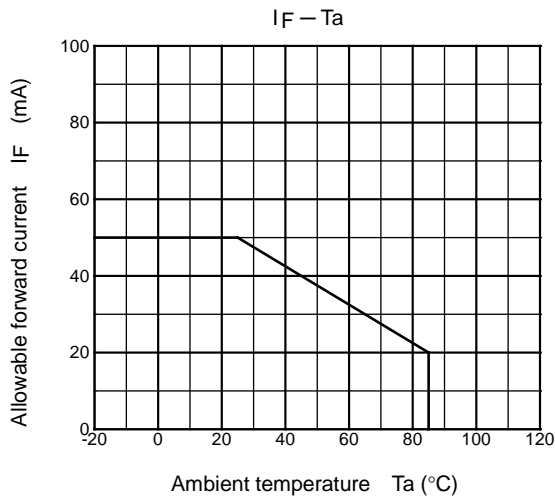

*: The above graphs show typical characteristics.

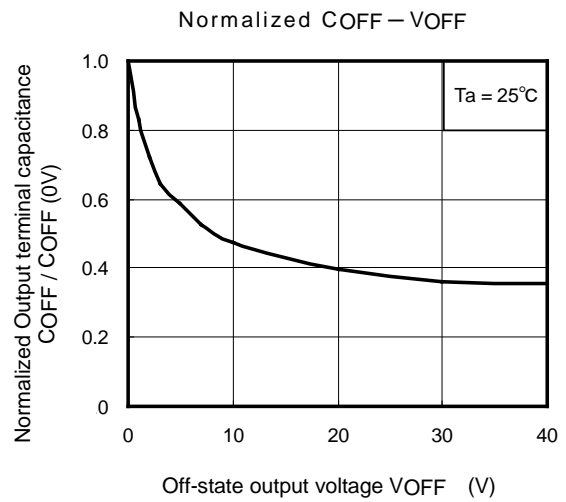
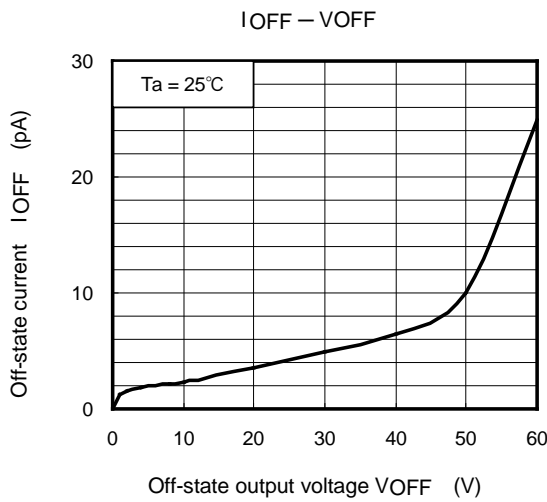
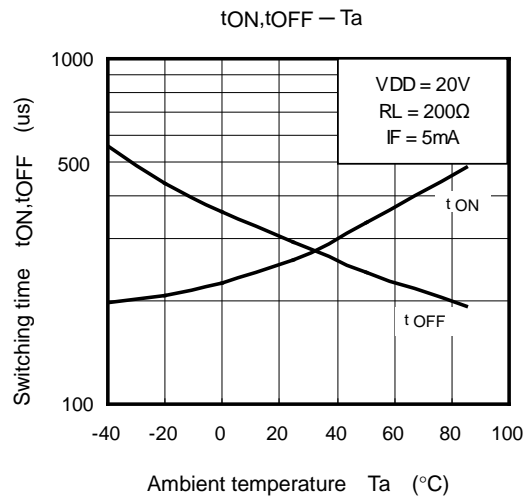
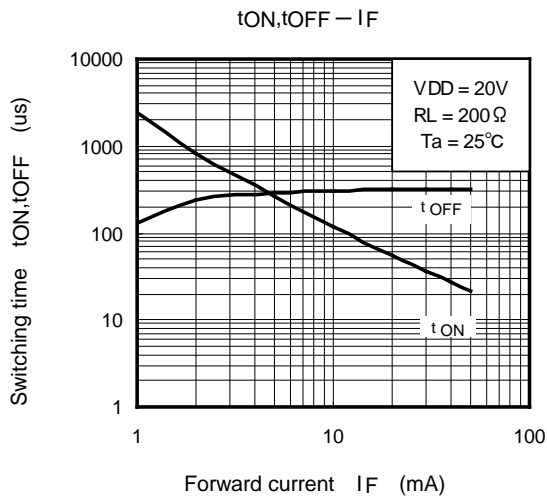

*: The above graphs show typical characteristics.

1. Recommended Soldering

Precautions about the Soldering of the SMD Type Photocoupler

<Types>

TLP3312

<Mounting Method>

1) Using Solder Reflow

- Temperature profile example of lead (Pb) solder

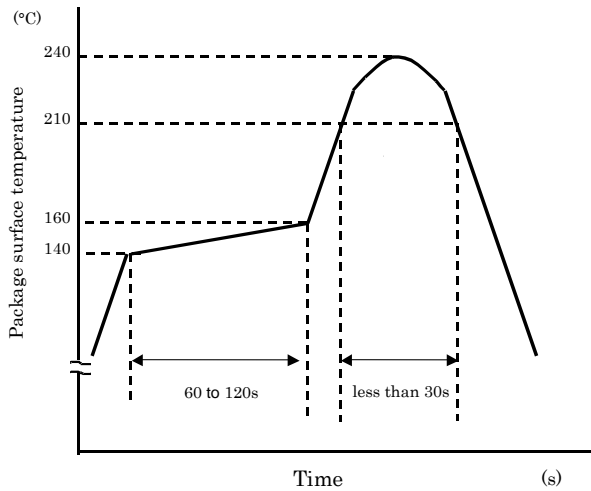

- Temperature profile example of using lead (Pb-free) solder

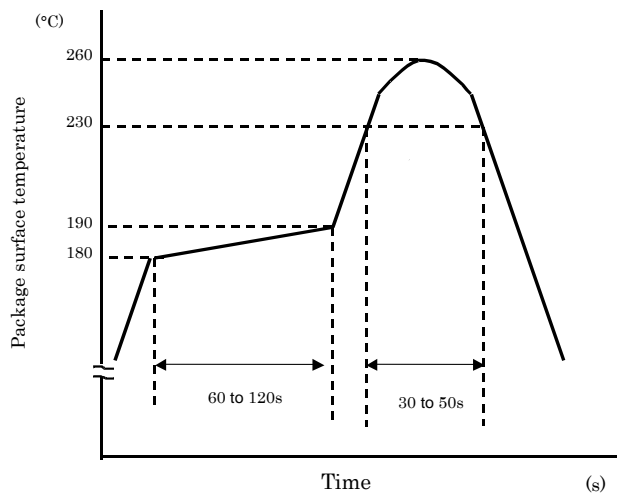

Reflow soldering must be performed once or twice.

2. Packing

Please use the device in a condition of the following because package breaking may occur when the USOP coupler catches the heat stress in the time of soldering in the state that exposure to moisture in the air.

1. This moisture-proof bag may be stored unopened for up to 12 months under the following conditions.
Temperature: 5°C to 30°C
Humidity: 90% (max)
2. After the moisture-proof bag has been opened, the devices should be assembled within 168 hours in an environment of 5°C to 30°C/70% RH or below.
3. If, upon opening, the moisture indicator card shows humidity of 30% or above (when the indication color changes to pink) or the expiration date has passed, the devices should be baked while packed in the tape reel. After baking, use the baked devices within 72 hours, but perform baking only once.
Baking conditions: 60 ±5°C, for 64 to 72 hours.
Expiration date: 12 months from the sealing date, which is imprinted on the same side as this label.
4. Repeated baking may cause the peeling strength of the tape to change, leading to trouble in mounting. Also, be sure to prevent damage to the device from static electricity during the baking process.
5. Any breakage in the laminate packing material will cause the hermeticity of the product to deteriorate. Do not toss or drop the packed devices.

RESTRICTIONS ON PRODUCT USE

Toshiba Corporation and its subsidiaries and affiliates are collectively referred to as "TOSHIBA". Hardware, software and systems described in this document are collectively referred to as "Product".

- TOSHIBA reserves the right to make changes to the information in this document and related Product without notice.
- This document and any information herein may not be reproduced without prior written permission from TOSHIBA. Even with TOSHIBA's written permission, reproduction is permissible only if reproduction is without alteration/omission.
- Though TOSHIBA works continually to improve Product's quality and reliability, Product can malfunction or fail. Customers are responsible for complying with safety standards and for providing adequate designs and safeguards for their hardware, software and systems which minimize risk and avoid situations in which a malfunction or failure of Product could cause loss of human life, bodily injury or damage to property, including data loss or corruption. Before customers use the Product, create designs including the Product, or incorporate the Product into their own applications, customers must also refer to and comply with (a) the latest versions of all relevant TOSHIBA information, including without limitation, this document, the specifications, the data sheets and application notes for Product and the precautions and conditions set forth in the "TOSHIBA Semiconductor Reliability Handbook" and (b) the instructions for the application with which the Product will be used with or for. Customers are solely responsible for all aspects of their own product design or applications, including but not limited to (a) determining the appropriateness of the use of this Product in such design or applications; (b) evaluating and determining the applicability of any information contained in this document, or in charts, diagrams, programs, algorithms, sample application circuits, or any other referenced documents; and (c) validating all operating parameters for such designs and applications. **TOSHIBA ASSUMES NO LIABILITY FOR CUSTOMERS' PRODUCT DESIGN OR APPLICATIONS.**
- **PRODUCT IS NEITHER INTENDED NOR WARRANTED FOR USE IN EQUIPMENTS OR SYSTEMS THAT REQUIRE EXTRAORDINARILY HIGH LEVELS OF QUALITY AND/OR RELIABILITY, AND/OR A MALFUNCTION OR FAILURE OF WHICH MAY CAUSE LOSS OF HUMAN LIFE, BODILY INJURY, SERIOUS PROPERTY DAMAGE AND/OR SERIOUS PUBLIC IMPACT ("UNINTENDED USE").** Except for specific applications as expressly stated in this document, Unintended Use includes, without limitation, equipment used in nuclear facilities, equipment used in the aerospace industry, lifesaving and/or life supporting medical equipment, equipment used for automobiles, trains, ships and other transportation, traffic signaling equipment, equipment used to control combustions or explosions, safety devices, elevators and escalators, and devices related to power plant. **IF YOU USE PRODUCT FOR UNINTENDED USE, TOSHIBA ASSUMES NO LIABILITY FOR PRODUCT.** For details, please contact your TOSHIBA sales representative or contact us via our website.
- Do not disassemble, analyze, reverse-engineer, alter, modify, translate or copy Product, whether in whole or in part.
- Product shall not be used for or incorporated into any products or systems whose manufacture, use, or sale is prohibited under any applicable laws or regulations.
- The information contained herein is presented only as guidance for Product use. No responsibility is assumed by TOSHIBA for any infringement of patents or any other intellectual property rights of third parties that may result from the use of Product. No license to any intellectual property right is granted by this document, whether express or implied, by estoppel or otherwise.
- **ABSENT A WRITTEN SIGNED AGREEMENT, EXCEPT AS PROVIDED IN THE RELEVANT TERMS AND CONDITIONS OF SALE FOR PRODUCT, AND TO THE MAXIMUM EXTENT ALLOWABLE BY LAW, TOSHIBA (1) ASSUMES NO LIABILITY WHATSOEVER, INCLUDING WITHOUT LIMITATION, INDIRECT, CONSEQUENTIAL, SPECIAL, OR INCIDENTAL DAMAGES OR LOSS, INCLUDING WITHOUT LIMITATION, LOSS OF PROFITS, LOSS OF OPPORTUNITIES, BUSINESS INTERRUPTION AND LOSS OF DATA, AND (2) DISCLAIMS ANY AND ALL EXPRESS OR IMPLIED WARRANTIES AND CONDITIONS RELATED TO SALE, USE OF PRODUCT, OR INFORMATION, INCLUDING WARRANTIES OR CONDITIONS OF MERCHANTABILITY, FITNESS FOR A PARTICULAR PURPOSE, ACCURACY OF INFORMATION, OR NONINFRINGEMENT.**
- GaAs (Gallium Arsenide) is used in Product. GaAs is harmful to humans if consumed or absorbed, whether in the form of dust or vapor. Handle with care and do not break, cut, crush, grind, dissolve chemically or otherwise expose GaAs in Product.
- Do not use or otherwise make available Product or related software or technology for any military purposes, including without limitation, for the design, development, use, stockpiling or manufacturing of nuclear, chemical, or biological weapons or missile technology products (mass destruction weapons). Product and related software and technology may be controlled under the applicable export laws and regulations including, without limitation, the Japanese Foreign Exchange and Foreign Trade Law and the U.S. Export Administration Regulations. Export and re-export of Product or related software or technology are strictly prohibited except in compliance with all applicable export laws and regulations.
- Please contact your TOSHIBA sales representative for details as to environmental matters such as the RoHS compatibility of Product. Please use Product in compliance with all applicable laws and regulations that regulate the inclusion or use of controlled substances, including without limitation, the EU RoHS Directive. **TOSHIBA ASSUMES NO LIABILITY FOR DAMAGES OR LOSSES OCCURRING AS A RESULT OF NONCOMPLIANCE WITH APPLICABLE LAWS AND REGULATIONS.**

TOSHIBA ELECTRONIC DEVICES & STORAGE CORPORATION

<https://toshiba.semicon-storage.com/>