

**TLRM1052(T20),TLRMM1052(T20),TLSM1052(T20),  
TLOM1052(T20),TLYM1052(T20)**

Unit: mm

**Panel Circuit Indicator**

- 5.2 (L) × 5.2 (W) × 4.0 (H) mm
- $\phi$  3.6 × 4.4 mm transparent lens top type
- InGaAlP LEDs
- High luminous intensity and low power consumption.
- Color : red, orange, yellow
- High operating temperature  
T<sub>opr</sub> : -40 to 100°C / T<sub>stg</sub>: -40 to 110°C
- Surface-mount devices
- Standard embossed tape packing  
8-mm component pitch: T20 (400 pcs/reel)
- Reflow-soldering is available
- Applications: amusement, message signboards, automotive interiors and exteriors, etc.

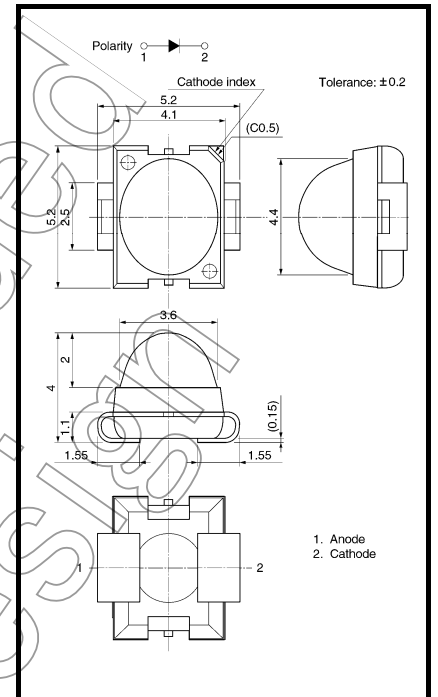

**Color and Material**

Part Number	Color	Material
TLRM1052	Red	InGaAlP
TLRMM1052	Red	
TLSM1052	Red	
TLOM1052	Orange	
TLYM1052	Yellow	

JEDEC	—
JEITA	—
TOSHIBA	4-5AX1

Weight : 0.088 g (typ.)

## Absolute Maximum Ratings (Ta = 25°C)

Product Name	Forward Current I <sub>F</sub> (mA)	Reverse Voltage V <sub>R</sub> (V)	Power Dissipation P <sub>D</sub> (mW)	Operating Temperature T <sub>opr</sub> (°C)	Storage Temperature T <sub>stg</sub> (°C)
TLRM1052	50	4	135	-40 to 100	-40 to 110
TLRMM1052					
TLSM1052					
TLOM1052					
TLYM1052					

Note: Using continuously under heavy loads (e.g. the application of high temperature/current/voltage and the significant change in temperature, etc.) may cause this product to decrease in the reliability significantly even if the operating conditions (i.e. operating temperature/current/voltage, etc.) are within the absolute maximum ratings. Please design the appropriate reliability upon reviewing the Toshiba Semiconductor Reliability Handbook (“Handling Precautions”/“Derating Concept and Methods”) and individual reliability data (i.e. reliability test report and estimated failure rate, etc).

Note 1: Forward current derating

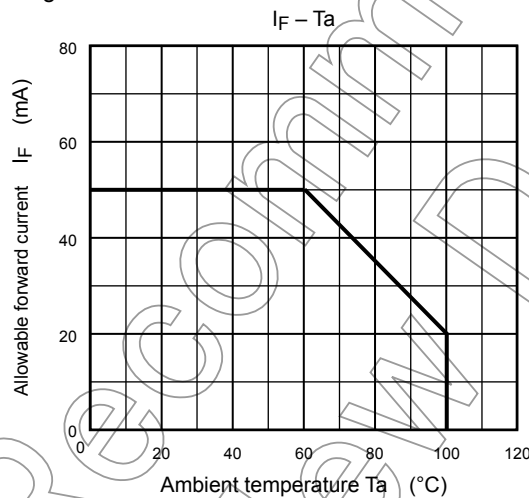

## Electrical Characteristics (Ta = 25°C)

Product Name	Forward Voltage V <sub>F</sub>			Reverse Current I <sub>R</sub>	
	Min	Typ.	Max	I <sub>F</sub>	V <sub>R</sub>
TLRM1052	2.0	2.3	2.7	20	10
TLRMM1052	2.0	2.3	2.7		
TLSM1052	2.0	2.3	2.7		
TLOM1052	2.0	2.3	2.7		
TLYM1052	2.0	2.3	2.7		
Unit	V			mA	μA

## Optical Characteristics-1-1 (Ta = 25°C)

Product Name	Luminous Intensity I <sub>v</sub>			I <sub>F</sub>	Corresponding brightness rank sign (Note 2)
	Min	Typ	Max		
TLRM1052	630	1200	3200	20	VA/WA/XA
TLRMM1052	630	1300	3200		VA/WA/XA
TLSM1052	1000	1900	5000		WA/XA/YA
TLOM1052	1000	2200	5000		WA/XA/YA
TLYM1052	1000	1900	5000		WA/XA/YA
Unit	mcd			mA	

Note 2: The specification on the above table is used for I<sub>v</sub> classification of LEDs in Toshiba facility. Each reel includes the same rank LEDs. Let the delivery ratio of each rank be unquestioned.

Brightness rank		
Rank sign	Min	Max
VA	630	1250
WA	1000	2000
XA	1600	3200
YA	2500	5000
Unit	mcd	mcd

## Optical Characteristics-2 (Ta = 25°C)

Product Name	Emission Spectrum							
	Peak Emission Wavelength λ <sub>p</sub>			Δλ Typ	Dominant Wavelength λ <sub>d</sub>			
	Min	Typ	Max		Min	Typ	Max	I <sub>F</sub>
TLRM1052	—	644	—	14	624	630	638	20
TLRMM1052	—	636	—	14	620	626	634	
TLSM1052	—	623	—	14	607	613	621	
TLOM1052	—	612	—	14	599	605	613	
TLYM1052	—	592	—	13	583	590	595	
Unit	nm			nm	nm			mA

### Caution

- This product is a product developed as a display source of light usage, and the measurement standard matched to the sensitivity of human eyes is applied. Therefore, functional usages (source of light for the sensor and the communication) other than the source of light for the display is not intended.

## TLRM1052

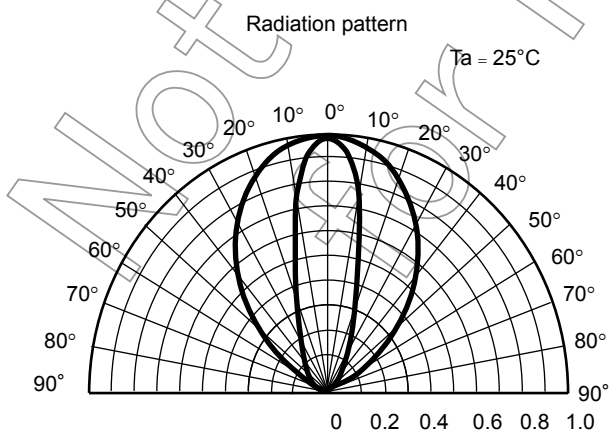
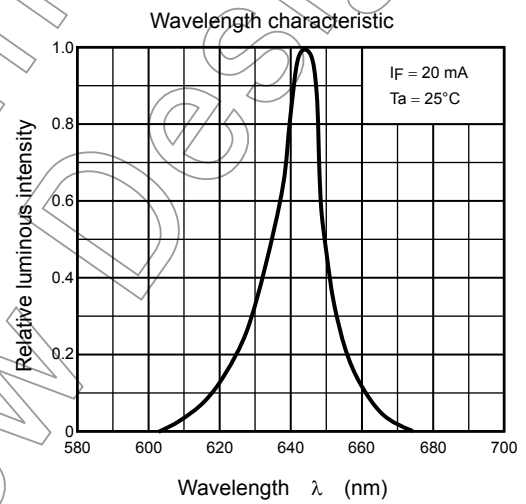
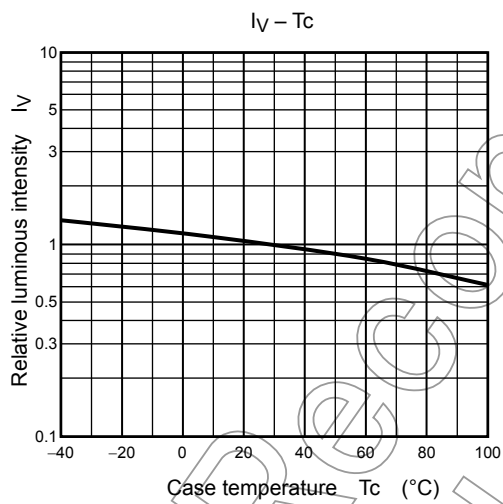
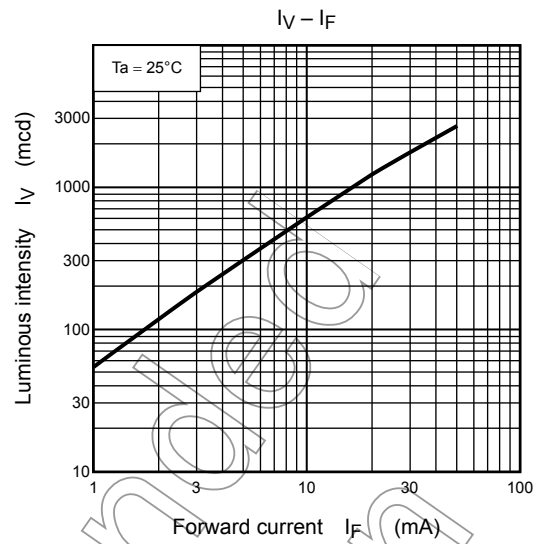
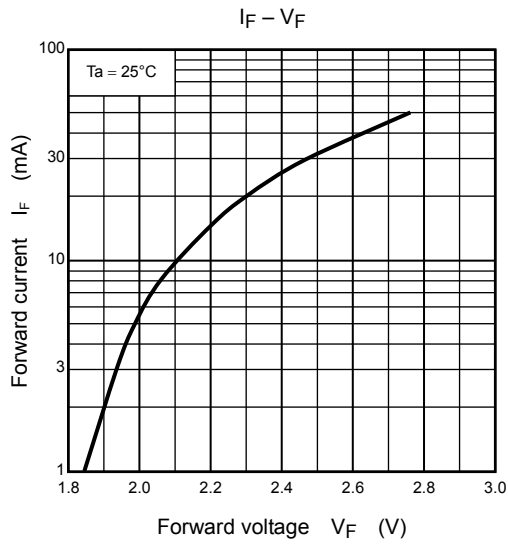

## TLRMM1052

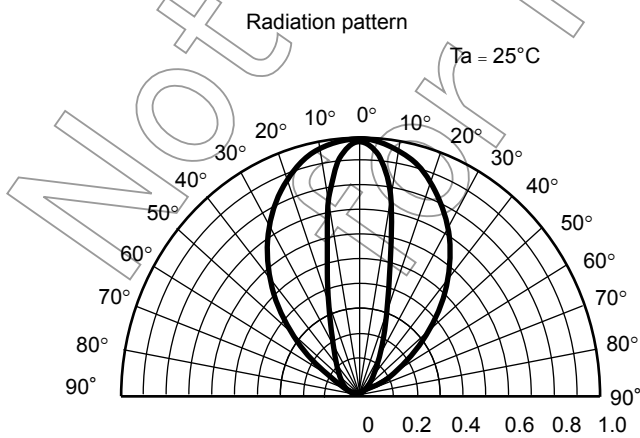
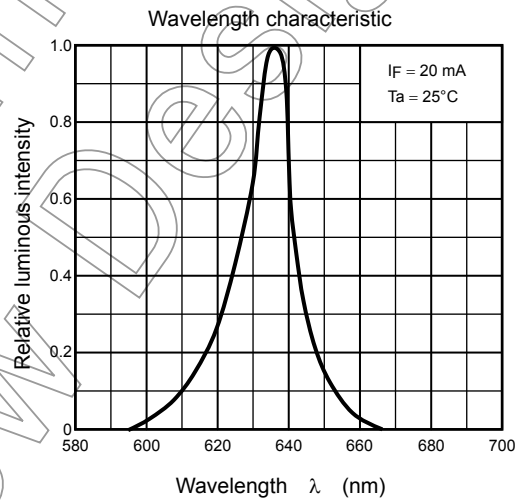
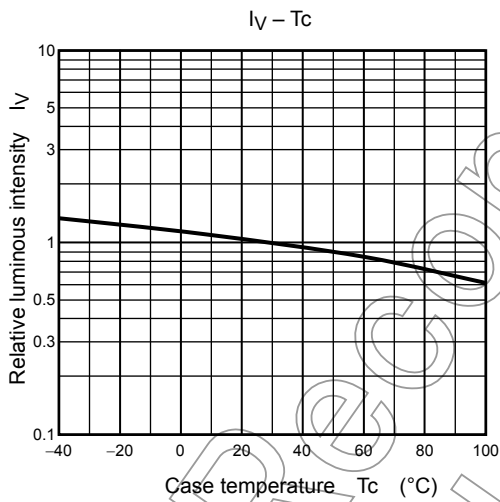
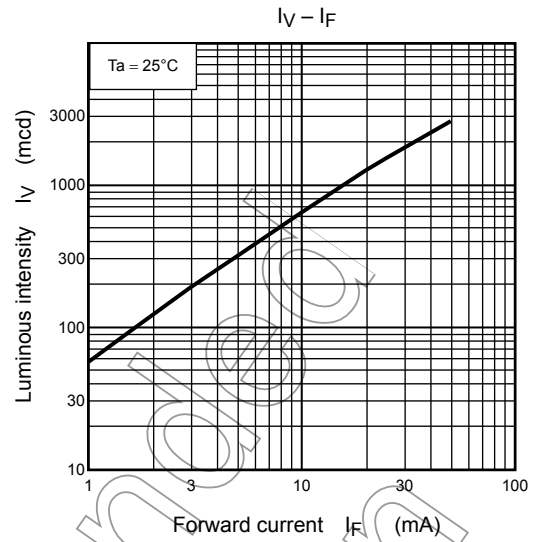
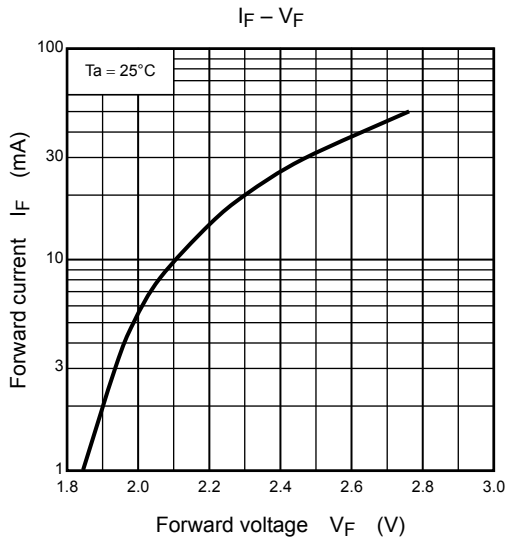

**TLSM1052**

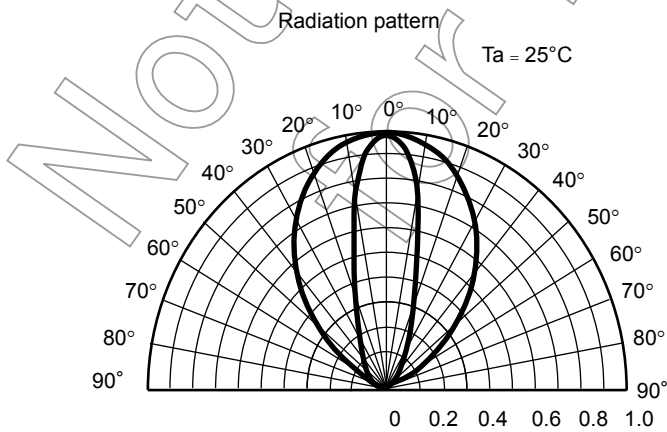
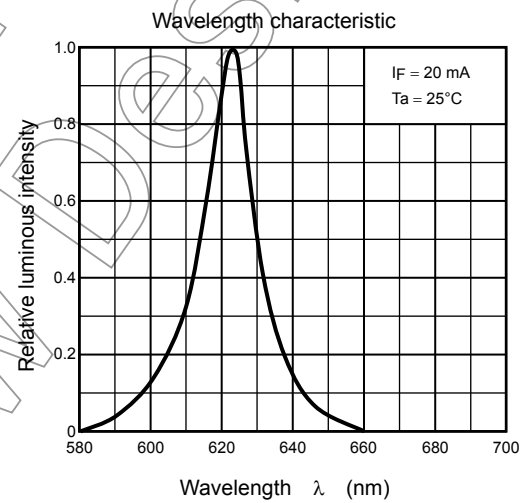
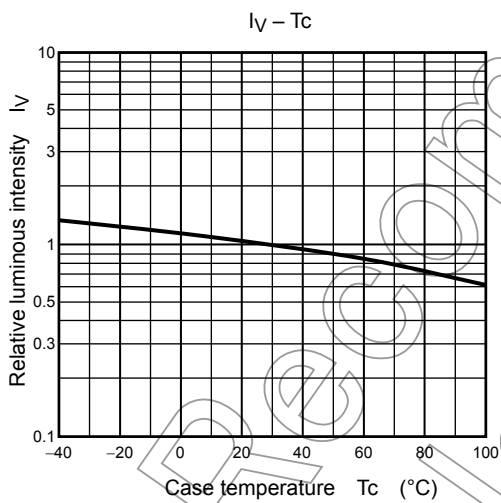
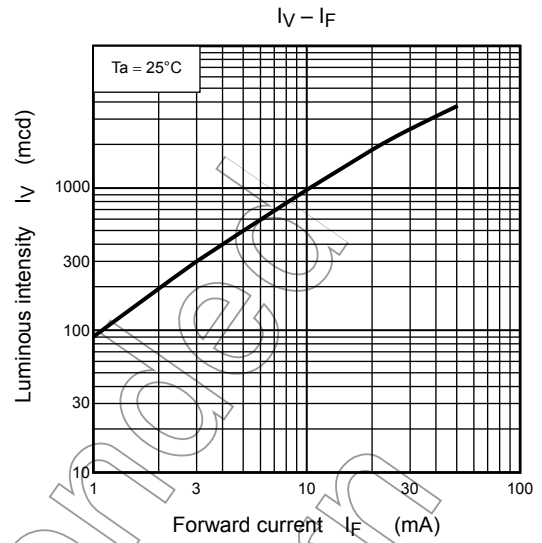
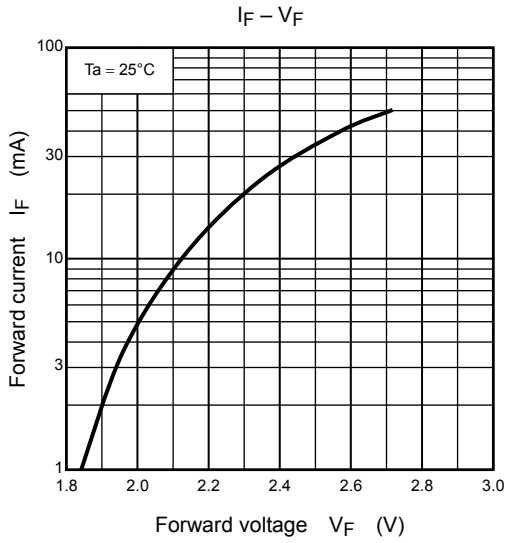

## TLOM1052

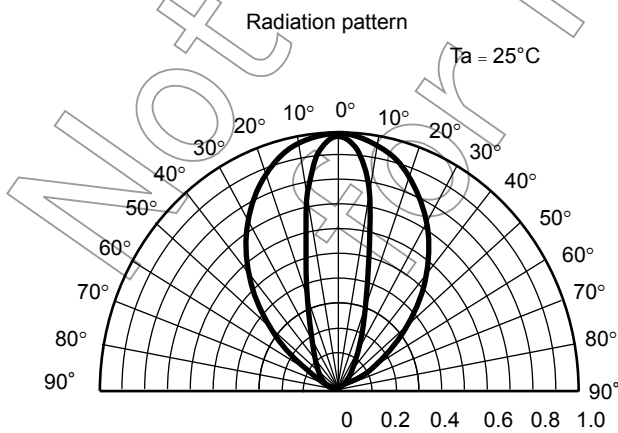
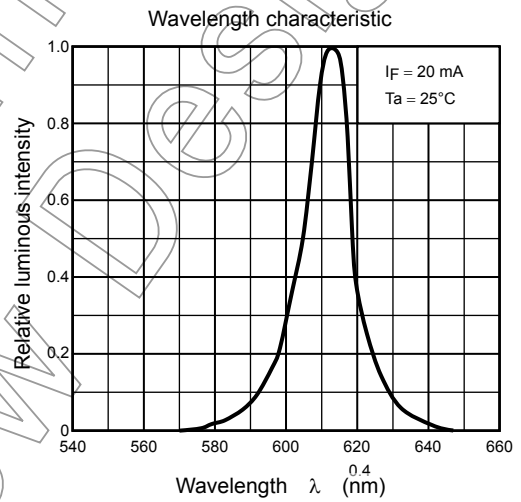
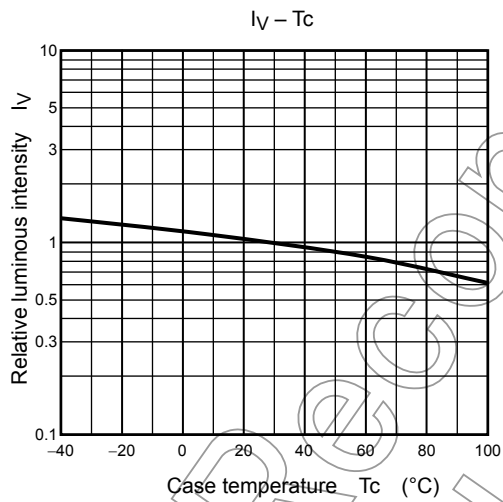
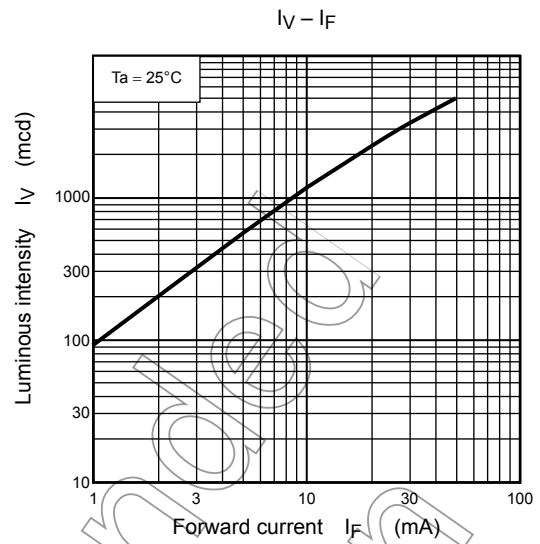
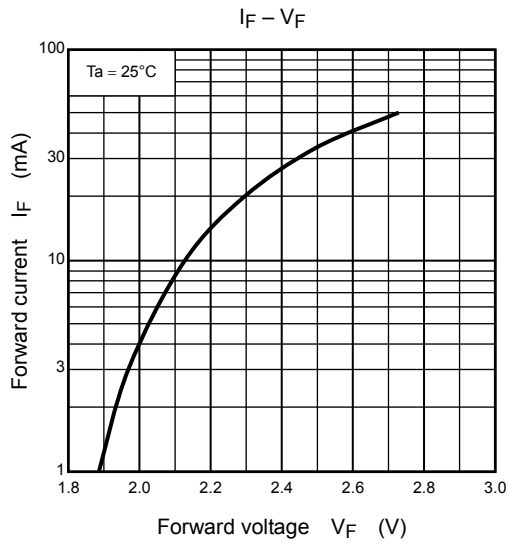

## TLYM1052

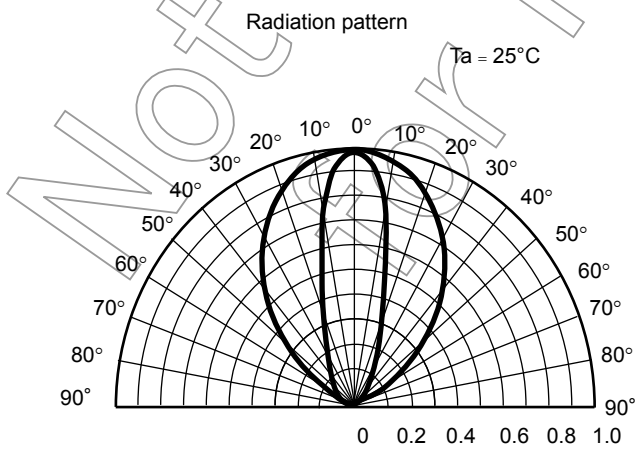
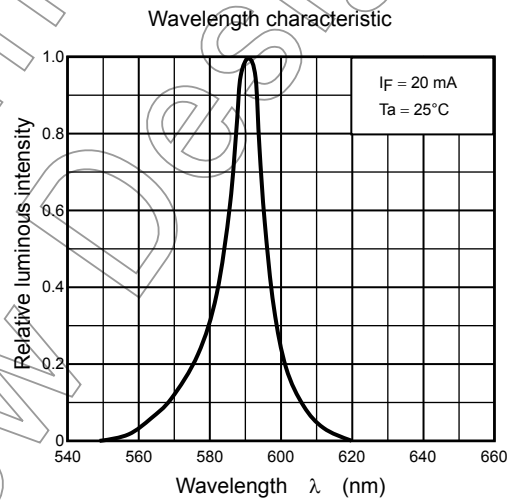
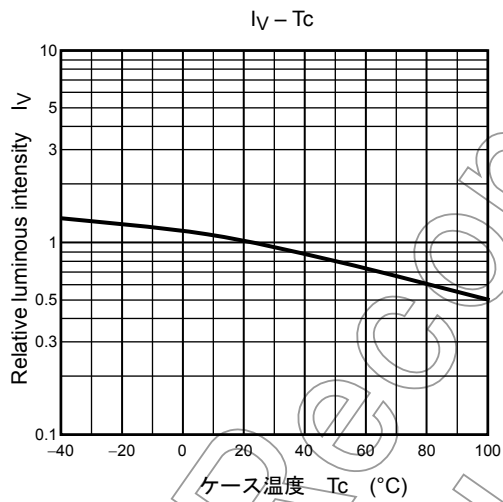
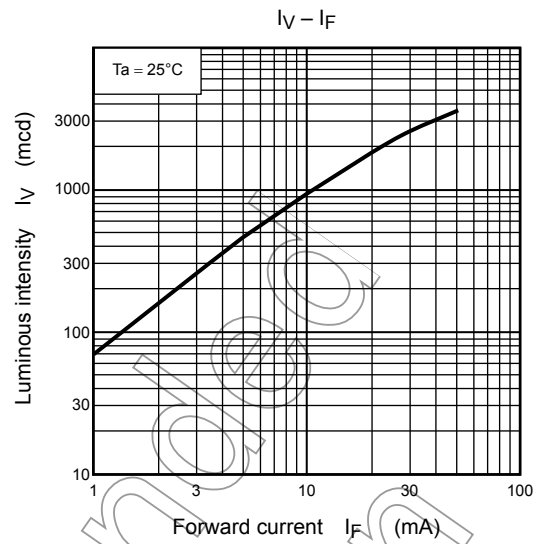
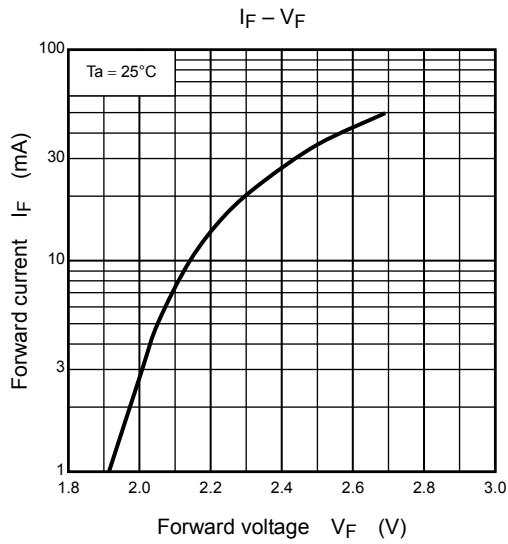



## Packaging

These LED devices are packed in an aluminum envelope with silica gel and a moisture indicator to prevent moisture absorption. The optical characteristics of the devices may be affected by exposure to moisture in the air before soldering and they should therefore be stored under the following conditions:

1. This moisture-proof bag may be stored unopened for up to 12 months under the following conditions.  
Temperature: 5°C to 30°C  
Humidity: 90% (max)
2. After the moisture-proof bag has been opened, the devices should be assembled within 168 hours in an environment of 5°C to 30°C/70% RH or below.
3. If, upon opening, the moisture indicator card shows humidity of 30% or above (when the indication color changes to pink) or the expiration date has passed, the devices should be baked while packed in the tape reel.  
After baking, use the baked devices within 72 hours, but perform baking only once.  
Baking conditions: 60 ±5°C, for 12 to 24 hours.  
Expiration date: 12 months from the sealing date, which is imprinted on the same side as this label.
4. Repeated baking may cause the peeling strength of the tape to change, leading to trouble in mounting. Also, be sure to prevent damage to the device from static electricity during the baking process.
5. Any breakage in the laminate packing material will cause the hermeticity of the product to deteriorate. Do not toss or drop the packed devices.

## Mounting Method

### Soldering

- Reflow soldering (example)

Temperature profile for Pb soldering (example)

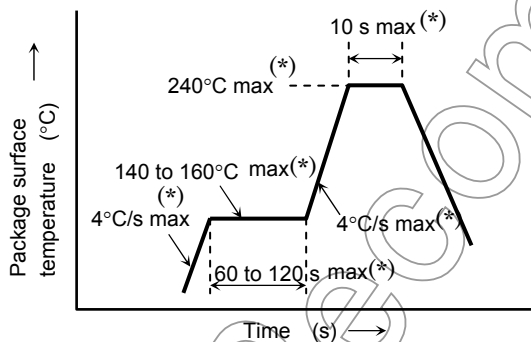

Temperature profile for Pb-free soldering (example)

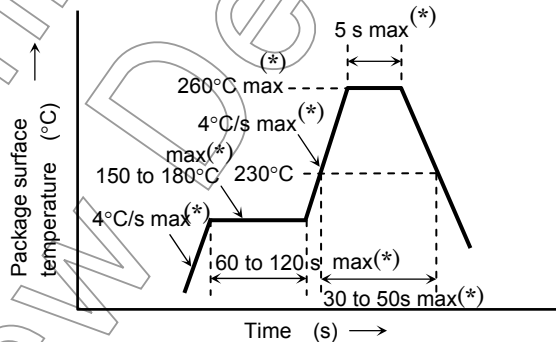

- The product is evaluated using above reflow soldering conditions. No additional test is performed exceed the condition (i.e. the condition more than max(\*) values) as a evaluation. Please perform reflow soldering under the above conditions.
- Perform the first reflow soldering in accordance with the above temperature profile and within 168 hours of opening the package.
- Second time reflow  
In case of second reflow soldering should be performed within 168 hours of the first reflow under the above conditions.  
Storage conditions before the second reflow soldering: 5 to 30°C, 70% RH max
- Do not perform flow soldering and dip soldering.
- Make any necessary soldering corrections manually.  
(only once at each soldering point)  
Soldering iron: Less than 25 W  
Temperature: Less than 350°C or less  
Time: within 3 s (Up to one time per place)

**Recommended soldering pattern**

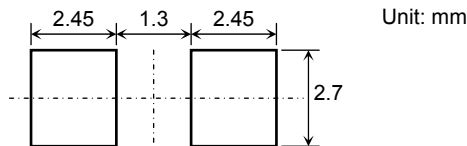

**Cleaning**

When cleaning is required after soldering, Toshiba recommends the following cleaning solvents. Our dipping tests (carried out under the recommended conditions) confirm that these solvents have no effect on semiconductor devices. In selecting the cleaning solvent you will actually use, be sure to take into account the cleaning conditions and usage conditions.

*Cleaning Solvent*

ASAHI CLEAN AK-225AES  
 KAO CLEAN THROUGH 750H  
 PINE ALPHA ST-100S

*Manufacturer*

ASAHI GLASS  
 KAO  
 ARAKAWA CHEMICAL

**Precautions When Mounting**

Do not apply force to plastic parts of the LED under high-temperature conditions.  
 The LED plastic is easily scratched. Avoid friction between plastic parts and hard objects or materials.  
 When installing the PCB in a product, ensure that the device does not come into contact with other components.  
 This product doesn't apply mounting that solder flow. Please mount on recommended reflow solder mounting condition.

**Tape Specifications**

**1. Product number format**

The type of package used for shipment is denoted by a symbol suffix after the product number. The method of classification is as below. (This method, however, does not apply to products whose electrical characteristics differ from standard Toshiba specifications.)

- (1) Tape Type: T20 (8-mm pitch)
- (2) Example

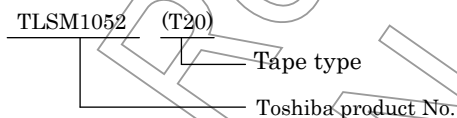

**2. Handling precautions**

Tape material protected against static electricity. However, static electricity may occur depending on quantity of charged static electricity and a device may attach to a tape, or a device may be unstable when peeling a tape cover.

- (a) In process, taping materials may sustain an electrostatic charge, use an ionizer to neutralize the ions.
- (b) For transport and temporary storage of devices, use containers (boxes, jigs, and bags) that are made of anti-static materials or of materials that dissipate electrostatic electricity.

**3. Tape dimensions**

(Unit: mm)

Symbol	Dimension	Tolerance
D	1.5	+0.1/-0
E	1.75	±0.1
P <sub>0</sub>	4.0	±0.1
t	0.4	±0.05
F	5.5	±0.05
D <sub>1</sub>	1.6	±0.1

Symbol	Dimension	Tolerance
P <sub>2</sub>	2.0	±0.05
W	12.0	±0.2
P	8.0	±0.1
A <sub>0</sub>	5.5	±0.1
B <sub>0</sub>	5.5	±0.1
K <sub>0</sub>	4.4	±0.1

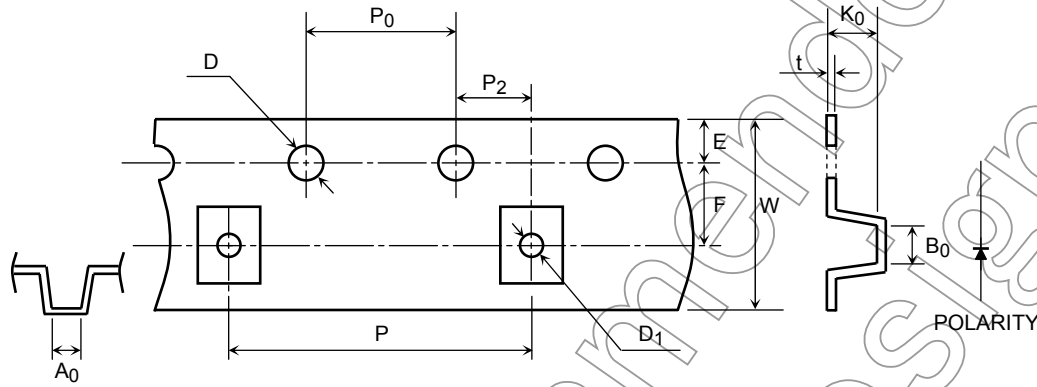

Not Recommended for New Design

**4. Reel dimensions**

Unit: mm

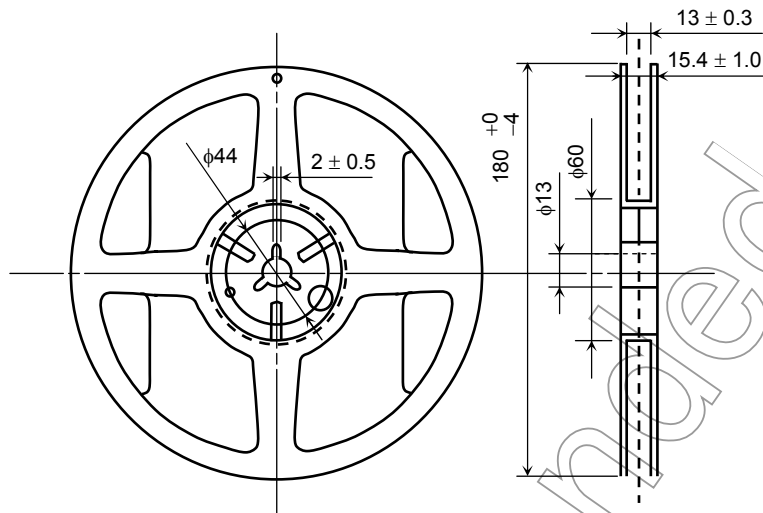

**5. Leader and trailer section of tape**

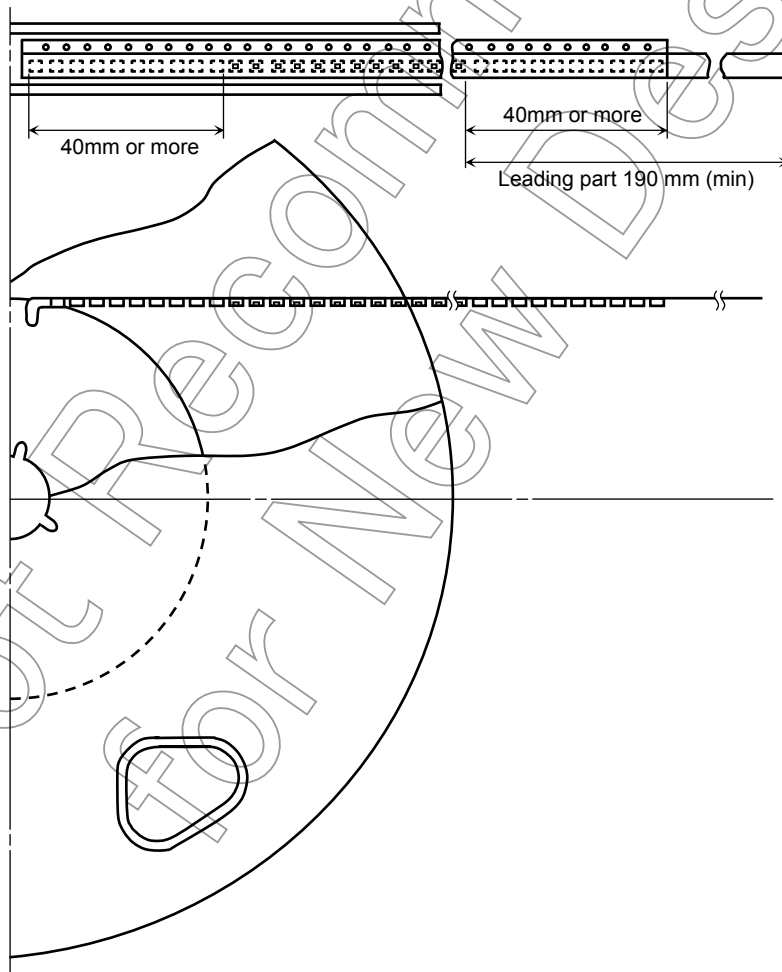

## 6. Packing form

(1) Packing quantity

Reel	400 pcs
Carton	2,000 pcs

(2) Packing form: Each reel is sealed in an aluminum pack with silica gel.

## 7. Label format

(1) Example: TL~~SM~~1052 (T20)

P/N:



TYPE	<b>TL<del>SM</del>1052</b>		
ADDC	(T20)	Q'TY	400 pcs

Lot Number    Key code for TSB    32C    400  
(RANK SYMBOL)

Use under 5-30degC/70%RH within 168h

[[G]]/RoHS COMPATIBLE  
\*Y380xxxxxxxxxxxxxxxxxxx\*

SEALING INFORMATION:  
SEALING    \*\*\*\*\*  
DIFFUSED IN    \*\*\*\*\*  
ASSEMBLED IN    \*\*\*\*\*

(2) Label location

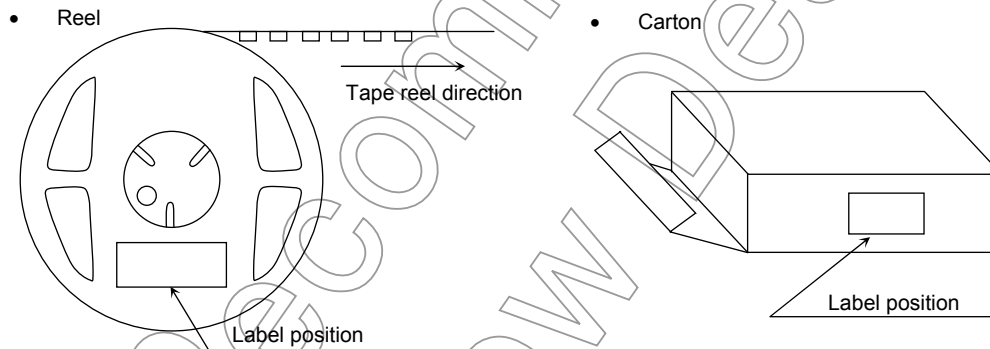

- The aluminum package in which the reel is supplied also has a copy of the label attached to the center of one side.

\*The Lot Number includes the following information.

Example: 270 9 D 3 G → "Packaged April 27, 2009"

a b c d e

a: Domestic ID

b: Last digit of the year (CE): "0" (Y2000), "1" (Y2001), "2" (Y2002) to "9" (Y2009)

Repeated for each decade

c: Month: "A" (Jan), "B" (Feb), "C" (Mar) to "L" (Dec)

d: Decade of the month: "1" (First), "2" (Middle), "3" (Last)

e: Day in d above: "A" (1st), "B" (2nd), "C" (3rd) to "J" (9th), "K" (10th)

"L" denotes the 31st of the month

"I" is not used to denote a day in this date system

**RESTRICTIONS ON PRODUCT USE**

- Toshiba Corporation, and its subsidiaries and affiliates (collectively "TOSHIBA"), reserve the right to make changes to the information in this document, and related hardware, software and systems (collectively "Product") without notice.
- This document and any information herein may not be reproduced without prior written permission from TOSHIBA. Even with TOSHIBA's written permission, reproduction is permissible only if reproduction is without alteration/omission.
- Though TOSHIBA works continually to improve Product's quality and reliability, Product can malfunction or fail. Customers are responsible for complying with safety standards and for providing adequate designs and safeguards for their hardware, software and systems which minimize risk and avoid situations in which a malfunction or failure of Product could cause loss of human life, bodily injury or damage to property, including data loss or corruption. Before creating and producing designs and using, customers must also refer to and comply with (a) the latest versions of all relevant TOSHIBA information, including without limitation, this document, the specifications, the data sheets and application notes for Product and the precautions and conditions set forth in the "TOSHIBA Semiconductor Reliability Handbook" and (b) the instructions for the application that Product will be used with or for. Customers are solely responsible for all aspects of their own product design or applications, including but not limited to (a) determining the appropriateness of the use of this Product in such design or applications; (b) evaluating and determining the applicability of any information contained in this document, or in charts, diagrams, programs, algorithms, sample application circuits, or any other referenced documents; and (c) validating all operating parameters for such designs and applications. **TOSHIBA ASSUMES NO LIABILITY FOR CUSTOMERS' PRODUCT DESIGN OR APPLICATIONS.**
- Product is intended for use in general electronics applications (e.g., computers, personal equipment, office equipment, measuring equipment, industrial robots and home electronics appliances) or for specific applications as expressly stated in this document. Product is neither intended nor warranted for use in equipment or systems that require extraordinarily high levels of quality and/or reliability and/or a malfunction or failure of which may cause loss of human life, bodily injury, serious property damage or serious public impact ("Unintended Use"). Unintended Use includes, without limitation, equipment used in nuclear facilities, equipment used in the aerospace industry, medical equipment, equipment used for automobiles, trains, ships and other transportation, traffic signaling equipment, equipment used to control combustions or explosions, safety devices, elevators and escalators, devices related to electric power, and equipment used in finance-related fields. Do not use Product for Unintended Use unless specifically permitted in this document.
- Do not disassemble, analyze, reverse-engineer, alter, modify, translate or copy Product, whether in whole or in part.
- Product shall not be used for or incorporated into any products or systems whose manufacture, use, or sale is prohibited under any applicable laws or regulations.
- The information contained herein is presented only as guidance for Product use. No responsibility is assumed by TOSHIBA for any infringement of patents or any other intellectual property rights of third parties that may result from the use of Product. No license to any intellectual property right is granted by this document, whether express or implied, by estoppel or otherwise.
- **ABSENT A WRITTEN SIGNED AGREEMENT, EXCEPT AS PROVIDED IN THE RELEVANT TERMS AND CONDITIONS OF SALE FOR PRODUCT, AND TO THE MAXIMUM EXTENT ALLOWABLE BY LAW, TOSHIBA (1) ASSUMES NO LIABILITY WHATSOEVER, INCLUDING WITHOUT LIMITATION, INDIRECT, CONSEQUENTIAL, SPECIAL, OR INCIDENTAL DAMAGES OR LOSS, INCLUDING WITHOUT LIMITATION, LOSS OF PROFITS, LOSS OF OPPORTUNITIES, BUSINESS INTERRUPTION AND LOSS OF DATA, AND (2) DISCLAIMS ANY AND ALL EXPRESS OR IMPLIED WARRANTIES AND CONDITIONS RELATED TO SALE, USE OF PRODUCT, OR INFORMATION, INCLUDING WARRANTIES OR CONDITIONS OF MERCHANTABILITY, FITNESS FOR A PARTICULAR PURPOSE, ACCURACY OF INFORMATION, OR NONINFRINGEMENT.**
- Do not use or otherwise make available Product or related software or technology for any military purposes, including without limitation, for the design, development, use, stockpiling or manufacturing of nuclear, chemical, or biological weapons or missile technology products (mass destruction weapons). Product and related software and technology may be controlled under the Japanese Foreign Exchange and Foreign Trade Law and the U.S. Export Administration Regulations. Export and re-export of Product or related software or technology are strictly prohibited except in compliance with all applicable export laws and regulations.
- Please contact your TOSHIBA sales representative for details as to environmental matters such as the RoHS compatibility of Product. Please use Product in compliance with all applicable laws and regulations that regulate the inclusion or use of controlled substances, including without limitation, the EU RoHS Directive. TOSHIBA assumes no liability for damages or losses occurring as a result of noncompliance with applicable laws and regulations.