

Power MOSFET Thermal Design and Attachment of a Thermal Fin

Description

This document explains of power MOSFETs' thermal design and attachment of a thermal fin.

Table of Contents

Description.....	1
Table of Contents.....	2
1. Thermal Design and Attachment of a Thermal Fin.....	3
1.1. Maximum Allowable Power Dissipation and Radiation Equivalent Circuit.....	3
1.2. Pulse Response of Channel Temperature.....	4
1.3. Attaching to the Heat Sink.....	11
RESTRICTIONS ON PRODUCT USE.....	13

1. Thermal Design and Attachment of a Thermal Fin

1.1. Maximum Allowable Power Dissipation and Radiation Equivalent Circuit

At thermal equilibrium, the maximum power dissipation $P_D(\max)$ of a power MOSFET can be expressed as follows in terms of the ambient temperature, T_a , the power MOSFET's maximum channel temperature $T_{ch}(\max)$ and the channel-to-ambient thermal resistance $R_{th(ch-a)}$ as determined by heat dissipation conditions discussed in this section.

$$P_D(\max)(T_a) = \frac{T_{ch}(\max) - T_a}{R_{th(ch-a)}} \quad \dots (1)$$

Heat flow can be modeled by analogy to an electrical circuit. Using this model, the heat flow from the channel of a MOSFET to the ambient air is derived from thermal resistances and thermal capacitances.

Figure 1.1 shows a radiation equivalent circuit in the thermal steady state.

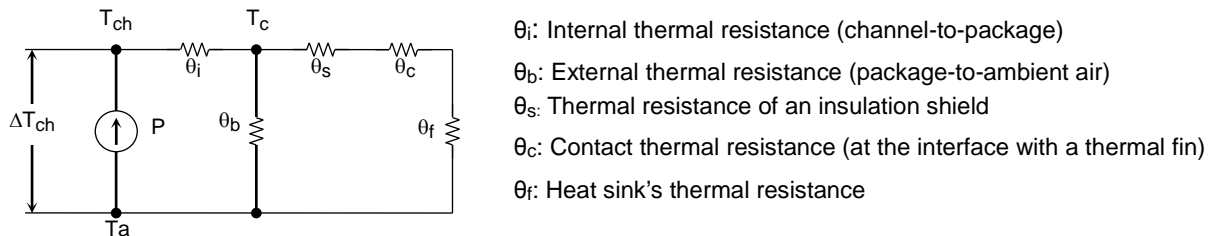

Figure 1.1 Radiation Equivalent Circuit

From the equivalent circuit of Figure 1.1, the channel-to-ambient thermal resistance $R_{th(ch-a)}$ can be calculated as follows:

$$R_{th(ch-a)} = \theta_i + \frac{\theta_b(\theta_s + \theta_c + \theta_f)}{\theta_b + \theta_s + \theta_c + \theta_f} \quad \dots (2)$$

Since no heat sink is generally used for power MOSFETs in a thermally conductive package $R_{th(ch-a)}$ can be calculated as follows:

$$R_{th(ch-a)} = \theta_i + \theta_b \quad \dots (3)$$

The catalog of power MOSFETs in thermally conductive packages shows their maximum allowable power dissipation at an ambient temperature T_a of 25°C. When this power dissipation value is not specified, the $P_D(\max)$ value can be expressed in terms of $R_{th(ch-a)}$ and $T_{ch}(\max)$:

$$P_D(\max)(T_a = 25^\circ\text{C}) = \frac{T_{ch}(\max) - 25}{R_{th(ch-a)}}$$

The case-to-ambient thermal resistance θ_b varies with the material and shape of the case. Generally, θ_b is significantly larger than θ_i , θ_c , θ_s and θ_f . Therefore, in practice, Equation (2) can be simplified as follows for packages to which a heat sink is attached:

$$R_{th(ch-a)} = \theta_i + \theta_s + \theta_c + \theta_f \quad \dots (4)$$

In dealing with direct current dissipation, it is possible to realize a radiation design satisfying the maximum given by Equation (4). When power MOSFETs are used in a pulse circuit, great care is required to ensure that the peak value of T_{ch} does not exceed $T_{ch(max)}$.

1.2. Pulse Response of Channel Temperature

Generally, the thermal impedance of a power MOSFET is modeled as a distributed constant circuit as shown in Figure 1.2.

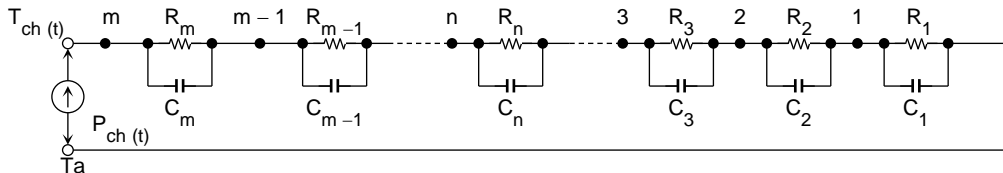

Figure 1.2 Thermal Impedance of a Power MOSFET

When a power loss $P_{ch}(t)$ shown in Figure 1.3 is applied to the circuit in Figure 1.2, the change in temperature $T_{ch}(t)$ that appears at the m -th parallel RC circuit under stable thermal conditions can be calculated as follows:

1. In the region where $P_{ch}(t) = P_0$,

$$T_{ch}(t) = \sum_{n=1}^m (P_0 R_n - T_n(min)) \left\{ 1 - \exp\left(-\frac{t}{C_n R_n}\right) \right\} + T_n(min) \quad \dots (5)$$

2. In the region where $P_{ch}(t) = 0$

$$T_{ch}(t) = \sum_{n=1}^m T_n(max) \cdot \exp\left(-\frac{t}{C_n R_n}\right) \quad \dots (6)$$

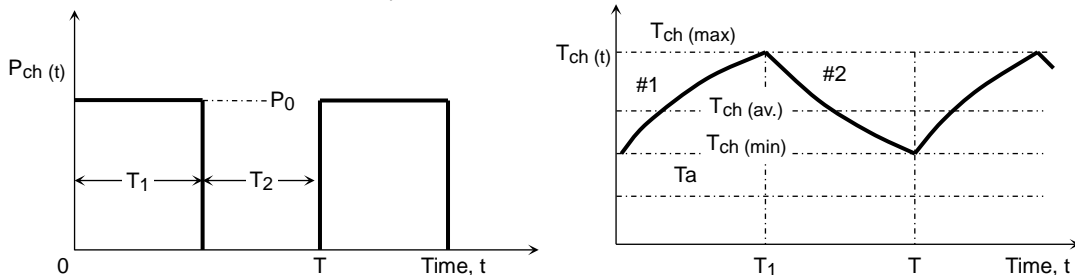

Figure 1.3 Change in Temperature Caused by Applying Pulse

For typical power MOSFETs, the actual value of $T_{ch}(t)$ can be approximated by substituting $n=4$. But if the C and R values are indefinite, it is difficult to calculate T_{ch} . Therefore, T_{chpeak} is generally estimated using transient thermal resistance as follows.

Figure 1.4 shows an example of typical transient thermal resistance characteristics. Suppose that a single rectangular pulse (with a pulse width of T_1 and a peak power loss of P_0) is applied. From the figure, we read the transient thermal resistance at a pulse width of T_1 , $r_{th}(T_1)$, and then use Equation (7) to calculate T_{chpeak} .

$$T_{chpeak} = r_{th}(T_1) \cdot P_0 + T_a \quad (7)$$

When a repetitive pulse train with a cyclic period of T is applied as shown in Figure 1.3, T_{chpeak} in a thermally stable state is calculated as follows:

$$T_{chpeak} = P_0 \left[\frac{T_1}{T} R_{th(ch-a)} + \left(1 - \frac{T_1}{T} \right) \cdot r_{th}(T + T_1) - r_{th}(T) + r_{th}(T_1) \right] + T_a \quad \dots (8)$$

Great care should be exercised in the thermal design for a pulse circuit to ensure that T_{chpeak} does not exceed $T_{ch(max)}$ of a power MOSFET.

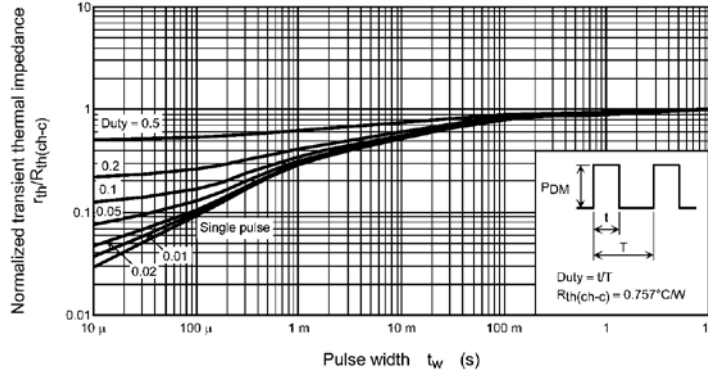

Figure 1.4. Transient Thermal Resistance Curves

In practice, $P_{ch}(t)$ may not be a rectangular wave for applications of power MOSFETs. In such cases, approximate the power loss waveform as a rectangular wave as shown in Figure 1.5 and use Equation (8) to estimate T_{chpeak} .

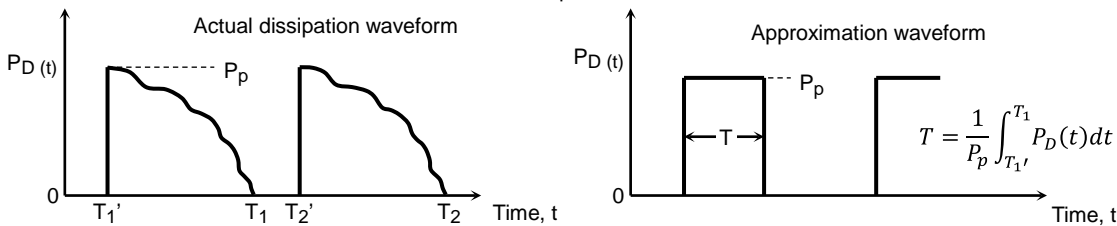

Figure 1.5 Approximation of a Power Loss Waveform

In order to accurately convert a power loss wave into a square wave, it is necessary to perform integration. However, if the power loss waveform is nearly a sine-wave or triangular-wave $P_{ch}(t)$ can be estimated as shown below.

In (a) and (b), a peak value of $0.7P_D$ and a pulse width of either $0.91t$ or $0.71t$ are assumed (to obtain a square pulse with the same area).

In (c) and (d), the peak value is the same before and after conversion, the pulse width is approximated as $0.63t$ or $t/2$ (to obtain a square pulse with the same area).

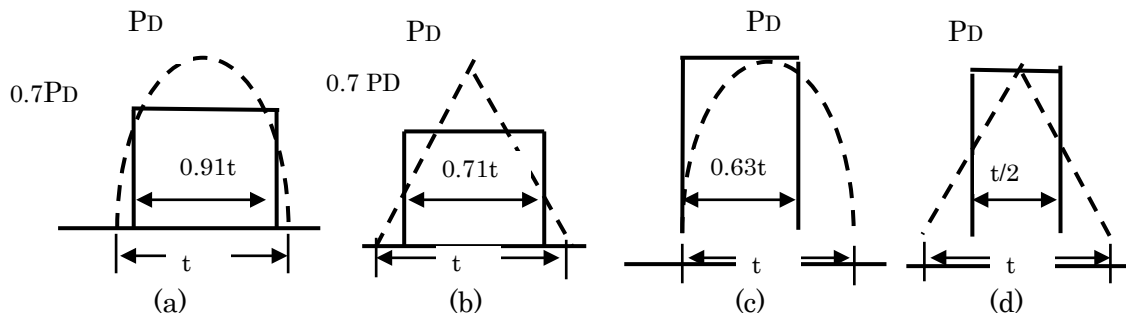
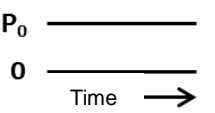

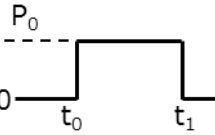
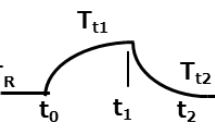
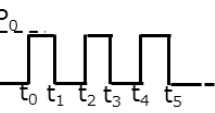
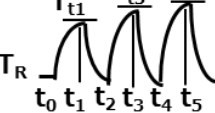
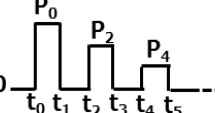

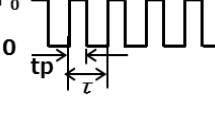
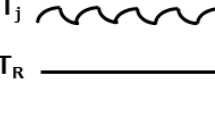
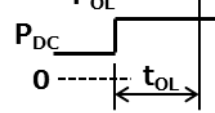
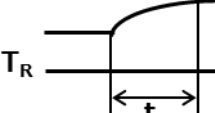
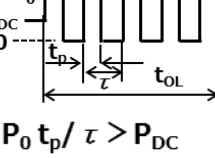
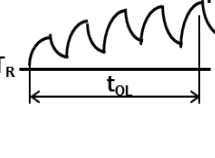

Figure 1.6 Waveform Approximation

Table 1.1 Basic Equations for Calculating Load Current

Power Applying Pattern	Junction Power Loss Waveform	Junction Temperature Rise (T_R : Reference temperature)	Junction Temperature and Power Loss R_{th} = Steady-state Thermal Resistance $r_{th}(t_1)$ = Transient Thermal Impedance at Time t_1 $r_{th}(t_2-t_1)$ = Transient Thermal Impedance at Time (t_2-t_1)
(a) Continuous load			$T_j - T_R = P_0 R_{th}$ $P_0 = (T_j - T_R) / R_{th}$
(b) Single-shot pulse			$T_{t1} - T_R = P_0 r_{th}(t_1)$ $T_{t2} - T_R = P_0 [r_{th}(t_2) - r_{th}(t_2-t_1)]$ $P_0 = (T_{t1} - T_R) / r_{th}(t_1)$
(c) Short pulse train with an equal amplitude			$T_{t1} - T_R = P_0 r_{th}(t_1)$ $T_{t3} - T_R = P_0 [r_{th}(t_3) - r_{th}(t_3-t_1) + r_{th}(t_3-t_2)]$ $T_{t5} - T_R = P_0 [r_{th}(t_5) - r_{th}(t_5-t_1) + r_{th}(t_5-t_2) - r_{th}(t_5-t_3) + r_{th}(t_5-t_4)]$
(d) Pulse train with an unequal amplitude			$T_{t1} - T_R = P_0 r_{th}(t_1)$ $T_{t3} - T_R = P_0 r_{th}(t_3) - P_0 r_{th}(t_3-t_1) + P_2 r_{th}(t_3-t_2)$ $T_{t5} - T_R = P_0 r_{th}(t_5) - P_0 r_{th}(t_5-t_1) + P_2 r_{th}(t_5-t_2) - P_2 r_{th}(t_5-t_3) + P_4 r_{th}(t_5-t_4)$
(e) Long pulse train with an equal amplitude (approximate solution)			$T_j - T_R = P_0 [(t_p R_{th} / \tau) + (1 - t_p / \tau) r_{th}(\tau + t_p) - r_{th}(\tau) + r_{th}(t_p)]$ $P_0 = (T_j - T_R) / [(t_p R_{th} / \tau) + (1 - t_p / \tau) r_{th}(\tau + t_p) - r_{th}(\tau) + r_{th}(t_p)]$
(f) Overload with continuous load (Non-pulsed)			$T_{tOL} - T_R = P_{DC} R_{th} + (P_{OL} - P_{DC}) r_{th}(t_{OL})$ $P_{OL} = [(T_{tOL} - T_R - P_{DC} R_{th}) / r_{th}(t_{OL})] + P_{DC}$
(g) Overload with continuous load (Pulsed) (Approximate solution)			$T_{OL} - T_R = P_{DC} R_{th} + P_0 [(t_p / \tau - P_{DC} / P_0) r_{th}(t_{OL}) + (1 - t_p / \tau) r_{th}(\tau + t_p) - r_{th}(\tau) + r_{th}(t_p)]$ $P_0 = [T_{OL} - T_R - P_{DC} \{R_{th} - r_{th}(t_{OL})\}] / [(t_p / \tau) r_{th}(t_{OL}) + (1 - t_p / \tau) r_{th}(\tau + t_p) - r_{th}(\tau) + r_{th}(t_p)]$

Calculation Example:

The data necessary for calculation are the waveforms of drain-source voltage and the drain current, the ambient temperature, the thermal resistance data for the heat sink, and the operating conditions. Channel temperature can be estimated with Equation (8) using these data. If the result is less than the rated maximum channel temperature $T_{ch(max)}$, you can determine that the device can be used.

Here is an example of calculation based on a typical waveform under continuous operation for switching power supplies.

Typical waveform: Device without a heat sink

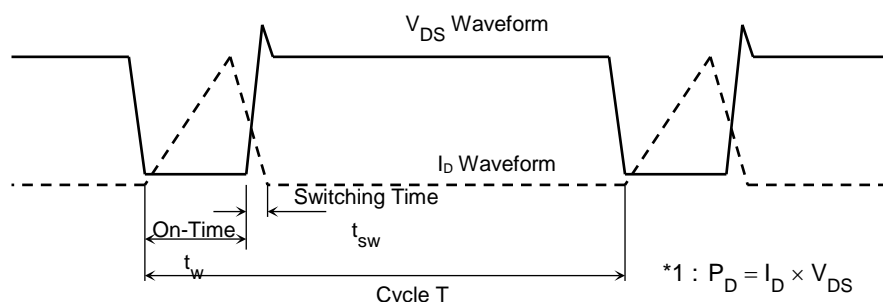

Figure 1.7 Typical Waveform

First, approximate the power loss^{*1} from the above waveform as a square wave and then use Equation (8) to calculate the channel temperature. Figure 1.8 shows the waveform for power loss and the square waveform approximated from it.

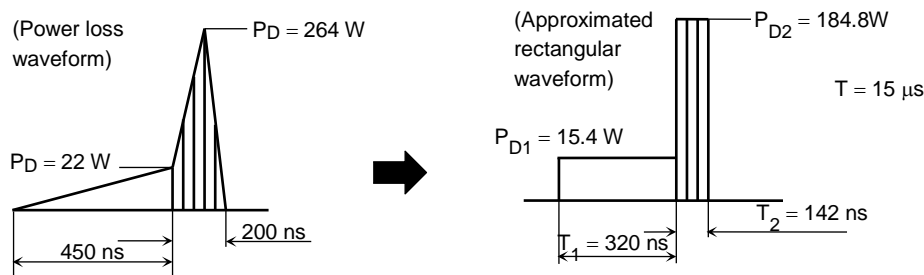

Figure 1.8 Approximated Rectangular Waveform

If a regularly repetitive rectangular waveform as shown in Figure 1.3 is applied to a device, Equation (8) can be used to calculate the peak of the channel temperature increase. If multiple rectangular waveforms mentioned above are periodically applied, it is necessary to create a separate model and apply the equation to that model.

Create a model by combining an average power loss with two or so cycles in which the power loss exceeds the average. For the above rectangular waveform, use the following type of approximate model shown in Figure 1.9 for calculation.

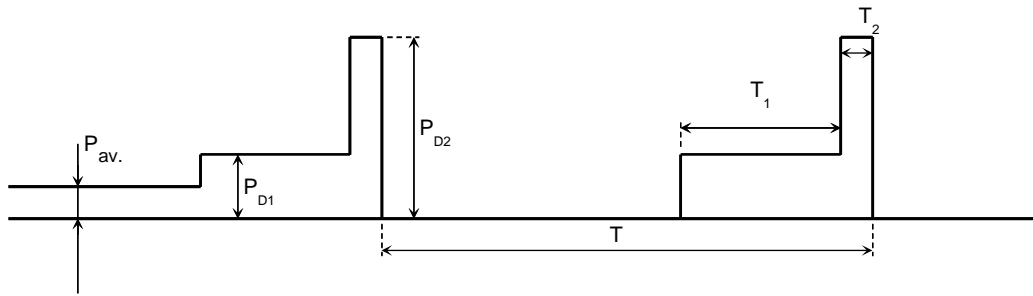

Figure 1.9 Power Loss Model

$$P_{av.} = \frac{1}{T} \int_0^T (P_{D1} + P_{D2}) dt = \frac{1}{T} (T_1 P_{D1} + T_2 P_{D2})$$

Calculate as given below; the average power loss is applied for an infinite period $P_{av.}$ (#1) and the repetitive waveform is applied for two cycles thereafter.

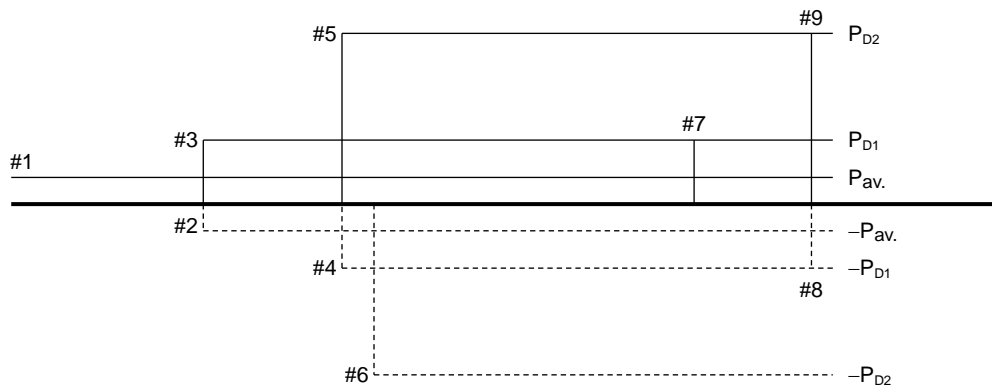

Figure 1.10 Relationship of Stacked Waveforms and Time

$$\begin{aligned} \Delta T_{ch(peak)} = & \underbrace{P_{av.}}_{\#1} \times R_{th(ch-a)} - \underbrace{P_{av.}}_{\#2} \times r_{th}(T + T_1 + T_2) + \underbrace{P_{D1}}_{\#3} \times r_{th}(T + T_1 + T_2) \\ & - \underbrace{P_{D1}}_{\#4} \times r_{th}(T + T_2) + \underbrace{P_{D2}}_{\#5} \times r_{th}(T + T_2) - \underbrace{P_{D2}}_{\#6} \times r_{th}(T) + \underbrace{P_{D1}}_{\#7} \times r_{th}(T_1 + T_2) \\ & - \underbrace{P_{D1}}_{\#8} \times r_{th}(T_2) + \underbrace{P_{D2}}_{\#9} \times r_{th}(T_2) \quad \dots (9) \end{aligned}$$

To calculate channel temperature, the $R_{th(ch-a)}$ and $r_{th}(t)$ values are necessary as shown in Equation (9).

$r_{th}(t)$: Obtain from the transient thermal resistance curves provided in individual technical datasheets.

If the pulse width is shorter than the range shown in the datasheet, calculate as follows:

$$r_{th}(t) = r_{th}(T) \times \sqrt{\frac{t}{T}}$$

T: Shortest period of time shown in the transient thermal resistance curve

$r_{th}(T)$: transient thermal resistance at time T

The thermal resistance values shown in the equivalent thermal circuit of Figure 1.1 can be explained as follows:

- (1) Channel-to-case thermal resistance (internal thermal resistance): θ_i

The internal thermal resistance θ_i from the channel of a power MOSFET to the case depends on the structure and materials of the MOSFET, board assembly, case materials and other factors. Each power MOSFET has its own thermal resistance characteristics. To measure internal thermal resistance, the case of the power MOSFET must be cooled to maintain a constant temperature.

When the case temperature T_c is held at 25°C, the maximum allowable power dissipation, $P_D(\max)$, of a power MOSFET can be calculated using Equation (10).

$$P_D(\max) = \frac{T_{ch(\max)} - T_c}{\theta_i} = \frac{T_{ch(\max)} - 25}{\theta_i} \quad \dots(10)$$

In catalogs for power MOSFET, the maximum allowable drain dissipation is specified at a temperature of 25°C with specific condition in datasheets.

Note: The symbol $R_{th(ch-c)}$ may be used to represent channel-to-case thermal resistance.

- (2) Contact thermal resistance: θ_c

Contact thermal resistance θ_c varies according to the condition of the contact surface between the case of the power MOSFET and the heat sink. This condition is greatly affected by factors such as the coarseness and the fastening method. For example, the influence of factors such as coarseness and unevenness can be reduced by the application of silicone grease. However, power MOSFETs (such as surface-mounted devices) are not designed to be attached directly to heat sinks, and contact thermal resistance can be considerably large in case of poor attachment to the heat sink.

- (3) Insulation plate's thermal resistance: θ_s

If it is necessary to provide electrical insulation between a power MOSFET and a heat sink, an insulation plate must be inserted between them.

The thermal resistance of this insulation plate θ_s varies with the materials, thickness and area of the plate. Sometimes the thermal resistance value of the insulation plate can be significant, so it must not be ignored.

(4) Heat sink thermal resistance: θ_f

The thermal resistance of a heat sink can be considered as the distributed thermal resistance of the heat path from the surface of a heat sink to ambient air. The thermal resistance of a heat sink is decided by its material, shape, condition of ambient, and the effective area of the heat sink.

Figure 1.11 shows an example of thermal resistance data measured for a power MOSFET standing vertically at the center of the heat sink.

In recent years, various thermal heat sinks have been available from many vendors. These data are useful when using a heat sink.

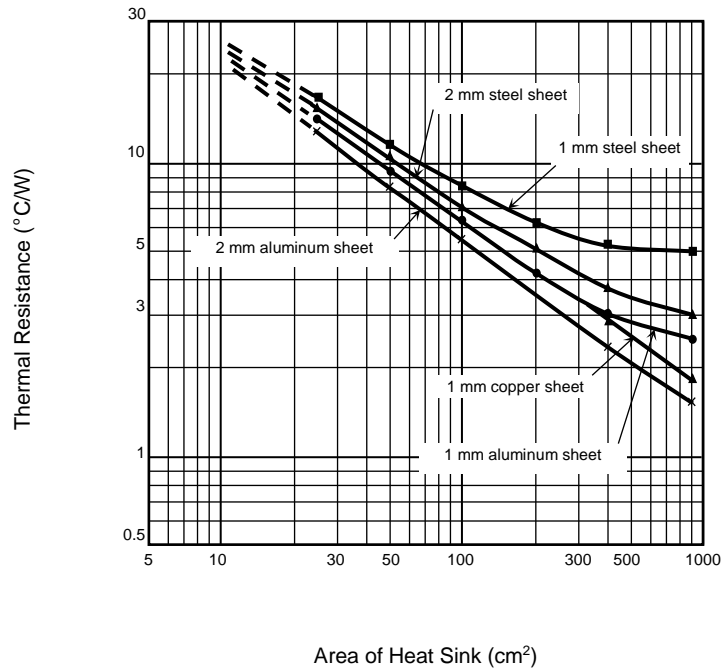

Figure 1.11 Area of Heat Sink and Thermal Resistance θ_f

1.3. Attaching to the Heat Sink

It is recommended to attach the heat sink in accordance with the following points. For example, if the heat sink has burrs or hollows, if its attachment profile is the wrong size, or the tightening torque of the MOSFET is not adequate, the MOSFET can be warped, causing the destruction of a pallet or resin, or the degradation of adhesion between the resin and the frame.

(1) Flatness of heat sink

The surface on which a device is to be attached must be sufficiently smooth. If it is warped or substantially uneven or if any foreign matter, such as pressing burrs or cutting chips, are present, the device could be destroyed in the worst case. To prevent this problem, the flatness of the surface where the device is attached should be 50 μm or less.

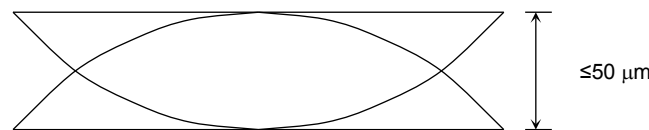

Figure 1.12 Warp of Heat Sink

(2) Mounting hole

Intrusion around the mounting holes resulting from machining should be 50 μm or less in size, and the mounting holes should not be unnecessarily large. If such conditions are unavoidable, be sure to insert a square washer.

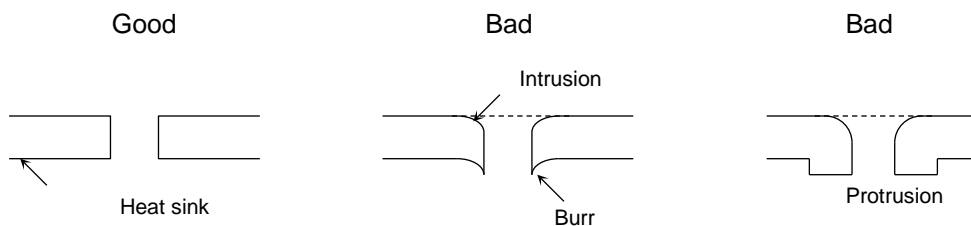

Figure 1.13 Burrs, Intrusion and Protrusion on Mounting Holes

(3) Screws

Screws used to attach MOSFETs to a heat sink are generally classified as machine screws and tapping screws. When tapping screws are used, care should be exercised to ensure that the tightening torque will not exceed the maximum allowable limit. Do not use special screws such as flat-head and round-head screws because they apply excessive stress on the device.

(4) Insulation spacers

Use insulation spacers with sufficient mechanical strength.

(5) Insulation washers

Use insulation washers suitable for the device.

(6) Grease

Use grease that is not prone to base oil separation so that the device is not adversely affected internally.

(7) Tightening torques

The tightening torques should be less than the values shown in Table 1.2 so as not to cause stress on the device and to achieve the desired thermal resistance.

Table 1.2 Maximum Torques by Packages

Package	Screw Tightening Torque (max)(in N·m)
Name	
TO-220	0.6
TO-220SIS	0.6
TO-3P(N)	0.8
TO-247	0.8
TO-3P(L)	0.8

RESTRICTIONS ON PRODUCT USE

Toshiba Corporation and its subsidiaries and affiliates are collectively referred to as "TOSHIBA". Hardware, software and systems described in this document are collectively referred to as "Product".

- TOSHIBA reserves the right to make changes to the information in this document and related Product without notice.
- This document and any information herein may not be reproduced without prior written permission from TOSHIBA. Even with TOSHIBA's written permission, reproduction is permissible only if reproduction is without alteration/omission.
- Though TOSHIBA works continually to improve Product's quality and reliability, Product can malfunction or fail. Customers are responsible for complying with safety standards and for providing adequate designs and safeguards for their hardware, software and systems which minimize risk and avoid situations in which a malfunction or failure of Product could cause loss of human life, bodily injury or damage to property, including data loss or corruption. Before customers use the Product, create designs including the Product, or incorporate the Product into their own applications, customers must also refer to and comply with (a) the latest versions of all relevant TOSHIBA information, including without limitation, this document, the specifications, the data sheets and application notes for Product and the precautions and conditions set forth in the "TOSHIBA Semiconductor Reliability Handbook" and (b) the instructions for the application with which the Product will be used with or for. Customers are solely responsible for all aspects of their own product design or applications, including but not limited to (a) determining the appropriateness of the use of this Product in such design or applications; (b) evaluating and determining the applicability of any information contained in this document, or in charts, diagrams, programs, algorithms, sample application circuits, or any other referenced documents; and (c) validating all operating parameters for such designs and applications. **TOSHIBA ASSUMES NO LIABILITY FOR CUSTOMERS' PRODUCT DESIGN OR APPLICATIONS.**
- **PRODUCT IS NEITHER INTENDED NOR WARRANTED FOR USE IN EQUIPMENTS OR SYSTEMS THAT REQUIRE EXTRAORDINARILY HIGH LEVELS OF QUALITY AND/OR RELIABILITY, AND/OR A MALFUNCTION OR FAILURE OF WHICH MAY CAUSE LOSS OF HUMAN LIFE, BODILY INJURY, SERIOUS PROPERTY DAMAGE AND/OR SERIOUS PUBLIC IMPACT ("UNINTENDED USE").** Except for specific applications as expressly stated in this document, Unintended Use includes, without limitation, equipment used in nuclear facilities, equipment used in the aerospace industry, medical equipment, equipment used for automobiles, trains, ships and other transportation, traffic signaling equipment, equipment used to control combustions or explosions, safety devices, elevators and escalators, devices related to electric power, and equipment used in finance-related fields. **IF YOU USE PRODUCT FOR UNINTENDED USE, TOSHIBA ASSUMES NO LIABILITY FOR PRODUCT.** For details, please contact your TOSHIBA sales representative.
- Do not disassemble, analyze, reverse-engineer, alter, modify, translate or copy Product, whether in whole or in part.
- Product shall not be used for or incorporated into any products or systems whose manufacture, use, or sale is prohibited under any applicable laws or regulations.
- The information contained herein is presented only as guidance for Product use. No responsibility is assumed by TOSHIBA for any infringement of patents or any other intellectual property rights of third parties that may result from the use of Product. No license to any intellectual property right is granted by this document, whether express or implied, by estoppel or otherwise.
- **ABSENT A WRITTEN SIGNED AGREEMENT, EXCEPT AS PROVIDED IN THE RELEVANT TERMS AND CONDITIONS OF SALE FOR PRODUCT, AND TO THE MAXIMUM EXTENT ALLOWABLE BY LAW, TOSHIBA (1) ASSUMES NO LIABILITY WHATSOEVER, INCLUDING WITHOUT LIMITATION, INDIRECT, CONSEQUENTIAL, SPECIAL, OR INCIDENTAL DAMAGES OR LOSS, INCLUDING WITHOUT LIMITATION, LOSS OF PROFITS, LOSS OF OPPORTUNITIES, BUSINESS INTERRUPTION AND LOSS OF DATA, AND (2) DISCLAIMS ANY AND ALL EXPRESS OR IMPLIED WARRANTIES AND CONDITIONS RELATED TO SALE, USE OF PRODUCT, OR INFORMATION, INCLUDING WARRANTIES OR CONDITIONS OF MERCHANTABILITY, FITNESS FOR A PARTICULAR PURPOSE, ACCURACY OF INFORMATION, OR NONINFRINGEMENT.**
- Do not use or otherwise make available Product or related software or technology for any military purposes, including without limitation, for the design, development, use, stockpiling or manufacturing of nuclear, chemical, or biological weapons or missile technology products (mass destruction weapons). Product and related software and technology may be controlled under the applicable export laws and regulations including, without limitation, the Japanese Foreign Exchange and Foreign Trade Law and the U.S. Export Administration Regulations. Export and re-export of Product or related software or technology are strictly prohibited except in compliance with all applicable export laws and regulations.
- Please contact your TOSHIBA sales representative for details as to environmental matters such as the RoHS compatibility of Product. Please use Product in compliance with all applicable laws and regulations that regulate the inclusion or use of controlled substances, including without limitation, the EU RoHS Directive. **TOSHIBA ASSUMES NO LIABILITY FOR DAMAGES OR LOSSES OCCURRING AS A RESULT OF NONCOMPLIANCE WITH APPLICABLE LAWS AND REGULATIONS.**