

Digital-Output Magnetic Sensor (Hall IC)

Outline:

Digital output magnetic sensors (Hall ICs) are sensors used in various electronic devices that detect magnetic fields. This document describes the basic knowledge of digital output magnetic sensors, basic operation of South-pole / North-pole / South-pole and North-pole, dual detection type, output circuit types such as push-pull and open drain, and our lineup.

Table of Contents

Outline:.....	1
Table of Contents	2
1. Introduction.....	3
2. Basic principles of magnetic sensor	3
3. Application example of Magnetic sensor (South-pole detection type : TCS30SPU)	5
4. Toshiba magnetic sensor lineup.....	8
5. Other precautions.....	10
6. Related Links	11
7. RESTRICTIONS ON PRODUCT USE.....	12

1. Introduction

The digital-output magnetic sensor is essentially a sensor which detects the magnetic flux density of a magnet and gives a digital signal at the output. The digital-output magnetic sensor is thus suitable for detecting the position of a magnet which is useful for open/close switch functions and slider functions in mobile phones, notebook PC, digital camera and digital video camera, etc. This application note will introduce the basic application circuit of the digital-output magnetic sensor and what to take note of during normal operation. We hope that you will find it useful.

2. Basic principles of magnetic sensor

•Basic operating circuit

The basic operating circuit is described in Fig.1.

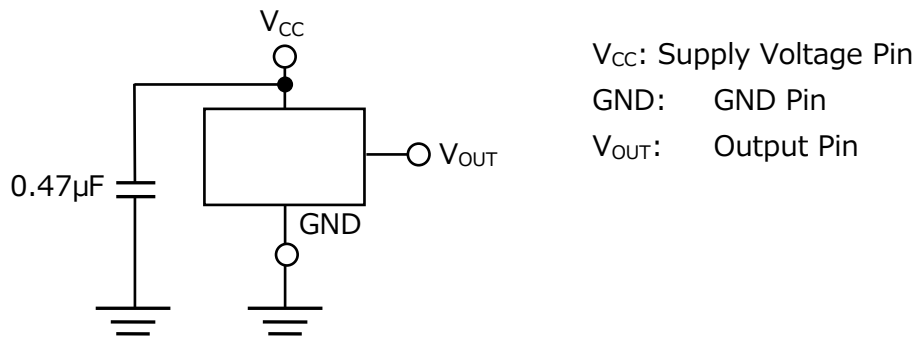

Fig.1 Basic operating circuit for Digital-output magnetic

Please use a $0.47\mu F$ capacitor near the Supply Voltage Pin, V_{CC} , for stable operation of the device.

•Internal Circuit Block diagram

Toshiba’s digital-output magnetic sensor TCS30/40xxx is a Silicon monolithic magnetic sensor (Hall IC) which detects magnetic flux using silicon hall elements. Please refer to Fig. 2 for the block diagram.

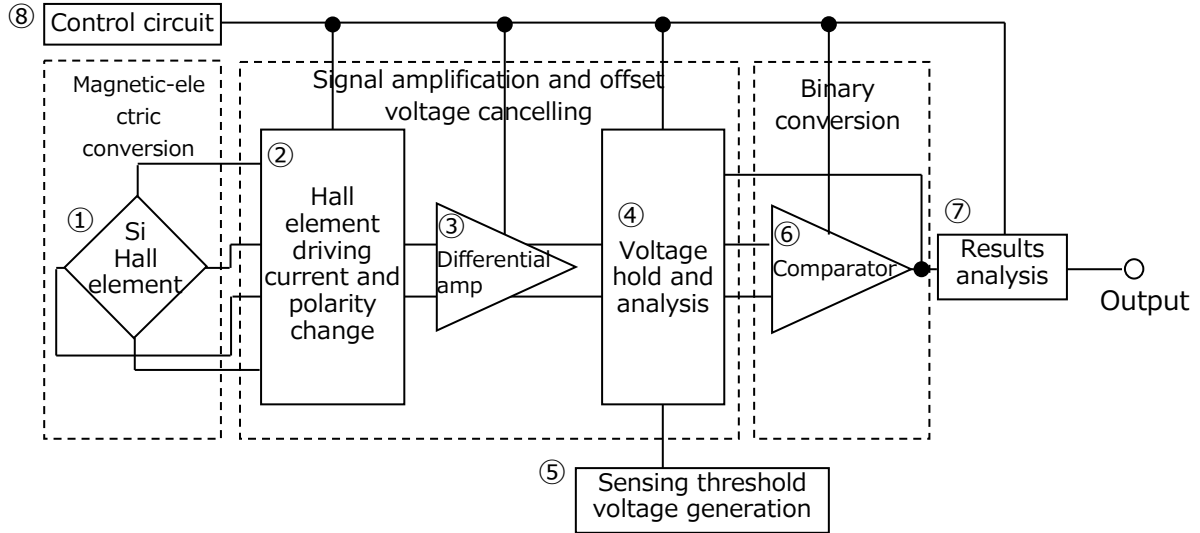

Fig.2 Digital-output magnetic sensor internal circuit block diagram

The internal circuit comprises of the following 8 circuits.

- ① Silicon hall element
- ② Switching circuit for drive current of hall elements and the difference between that and differential amp for offset cancelling used during polarity change.
- ③ Differential amp for the amplification of hall voltage V_H in the silicon hall element.
- ④ Analysis circuit and voltage hold of amplified hall voltage from the silicon hall element, differential amp and comparator offset cancelling stages.
- ⑤ Detection threshold voltage producing circuit, which produces a reference voltage used for the threshold limit for the detection of magnetic field.
- ⑥ Comparator which provides a binary output after comparing the value from the hall element with the threshold value, to determine if there is a significant magnetic field.
- ⑦ Maintain output voltage from the comparator, circuit for maintaining the detection results.
- ⑧ Control element for operation control of all circuits.

3. Application example of Magnetic sensor (South-pole detection type : TCS30SPU)

Using the South-pole detection digital-output magnetic sensor TCS30SPU as an example, Fig.3 shows the sensor and the corresponding field. In Fig.4, as the magnet is brought close to the sensor, magnetic field flows from North-pole to the South-pole as detected by the sensor.

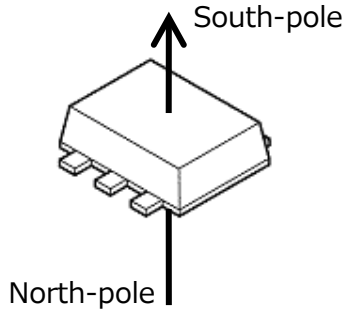

Fig.3 Package and magnetic field direction (TCS30SPU example)

Caution:
 The sensor will sense the magnetic field as shown in Fig.3. As such, if similar to bringing a South-pole to the top, bringing a North-pole close to the bottom will also result in positive output. To prevent this:

- Consider carefully magnetic sensor and magnet location
- Placing a magnetic shield on the bottom of sensor

The required magnetic field for the operation of magnetic sensor is determined by the magnetic flux density. For TCS30SPU, as the magnet is moved towards the sensor, the value required is 1.8mT(typ) and above for operating point (B_{ON}) and output voltage is switched to L level (Fig.4). As the magnet is moved away from the device and the threshold magnetic flux density is 0.8mT(typ) and below, the releasing point (B_{OFF}) and output voltage will be H level (Fig.5). As such, the hysteresis (BH) or difference between operating and releasing point flux density $| B_{ON}-B_{OFF} |$ is 1.0mT(typ) (Fig.6).

Please refer to the datasheet for the operating, releasing point and hysteresis magnetic flux density for each product.

Fig.4 Operation characteristics as the magnet is brought towards the magnetic sensor.
 (South-pole detection type TCS30SPU example)

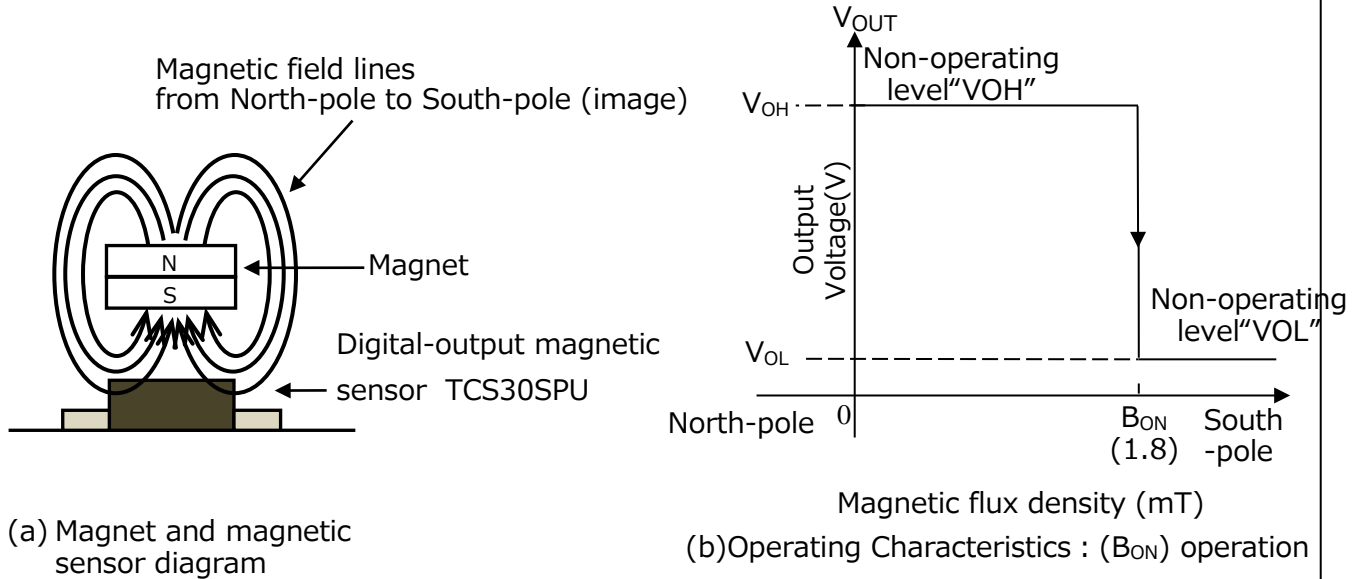
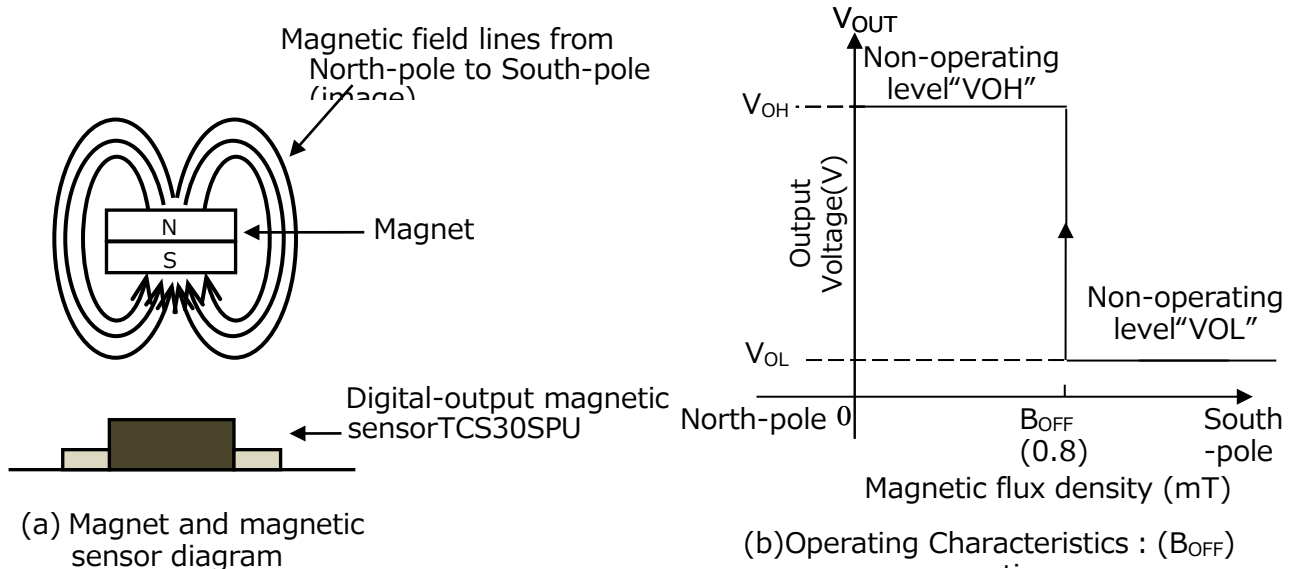
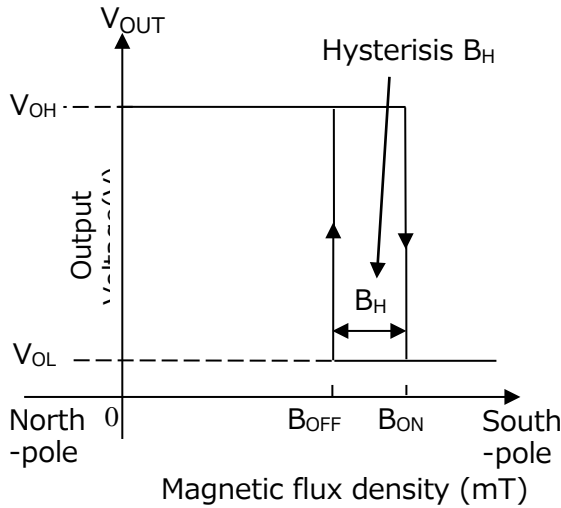

Fig.5 Operation characteristics as the magnet is brought away from the magnetic sensor.
 (South-pole detection type TCS30SPU example)





Magnetic flux density	Output
B_{ON}	V_{OL}
B_{OFF}	V_{OH}

(a) Magnetic Flux density and output voltage table

(b) Operating Characteristics

Fig.6 Magnetic flux density and output voltage relationship (South-pole detection type: TCS30SPU)

• Pulse operation to lower power consumption

Our digital-output magnetic sensor implements pulse operation (Fig.7). The operating frequency (f_{opr}) for magnet sensing is 25Hz(typ), and the power is cut-off during rest phases to reduce power consumption.

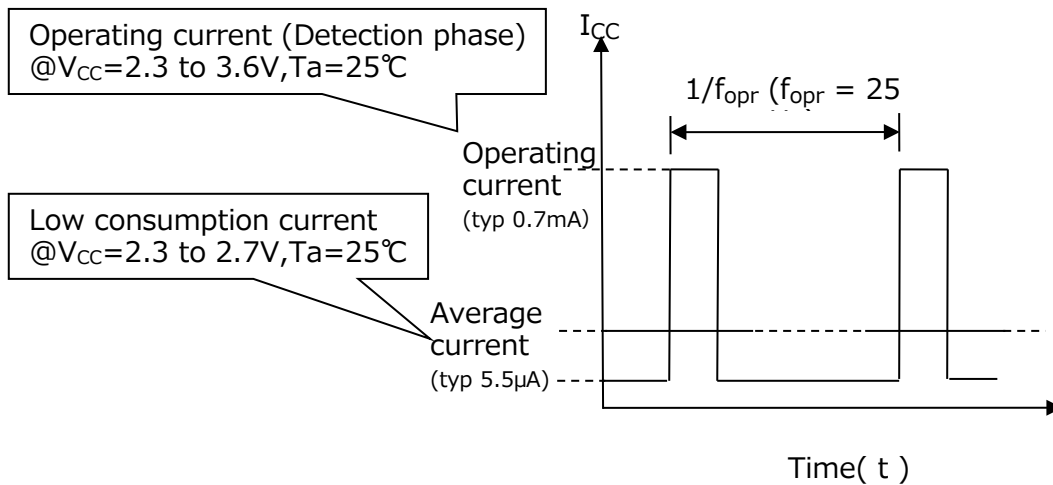

Fig.7 Pulse operation and consumption current (S-pole detection type: TCS30SPU)

Similarly, the N-pole detection type detects the magnetic field and operates the magnetic sensor when the N-pole of the magnet is brought close to the top surface of the product package.

The S-Pole and N-Pole detection type detects the magnetic field and operates the magnetic sensor when the S-pole or N-pole of the magnet is brought close to the top surface of the product package.

•Positioning of magnet sensing element

The position of the magnet sensing element is shown in Fig.8. Please align the magnet with the magnet sensing element.

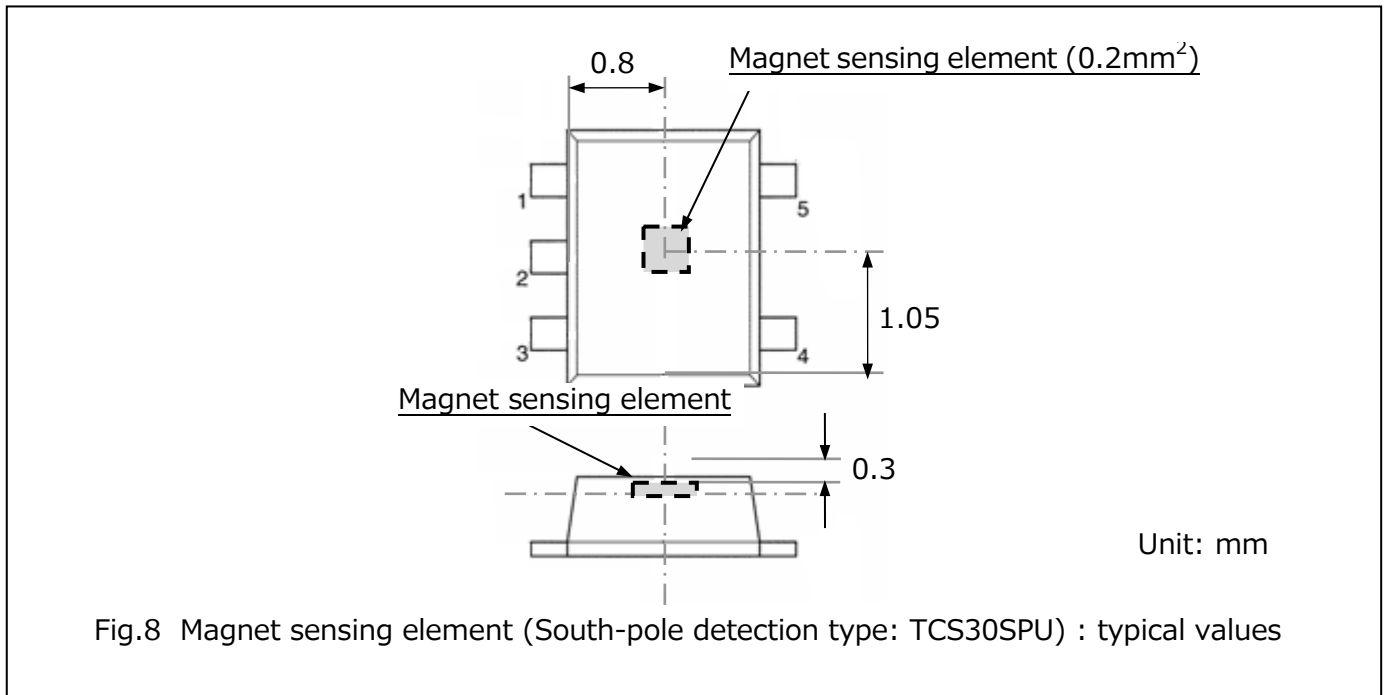

4. Toshiba magnetic sensor lineup

•Different pole detection types

There are 3 types:

- ① South-pole detection type (Fig.6 shows the magnetic operating characteristics)
- ② North-pole detection type (Fig.9 shows the magnetic operating characteristics)
- ③ South-pole and North-pole, dual detection type (Fig.10 shows the magnetic operating characteristics)

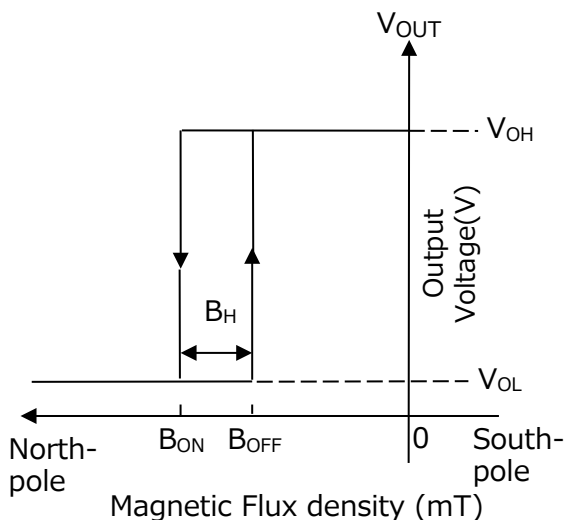

Fig.9 Magnetic operating characteristics (North-pole detection type: TCS30NPU)

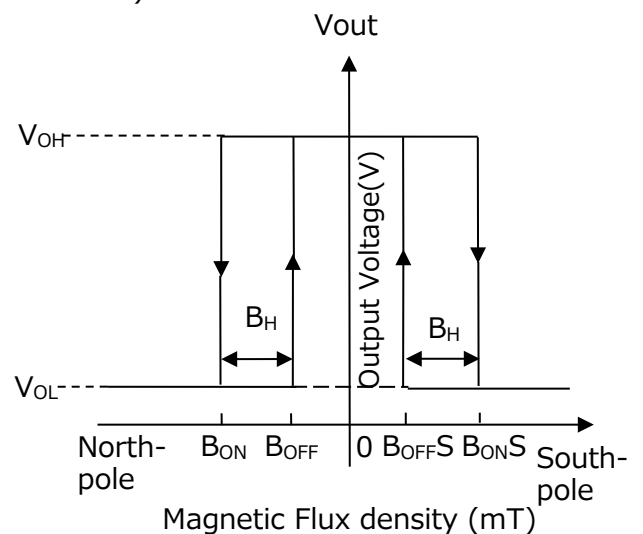

Fig.10 Magnetic operating characteristics (South/North-pole detection type: TCS30DPU)

• Different output circuit types

There are 3 output circuit types

- ① Push-pull output
- ② Open-drain output
- ③ Open-drain output with Inverted logic

① Push-pull output

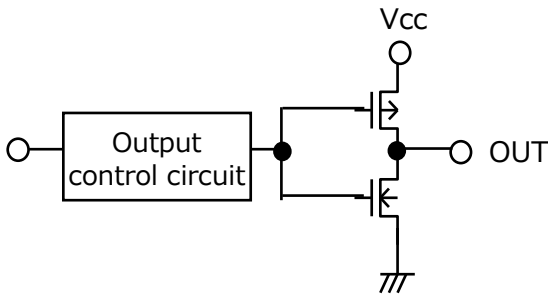

Fig.11 Push-pull output circuit

Push-pull output characteristics

- "H" output level close to V_{CC} level
- Low consumption current

Magnetic Flux density	Output logic
Above B_{ON}	L level
Below B_{OFF}	H level

② Open-drain output

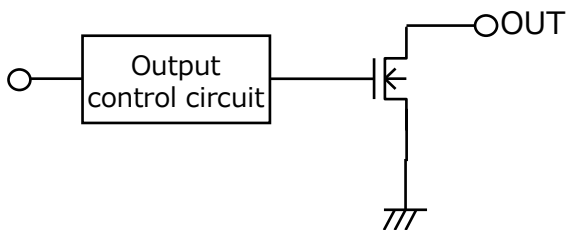

Fig.12 Open-drain output circuit

Open-drain output characteristics

- Output can be pulled-up to 5V (Variable output voltage)
- : During high impedance output

Magnetic Flux density	Output logic
Above B_{ON}	L level
Below B_{OFF}	Z (high impedance)

③ Open-drain output with Inverted logic

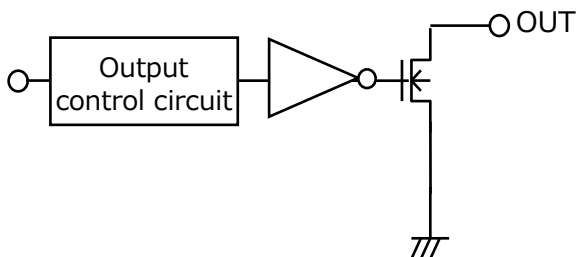







Fig.13 Open-drain with Inverted logic output circuit

Open-drain output characteristics

- For long standby time, consumption current can be reduced
- Output can be pulled-up to 5V (Variable output voltage)
- : During high impedance output

Magnetic Flux density	Output logic
Above B_{ON}	Z (high impedance)
Below B_{OFF}	L level

•Magnetic Sensors Lineup

Part Number	Detection polarity	Output Structure	Supply Voltage	BON(Typ)	BOFF(Typ)	Package	StockCheck & Purchase
TCS30DLU	Dual detection	Open drain	2.3 to 3.6V	1.8mT	0.8mT	UFV (SOT-353F)	
TCS30DPU	Dual detection	Push-pull	2.3 to 3.6V	1.8mT	0.8mT	UFV (SOT-353F)	
TCS30NPU	North-Pole Detection	Push-pull	2.3 to 3.6V	1.8 mT	0.8 mT	UFV (SOT-353F)	
TCS30SPU	South-Pole Detection	Push-pull	2.3 to 3.6V	1.8mT	0.8mT	UFV (SOT-353F)	
TCS40DLR	Dual detection	Open drain	2.3 to 5.5V	3.4mT	2.0mT	SOT-23F	
TCS40DPR	Dual detection	Push-pull	2.3 to 5.5V	3.4mT	2.0mT	SOT-23F	

•UFV (SOT-353F) Package
2.0×2.1×0.7mm



•SOT-23F Package
2.9×2.4×0.8mm



5. Other precautions

1. Please take into consideration the possible variation in the sensor characteristics and magnet, allowing some margin in your design.
2. The sensitivity of the sensor might be affected by stress on the package. Please do not apply excessive stress on the package during soldering.

6. Related Links

Click here for the product lineup of Magnetic Sensors

[Click Here](#)

■ Lineup (Parametric Search)

[Click](#)

■ Stock Check & Purchase



■ We can support magnetic simulation using our magnetic sensor according to the customer's request.

For details, please contact our sales office or our Web inquiry window.

7. RESTRICTIONS ON PRODUCT USE

Toshiba Corporation and its subsidiaries and affiliates are collectively referred to as "TOSHIBA". Hardware, software and systems described in this document are collectively referred to as "Product".

- TOSHIBA reserves the right to make changes to the information in this document and related Product without notice.
- This document and any information herein may not be reproduced without prior written permission from TOSHIBA. Even with TOSHIBA's written permission, reproduction is permissible only if reproduction is without alteration/omission.
- Though TOSHIBA works continually to improve Product's quality and reliability, Product can malfunction or fail. Customers are responsible for complying with safety standards and for providing adequate designs and safeguards for their hardware, software and systems which minimize risk and avoid situations in which a malfunction or failure of Product could cause loss of human life, bodily injury or damage to property, including data loss or corruption. Before customers use the Product, create designs including the Product, or incorporate the Product into their own applications, customers must also refer to and comply with (a) the latest versions of all relevant TOSHIBA information, including without limitation, this document, the specifications, the data sheets and application notes for Product and the precautions and conditions set forth in the "TOSHIBA Semiconductor Reliability Handbook" and (b) the instructions for the application with which the Product will be used with or for. Customers are solely responsible for all aspects of their own product design or applications, including but not limited to (a) determining the appropriateness of the use of this Product in such design or applications; (b) evaluating and determining the applicability of any information contained in this document, or in charts, diagrams, programs, algorithms, sample application circuits, or any other referenced documents; and (c) validating all operating parameters for such designs and applications. **TOSHIBA ASSUMES NO LIABILITY FOR CUSTOMERS' PRODUCT DESIGN OR APPLICATIONS.**
- **PRODUCT IS NEITHER INTENDED NOR WARRANTED FOR USE IN EQUIPMENTS OR SYSTEMS THAT REQUIRE EXTRAORDINARILY HIGH LEVELS OF QUALITY AND/OR RELIABILITY, AND/OR A MALFUNCTION OR FAILURE OF WHICH MAY CAUSE LOSS OF HUMAN LIFE, BODILY INJURY, SERIOUS PROPERTY DAMAGE AND/OR SERIOUS PUBLIC IMPACT ("UNINTENDED USE").** Except for specific applications as expressly stated in this document, Unintended Use includes, without limitation, equipment used in nuclear facilities, equipment used in the aerospace industry, lifesaving and/or life supporting medical equipment, equipment used for automobiles, trains, ships and other transportation, traffic signaling equipment, equipment used to control combustions or explosions, safety devices, elevators and escalators, and devices related to power plant. **IF YOU USE PRODUCT FOR UNINTENDED USE, TOSHIBA ASSUMES NO LIABILITY FOR PRODUCT.** For details, please contact your TOSHIBA sales representative or contact us via our website.
- Do not disassemble, analyze, reverse-engineer, alter, modify, translate or copy Product, whether in whole or in part.
- Product shall not be used for or incorporated into any products or systems whose manufacture, use, or sale is prohibited under any applicable laws or regulations.
- The information contained herein is presented only as guidance for Product use. No responsibility is assumed by TOSHIBA for any infringement of patents or any other intellectual property rights of third parties that may result from the use of Product. No license to any intellectual property right is granted by this document, whether express or implied, by estoppel or otherwise.
- **ABSENT A WRITTEN SIGNED AGREEMENT, EXCEPT AS PROVIDED IN THE RELEVANT TERMS AND CONDITIONS OF SALE FOR PRODUCT, AND TO THE MAXIMUM EXTENT ALLOWABLE BY LAW, TOSHIBA (1) ASSUMES NO LIABILITY WHATSOEVER, INCLUDING WITHOUT LIMITATION, INDIRECT, CONSEQUENTIAL, SPECIAL, OR INCIDENTAL DAMAGES OR LOSS, INCLUDING WITHOUT LIMITATION, LOSS OF PROFITS, LOSS OF OPPORTUNITIES, BUSINESS INTERRUPTION AND LOSS OF DATA, AND (2) DISCLAIMS ANY AND ALL EXPRESS OR IMPLIED WARRANTIES AND CONDITIONS RELATED TO SALE, USE OF PRODUCT, OR INFORMATION, INCLUDING WARRANTIES OR CONDITIONS OF MERCHANTABILITY, FITNESS FOR A PARTICULAR PURPOSE, ACCURACY OF INFORMATION, OR NONINFRINGEMENT.**
- Do not use or otherwise make available Product or related software or technology for any military purposes, including without limitation, for the design, development, use, stockpiling or manufacturing of nuclear, chemical, or biological weapons or missile technology products (mass destruction weapons). Product and related software and technology may be controlled under the applicable export laws and regulations including, without limitation, the Japanese Foreign Exchange and Foreign Trade Law and the U.S. Export Administration Regulations. Export and re-export of Product or related software or technology are strictly prohibited except in compliance with all applicable export laws and regulations.
- Please contact your TOSHIBA sales representative for details as to environmental matters such as the RoHS compatibility of Product. Please use Product in compliance with all applicable laws and regulations that regulate the inclusion or use of controlled substances, including without limitation, the EU RoHS Directive. **TOSHIBA ASSUMES NO LIABILITY FOR DAMAGES OR LOSSES OCCURRING AS A RESULT OF NONCOMPLIANCE WITH APPLICABLE LAWS AND REGULATIONS.**