

## eFuse IC for robust power supply protection

Toshiba eFuse IC incorporates high-performance, high-accuracy protective functions in a single package, which contributes to shorter designing times and robust protection of power supply lines.

### Outline of TOSHIBA eFuse IC

An eFuse IC is a semiconductor device with a fuse function designed to protect an electronic circuit from overcurrent conditions. The Toshiba eFuse IC has a lot of built-in protective functions and provide many advantages over physical fuses.

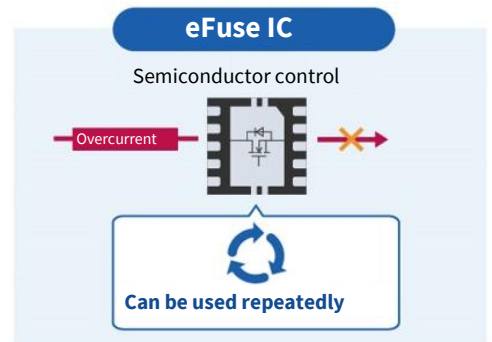
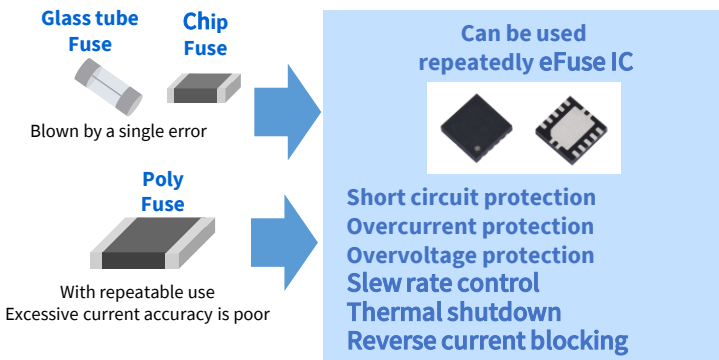

### Main Protective Functions

#### Short circuit protection operation

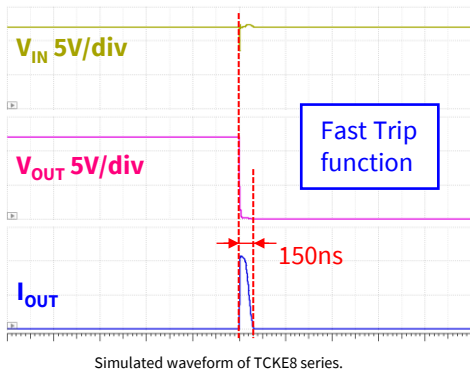

#### Overvoltage protection (OVC, OVP)

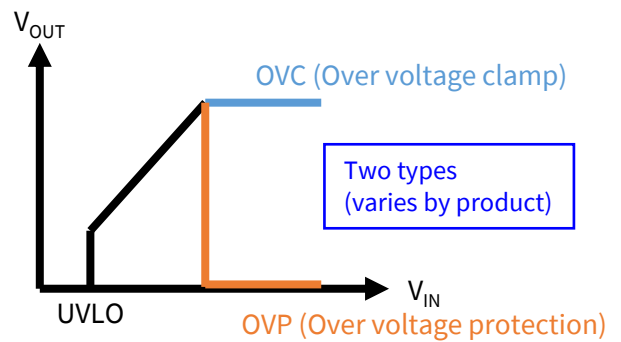

Application note [Click](#)

### eFuse IC Applications diagram

It can be used for all applications requiring functions such as short circuit protection, overcurrent protection, overvoltage protection, slew rate control, reverse current blocking, and thermal shutdown.

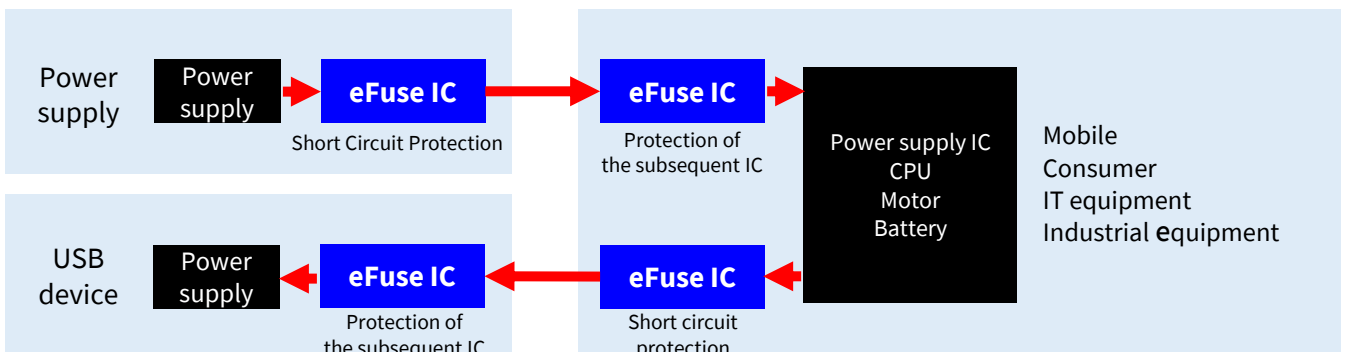

## Example of power supply line combining eFuse IC with Zener diode and Schottky Barrier Diodes(SBD)

The eFuse IC has built-in overvoltage, overcurrent, and short circuit protection functions, but more robust power supply lines can be built by adding external components. If a Zener diode is connected between the input terminal and the GND terminal of eFuse IC, it provides a more robust protection against surges. In addition, the output may become a negative voltage due to the protective operation of eFuse IC, but the negative voltage can be reduced by connecting SBD.

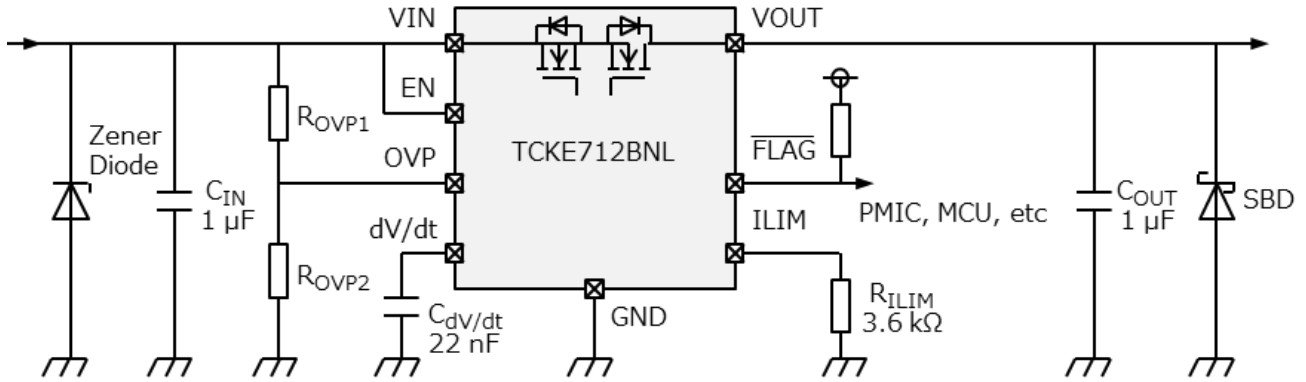

NOTE :Select Zener diodes and SBDs considering the maximum rating of eFuse IC.

### Hot swap protection with Zener diode

Overvoltage occurs when Hot swap. The Zener diodes can easily protect internal circuits.

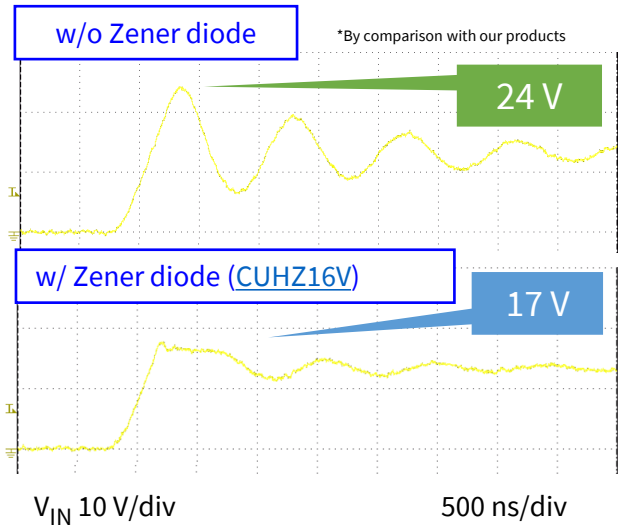
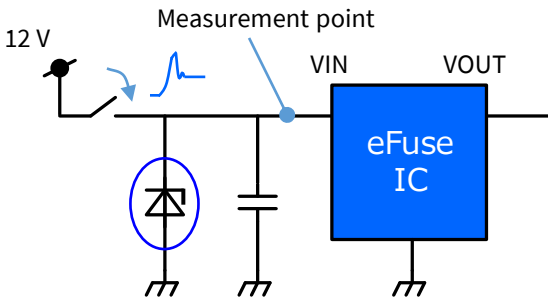

### Negative voltage protection with SBD



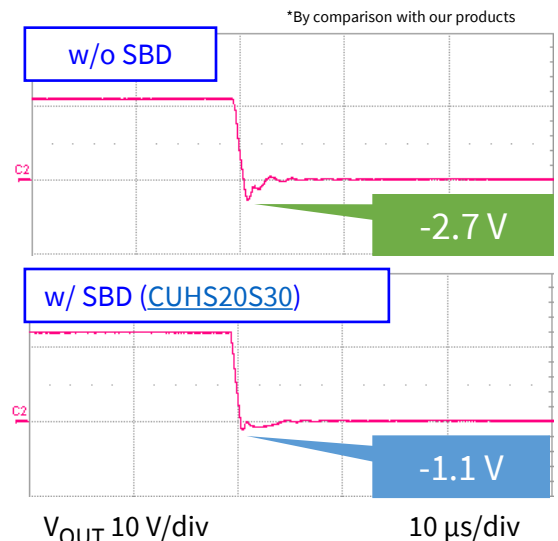
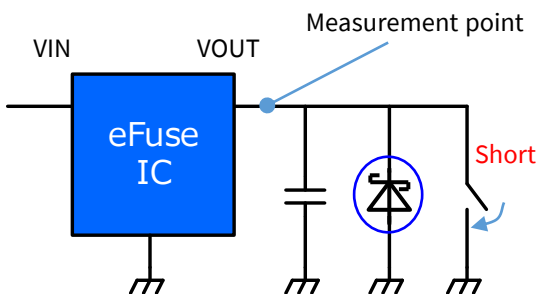

A large negative voltage occurs the output side when the current path is cut off. The SBD can reduce negative voltage.



## •eFuse IC selection table

Product name	Package	Size (mm)	Electrical Characteristics /Switching Characteristics					Additional function										Certification	Purchase
			V <sub>IN</sub> /V (Min)	V <sub>IN</sub> /V (Max)	I <sub>OUT</sub> /A (DC)	R <sub>ON</sub> /mΩ (typ)	I <sub>Q</sub> /mA (typ)	Control Active	SRC	OAD	RCB	OVC/OVP	OCL	TSD	Recovery	Extra			
<a href="#">TCKE800NA</a>	WSON10B	3×3	4.4	18	5	28	0.49	High	Adjustable	Y	Option (OFF)	N	0.5A to 5A Adjustable	Y	Auto-retry	-	Y	<a href="#">Buy Online</a>	
<a href="#">TCKE805NA</a>	WSON10B	3×3	4.4	18	5	28	0.46	High	Adjustable	Y	Option (OFF)	6.04V OVC	0.5A to 5A Adjustable	Y	Auto-retry	-	Y	<a href="#">Buy Online</a>	
<a href="#">TCKE812NA</a>	WSON10B	3×3	4.4	18	5	28	0.49	High	Adjustable	Y	Option (OFF)	15.1V OVC	0.5A to 5A Adjustable	Y	Auto-retry	-	Y	<a href="#">Buy Online</a>	
<a href="#">TCKE800NL</a>	WSON10B	3×3	4.4	18	5	28	0.49	High	Adjustable	Y	Option (OFF)	N	0.5A to 5A Adjustable	Y	Latched	-	Y	<a href="#">Buy Online</a>	
<a href="#">TCKE805NL</a>	WSON10B	3×3	4.4	18	5	28	0.46	High	Adjustable	Y	Option (OFF)	6.04V OVC	0.5A to 5A Adjustable	Y	Latched	-	Y	<a href="#">Buy Online</a>	
<a href="#">TCKE812NL</a>	WSON10B	3×3	4.4	18	5	28	0.49	High	Adjustable	Y	Option (OFF)	15.1V OVC	0.5A to 5A Adjustable	Y	Latched	-	Y	<a href="#">Buy Online</a>	
<a href="#">TCKE712BNL</a>	WSON10	3×3	4.4	13.2	3.65	53	0.69	High	Adjustable	N	Y (OFF)	Adjustable OVP	0.51A to 3.65A Adjustable	Y	Latched	FLAG	Y	<a href="#">Buy Online</a>	
<a href="#">TCKE903NA</a>	WSON8	2×2	2.7	23	4	34	0.18	High	Adjustable	Y	N	3.87V OVC	0.5A to 4A Adjustable	Y	Auto-retry	FLAG	Under planning	<a href="#">Buy Online</a>	
<a href="#">TCKE903NL</a>	WSON8	2×2	2.7	23	4	34	0.18	High	Adjustable	Y	N	3.87V OVC	0.5A to 4A Adjustable	Y	Latched	FLAG	Under planning	<a href="#">Buy Online</a>	
<a href="#">TCKE905ANA</a>	WSON8	2×2	2.7	23	4	34	0.18	High	Adjustable	Y	N	5.7V OVC	0.5A to 4A Adjustable	Y	Auto-retry	FLAG	Under planning	<a href="#">Buy Online</a>	
<a href="#">TCKE905NL</a>	WSON8	2×2	2.7	23	4	34	0.18	High	Adjustable	Y	N	5.7V OVC	0.5A to 4A Adjustable	Y	Latched	FLAG	Under planning	<a href="#">Buy Online</a>	
<a href="#">TCKE912NA</a>	WSON8	2×2	2.7	23	4	34	0.185	High	Adjustable	Y	N	13.7V OVC	0.5A to 4A Adjustable	Y	Auto-retry	FLAG	Under planning	<a href="#">Buy Online</a>	
<a href="#">TCKE912NL</a>	WSON8	2×2	2.7	23	4	34	0.185	High	Adjustable	Y	N	13.7V OVC	0.5A to 4A Adjustable	Y	Latched	FLAG	Under planning	<a href="#">Buy Online</a>	
<a href="#">TCKE920NA</a>	WSON8	2×2	2.7	23	4	34	0.19	High	Adjustable	Y	N	22.2V OVC	0.5A to 4A Adjustable	Y	Auto-retry	FLAG	Under planning	<a href="#">Buy Online</a>	
<a href="#">TCKE920NL</a>	WSON8	2×2	2.7	23	4	34	0.19	High	Adjustable	Y	N	22.2V OVC	0.5A to 4A Adjustable	Y	Latched	FLAG	Under planning	<a href="#">Buy Online</a>	
<a href="#">TCKE903QNA</a>	WSON8	2×2	3.0	23	4	34	0.18	High	Adjustable	Y	N	3.87V OVC	0.5A to 4A Adjustable	Y	Auto-retry	QOD	Under planning	<a href="#">Buy Online</a>	
<a href="#">TCKE905QNA</a>	WSON8	2×2	3.0	23	4	34	0.18	High	Adjustable	Y	N	5.7V OVC	0.5A to 4A Adjustable	Y	Auto-retry	QOD	Under planning	<a href="#">Buy Online</a>	
<a href="#">TCKE601RA</a>	TSOP6F	2.9×2.8	4.4	30	2.5	52	1	-	Fixed	Y	N	32V OVP	0.5A to 2.5A Adjustable	Y	Auto-retry	FLAG, Normally on	-	<a href="#">Buy Online</a>	
<a href="#">TCKE601RL</a>	TSOP6F	2.9×2.8	4.4	30	2.5	52	1	-	Fixed	Y	N	32V OVP	0.5A to 2.5A Adjustable	Y	Latched	FLAG, Normally on	-	<a href="#">Buy Online</a>	
<a href="#">TCKE602RM</a>	TSOP6F	2.9×2.8	4.4	30	2.5	52	1	-	Fixed	Y	N	32V OVP	0.5A to 2.5A Adjustable	Y	Selection type	MODE, Normally on	-	<a href="#">Buy Online</a>	
<a href="#">TCKE603RA</a>	TSOP6F	2.9×2.8	4.4	30	2.5	52	1	High	Fixed	Y	N	32V OVP	0.5A to 2.5A Adjustable	Y	Auto-retry	-	-	<a href="#">Buy Online</a>	
<a href="#">TCKE603RL</a>	TSOP6F	2.9×2.8	4.4	30	2.5	52	1	High	Fixed	Y	N	32V OVP	0.5A to 2.5A Adjustable	Y	Latched	-	-	<a href="#">Buy Online</a>	

SRC: Slew rate control, OAD: Output auto-discharge, RCB: Reverse current blocking, OVC: Overvoltage clamp, OVP: Overvoltage protection (shutdown), OCL: Overcurrent limit, TSD: Thermal shutdown, QOD: Quick output discharge

WSON10B	WSON10	WSON8	TSOP6F
Bottom View	Bottom View	Bottom View	Bottom View
			
3.0 x 3.0	3.0 x 3.0	2.0 x 2.0	2.9 x 2.8

## Related LINK

- [Introduction to eFuse IC Products](#) [Click](#)
- [Application note](#) [Click](#)
- [Frequently Asked Questions for eFuse IC \(FAQ\)](#) [Click](#)
- [Online distributor purchase, inventory search page](#) [Click](#)
- [Cross-reference search](#) [Click](#)
- [eFuse IC feature articles](#) [Click](#)
- [Introduction to Zener diode products](#) [Click](#)
- [Introduction to Schottky Barrier Diodes\(SBD\) products](#) [Click](#)

Company names, product names, and service names may be trademarks of their respective companies.

## RESTRICTIONS ON PRODUCT USE

Toshiba Corporation and its subsidiaries and affiliates are collectively referred to as "TOSHIBA". Hardware, software and systems described in this document are collectively referred to as "Product".

- TOSHIBA reserves the right to make changes to the information in this document and related Product without notice.
- This document and any information herein may not be reproduced without prior written permission from TOSHIBA. Even with TOSHIBA's written permission, reproduction is permissible only if reproduction is without alteration/omission.
- Though TOSHIBA works continually to improve Product's quality and reliability, Product can malfunction or fail. Customers are responsible for complying with safety standards and for providing adequate designs and safeguards for their hardware, software and systems which minimize risk and avoid situations in which a malfunction or failure of Product could cause loss of human life, bodily injury or damage to property, including data loss or corruption. Before customers use the Product, create designs including the Product, or incorporate the Product into their own applications, customers must also refer to and comply with (a) the latest versions of all relevant TOSHIBA information, including without limitation, this document, the specifications, the data sheets and application notes for Product and the precautions and conditions set forth in the "TOSHIBA Semiconductor Reliability Handbook" and (b) the instructions for the application with which the Product will be used with or for. Customers are solely responsible for all aspects of their own product design or applications, including but not limited to (a) determining the appropriateness of the use of this Product in such design or applications; (b) evaluating and determining the applicability of any information contained in this document, or in charts, diagrams, programs, algorithms, sample application circuits, or any other referenced documents; and (c) validating all operating parameters for such designs and applications. **TOSHIBA ASSUMES NO LIABILITY FOR CUSTOMERS' PRODUCT DESIGN OR APPLICATIONS.**
- PRODUCT IS NEITHER INTENDED NOR WARRANTED FOR USE IN EQUIPMENTS OR SYSTEMS THAT REQUIRE EXTRAORDINARILY HIGH LEVELS OF QUALITY AND/OR RELIABILITY, AND/OR A MALFUNCTION OR FAILURE OF WHICH MAY CAUSE LOSS OF HUMAN LIFE, BODILY INJURY, SERIOUS PROPERTY DAMAGE AND/OR SERIOUS PUBLIC IMPACT ("UNINTENDED USE").** Except for specific applications as expressly stated in this document, Unintended Use includes, without limitation, equipment used in nuclear facilities, equipment used in the aerospace industry, lifesaving and/or life supporting medical equipment, equipment used for automobiles, trains, ships and other transportation, traffic signaling equipment, equipment used to control combustions or explosions, safety devices, elevators and escalators, and devices related to power plant. **IF YOU USE PRODUCT FOR UNINTENDED USE, TOSHIBA ASSUMES NO LIABILITY FOR PRODUCT.** For details, please contact your TOSHIBA sales representative or contact us via our website.
- Do not disassemble, analyze, reverse-engineer, alter, modify, translate or copy Product, whether in whole or in part.
- Product shall not be used for or incorporated into any products or systems whose manufacture, use, or sale is prohibited under any applicable laws or regulations.
- The information contained herein is presented only as guidance for Product use. No responsibility is assumed by TOSHIBA for any infringement of patents or any other intellectual property rights of third parties that may result from the use of Product. No license to any intellectual property right is granted by this document, whether express or implied, by estoppel or otherwise.
- ABSENT A WRITTEN SIGNED AGREEMENT, EXCEPT AS PROVIDED IN THE RELEVANT TERMS AND CONDITIONS OF SALE FOR PRODUCT, AND TO THE MAXIMUM EXTENT ALLOWABLE BY LAW, TOSHIBA (1) ASSUMES NO LIABILITY WHATSOEVER, INCLUDING WITHOUT LIMITATION, INDIRECT, CONSEQUENTIAL, SPECIAL, OR INCIDENTAL DAMAGES OR LOSS, INCLUDING WITHOUT LIMITATION, LOSS OF PROFITS, LOSS OF OPPORTUNITIES, BUSINESS INTERRUPTION AND LOSS OF DATA, AND (2) DISCLAIMS ANY AND ALL EXPRESS OR IMPLIED WARRANTIES AND CONDITIONS RELATED TO SALE, USE OF PRODUCT, OR INFORMATION, INCLUDING WARRANTIES OR CONDITIONS OF MERCHANTABILITY, FITNESS FOR A PARTICULAR PURPOSE, ACCURACY OF INFORMATION, OR NONINFRINGEMENT.**
- Do not use or otherwise make available Product or related software or technology for any military purposes, including without limitation, for the design, development, use, stockpiling or manufacturing of nuclear, chemical, or biological weapons or missile technology products (mass destruction weapons). Product and related software and technology may be controlled under the applicable export laws and regulations including, without limitation, the Japanese Foreign Exchange and Foreign Trade Law and the U.S. Export Administration Regulations. Export and re-export of Product or related software or technology are strictly prohibited except in compliance with all applicable export laws and regulations.
- Please contact your TOSHIBA sales representative for details as to environmental matters such as the RoHS compatibility of Product. Please use Product in compliance with all applicable laws and regulations that regulate the inclusion or use of controlled substances, including without limitation, the EU RoHS Directive. **TOSHIBA ASSUMES NO LIABILITY FOR DAMAGES OR LOSSES OCCURRING AS A RESULT OF NONCOMPLIANCE WITH APPLICABLE LAWS AND REGULATIONS.**

Toshiba Electronic Devices & Storage Corporation

<https://toshiba.semicon-storage.com/>