SEMICONDUCTOR GENERAL CATALOG

半導体製品総覧表2019年1月版

Bipolar Transistors

バイポーラトランジスタ

Bipolar Small-Signal Transistors / バイポーラ小信号トランジスタ

Bipolar Power Transistors / バイポーラパワートランジスタ

IGBTs/ IEGTs / IGBT / IEGT

Multi-Chip Discrete Devices / 異品種混載複合デバイス

Radio-Frequency Bipolar Small-Signal Transistors / 高周波バイポーラ小信号トランジスタ

Bipolar Small-Signal Transistors / バイポーラ小信号トランジスタ

General-Purpose Transistor / 汎用トランジスタ

(Single) / (シングル品)

Classification	V _{CE0} (V) Max	I _C (mA) Max	(Surface-Mount Type)									
			CST3		VESM		SSM		USM		UFM	
			(mm)		(mm)		(mm)		(mm)		(mm)	
			NPN	PNP	NPN	PNP	NPN	PNP	NPN	PNP	NPN	PNP
General-purpose	50	100	2SC6026CT	2SA2154CT								
		150			2SC6026MFV	2SA2154MFV	2SC4738	2SA1832	2SC4116	2SA1586		
		200										
	30	500								2SA1588		
	45											
	50											
Low noise	120	100							2SC4117	2SA1587		
Low saturation voltage	15	800										
High current	20	2500										2SA2215
	25	800										
	50	1000									2SC6135	
		1700										2SA2195
	2500									2SC6100		
Muting	20	300							2SC4213			
High breakdown voltage	300	100										
	600	50										

・ For the PNP transistors, the minus sign (-) indicating a negative voltage is omitted.

・ PNPタイプの-符号は省略しています。

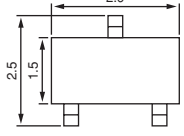
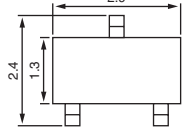
S-MINI		SOT23	
			
(mm)		(mm)	
NPN	PNP	NPN	PNP
2SC2712	2SA1162		
		TBC847 *	TBC857 *
		TMBT3904 *	TMBT3906 *
	2SA1182		
	TTA1713 *		
TTC1949 *			
2SC3325	2SA1313		
2SC2713	2SA1163		
2SC3324	2SA1312		
	2SA1362		
2SC3265	2SA1298		
2SC3326			
	2SA1721		
2SC6105			

*: New product / 新製品

General-Purpose Transistor / 汎用トランジスタ
(Dual) / (デュアル品)

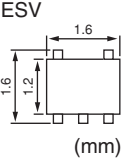
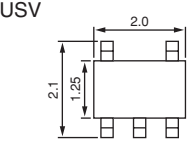
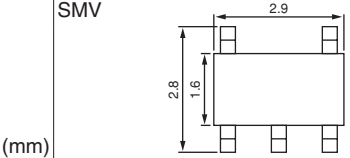
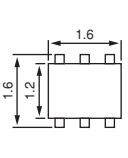
Classification	V _{CEO} (V) Max	I _C (mA) Max	Dual Type											
			ESV			USV			SMV			ES6		
														
PNP + NPN	NPN	PNP	NPN	PNP	PNP + NPN	NPN	PNP	PNP + NPN						
General-purpose	50	150	HN4B01JE (▲6)	2SC4944 (▲2)	2SA1873 (▲1) HN4A56JU (▲4)	2SC4207 (▲2)	2SA1618 (▲1)		HN1C01FE (▲10)	HN1A01FE (▲7)	HN1B04FE (▲9)			
	50	500												
Low noise	120	100				HN4C06J (▲2) HN4C51J (▲5)	HN4A06J (▲1) HN4A51J (▲4)	HN4B06J (▲3)						
High current	15	800												
	25						HN4A08J (▲1)							
Muting	20	300												

- ・ For the PNP transistors, the minus sign (-) indicating a negative voltage is omitted.
- ・ The ratings enclosed in parentheses are for those devices whose part numbers are enclosed in parentheses.
- ・ PNPタイプの-符号は省略しています。
- ・ () 内品種は特性が若干異なります。

US6			SM6		
(mm)			(mm)		
NPN	PNP	PNP + NPN	NPN	PNP	PNP + NPN
HN1C01FU (▲10)	HN1A01FU (▲7)	HN1B01FU (▲8)	HN1C01F (▲10)	HN1A01F (▲7)	HN1B01F (▲8)
HN2C01FU (▲12)	HN2A01FU (▲11)	HN1B04FU (▲9)			
HN3C56FU (▲14)		HN3B02FU (▲13)			
			HN1C07F (▲10)	HN1A07F (▲7)	
				HN1A02F (▲7)	
HN1C03FU (▲10)			HN1C03F (▲10)		

Internal Connections / 内部接続

Number of Pins	▲1	▲2	▲3	▲4	▲5	▲6
5						
6						
6						

・ The internal connection diagrams only show the general configurations of the circuits. / 内部接続図はイメージ図です。

Bias Resistor Built-in Transistors / 抵抗内蔵型トランジスタ (BRT)

(Single, General-Purpose) / (シングル品, 汎用タイプ)

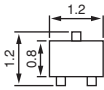
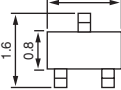
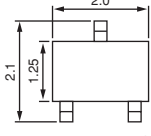
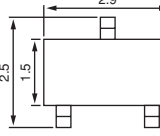
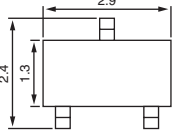
Ratings		50											
		100											
Internal Resistors (kΩ)		VESM		SSM		USM		S-MINI		SOT23			
													
R1	R2	NPN		PNP		NPN		PNP		NPN		PNP	
4.7	4.7	RN1101MFV	RN2101MFV	RN1101	RN2101	RN1301	RN2301	RN1401	RN2401	TDTC143E *	TDTA143E *		
10	10	RN1102MFV	RN2102MFV	RN1102	RN2102	RN1302	RN2302	RN1402	RN2402	TDTC114E *	TDTA114E *		
22	22	RN1103MFV	RN2103MFV	RN1103	RN2103	RN1303	RN2303	RN1403	RN2403	TDTC124E *	TDTA124E *		
47	47	RN1104MFV	RN2104MFV	RN1104	RN2104	RN1304	RN2304	RN1404	RN2404	TDTC144E *	TDTA144E *		
2.2	47	RN1105MFV	RN2105MFV	RN1105	RN2105	RN1305	RN2305	RN1405	RN2405	TDTC123J *	TDTA123J *		
4.7	47	RN1106MFV	RN2106MFV	RN1106	RN2106	RN1306	RN2306	RN1406	RN2406	TDTC143Z *	TDTA143Z *		
10	47	RN1107MFV	RN2107MFV	RN1107	RN2107	RN1307	RN2307	RN1407	RN2407	TDTC114Y *	TDTA114Y *		
22	47	RN1108MFV	RN2108MFV	RN1108	RN2108	RN1308	RN2308	RN1408	RN2408				
47	22	RN1109MFV	RN2109MFV	RN1109	RN2109	RN1309	RN2309	RN1409	RN2409				
4.7	—	RN1110MFV	RN2110MFV	RN1110	RN2110	RN1310	RN2310	RN1410	RN2410				
10	—	RN1111MFV	RN2111MFV	RN1111	RN2111	RN1311	RN2311	RN1411	RN2411				
22	—	RN1112MFV	RN2112MFV	RN1112	RN2112	RN1312	RN2312	RN1412	RN2412				
47	—	RN1113MFV	RN2113MFV	RN1113	RN2113	RN1313	RN2313	RN1413	RN2413				
1	10	RN1114MFV	RN2114MFV	RN1114	RN2114	RN1314	RN2314	RN1414	RN2414				
2.2	10	RN1115MFV	RN2115MFV	RN1115	RN2115	RN1315	RN2315	RN1415	RN2415				
4.7	10	RN1116MFV	RN2116MFV	RN1116	RN2116	RN1316	RN2316	RN1416	RN2416				
10	4.7	RN1117MFV	RN2117MFV	RN1117	RN2117	RN1317	RN2317	RN1417	RN2417				
47	10	RN1118MFV	RN2118MFV	RN1118	RN2118	RN1318	RN2318	RN1418	RN2418				
1	—	RN1119MFV	RN2119MFV										
100	100	RN1130MFV	RN2130MFV										
100	—	RN1131MFV	RN2131MFV										
200	—	RN1132MFV	RN2132MFV										

• For the PNP transistors, the minus sign (-) indicating a negative voltage is omitted.

*: New product / 新製品

• PNPタイプの-符号は省略しています。

(Single, High-Current/Muting Switch) / (シングル品, ハイカレントタイプ/ミュートスイッチタイプ)

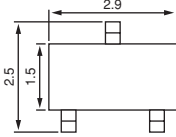
Ratings		High Current			
		800			
Internal Resistors (kΩ)		S-MINI			
					
R1	R2	NPN		PNP	
1	1	RN1421		RN2421	
2.2	2.2	RN1422		RN2422	
4.7	4.7	RN1423		RN2423	
10	10	RN1424		RN2424	
0.47	10	RN1425		RN2425	
1	10	RN1426		RN2426	
2.2	10	RN1427		RN2427	

• For the PNP transistors, the minus sign (-) indicating a negative voltage is omitted.

• PNPタイプの-符号は省略しています。

Bias Resistor Built-in Transistors / 複合抵抗内蔵型トランジスタ (BRT)

(Dual, General-Purpose) / (デュアル品, 汎用タイプ)

Classification	Absolute Maximum Ratings		Internal Resistors				ESV		USV		SMV												
	V _{CEO}	I _C	Q1		Q2																		
	(V)	(mA)	(kΩ)		(kΩ)		NPN x 2	PNP x 2	NPN x 2	PNP x 2	NPN x 2	PNP x 2											
			R1	R2	R1	R2																	
												Common emitter		Common emitter		Common emitter		Common emitter		Common emitter		Common emitter	
General-purpose	50	100	4.7	4.7	4.7	4.7	RN1701JE	RN2701JE	RN1701	RN2701	RN1501	RN2501											
			10	10	10	10	RN1702JE	RN2702JE	RN1702	RN2702	RN1502	RN2502											
			22	22	22	22	RN1703JE	RN2703JE	RN1703	RN2703	RN1503	RN2503											
			47	47	47	47	RN1704JE	RN2704JE	RN1704	RN2704	RN1504	RN2504											
			2.2	47	2.2	47	RN1705JE	RN2705JE	RN1705	RN2705	RN1505	RN2505											
			4.7	47	4.7	47	RN1706JE	RN2706JE	RN1706	RN2706	RN1506	RN2506											
			10	47	10	47	RN1707JE	RN2707JE	RN1707	RN2707	RN1507	RN2507											
			22	47	22	47	RN1708JE	RN2708JE	RN1708	RN2708	RN1508												
			47	22	47	22	RN1709JE	RN2709JE	RN1709	RN2709	RN1509												
			4.7	—	4.7	—	RN1710JE	RN2710JE	RN1710	RN2710	RN1510	RN2510											
			10	—	10	—	RN1711JE	RN2711JE	RN1711	RN2711	RN1511	RN2511											
			22	—	22	—		RN2712JE															
			47	—	47	—		RN2713JE															
									RN2714														

- ・ For the PNP transistors, the minus sign (-) indicating a negative voltage is omitted.
- ・ The internal connection diagrams only show the general configurations of the circuits.
- ・ PNPタイプの-符号は省略しています。
- ・ 内部接続図はイメージ図です。

Bias Resistor Built-in Transistors / 複合抵抗内蔵型トランジスタ (BRT)

(Dual, General-Purpose) / (デュアル品, 汎用タイプ)

Classification	Absolute Maximum Ratings		Internal Resistors				ES6			
	V _{CEO} (V)	I _c (mA)	Q1		Q2					
			(kΩ)	(kΩ)	(kΩ)	(kΩ)				
			R1	R2	R1	R2	NPN x 2	PNP x 2	PNP + NPN	NPN + PNP
General-purpose	50	100	4.7	4.7	4.7	4.7	RN1901FE	RN2901FE	RN4901FE	RN4981FE
			10	10	10	10	RN1902FE	RN2902FE	RN4902FE	RN4982FE
			22	22	22	22	RN1903FE	RN2903FE	RN4903FE	RN4983FE
			47	47	47	47	RN1904FE	RN2904FE	RN4904FE	RN4984FE
			2.2	47	2.2	47	RN1905FE	RN2905FE	RN4905FE	RN4985FE
			4.7	47	4.7	47	RN1906FE	RN2906FE	RN4906FE	RN4986FE
			10	47	10	47	RN1907FE	RN2907FE	RN4907FE	RN4987FE
			22	47	22	47	RN1908FE	RN2908FE	RN4908FE	RN4988FE
			47	22	47	22	RN1909FE	RN2909FE	RN4909FE	RN4989FE
			4.7	—	4.7	—	RN1910FE	RN2910FE	RN4910FE	RN4990FE
			10	—	10	—	RN1911FE	RN2911FE	RN4911FE	RN4991FE
			2.2	47	2.2	47			RN49A1FE	

- For the PNP transistors, the minus sign (-) indicating a negative voltage is omitted.
- The internal connection diagrams only show the general configurations of the circuits.
- PNPタイプの-符号は省略しています。
- 内部接続図はイメージ図です。

Classification	Absolute Maximum Ratings		Internal Resistors				US6					
	V _{CEO} (V)	I _c (mA)	Q1		Q2							
			(kΩ)	(kΩ)	(kΩ)	(kΩ)						
			R1	R2	R1	R2	NPN x 2	PNP x 2	NPN x 2	PNP x 2	PNP + NPN	NPN + PNP
General-purpose	50	100	4.7	4.7	4.7	4.7	RN1901	RN2901	RN1961	RN2961	RN4901	RN4981
			10	10	10	10	RN1902	RN2902	RN1962	RN2962	RN4902	RN4982
			22	22	22	22	RN1903	RN2903	RN1963	RN2963	RN4903	RN4983
			47	47	47	47	RN1904	RN2904	RN1964	RN2964	RN4904	RN4984
			2.2	47	2.2	47	RN1905	RN2905	RN1965	RN2965	RN4905	RN4985
			4.7	47	4.7	47	RN1906	RN2906		RN2966	RN4906	RN4986
			10	47	10	47	RN1907	RN2907		RN2967	RN4907	RN4987
			22	47	22	47	RN1908	RN2908	RN1968	RN2968	RN4908	RN4988
			47	22	47	22	RN1909	RN2909		RN2969	RN4909	
			4.7	—	4.7	—	RN1910	RN2910	RN1970	RN2970	RN4910	RN4990
			10	—	10	—	RN1911	RN2911	RN1971	RN2971	RN4911	
			47	—	47	—			RN1973			
			2.2	47	2.2	47					RN49A1	
			47	47	2.2	47						RN49A2

- For the PNP transistors, the minus sign (-) indicating a negative voltage is omitted.
- The internal connection diagrams only show the general configurations of the circuits.
- PNPタイプの-符号は省略しています。
- 内部接続図はイメージ図です。

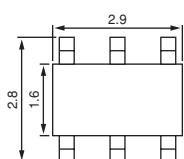
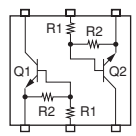
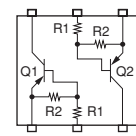
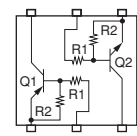
Classification	Absolute Maximum Ratings		Internal Resistors				SM6			
	V _{CEO} (V)	I _c (mA)	Q1		Q2		 (mm)	NPN x 2	PNP x 2	PNP + NPN
			R1 (kΩ)	R2 (kΩ)	R1 (kΩ)	R2 (kΩ)				
			R1	R2	R1	R2				
General-purpose	50	100	4.7	4.7	4.7	4.7	RN1601	RN2601	RN4601	
			10	10	10	10	RN1602	RN2602	RN4602	
			22	22	22	22	RN1603	RN2603	RN4603	
			47	47	47	47	RN1604	RN2604	RN4604	
			2.2	47	2.2	47	RN1605	RN2605	RN4605	
			4.7	47	4.7	47	RN1606	RN2606	RN4606	
			10	47	10	47	RN1607	RN2607	RN4607	
			22	47	22	47	RN1608	RN2608	RN4608	
			47	22	47	22	RN1609		RN4609	
			4.7	—	4.7	—	RN1610	RN2610	RN4610	
			10	—	10	—	RN1611	RN2611	RN4611	
			22	22	10	10			RN46A1	

- ・ For the PNP transistors, the minus sign (-) indicating a negative voltage is omitted.
- ・ The internal connection diagrams only show the general configurations of the circuits.
- ・ PNPタイプの-符号は省略しています。
- ・ 内部接続図はイメージ図です。

Bipolar Power Transistors / バイポーラパワートランジスタ

Radio-Frequency Switching Power Transistors / 高速スイッチング用パワートランジスタ (2SA/2SC/TTA/TTC Series) / (2SA, 2SC, TTA, TTC シリーズ)

V _{CEO} (V) I _c (A)	10	20	30	50
1			HN4B101J (M)(V) (NPN: 1.2 A)	2SA2070 (◎) 2SC5810 (◎) TPCP8901 (M)(P) (PNP: 0.8 A) TTA007 (♣) TTC007 (♣)
1.5	2SA2058 (♣)	2SA2065 (♣) 2SC5784 (♣) 2SA2069 (◎) 2SC5819 (◎)		
2	2SA2066 (◎) 2SC5755 (♣) 2SC5785 (◎) TPCP8504 (P)		TPCP8902 (M)(P) HN4B102J (M)(V) (PNP: -1.8A)	2SA1241 2SC3076 (◇) 2SA2056 (♣) TPCP8701 (W)(P) 2SA2060 (◎)
2.5		2SA2061 (♣)		2SC5692 (♣) 2SC6033 (♣) TPCP8602 (P)
3		2SA2059 (◎)	2SC5976 (♣) TPCP8H02 (\$)(P)	2SC5712 (◎) TPCP8505 (P) 2SC6126 (◎) TPCP8511 (P)
3.5		2SC5738 (♣)		
4	2SC5713 (◎)	2SC5714 (◎) 2SC6125 (◎) TPCP8601 (P)	2SC5906 (♣)	2SC5703 (♣)
5				2SA1244 (◇) 2SA2097 (◇) TTA005 (◇) 2SC5886A (◇) TTC016 (◇)
7				2SC6000 (◇)

Legend / 凡例

Package		Other Remarks
Through-Hole Package	Surface-Mount Package	
(◇) PW-Mold (▽) TO-3P(N) (※) TO-3P(L) (♣) TO-220SIS (◎) TO-126N	(♣) TSM (◎) PW-Mini (◇) PW-Mold (P) PS-8 (V) SMV	(%) Darlington (#) Built-in Zener diode Part number in italic signifies built in freewheel diode. 2SA****/2SC****: Complementary (&) 2-in-1 (transistor + diode) (\$) 2-in-1 (transistor + S-MOS) (W) 2-in-1 (NPN (or PNP) × 2) (M) 2-in-1 (NPN + PNP)

V _{CEO} I _c (A)	80	120	140	160	200
0.8		2SA1201 2SC2881 (◎)			
1		TPCP8507 (P) TPCP8510 (P) 2SC6061 (♣)			
1.5				2SA1225 (◇) TTA004B TTC004B (@)	
2	2SA2206 2SC6124 (◎) TTA008B TTC015B (@)				
3	TTA003 (◇) TTA009 (◇) 2SC6076 (◇) TTC017 (◇)				
5	2SC3303 (◇)				
10			2SA1941 2SC5198 (▽)		
12	TTA1452B TTC3710B (▲)			2SA1942 2SC5199 (※)	
15					2SA2120 2SC5948 (▽) 2SA2121 2SC5949 (※)
18				TTA0001 TTC0001 (▽) TTA0002 TTC0002 (※)	

V _{CEO} I _c (A)	230	300	350/375/400	(550)/600	800
0.05					2SC6127 (◇) TTC5460B (@)
0.3			TPCP8604 (P)		
0.5			TTC013 (350 V) (◎) 2SA1971 (◎)	2SA2142 (◇)	
1	TTA006B TTC011B (@)	TTC005 (285 V) (◎)		2SA2184 (550 V) (◇)	TTC014 (◇)
1.5		TTC008 (285 V) (◇)	2SC6142 (375 V) (◇)		
2			2SA2034 2SC5548A (◇) TTC012 (375 V) (◇)		
5					2SC5354 (▽)
15	2SA1943 2SC5200 (※) 2SA1943N 2SC5200N (▽) 2SA1987 2SC5359 (※) TTA1943 TTC5200 (※) 2SA1962 2SC5242 (▽) 2SA1986 2SC5358 (▽)				

Legend / 凡例

Package		Other Remarks
Through-Hole Package	Surface-Mount Package	
(◇) PW-Mold	(♣) TSM	(%) Darlington
(▽) TO-3P(N)	(◎) PW-Mini	(#) Built-in Zener diode
(※) TO-3P(L)	(◇) PW-Mold	Part number in italic signifies built in freewheel diode.
(▲) TO-220SIS	(P) PS-8	2SA****/2SC****: Complementary
(@) TO-126N	(V) SMV	(&) 2-in-1 (transistor + diode)
		(\$) 2-in-1 (transistor + S-MOS)
		(W) 2-in-1 (NPN (or PNP) × 2)
		(M) 2-in-1 (NPN + PNP)

Low-Frequency Power Transistors / 低周波用パワートランジスタ
(2SB/2SD/TTB/TTD Series) / (2SB, 2SD, TTB, TTD シリーズ)

V _{CEO} I _c (A)	60/(65)	80	100	120	250	400
0.8	2SD2719 (#)(%)(♠)					
0.9				TPCP8L01 ⁽¹⁾ (&)(P)		
1	2SD2686 (#)(%)(◎)					
2		TTB1067B TTD1509B (@)				
3	2SB906 (◇) TTB002 (◇)					
4		2SD1223 (%)(◇)				
6					TTD1410B (▲)(%)	TTD1409B (▲)(%)
7				TTB1020B TTD1415B (▲)(%)		

Note (1): NPN + HED (200 V/1 A)

Legend / 凡例

Package		Other Remarks
Through-Hole Package	Surface-Mount Package	
(◇) PW-Mold (▽) TO-3P(N) (※) TO-3P(L) (▲) TO-220SIS (@) TO-126N	(♠) TSM (◎) PW-Mini (◇) PW-Mold (P) PS-8 (V) SMV	(%) Darlington (#) Built-in Zener diode Part number in italic signifies built in freewheel diode. 2SA****/2SC****: Complementary (&) 2-in-1 (transistor + diode) (\$) 2-in-1 (transistor + S-MOS) (W) 2-in-1 (NPN (or PNP) × 2) (M) 2-in-1 (NPN + PNP)

Transistors for Power Amps / パワーアンプ用トランジスタ
(Output Stage) / (出力段)

Part Number		I _c (A)	V _{CEO} (V)	P _c (W) T _c = 25°C	f _r (MHz) Typ. (NPN/PNP)	V _{CE} (V)	I _c (A)	Package
NPN	PNP							
2SC5198	2SA1941	10	140	100	30	5	1	TO-3P(N)
TTC0001	TTA0001	18	160	150	30	5	1	
2SC5200N	2SA1943N	15	230	150	30	5	1	
2SC5948	2SA2120	12	200	200	30/25	5	1	
2SC5199	2SA1942	12	160	120	30	5	1	
TTC0002	TTA0002	18	160	180	30	5	1	TO-3P(L)
TTC5200	TTA1943	15	230	150	30	5	1	
2SC5359	2SA1987	15	230	180	30	5	1	
2SC5949	2SA2121	15	200	220	30/25	5	1	

(Driver Stage) / (ドライバ段)

Part Number		I _c (A)	V _{CEO} (V)	P _c (W) T _c = 25°C	f _r (MHz) Typ. (NPN/PNP)	V _{CE} (V)	I _c (A)	Package
NPN	PNP							
2SC2881	2SA1201	0.8	120	1 ⁽¹⁾	120	5	0.1	PW-Mini
TTC004B	TTA004B	1.5	160	10	100	10	0.1	TO-126N
TTC011B	TTA006B	1	230	10	100/70	10	0.1	

Note (1): The rating applies when the transistor is mounted on an FR-4 board (Cu area = 645 mm², glass-epoxy, t = 1.6 mm), Ta = 25°C /

FR-4 基板 (Cu面積645 mm²、ガラスエポキシ、t = 1.6 mm) 実装時、Ta = 25°C

Transistors for MOS Gate Drivers / MOSゲートドライバ用トランジスタ

(1-in-1 Transistors for Small-Motor Driver Applications) / (小型モータドライバ用, 1-in-1 トランジスタ)

Part Number	Polarity	Absolute Maximum Ratings				h _{FE}		V _{CE(sat)}			Complementary	Package	Remarks			
		V _{CEO} (V)	I _C (A)	P _C ⁽¹⁾ (mW)	Min	Max	V _{CE} (V)	I _C (A)	V _{CE(sat)} (V)	I _C (A)				I _B (mA)		
															Max	Max
2SA2058	PNP	-10	-1.5	500	200	500	-2	-0.2	-0.19	-0.6	-20	2SC5755	<p>TSM (mm)</p>			
2SA2065		-20	-1.5	500	200	500	-2	-0.15	-0.14	-0.5	-17	2SC5784				
2SA2061		-20	-2.5	625	200	500	-2	-0.5	-0.19	-1.6	-53	2SC5738				
TTA007		-50	-1	700	200	500	-2	-0.1	-0.2	-0.3	-10	TTA007				
2SA2056		-50	-2	625	200	500	-2	-0.3	-0.20	-1.0	-33	2SC5692				
2SC5755	NPN	10	2	500	400	1000	2	0.2	0.12	0.6	12	2SA2058			<p>PW-Mini (mm)</p>	
2SC5784		20	1.5	500	400	1000	2	0.15	0.12	0.5	10	2SA2065				
2SC5738		20	3.5	625	400	1000	2	0.5	0.15	1.6	32	2SA2061				
TTA007		50	1	700	400	1000	2	0.1	0.12	0.3	6	TTA007				
2SC5692		50	2.5	625	400	1000	2	0.3	0.14	1.0	20	2SA2056				
2SA2066	PNP	-10	-2	1000	200	500	-2	-0.2	-0.19	-0.6	-20	2SC5785	<p>PW-Mini (mm)</p>			
2SA2069		-20	-1.5	1000	200	500	-2	-0.15	-0.14	-0.5	-17	2SC5819				
2SA2059		-20	-3	1000	200	500	-2	-0.5	-0.19	-1.6	-53	2SC5714				
2SA2070		-50	-1	1000	200	500	-2	-0.1	-0.20	-0.3	-10	2SC5810				
2SA2060		-50	-2	1000	200	500	-2	-0.3	-0.20	-1.0	-33	2SC5712				
2SC5785	NPN	10	2	1000	400	1000	2	0.2	0.12	0.6	12	2SA2066			<p>PW-Mini (mm)</p>	
2SC5819		20	1.5	1000	400	1000	2	0.15	0.12	0.5	10	2SC2069				
2SC5714		20	4	1000	400	1000	2	0.5	0.15	1.6	32	2SA2059				
2SC5810		50	1	1000	400	1000	2	0.1	0.17	0.3	6	2SA2070				
2SC5712		50	3	1000	400	1000	2	0.3	0.14	1	20	2SA2060				
2SC6126	50	3	1000	250	400	2	0.3	0.18	1	33	—	(2)				

Note (1): The rating applies when the transistor is mounted on an FR-4 board (Cu area = 645 mm², glass-epoxy, t = 1.6 mm) . /

FR-4基板 (Cu面積645 mm²、ガラスエポキシ、t = 1.6 mm) 実装時

(2): Ultra-high-speed using the Super Hi-Met process and Low V_{CE(sat)} products. /

超高速品 (プロセス: Super Hi-Met) および低V_{CE(sat)}品

(2-in-1 Transistors for Small-Motor Driver Applications) / (小型モータドライバ用, 2-in-1 トランジスタ)

Part Number	Polarity	Absolute Maximum Ratings				h _{FE}		V _{CE(sat)}			Package	Circuit Configuration (Top View)		
		V _{CEO} (V)	I _C (A)	I _{CP} (A)	P _C ⁽¹⁾ (mW)	Min	Max	V _{CE} (V)	I _C (A)	V _{CE(sat)} (V)			I _C (A)	I _B (mA)
HN4B101J	PNP	-30	-1.0	-5	550	200	500	-2	-0.12	-0.2	-0.4	-13	SMV	
	NPN	30	1.2	5	550	200	500	2	0.12	0.17	0.4	13		
HN4B102J	PNP	-30	-1.8	-8	750	200	500	-2	-0.2	-0.2	-0.6	-20		
	NPN	30	2	8	750	200	500	2	0.2	0.14	0.6	20		
TPCP8901	PNP	-50	-0.8	-5	830	200	500	-2	-0.1	-0.2	-0.3	-10	PS-8	
	NPN	50	1	5	830	400	1000	2	0.1	0.17	0.3	6		
TPCP8902	PNP	-30	-2	-8	890	200	500	-2	-0.2	-0.2	-0.6	-20		
	NPN	30	2	8	890	200	500	2	0.2	0.14	0.6	20		

Note (1): The rating applies when the transistor is mounted on an FR-4 board (Cu area = 645 mm², glass-epoxy, t = 1.6 mm) and is in single-device operation.

Copper thickness: 70 μm

FR-4基板 (Cu面積645 mm²、ガラスエポキシ、t = 1.6 mm) 実装時, 1素子通電時

Cu 70 μm厚

Transistors for Switching Power Supplies / スイッチング電源用トランジスタ
(For AC/DC Converters) / (AC-DCコンバータ用)

Part Number	Applications	Absolute Maximum Ratings (Ta = 25°C)				Package	
		V _{CB0} (V)	V _{CEO} (V)	I _c (A)	P _c (W) T _c = 25°C (♣ Ta = 25°C)		
TTC005	Switching regulator	600	285	1	1.1♣ ⁽¹⁾	PW-Mini	
TTC008				1.5	1.1♣	PW-Mold	
TTC013			350	0.5	1♣ ⁽¹⁾	PW-Mini	
2SC5548A			400	2	15	PW-Mold	
2SC6142		800	375	1.5	1.1♣	PW-Mold	
TTC012				2	1.1♣	PW-Mold	
TTC014			900	800	1	40	PW-Mold
2SC5354			900	800	5	100	TO-3P(N)

Note (1): The rating applies when the transistor is mounted on an FR-4 board (Cu area = 645 mm², glass-epoxy, t = 1.6 mm). /

FR-4基板 (Cu面積645 mm²、ガラスエポキシ、t = 1.6 mm) 実装時

General-Purpose Transistors / 汎用トランジスタ
(TO-220SIS)

Part Number		Absolute Maximum Ratings (Ta = 25°C)			h _{FE}		V _{CE(sat)}	I _c (A)	I _B (A)	Remarks		
NPN	PNP	V _{CEO} (V)	I _c (A)	P _c (W) T _c = 25°C	Min	Max					V _{CE} (V)	I _c (A)
TTC3710B	TTA1452B	80	12	30	120	240	1	1	0.4	6	0.3	
TTD1415B	TTB1020B	100	7	25/30	2000	15000	3	3	1.5	3	6 m	Darlington
TTD1410B	—	250	6	25	2000	—	2	2	2.0	4	40 m	Darlington
TTD1409B	—	400	6	25	600	—	2	2	2.0	4	40 m	Darlington

(TO-126N)

Part Number		Absolute Maximum Ratings (Ta = 25°C)			h _{FE}		V _{CE(sat)}	I _c (A)	I _B (A)	Remarks		
NPN	PNP	V _{CEO} (V)	I _c (A)	P _c (W) T _c = 25°C	Min	Max					V _{CE} (V)	I _c (A)
TTC015B	TTA008B	80	2	15	100	200	2	0.5	0.5	1	0.1	
TTD1509B	TTB1067B	80	2	15	2000	—	2	1	1.5	1	1 m	Darlington
TTC004B	TTA004B	160	1.5	15	140	280	5	0.1	0.5	0.5	50 m	
TTC011B	TTA006B	230	1	15	100	320	5	0.2	1.0	0.3	30 m	
TTC5460B	—	800	0.05	15	15	—	5	7 m	1.0	20 m	4 m	

Transistors for High-Voltage Power Supplies / 高電圧電源用トランジスタ (For DC/DC Converters) / (DC-DCコンバータ用)

Part Number	Absolute Maximum Ratings				hFE				VCE(sat) (V)			Package
	VCEX (V)	VCEO (V)	Ic (A)	Pc (W)	Min	Max	VCE (V)	Ic (A)	Max	Ic (A)	Ib (mA)	
2SC6061	150	120	1	0.625 ⁽¹⁾	120	300	2	0.1	0.14	0.3	10	TSM
TPCP8510	150	120	1	1.1 ⁽¹⁾	120	300	2	0.1	0.14	0.3	10	PS-8
TPCP8507	150	120	1	1.25 ⁽¹⁾	120	300	2	0.1	0.14	0.3	10	PS-8
2SC6076	160	80	3	10 ⁽²⁾	180	450	2	0.5	0.5	1	100	PW-Mold
2SC6124	160	80	2	1 ⁽¹⁾	100	200	2	0.5	0.5	1	100	PW-Mini
TTC015B	160	80	2	10 ⁽²⁾	100	200	2	0.5	0.5	1	100	TO-126N

Note (1): The rating applies when the transistor is mounted on an FR-4 board (Cu area = 645 mm², glass-epoxy, t = 1.6 mm). /

FR-4基板 (Cu面積645 mm²、ガラスエポキシ、t = 1.6 mm) 実装時

(2): Tc = 25°C

(Transistors for Linear Regulators) / (ドロップ用)

Part Number	Absolute Maximum Ratings			hFE				VCE(sat) (V)			Package
	VCEO (V)	Ic (A)	Pc (W) Tc = 25°C	Min	Max	VCE (V)	Ic (A)	Max	Ic (A)	Ib (mA)	
2SB906	-60	-3	20	60	200	-5	-0.5	-1.7	-3	-300	PW-Mold
TTB002	-60	-3	30	100	250	-5	-0.5	-1.7	-3	-300	PW-Mold
TTA005	-50	-5	24	200	500	-2	-0.5	-0.27	-1.6	-53	PW-Mold

(High-Voltage Transistors) / (高耐圧トランジスタ部)

Part Number	Absolute Maximum Ratings			Package	Circuit Configuration (Top View)	Remarks
	VCEO (V)	Ic (A)	Pc (W)			
2SA1971	-400	-0.5	1 ⁽¹⁾	PW-Mini		
TPCP8604	-400	-0.3	1.1 ⁽¹⁾	PS-8		SMD
2SA2184	-550	-1	20 ⁽²⁾	PW-Mold		SMD only
2SA2142	-600	-0.5	15 ⁽²⁾	PW-Mold		SMD only
2SC6127	800	0.05	10 ⁽²⁾	PW-Mold		SMD only
TTC5460B	800	0.05	10 ⁽²⁾	TO-126N		

Note (1): The rating applies when the transistor is mounted on an FR-4 board (Cu area = 645 mm², glass-epoxy, t = 1.6 mm). /

FR-4基板 (Cu面積645 mm²、ガラスエポキシ、t = 1.6 mm) 実装時

(2): Tc = 25°C

- ・ The circuit configuration diagrams only show the general configurations of the circuits.
- ・ 内部構成はイメージ図です。

Low-Saturation-Voltage Transistors / 低飽和電圧トランジスタ

(Small Surface-Mount Packages for Personal Equipments) / (携帯機器用小型面実装パッケージ)

Part Number	Configuration	Absolute Maximum Ratings					hFE				V _{CE(sat)} (V)			Marking	Package
		V _{CEO} (V)	I _C (A)	I _{CP} (A)	P _C (mW) (1)	P _C (mW) t = 10 s	Min	Max	V _{CE} (V)	I _C (A)	Max	I _C (A)	I _B (mA)		
2SA2058	PNP single	-10	-1.5	-2.5	500	750	200	500	-2	-0.2	-0.19	-0.6	-20	WM	TSM equivalent to SC-59 SOT-23
2SA2065		-20	-1.5	-2.5	500	750	200	500	-2	-0.15	-0.14	-0.5	-17	WK	
2SA2061		-20	-2.5	-4	625	1000	200	500	-2	-0.5	-0.19	-1.6	-53	WE	
TTA007		-50	-1	-2	700	1100	200	500	-2	-0.1	-0.2	-0.3	-10	WH	
2SA2056		-50	-2	-3.5	625	1000	200	500	-2	-0.3	-0.20	-1.0	-33	WF	
2SC5755	NPN single	10	2	3.5	500	750	400	1000	2	0.2	0.12	0.6	12	WL	
2SC5784		20	1.5	2.5	500	750	400	1000	2	0.15	0.12	0.5	10	WJ	
2SC5738		20	3.5	6	625	1000	400	1000	2	0.5	0.15	1.6	32	WD	
2SC5976		30	3	5	625	1000	250	400	2	0.3	0.14	1.0	33	WW	
2SC5906		30	4	7	800	1250	200	500	2	0.5	0.2	1.6	53	WP	
TTC007		50	1	2	700	1100	400	1000	2	0.1	0.12	0.3	6	WG	
2SC5692		50	2.5	4	625	1000	400	1000	2	0.3	0.14	1.0	20	WB	
2SC6033		50	2.5	5	625	1000	250	400	2	0.3	0.18	1.0	33	WX	
2SC5703		50	4	7	800	1250	400	1000	2	0.5	0.12	1.6	32	WA	
2SC6061		120	1	2	625	1000	120	300	2	0.1	0.14	0.3	10	WN	
HN4B101J	PNP + NPN	±30	-1/1.2	±5	550	850	200	500	±2	±0.12	-0.2/0.17	±0.4	±13	5K	SMV
HN4B102J		±30	-1.8/2	±8	750	750	200	500	±2	±0.2	-0.2/0.14	±0.6	±20	5L	
2SA2066	PNP single	-10	-2	-3.5	1000	2000	200	500	-2	-0.2	-0.19	-0.6	-20	4E	PW-Mini equivalent to SC-62 SOP-89
2SA2069		-20	-1.5	-2.5	1000	2000	200	500	-2	-0.15	-0.14	-0.5	-17	4D	
2SA2059		-20	-3	-5	1000	2500	200	500	-2	-0.5	-0.19	-1.6	-53	4F	
2SA2070		-50	-1	-2	1000	2000	200	500	-2	-0.1	-0.2	-0.3	-10	4C	
2SA2060		-50	-2	-3.5	1000	2500	200	500	-2	-0.3	-0.20	-1.0	-33	4G	
2SA2206		-80	-2	-4	1000	2500	100	200	-2	-0.5	-0.5	-1.0	-100	4K	
2SC5785	NPN single	10	2	3.5	1000	2000	400	1000	2	0.2	0.12	0.6	12	3E	
2SC5713		10	4	7	1000	2500	400	1000	2	0.5	0.15	1.6	32	2C	
2SC5819		20	1.5	2.5	1000	2000	400	1000	2	0.15	0.12	0.5	10	3D	
2SC6125		20	4	8	1000	2500	180	390	2	0.5	0.2	1.6	53	4L	
2SC5714		20	4	7	1000	2500	400	1000	2	0.5	0.15	1.6	32	2E	
2SC5810		50	1	2	1000	2000	400	1000	2	0.1	0.17	0.3	6	3C	
2SC6126		50	3	6	1000	2500	250	400	2	0.3	0.18	1.0	33	4M	
2SC5712		50	3	5	1000	2500	400	1000	2	0.3	0.14	1	20	2A	
2SC6124		80	2	4	1000	2500	100	200	2	0.5	0.5	1.0	100	4J	

Note (1): The rating applies when the transistor is mounted on an FR-4 board (Cu area = 645 mm², glass-epoxy, t = 1.6 mm). /

FR-4 基板 (Cu面積645 mm²、ガラスエポキシ、t = 1.6 mm) 実装時

Part Number	Configuration	Absolute Maximum Ratings					hFE				V _{CE(sat)} (V)			Marking	Package
		V _{CEO} (V)	I _C (A)	I _{CP} (A)	P _C (W)	P _C (W) t = 10 s	Min	Max	V _{CE} (V)	I _C (A)	Max	I _C (A)	I _B (mA)		
2SA2097	PNP single	-50	-5	-10	20 ⁽³⁾	—	200	500	-2	-0.5	-0.27	-1.6	-53	A2097	PW-Mold SC-63
TTA005		-50	-5	-10	24 ⁽⁴⁾	—	200	500	-2	-0.5	-0.27	-1.6	-53	A005	
2SA1241		-50	-2	-3	10 ⁽³⁾	—	70	240	-2	-0.5	-0.5	-1	-50	A1241	
2SA1244		-50	-5	-8	20 ⁽³⁾	—	70	240	-1	-1	-0.4	-3	-150	A1244	
TTA003		-80	-3	-5	10 ⁽³⁾	—	100	200	-2	-0.5	-0.5	-1	-100	A003	
TTA009		-80	-3	-5	12 ⁽⁴⁾	—	100	200	-2	-0.5	-0.5	-1	-100	A009	
2SC6076	NPN single	80	3	5	10 ⁽³⁾	—	180	450	2	0.5	0.5	1	100	C6076	
TTC017		80	3	5	12 ⁽⁴⁾	—	180	450	2	0.5	0.5	1	100	C017	
2SC5886A		50	5	10	20 ⁽³⁾	—	400	1000	2	0.5	0.22	1.6	32	C5886A	
TTC016		50	5	10	24 ⁽⁴⁾	—	400	1000	2	0.5	0.22	1.6	32	C016	
2SC3076		50	2	3	10 ⁽³⁾	—	70	240	2	0.5	0.5	1	50	C3076	
2SC3303		80	5	8	20 ⁽³⁾	—	70	240	1	1	0.4	3	150	C3303	
2SC6000	50	7	10	20 ⁽³⁾	—	250	400	2	2.5	0.18	2.5	83	C6000		
TPCP8507	NPN single	120	1	2	1.25 ⁽¹⁾	3	120	300	2	0.1	0.14	0.3	10	8507	
TPCP8510		120	1	2	1.1 ⁽¹⁾	2.25	120	300	2	0.1	0.14	0.3	10	8510	
TPCP8511		50	3	5	1.25 ⁽¹⁾	3	250	400	2	0.3	0.18	1	33	8511	
TPCP8505		50	3	5	1.25 ⁽¹⁾	3	400	1000	2	0.3	0.14	1	20	8505	
TPCP8504		10	2	3.5	1.2 ⁽¹⁾	2.8	400	1000	2	0.2	0.12	0.6	12	8504	
TPCP8601	PNP single	-20	-4	-7	1.3 ⁽¹⁾	3.3	200	500	-2	-0.6	-0.19	-2	-67	8601	
TPCP8602		-50	-2.5	-4	1.25 ⁽¹⁾	3	200	500	-2	-0.3	-0.2	-1	-33	8602	
TPCP8701	NPN/dual	50	3	5	0.94 ⁽¹⁾	1.77	400	1000	2	0.3	0.14	1	20	8701	
TPCP8H02 ⁽²⁾	NPN + S-MOS	30	3	5	1 ⁽¹⁾	2	250	400	2	0.3	0.14	1	33	8H02	
TPCP8901	PNP + NPN	±50	-0.8/1.0	±5	0.83 ⁽¹⁾	1.48	200/400	500/1000	±2	±0.1	-0.2/0.17	±0.3	-10/6	8901	
TPCP8902		±30	±2	±8	0.89 ⁽¹⁾	1.67	200	500	±2	±0.2	-0.2/0.14	±0.6	±20	8902	
TPCP8L01 ⁽⁵⁾	NPN Darlington + HED	120	0.9	2	0.9 ⁽¹⁾	—	2000	9000	2	1	1.5	1	1	8L01	

Note (1): The rating applies when the transistor is mounted on an FR-4 board (Cu area = 645 mm², glass-epoxy, t = 1.6 mm). /

FR-4基板 (Cu面積645 mm²、ガラスエポキシ、t = 1.6 mm) 実装時

(2): Built-in N-ch S-MOS, V_{DSS} = 20 V, I_D = 0.1 A, R_{ON} = 3 Ω Max / N-ch S-MOS内蔵、V_{DSS} = 20 V、I_D = 0.1 A、R_{ON} = 3 Ω Max

(3): T_c = 25°C

(4): T_c = 25°C, T_j = 175°C

(5): Built-in HED, V_{RRM} = 200 V, I_{F(AV)} = 1 A / HED内蔵 V_{RRM} = 200 V, I_{F(AV)} = 1 A

Low-Saturation-Voltage Transistors / 低飽和電圧トランジスタ

(Power-Mold Transistors (SC-63/64)) / (パワーモールドトランジスタ (SC-63, SC-64))

Part Number	Applications	Absolute Maximum Ratings (Ta = 25°C)				Complementary	Equivalent Product	Remarks
		V _{CEO} (V)	I _c (A)	P _c (W)	P _c ⁽¹⁾ (W)			
2SA1241	Power amplification	-50	-2.0	1.0	10	2SC3076	2SA1892	
2SC3076		50	2.0	1.0	10	2SA1241	2SC5029	
2SA1244	High-current switching	-50	-5.0	1.0	20	—	2SA1905	
2SA2097		-50	-5.0	1.0	20	—	—	High β
TTA005		-50	-5	1.2	24	—	—	T _j = 175°C
2SC5886A		50	5	1.0	20	—	—	High β, V _{CEO} = 120 V
TTC016		50	5	—	24	—	—	T _j = 175°C
2SB906		-60	-3.0	1.0	20	—	2SB834	
TTB002	Low-frequency power amplification	-60	-3.0	1.0	30	—	—	
TTA003	Switching, power amplification	-80	-3.0	—	10	—	—	
TTA009		-80	-3	—	12	—	—	T _j = 175°C
2SC6076		80	3	—	10	—	—	
TTC017		80	3	—	12	—	—	T _j = 175°C
2SC3303		80	5.0	1.0	20	—	2SC3258	
2SA2034	High-voltage switching	-400	-2	1.0	15	—	—	
2SA2184		-550	-1	—	10	—	—	
2SA2142		-600	-0.5	—	15	—	—	
2SC5548A		400	2	1.0	15	—	—	
2SC6127		800	0.05	1.0	10	—	—	
2SC6142		375	1.5	1.1	—	—	—	
TTC008		285	1.5	1.1	—	—	—	
TTC012		375	2	1.1	—	—	—	
TTC014		800	1	1.0	40	—	—	
2SC6000		High-speed switching	50	7	1.0	20	—	—

Note (1): T_c = 25°C

(PW-Mini Transistors (SC-62)) / (パワーミニトランジスタ (SC-62))

Part Number		Absolute Maximum Ratings			Electrical Characteristics										Marking ⁽¹⁾		Equivalent to TO-92MOD (TO-92)		Remarks/ Applications
		P _c (W)	V _{CEO} (V)	I _c (A)	hFE		V _{CE(sat)}			f _t									
NPN	PNP	(2)			Min	Max	V _{CE} (V)	I _c (mA)	(V)	I _c (mA)	I _B (mA)	(MHz)	V _{CE} (V)	I _c (mA)	NPN	PNP	NPN	PNP	
2SC2881	2SA1201	1	120	0.8	80	240	5	100	1.0	500	50	120	5	100	C □	D □	2SC2235	2SA965	Audio driver
—	2SA1971	1	-400	-0.5	140	400	-5	-100	-1.0	-100	-10	35	-5	-50	—	AL	—	2SA1972	High-voltage
2SC5785	—	1	10	2	400	1000	2	200	0.12	600	12	—	—	—	3E	—	—	—	Low saturation
—	2SA2066	1	-10	-2	200	500	-2	-200	-0.19	-600	-20	—	—	—	—	4E	—	—	Low saturation
2SC5713	—	1	10	4	400	1000	2	500	0.15	1600	32	—	—	—	2C	—	—	—	Low saturation
2SC5819	—	1	20	1.5	400	1000	2	150	0.12	500	10	—	—	—	3D	—	—	—	Low saturation
—	2SA2069	1	-20	-1.5	200	500	-2	-150	-0.14	-500	-17	—	—	—	—	4D	—	—	Low saturation
2SC6125	—	1	20	4	180	390	2	500	0.20	1600	53	—	—	—	4L	—	—	—	High-speed switching
2SC5714	—	1	20	4	400	1000	2	500	0.15	1600	32	—	—	—	2E	—	—	—	Low saturation
—	2SA2059	1	-20	-3	200	500	-2	-500	-0.19	-1600	-53	—	—	—	—	4F	—	—	Low saturation
2SC6126	—	1	50	3	250	400	2	300	0.18	1000	33	—	—	—	4M	—	—	—	High-speed switching
2SC5712	—	1	50	3	400	1000	2	300	0.14	1000	20	—	—	—	2A	—	—	—	Low saturation
—	2SA2060	1	-50	-2	200	500	-2	-300	-0.20	-1000	-33	—	—	—	—	4G	—	—	Low saturation
2SC5810	—	1	50	1	400	1000	2	100	0.17	300	6	—	—	—	3C	—	—	—	Low saturation
—	2SA2070	1	-50	-1	200	500	-2	-100	-0.2	-300	-10	—	—	—	—	4C	—	—	Low saturation
2SD2686	—	1	60±10	1	2000	—	2	1000	1.5	1000	1	—	—	—	3H	—	—	—	Darlington
2SC6124	2SA2206	1	80	2	100	200	2	500	0.5	1000	100	150/100	2	500	4J	4K	—	—	Low saturation
TTC005	—	1.1	285	1	100	200	5	100	1.0	600	75	—	—	—	4N	—	—	—	LED backlight
TTC013	—	1	350	0.5	100	200	5	50	0.3	160	20	—	—	—	4R	—	—	—	LED backlight

Note (1): □ in the Marking column is replaced by one of the following letters according to the hFE classification: O: Rank O, Y: Rank Y /

現品表示欄の□内には、hFE分類が入ります。(Oランク→O、Yランク→Y)

(2): The rating applies when the transistor is mounted on a glass-epoxy board (645 mm² x 1.6 mm). / ガラスエポキシ基板実装時 (645 mm² x 1.6 mm)

(TSM Transistors) / (TSM トランジスタ)

Part Number	Absolute Maximum Ratings					hFE				V _{CE(sat)} (V)			Marking	Remarks/ Applications
	V _{CEO} (V)	I _C (A)	I _{CP} (A)	P _C (mW) (1)	P _C (mW) (1) t=10s	Min	Max	V _{CE} (V)	I _C (A)	V _{CE(sat)} (V)				
										Max	I _C (A)	I _B (mA)		
2SA2058	-10	-1.5	-2.5	500	750	200	500	-2	-0.2	-0.19	-0.6	-20	WM	Low saturation
2SA2065	-20	-1.5	-2.5	500	750	200	500	-2	-0.15	-0.14	-0.5	-17	WK	Low saturation
2SA2061	-20	-2.5	-4	625	1000	200	500	-2	-0.5	-0.19	-1.6	-53	WE	Low saturation
TTA007	-50	-1	-2	700	1100	200	500	-2	-0.1	-0.2	-0.3	-10	WH	Low saturation
2SA2056	-50	-2	-3.5	625	1000	200	500	-2	-0.3	-0.20	-1.0	-33	WF	Low saturation
2SC5755	10	2	3.5	500	750	400	1000	2	0.2	0.12	0.6	12	WL	Low saturation
2SC5784	20	1.5	2.5	500	750	400	1000	2	0.15	0.12	0.5	10	WJ	Low saturation
2SC5738	20	3.5	6	625	1000	400	1000	2	0.5	0.15	1.6	32	WD	Low saturation
2SC5976	30	3	5	625	1000	250	400	2	0.3	0.14	1.0	33	WW	Ultra-high-speed switching Low saturation voltage
2SC5906	30	4	7	800	1250	200	500	2	0.5	0.2	1.6	53	WP	Ultra-high-speed switching Low saturation voltage
TTC007	50	1	2	700	1100	400	1000	2	0.1	0.12	0.3	6	WG	Low saturation
2SC5692	50	2.5	4	625	1000	400	1000	2	0.3	0.14	1.0	20	WB	Low saturation
2SC6033	50	2.5	5	625	1000	250	400	2	0.3	0.18	1.0	33	WX	Ultra-high-speed switching Low saturation voltage
2SC5703	50	4	7	800	1250	400	1000	2	0.5	0.12	1.6	32	WA	Low saturation
2SD2719	60±10	0.8	3	800	1250	2000	—	2	1.0	1.5	1	1	WV	Darlington
2SC6061	120	1	2	625	1000	120	300	2	0.1	0.14	0.3	10	WN	Low saturation

Note (1): The rating applies when the transistor is mounted on an FR4 board (Cu area = 645 mm², glass-epoxy, t = 1.6 mm). /

FR4基板 (Cu面積645 mm²、ガラスエポキシ、t = 1.6 mm) 実装時

IGBTs / IEGTs / IGBT / IEGT

IGBTs / IGBT

(Discrete IGBTs) / (ディスクリート IGBT)

Part Number	Applications	Features	Absolute Maximum Ratings (Ta = 25°C)				Package		Circuit Configuration	VCE(sat) Typ. @ Ta = 25°C			tf Typ. @ Ta = 25°C		Remarks	
			VCES (V)	Ic		Pc				VCE (V)	Ic (A)	VGE (V)	(μs)	Test Conditions		
				DC (A)	Pulsed (A)	Ta = 25°C (W)	Tc = 25°C (W)	Type								
GT15J341	Power supplies (and UPS/PFC/Motor)	High-speed switching	600	15	60	—	30	TO-220SIS	Isolation, Through-hole	(2)	1.5	15	15	0.08	Inductive load	6th generation
GT20J341				20	80	—	45	TO-220SIS	Isolation, Through-hole	(2)	1.5	20	15	0.05		6th generation
GT30J121				30	60	—	170	TO-3P(N)	Through-hole	(1)	2.0	30	15	0.05		6th generation, Tj = 175°C
GT30J341				59	120	—	230	TO-3P(N)	Through-hole	(2)	1.5	30	15	0.04		6th generation, Tj = 175°C
GT50J123 *				59	120	—	230	TO-3P(N)	Through-hole	(1)	1.9	50	15	0.04		6th generation, Tj = 175°C
GT20J121	Power factor correction	Low-frequency switching		20	80	—	40	TO-220SIS	Isolation, Through-hole	(1)	1.25	20	15	0.27	Resistive load	Partial switching converter
GT30J122A				30	100	—	120	TO-3P(N)	Through-hole	(1)	1.7	50	15	0.2		
GT40J322	IH rice cookers, IH cooktops, Microwave ovens, Induction heating equipment AC200 V	Current resonance		40	100	—	120	TO-3P(N)	Through-hole	(2)	1.7	40	15	0.2		6th generation, Tj = 175°C
GT50J341				50	100	—	200	TO-3P(N)	Through-hole	(2)	1.6	50	15	0.15		6.5th generation, Tj = 175°C
GT50JR21				50	100	—	230	TO-3P(N)	Through-hole	(2)	1.45	50	15	0.08		6.5th generation, Tj = 175°C
GT50JR22			50	100	—	230	TO-3P(N)	Through-hole	(2)	1.55	50	15	0.05	6.5th generation, Tj = 175°C		
GT50MR21			IH rice cookers, IH cooktops, Microwave ovens, Induction heating equipment AC100 V	Voltage resonance	900	50	100	—	230	TO-3P(N)	Through-hole	(2)	1.7	50		15
GT50N322A	1000	50			120	—	156	TO-3P(N)	Through-hole	(2)	2.2	60	15	0.1		High-speed
GT50N324		50			120	—	150	TO-3P(N)	Through-hole	(2)	1.9	60	15	0.11		6th generation
GT50NR21	1050	50			100	—	230	TO-3P(N)	Through-hole	(2)	1.8	50	15	0.2		6.5th generation, Tj = 175°C
GT60PR21	1100	60			120	—	333	TO-3P(N)	Through-hole	(2)	2.0	60	15	0.16	6.5th generation, Tj = 175°C	
GT40QR21	IH rice cookers, IH cooktops, Microwave ovens, Induction heating equipment AC200 V	Voltage resonance	1200	40	80	—	230	TO-3P(N)	Through-hole	(2)	1.9	40	15	0.2	6.5th generation, Tj = 175°C	
GT40RR21			1350	40	80	—	230	TO-3P(N)	Through-hole	(2)	2.0	40	15	0.21	6.5th generation, Tj = 175°C	
GT40WR21			1800	40	80	—	375	TO-3P(N)	Through-hole	(2)	2.9	40	15	0.15	6.5th generation, Tj = 175°C	

*: New product / 新製品

Circuit Configuration / 内部接続

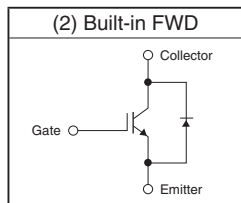
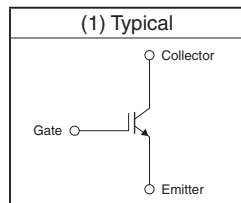

IEGTs / IEGT

(Press Pack type) / (圧接型)

Part Number	Package	Absolute Maximum Ratings			V _{CE(sat)} (V)		V _F (V)	
		V _{CES} (V)	I _C (A)	T _J (°C)	Max	Test Condition @ I _C (A)/V _{GE} (V)	Max	Test Condition @ I _C (A)/V _{GE} (V)
ST1200FXF24	PPI85B	3300	1200	125	4.2	1200/15	3.8	1200/0
ST750GXH24	PPI85B	4500	750	125	4	750/15	4.2	750/0
ST1200GXH24A	PPI85B	4500	1200	125	3.8	1200/15	—	—
ST1500GXH24	PPI125A2	4500	1500	125	4	1500/15	4.2	1500/0
ST2100GXH24A	PPI125A2	4500	2100	125	4	2100/15	—	—
ST3000GXH31A **	PPI125A2	4500	3000	150	—	3000/15	—	—

** : Under development / 開発中

(Plastic Module type) / (プラスチックモジュール型)

Part Number	Package	Absolute Maximum Ratings			V _{CE(sat)} (V)		V _F (V)		Circuit Configuration
		V _{CES} (V)	I _C (A)	T _J (°C)	Max	Test Condition @ I _C (A)/V _{GE} (V)	Max	Test Condition @ I _C (A)/V _{GE} (V)	
MG400FXF2YS53	PMI143C	3300	400	125	4.5	400/15	3.5	400/0	2 in 1
MG500FXF2YS61	PMI142C	3300	500	150	4.6	500/15	4.1	500/0	2 in 1
MG800FXF1US53	PMI143B	3300	800	125	4.5	800/15	3.5	800/0	1 in 1
MG1200FXF1US53	PMI193	3300	1200	125	4.5	1200/15	3.5	1200/0	1 in 1
MG900GXH1US53	PMI193	4500	900	125	4.7	900/15	3.8	900/0	1 in 1

(SiC Hybrid Plastic Module type) / (SiCハイブリッドプラスチックモジュール型)

Part Number	Package	Absolute Maximum Ratings			V _{CE(sat)} (V)		V _F (V)		Circuit Configuration
		V _{CES} (V)	I _C (A)	T _J (°C)	Max	Test Condition @ I _C (A)/V _{GE} (V)	Max	Test Condition @ I _C (A)/V _{GE} (V)	
MG1500FXF1US71	PMI193D	3300	1500	150	3.8	1500/15	4.6	1500/0	1 in 1

Multi-Chip Discrete Devices / 異品種混載複合デバイス

Multi-Chip Discrete Devices / 異品種混載複合デバイス

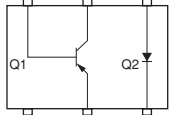
Features	Component Devices		Ratings				SM6	Internal Connections
			Breakdown Voltage (V)		Current (mA)			
High breakdown voltage PNP	Q1	2SA1587	V_{CE0}	-120	I_c	-100	HN2E04F	Independent PNP + small-signal diode 
Standard high-speed switching	Q2	1SS352	V_R	80	I_o	100		

• The internal connection diagrams only show the general configurations of the circuits.

• 内部接続図はイメージ図です。

Package Lineup / パッケージラインナップ

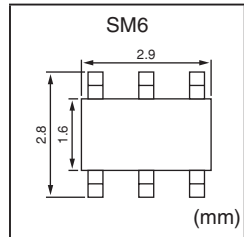

Radio-Frequency Bipolar Small-Signal Transistors / 高周波バイポーラ小信号トランジスタ

Radio-Frequency Bipolar Transistors / 高周波バイポーラトランジスタ

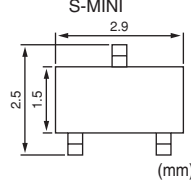
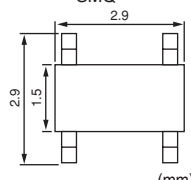
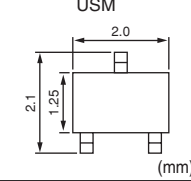
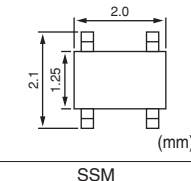
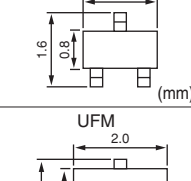
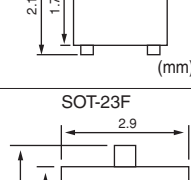
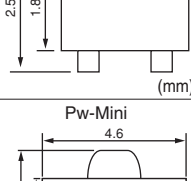
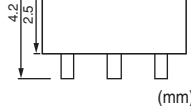
Part Number	Package	Applications	Absolute Maximum Ratings (Ta = 25°C)				Marking (1)	TO-92 Equivalent Product	Remarks
			V _{CEO} (V)	I _C (mA)	P _C (mW)	T _J (°C)			
2SC5064	S-MINI 	VHF/UHF-band low-noise amps	12	30	150	125	MA□	—	fr = 7 GHz
2SC5084		VHF/UHF-band low-noise amps	12	80	150	125	MC□	—	fr = 7 GHz
2SC5087	SMQ 	VHF/UHF-band low-noise amps	12	80	150	125	C□	—	fr = 7 GHz
2SC5087R		VHF/UHF-band low-noise amps	12	80	150	125	ZP	—	fr = 8 GHz
2SC5065	USM 	VHF/UHF-band low-noise amps	12	30	100	125	MA□	—	fr = 7 GHz
2SC5085		VHF/UHF-band low-noise amps	12	80	100	125	MC□	—	fr = 7 GHz
2SC5095		VHF/UHF-band low-noise amps	10	15	100	125	ME□	—	fr = 10 GHz
2SC5107		VHF/UHF-band oscillators	10	30	100	125	MF□	—	fr = 6 GHz
MT3S16U		UHF-band low-voltage oscillators and amps	5	60	100	125	T4	—	fr = 4 GHz
MT4S03BU	USQ 	VHF/UHF-band low-noise amps	5	40	175 (2)	150	MR	—	fr = 12 GHz
MT4S24U		VHF/UHF-band low-noise amps	5	50	175 (2)	150	R8	—	fr = 14.5 GHz
2SC4915	SSM 	FM-band radio-frequency amps	30	20	100	125	Q□	2SC1923	fr = 550 MHz
2SC5066		VHF/UHF-band low-noise amps	12	30	100	125	M1/M2	—	fr = 7 GHz
2SC5086		VHF/UHF-band low-noise amps	12	80	100	125	M5/M6	—	fr = 7 GHz
MT3S20TU	UFM 	VHF/UHF-band low-noise amps, low-distortion amps	12	80	900 (3)	150	MU	—	fr = 7 GHz
MT3S19R	SOT-23F 	VHF/UHF-band low-noise amps, low-distortion amps	6	80	320 (2)	150	T6	—	fr = 13.5 GHz
MT3S20R		VHF/UHF-band low-noise amps, low-distortion amps	12	80	320 (2)	150	MU	—	fr = 7.5 GHz
MT3S20P	Pw-Mini 	VHF/UHF-band low-noise amps, low-distortion amps	12	80	1800 (3)	150	MU	—	fr = 7 GHz

Note (1): □ in the Marking column is replaced by one of the following letters according to the hFE classification: R: Rank R, O: Rank O, Y: Rank Y /

現品表示欄の□内には、hFE分類が入ります。(Rランク→R、Oランク→O、Yランク→Y)

(2): When mounted on a glass-epoxy board / 基板実装時

(3): When mounted on a ceramic board / セラミック基板実装時

SiGe HBTs / SiGe HBT

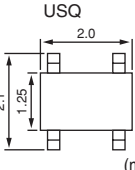
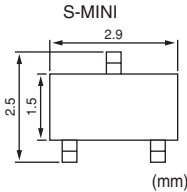
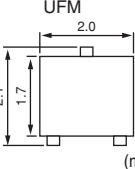
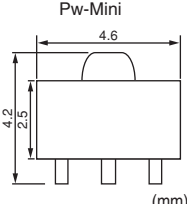
Part Number	Package	Applications	Absolute Maximum Ratings (Ta = 25°C)				Marking	Remarks
			V _{CEO} (V)	I _C (mA)	P _C (mW)	T _J (°C)		
MT4S300U	 <p>USQ (mm)</p>	UHF/SHF-band low-noise amps	4	50	100	150	P3	f _T = 26.5 GHz, high ESD immunity
MT4S301U		UHF/SHF-band low-noise amps	4	35	100	150	P4	f _T = 27.5 GHz, high ESD immunity
MT3S111	 <p>S-MINI (mm)</p>	VHF/UHF-band low-noise amps, low-distortion amps	6	100	700 ⁽¹⁾	150	R5	f _T = 11.5 GHz
MT3S113		VHF/UHF-band low-noise amps, low-distortion amps	5.3	100	800 ⁽¹⁾	150	R7	f _T = 12.5 GHz
MT3S111TU	 <p>UFM (mm)</p>	VHF/UHF-band low-noise amps, low-distortion amps	6	100	800 ⁽¹⁾	150	R5	f _T = 10 GHz
MT3S113TU			5.3	100	900 ⁽¹⁾	150	R7	f _T = 11.2 GHz
MT3S111P	 <p>Pw-Mini (mm)</p>	VHF/UHF-band low-noise amps, low-distortion amps	6	100	1000 ⁽¹⁾	150	R5	f _T = 8 GHz
MT3S113P			5.3	100	1600 ⁽¹⁾	150	R7	f _T = 7.7 GHz

Note (1): When mounted on a ceramic board / セラミック基盤実装時

RESTRICTIONS ON PRODUCT USE

Toshiba Corporation and its subsidiaries and affiliates are collectively referred to as "TOSHIBA". Hardware, software and systems described in this document are collectively referred to as "Product".

- ▶ TOSHIBA reserves the right to make changes to the information in this document and related Product without notice.
 - ▶ This document and any information herein may not be reproduced without prior written permission from TOSHIBA. Even with TOSHIBA's written permission, reproduction is permissible only if reproduction is without alteration/omission.
 - ▶ Though TOSHIBA works continually to improve Product's quality and reliability, Product can malfunction or fail. Customers are responsible for complying with safety standards and for providing adequate designs and safeguards for their hardware, software and systems which minimize risk and avoid situations in which a malfunction or failure of Product could cause loss of human life, bodily injury or damage to property, including data loss or corruption. Before customers use the Product, create designs including the Product, or incorporate the Product into their own applications, customers must also refer to and comply with (a) the latest versions of all relevant TOSHIBA information, including without limitation, this document, the specifications, the data sheets and application notes for Product and the precautions and conditions set forth in the "TOSHIBA Semiconductor Reliability Handbook" and (b) the instructions for the application with which the Product will be used with or for. Customers are solely responsible for all aspects of their own product design or applications, including but not limited to (a) determining the appropriateness of the use of this Product in such design or applications; (b) evaluating and determining the applicability of any information contained in this document, or in charts, diagrams, programs, algorithms, sample application circuits, or any other referenced documents; and (c) validating all operating parameters for such designs and applications. **TOSHIBA ASSUMES NO LIABILITY FOR CUSTOMERS' PRODUCT DESIGN OR APPLICATIONS.**
 - ▶ **PRODUCT IS NEITHER INTENDED NOR WARRANTED FOR USE IN EQUIPMENTS OR SYSTEMS THAT REQUIRE EXTRAORDINARILY HIGH LEVELS OF QUALITY AND/OR RELIABILITY, AND/OR A MALFUNCTION OR FAILURE OF WHICH MAY CAUSE LOSS OF HUMAN LIFE, BODILY INJURY, SERIOUS PROPERTY DAMAGE AND/OR SERIOUS PUBLIC IMPACT ("UNINTENDED USE").** Except for specific applications as expressly stated in this document, Unintended Use includes, without limitation, equipment used in nuclear facilities, equipment used in the aerospace industry, lifesaving and/or life supporting medical equipment, equipment used for automobiles, trains, ships and other transportation, traffic signaling equipment, equipment used to control combustions or explosions, safety devices, elevators and escalators, and devices related to power plant. **IF YOU USE PRODUCT FOR UNINTENDED USE, TOSHIBA ASSUMES NO LIABILITY FOR PRODUCT.** For details, please contact your TOSHIBA sales representative or contact us via our website.
 - ▶ Do not disassemble, analyze, reverse-engineer, alter, modify, translate or copy Product, whether in whole or in part.
 - ▶ Product shall not be used for or incorporated into any products or systems whose manufacture, use, or sale is prohibited under any applicable laws or regulations.
 - ▶ The information contained herein is presented only as guidance for Product use. No responsibility is assumed by TOSHIBA for any infringement of patents or any other intellectual property rights of third parties that may result from the use of Product. No license to any intellectual property right is granted by this document, whether express or implied, by estoppel or otherwise.
 - ▶ **ABSENT A WRITTEN SIGNED AGREEMENT, EXCEPT AS PROVIDED IN THE RELEVANT TERMS AND CONDITIONS OF SALE FOR PRODUCT, AND TO THE MAXIMUM EXTENT ALLOWABLE BY LAW, TOSHIBA (1) ASSUMES NO LIABILITY WHATSOEVER, INCLUDING WITHOUT LIMITATION, INDIRECT, CONSEQUENTIAL, SPECIAL, OR INCIDENTAL DAMAGES OR LOSS, INCLUDING WITHOUT LIMITATION, LOSS OF PROFITS, LOSS OF OPPORTUNITIES, BUSINESS INTERRUPTION AND LOSS OF DATA, AND (2) DISCLAIMS ANY AND ALL EXPRESS OR IMPLIED WARRANTIES AND CONDITIONS RELATED TO SALE, USE OF PRODUCT, OR INFORMATION, INCLUDING WARRANTIES OR CONDITIONS OF MERCHANTABILITY, FITNESS FOR A PARTICULAR PURPOSE, ACCURACY OF INFORMATION, OR NONINFRINGEMENT.**
 - ▶ Product may include products using GaAs (Gallium Arsenide). GaAs is harmful to humans if consumed or absorbed, whether in the form of dust or vapor. Handle with care and do not break, cut, crush, grind, dissolve chemically or otherwise expose GaAs in Product.
 - ▶ Do not use or otherwise make available Product or related software or technology for any military purposes, including without limitation, for the design, development, use, stockpiling or manufacturing of nuclear, chemical, or biological weapons or missile technology products (mass destruction weapons). Product and related software and technology may be controlled under the applicable export laws and regulations including, without limitation, the Japanese Foreign Exchange and Foreign Trade Law and the U.S. Export Administration Regulations. Export and re-export of Product or related software or technology are strictly prohibited except in compliance with all applicable export laws and regulations.
 - ▶ Product may include products subject to foreign exchange and foreign trade control laws.
 - ▶ Please contact your TOSHIBA sales representative for details as to environmental matters such as the RoHS compatibility of Product. Please use Product in compliance with all applicable laws and regulations that regulate the inclusion or use of controlled substances, including without limitation, the EU RoHS Directive. **TOSHIBA ASSUMES NO LIABILITY FOR DAMAGES OR LOSSES OCCURRING AS A RESULT OF NONCOMPLIANCE WITH APPLICABLE LAWS AND REGULATIONS.**
- In addition to the above, the following are applicable only to development tools.
- ▶ Though TOSHIBA works continually to improve Product's quality and reliability, Product can malfunction or fail. Use the Product in a way which minimizes risk and avoid situations in which a malfunction or failure of Product could cause loss of human life, bodily injury or damage to property, including data loss or corruption. For using the Product, customers must also refer to and comply with the latest versions of all relevant TOSHIBA information, including without limitation, this document, the instruction manual, the specifications, the data sheets for Product.
 - ▶ Product is provided solely for the purpose of performing the functional evaluation of a semiconductor product. Please do not use Product for any other purpose, including without limitation, evaluation in high or low temperature or humidity, and verification of reliability.
 - ▶ Do not incorporate Product into your products or system. Products are for your own use and not for sale, lease or other transfer.

製品取り扱い上のお願い

株式会社東芝およびその子会社ならびに関係会社を以下「当社」といいます。
本資料に掲載されているハードウェア、ソフトウェアおよびシステムを以下「本製品」といいます。

- ▶ 本製品に関する情報等、本資料の掲載内容は、技術の進歩などにより予告なしに変更されることがあります。
- ▶ 文書による当社の事前の承諾なしに本資料の転載複製を禁じます。また、文書による当社の事前の承諾を得て本資料を転載複製する場合でも、記載内容に一切変更を加えたり、削除したりしないでください。
- ▶ 当社は品質、信頼性の向上に努めていますが、半導体・ストレージ製品は一般に誤作動または故障する場合があります。本製品をご使用頂く場合は、本製品の誤作動や故障により生命・身体・財産が侵害されることのないよう、お客様の責任において、お客様のハードウェア・ソフトウェア・システムに必要な安全設計を行うことをお願いします。なお、設計および使用に際しては、本製品に関する最新の情報（本資料、仕様書、データシート、アプリケーションノート、半導体信頼性ハンドブックなど）および本製品が使用される機器の取扱説明書、操作説明書などをご確認の上、これに従ってください。また、上記資料などに記載の製品データ、図、表などに示す技術的な内容、プログラム、アルゴリズムその他応用回路例などの情報を使用する場合は、お客様の製品単独およびシステム全体で十分に評価し、お客様の責任において適用可否を判断してください。
- ▶ 本製品は、特別に高い品質・信頼性が要求され、またはその故障や誤作動が生命・身体に危害を及ぼす恐れ、膨大な財産損害を引き起こす恐れ、もしくは社会に深刻な影響を及ぼす恐れのある機器（以下“特定用途”という）に使用されることは意図されていませんし、保証もされていません。特定用途には原子力関連機器、航空・宇宙機器、医療機器（ヘルスケア除く）、車載・輸送機器、列車・船舶機器、交通信号機器、燃焼・爆発制御機器、各種安全関連機器、昇降機器、発電関連機器などが含まれますが、本資料に個別に記載する用途は除きます。特定用途に使用された場合には、当社は一切の責任を負いません。なお、詳細は当社営業窓口まで、または当社Webサイトのお問い合わせフォームからお問い合わせください。
- ▶ 本製品を分解、解析、リバースエンジニアリング、改造、改変、翻案、複製等しないでください。
- ▶ 本製品を、国内外の法令、規則及び命令により、製造、使用、販売を禁止されている製品に使用することはできません。
- ▶ 本資料に掲載してある技術情報は、製品の代表的動作・応用を説明するためのもので、その使用に際して当社及び第三者の知的財産権その他の権利に対する保証または実施権の許諾を行うものではありません。
- ▶ 別途、書面による契約またはお客様と当社が合意した仕様書がない限り、当社は、本製品および技術情報に関して、明示的にも黙示的にも一切の保証（機能動作の保証、商品性の保証、特定目的への合致の保証、情報の正確性の保証、第三者の権利の非侵害保証を含むがこれに限らない。）をしておりません。
- ▶ 本製品にはGaAs（ガリウムヒ素）が使われているものがあります。その粉末や蒸気等は人体に対し有害ですので、破壊、切断、粉碎や化学的な分解はしないでください。
- ▶ 本製品、または本資料に掲載されている技術情報を、大量破壊兵器の開発等の目的、軍事利用の目的、あるいはその他軍事事務の目的で使用しないでください。また、輸出に際しては、「外国為替及び外国貿易法」、「米国輸出管理規則」等、適用ある輸出関連法令を遵守し、それらの定めるところにより必要な手続を行ってください。
- ▶ 本製品には、外国為替及び外国貿易法により、輸出または海外への提供が規制されているものがあります。
- ▶ 本製品のRoHS適合性など、詳細につきましては製品個別に必ず当社営業窓口までお問い合わせください。本製品のご使用に際しては、特定の物質の含有・使用を規制するRoHS指令等、適用ある環境関連法令を十分調査の上、かかる法令に適合するようご使用ください。お客様がかかる法令を遵守しないことにより生じた損害に関して、当社は一切の責任を負いかねます。

上記に加えて、以下は開発ツールのみ適用されます。

- ▶ 当社は品質、信頼性の向上に努めていますが、本製品は誤作動または故障する場合があります。本製品をご使用頂く場合は、本製品の誤作動や故障により生命・身体・財産が侵害されることのないようご使用ください。本製品をご使用頂く場合は、本製品に関する最新の情報（本資料、取扱説明書、仕様書、データシートなど）をご確認の上、これに従ってください。
- ▶ 本製品は、半導体製品の機能評価に使用されることを意図しています。機能評価以外の目的（温度・湿度特性評価、信頼性評価など）には使用しないでください。
- ▶ 本製品をお客様の製品に組み込まないでください。また、本製品を販売、譲渡、貸与等しないでください。

TOSHIBA

東芝デバイス&ストレージ株式会社

最新のデータシートやカタログを下記ホームページでも公開しています。

<https://toshiba.semicon-storage.com/>

【お問い合わせ先】