

TOSHIBA CMOS Linear Integrated Circuit Silicon Monolithic

TCTH0xxxE Series

Thermoflagger™ (Over Temperature Detection IC)

The TCTH0xxxE series are the CMOS process IC outputs abnormal-state signal on detecting over temperature as the resistor value changing of external PTC Thermistor.

Output current to PTC thermistor is 1 μ A (Typ.) and whole current consumption is 1.8 μ A (Typ.), low consumption operation is realised. (TCTH01xxE)

Selectable Push-pull type, or Open-drain type for FLAG signal output by product.

Also, Selectable Auto retry type if PTC thermistor temperature goes down back to lower than threshold, or Latch the abnormal signal type.

IC package is ESV (1.6 mm x 1.6 mm x 0.55 mm).

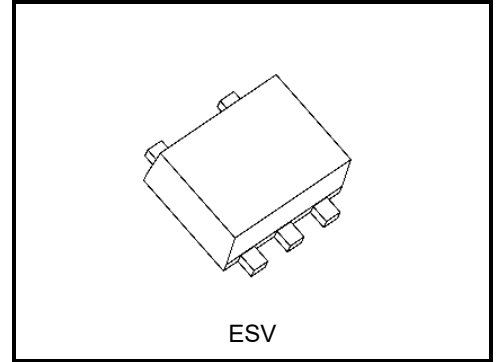

Weight: 2.98 mg (Typ.)

Application (Ex)

- Notebook PC, Mobile equipment, home appliance, Industry equipment etc. for over temperature detection.

Feature

- Selectable PTCO output current
 - IPTCO = 1 μ A (TCTH01xxE, Typ.)
 - IPTCO = 10 μ A (TCTH02xxE, Typ.)
- High PTCO output current accuracy $\pm 8\%$ ($V_{DD} = 3.3$ V, 25 $^{\circ}$ C)
- Low current consumption
 - I_{DD} = 1.8 μ A (TCTH01xxE, Typ.)
 - I_{DD} = 11.3 μ A (TCTH02xxE, Typ.)
- FLAG signal latch function (TCTH0x2xE)
- FLAG signal output (PTCGOOD)
 - TCTH0xxAE: Push-pull type
 - TCTH0xxBE: Open-drain type
- Standard package ESV (SOT-553) (1.6 mm x 1.6 mm x 0.55 mm)

“Thermoflagger™” is a trademark of Toshiba Electronic Devices & Storage Corporation.

Start of commercial production
2023-02

1. Absolute Maximum Ratings (Ta = 25 °C)

Characteristics	Symbol	Ratings	Unit	
Supply Voltage	V _{DD}	-0.3 to 6.0	V	
PTCO Voltage	V _{PTCO}	-0.3 to V _{DD} + 0.3 ≤ 6.0	V	
PTCGOOD Voltage	V _{PTCGOOD}	TCTH0xxAE	-0.3 to V _{DD} + 0.3 ≤ 6.0	V
		TCTH0xxBE	-0.3 to 6.0	V
RESET Voltage	V _{RESET}	-0.3 to V _{DD} + 0.3 ≤ 6.0	V	
Power dissipation	P _D	150 (Note 1)	mW	
		320 (Note 2)		
Junction Temperature	T _j	150	°C	
Storage Temperature	T _{stg}	-55 to 150	°C	

Note: Using continuously under heavy loads (e.g. the application of high temperature/current/voltage and the significant changing in temperature, etc.) may cause this product to reduce the reliability significantly even if the operating conditions (i.e. operating temperature/current/voltage, etc.) are within the absolute maximum ratings. Please design appropriately upon reviewing the Toshiba Semiconductor Reliability Handbook (“Handling Precautions”/“Derating Concept and Methods”) and individual reliability data (i.e. reliability test report and estimated failure rate, etc).

Note 1: Unit Rating

Note 2: Rating at mounting on a board

(FR4 board dimension: 30 mm x 30 mm x 0.8 mm)

2. Operating Ranges

Characteristics	Symbol	Operating Ranges	Unit	
Supply Voltage	V _{DD}	1.7 to 5.5	V	
PTCGOOD Output Voltage	V _{PTCGOOD}	TCTH0xxAE	0 to V _{DD}	V
		TCTH0xxBE	0 to 5.5	V
RESET Voltage	V _{RESET}	0 to V _{DD}	V	
Operation Temperature	T _{opr}	-40 to 125	°C	

Note3: There is possibility for significant negative affect for reliability, if this product used long time on the state includes limit or very close condition on Operating ranges. Exposure to such conditions may adversely impact product reliability lifetime average junction temperature of 107 °C.

3. Pin Assignment (Top view)

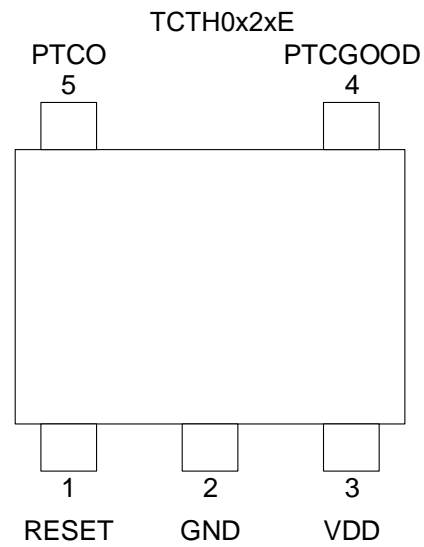
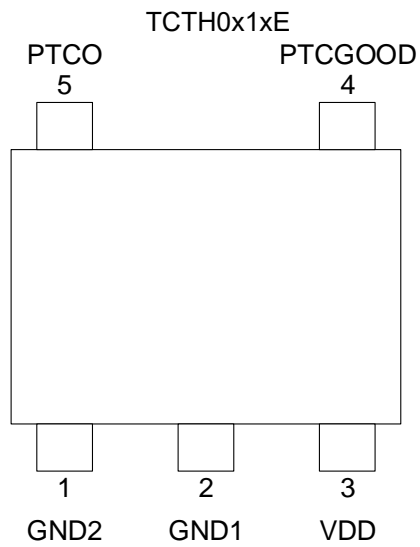

Note4: All GND pin must connect to the system GND.

4. Top Marking (Top view)

Example: TCTH022BE

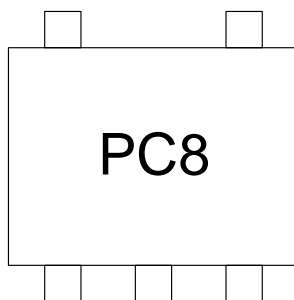

5. List for Product name, Output type, Top marking

Product name	PTCO output current	FLAG signal latch function	Output type	Top Marking
TCTH011AE	1 μ A (Typ.)	—	Push-pull	PC1
TCTH012AE	1 μ A (Typ.)	✓ included	Push-pull	PC2
TCTH021AE	10 μ A (Typ.)	—	Push-pull	PC3
TCTH022AE	10 μ A (Typ.)	✓ included	Push-pull	PC4
TCTH011BE	1 μ A (Typ.)	—	Open-drain	PC5
TCTH012BE	1 μ A (Typ.)	✓ included	Open-drain	PC6
TCTH021BE	10 μ A (Typ.)	—	Open-drain	PC7
TCTH022BE	10 μ A (Typ.)	✓ included	Open-drain	PC8

6. Block diagram

TCTH0x1AE

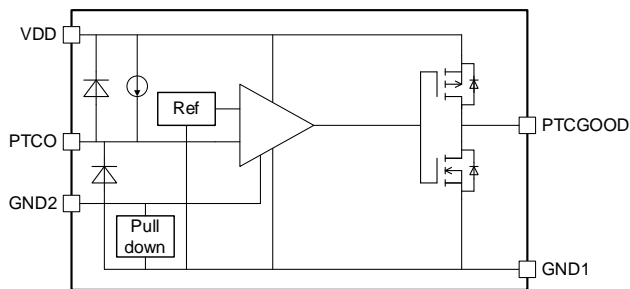

TCTH0x2AE

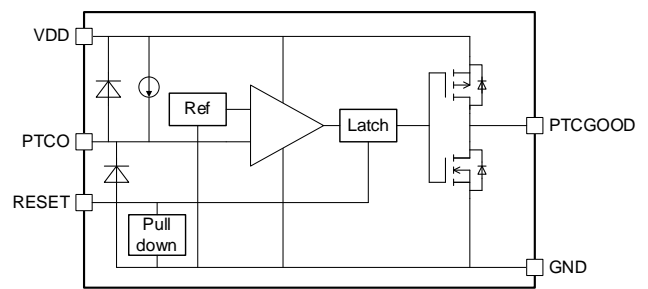

TCTH0x1BE

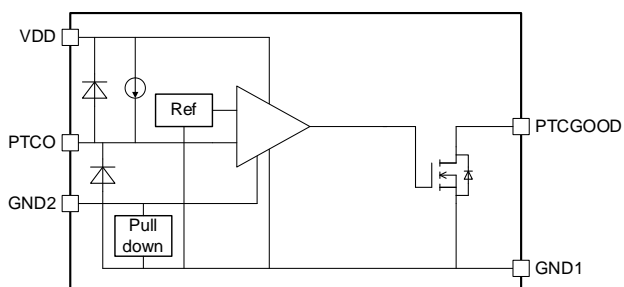

TCTH0x2BE

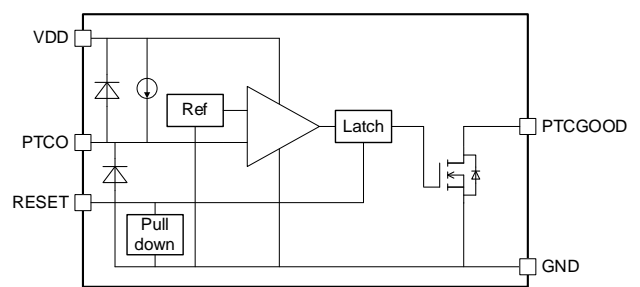

7. Pin Description

Pin name	Description
VDD	Power supply pin.
GND	Ground level pin.
RESET	Reset pin release Latching function for FLAG signal.
PTCO	Constant-current output pin. Single or several pcs of PTC thermistor(s) for temperature detecting is(are) to be connected in series between PTCO and GND. Do not apply a voltage exceeding 1 V from outside. If a high voltage is applied from the outside for a long time, the Detect Voltage (V_{DET}) characteristics may be changed.
PTCGOOD	FLAG signal output pin.

8. Operation list

8-1. TCTH0x1AE (without RESET)

V_{DD}	V_{PTCO}	PTCGOOD
$V_{DD} < V_{UVLO}$	X	Indefinite
$V_{DD} \geq V_{UVLO}$	$V_{PTCO} < V_{DET}$	H
$V_{DD} \geq V_{UVLO}$	$V_{PTCO} \geq V_{DET}$	L

X : Don't care,

8-2. TCTH0x1BE (without RESET)

V_{DD}	V_{PTCO}	PTCGOOD
$V_{DD} < V_{UVLO}$	X	Indefinite
$V_{DD} \geq V_{UVLO}$	$V_{PTCO} < V_{DET}$	Hi-Z
$V_{DD} \geq V_{UVLO}$	$V_{PTCO} \geq V_{DET}$	L

X : Don't care,

Hi-Z : High-impedance

8-3. TCTH0x2AE (RESET included)

V_{DD}	RESET	V_{PTCO}	PTCGOOD
$V_{DD} < V_{UVLO}$	X	X	Indefinite
$V_{DD} \geq V_{UVLO}$	H	X	H
$V_{DD} \geq V_{UVLO}$	L	$V_{PTCO} < V_{DET}$	H
$V_{DD} \geq V_{UVLO}$	L	$V_{PTCO} \geq V_{DET}$	L (Latch)

X : Don't care,

8-4. TCTH0x2BE (RESET included)

V_{DD}	RESET	V_{PTCO}	PTCGOOD
$V_{DD} < V_{UVLO}$	X	X	Indefinite
$V_{DD} \geq V_{UVLO}$	H	X	Hi-Z
$V_{DD} \geq V_{UVLO}$	L	$V_{PTCO} < V_{DET}$	Hi-Z
$V_{DD} \geq V_{UVLO}$	L	$V_{PTCO} \geq V_{DET}$	L (Latch)

X : Don't care,

Hi-Z : High-impedance

PTCGOOD latch will be released if the RESET inputs "H" or re-input using the V_{DD} .

9. Electrical characteristics

(Unless otherwise specified, $V_{DD} = 3.3\text{ V}$)

Characteristics	symbol	Test Condition	$T_j = 25\text{ }^\circ\text{C}$			$T_j = -40\text{ to }125\text{ }^\circ\text{C}$ (Note 5)		Unit
			Min.	Typ.	Max.	Min.	Max.	
PTCO output current	IPTCO	TCTH01xxE, $V_{DD} = 3.3\text{ V}$	0.92	1.00	1.08	0.76	1.27	μA
		TCTH01xxE, $V_{DD} = 1.7\text{ V to }5.5\text{ V}$	0.80	1.00	1.22	0.72	1.32	μA
		TCTH02xxE, $V_{DD} = 3.3\text{ V}$	9.2	10.0	10.8	7.6	12.7	μA
		TCTH02xxE, $V_{DD} = 1.7\text{ V to }5.5\text{ V}$	8.0	10.0	12.2	7.2	13.2	μA
Detect Voltage	V_{DET}		0.42	0.50	0.58	0.36	0.64	V
Hysteresis Voltage	V_{DETHYS}	TCTH0x1xE	—	0.1	—	—	—	V
Response time	t_{DET1}	PTCO terminal voltage : 1 V to 10 mV	—	17	—	—	—	μs
	t_{DET2}	PTCO terminal voltage : 1 V to 10 mV, TCTH0x1xE	—	214	—	—	—	μs
Current Consumption	I_{DD1U}	TCTH01xxE	—	1.8	2.4	—	2.6	μA
	I_{DD10U}	TCTH02xxE	—	11.3	14.7	—	16.5	μA
UVLO voltage	V_{UVLO}		—	1.5	—	—	—	V
Operation MASK time	t_{ope}		—	20	—	—	—	μs
Threshold of RESET pin High level	$V_{IHRESET}$		0.84	—	V_{DD}	1.00	V_{DD}	V
Pull-down current at RESET pin	I_{RESET}		—	0.04	—	—	—	μA
PTCGOOD High level output voltage	V_{OH}	TCTH0xxAE, $I_{PTCGOOD} = -4\text{ mA}$	3.03	—	—	—	—	V
PTCGOOD Low level output voltage	V_{OL}	$I_{PTCGOOD} = 4\text{ mA}$	—	—	0.2	—	—	V

Note 5: These parameters are guaranteed by design.

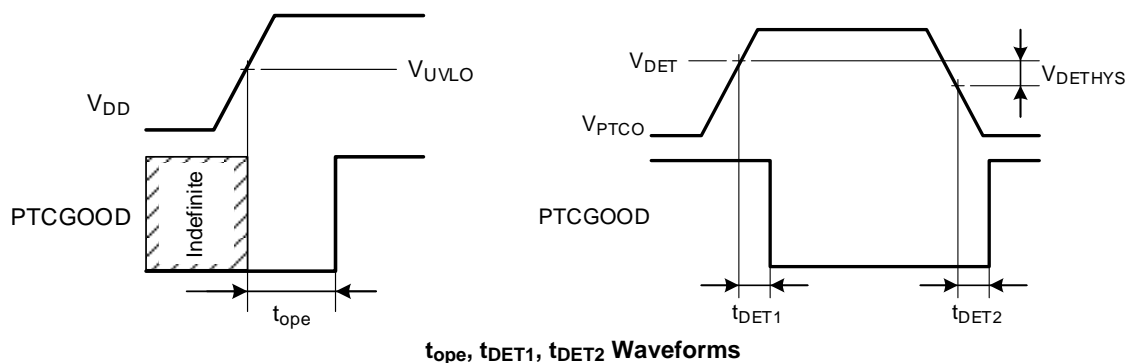

10. Application Note

10.1. Operation description (TCTH0x1AE, TCTH0x1BE)

PTCO output current and PTC Thermistor(s) resistance, externally placed near the heat source determines the voltage level on PTCO pin. When this terminal-voltage exceeds the specified voltage, immediately PTCGOOD pin outputs “Low”.

When PTCO pin voltage become lower than the specified voltage, automatically returns and PTCGOOD pin outputs “High” (TCTH0x1AE), or “High-impedance” (TCTH0x1BE).

Detecting temperature varies on selection of PTC thermistor(s). If the detection on higher temperature than this IC operation range is necessary, take care the PCB designing and keep enough distance between PTC Thermistor(s) and this IC to avoid heat propagation to this IC.

TCTH0x1AE

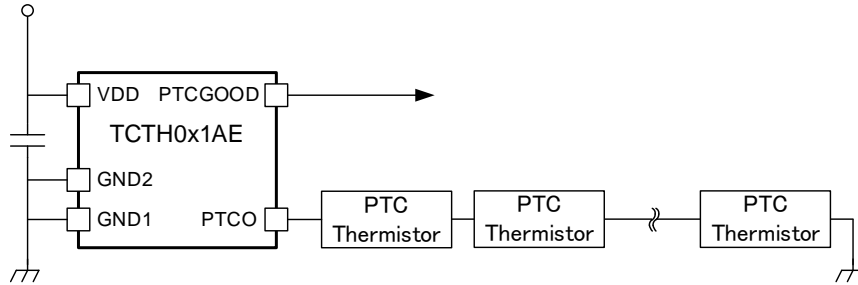

TCTH0x1BE

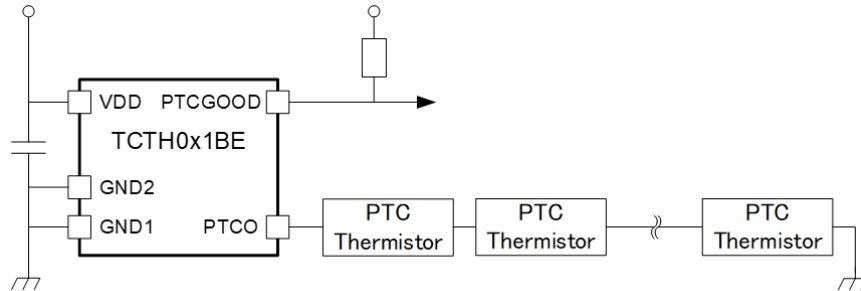

TCTH0x1xE Timing chart

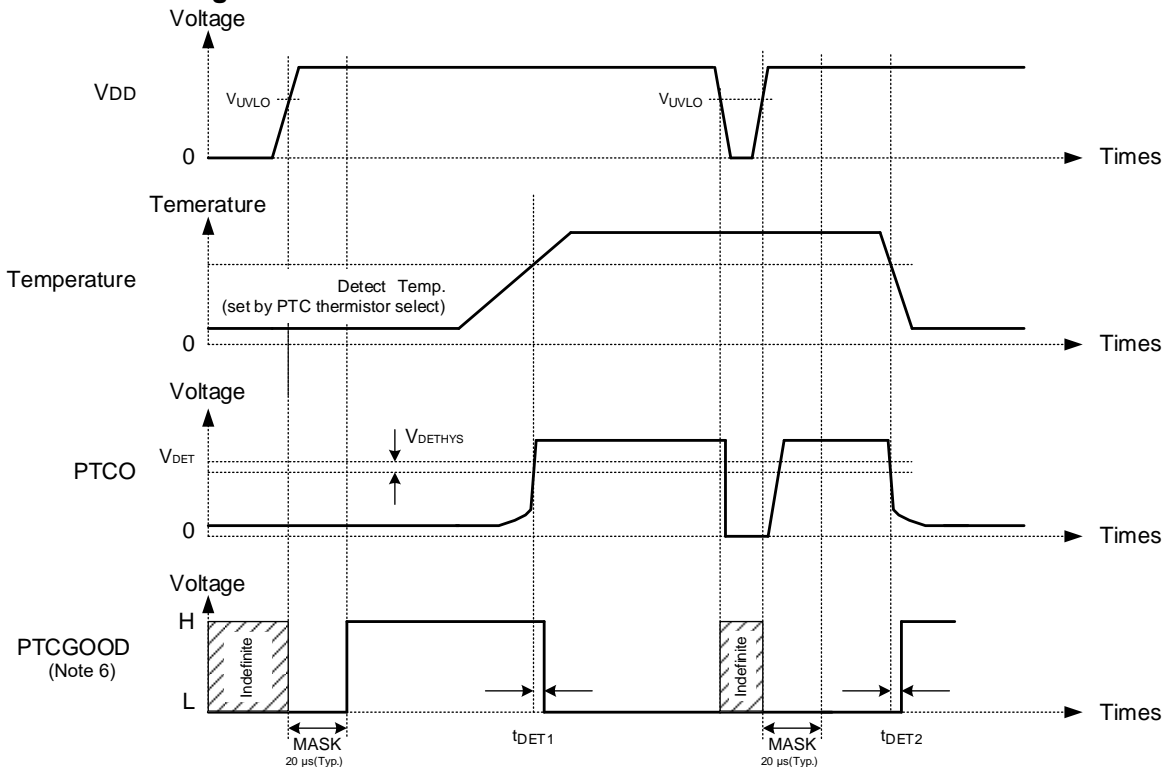

Note 6: TCTH0x1BE is using Open-drain output.

Therefore, PTCGOOD pin of TCTH0x1BE outputs High-impedance instead of “High”.

10.2. Operation description (TCTH0x2AE, TCTH0x2BE)

PTCO output current and PTC Thermistor(s) resistance, externally placed near the heat source determines the voltage level on PTCO pin. When this terminal-voltage exceeds the specified voltage, immediately PTCGOOD pin outputs “Low” and keep the output state.

Input the “High” signal into RESET pin, to cancel this PTCGOOD latch signal.

If “High” signal is input to RESET pin, this device is in reset state, PTCGOOD pin outputs “High” (TCTH0x2AE), or “High-impedance” (TCTH0x2BE).

Detecting temperature varies on selection of PTC thermistor(s). If the detection on higher temperature than this IC operation range is necessary, take care the PCB designing and keep enough distance between PTC Thermistor(s) and this IC to avoid heat propagation to this IC.

TCTH0x2AE

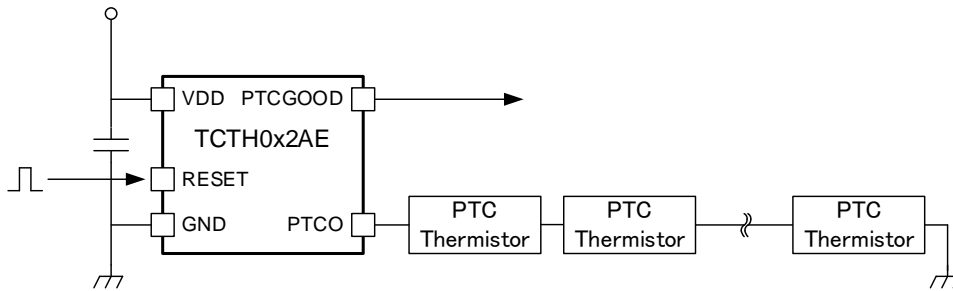

TCTH0x2BE

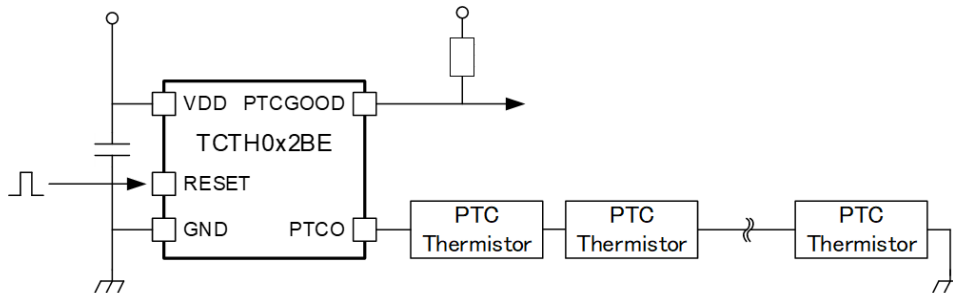

TCTH0x2xE Timing chart

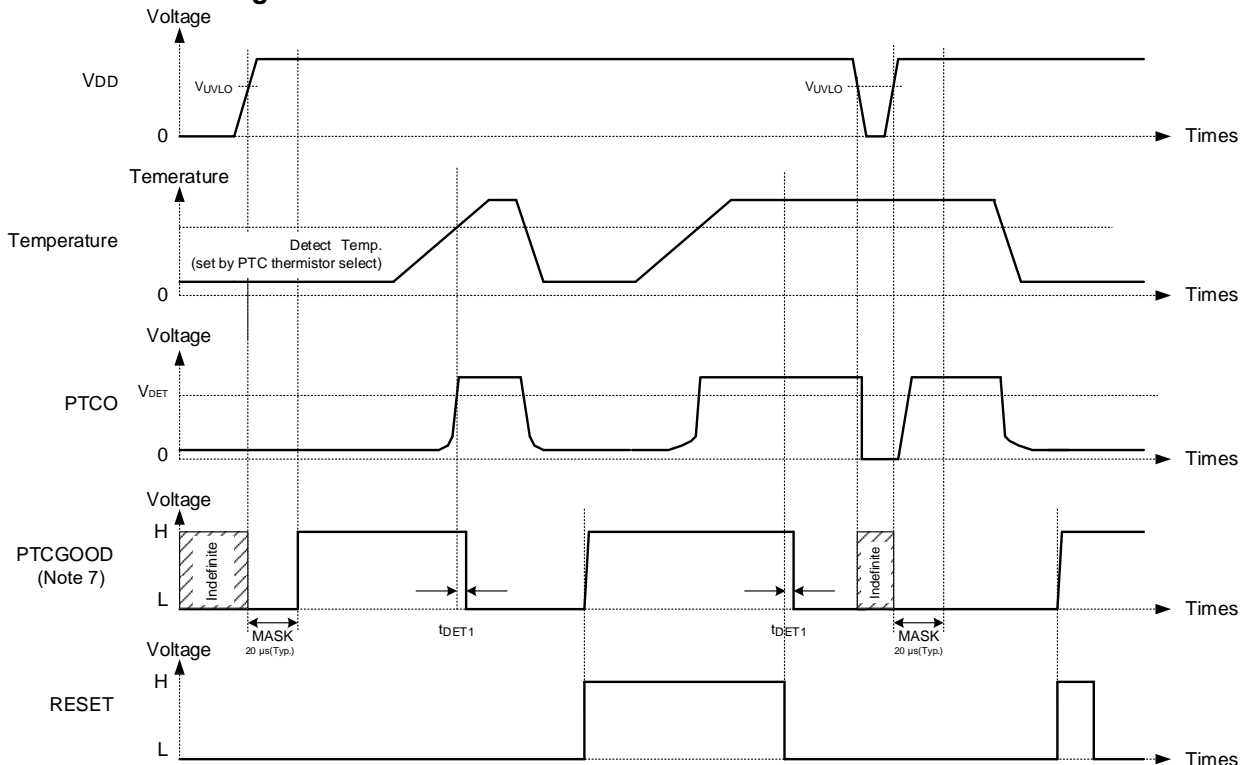

Note 7: TCTH0x2BE is using Open-drain output.

Therefore, PTCGOOD pin of TCTH0x2BE outputs High-impedance instead of “High”.

10.3. How to choose PTC thermistor

The resistor value of PTC thermistor is increased when the temperature exceeds threshold. PTCO voltage (V_{PTCO}) generates with PTC thermistor characteristics and PTCO output current. PTCGOOD outputs “Low” when PTC PTCO voltage is higher than the detect voltage (V_{DET}).

There are 2 types of products, have different PTCO output current. Select PTC thermistor matches each PTCO output current. Refer to the following.

10.3.1. Usage with single PTC thermistor

Refer to the following to select a PTC thermistor for IC detecting when resistance of PTC thermistor becomes α times the one on normal conditions.

$$\frac{V_{DET} \text{ (Max.)}}{I_{PTCO} \text{ (Min.)} \times \alpha} < \text{PTC thermistor resistance at normal operation} < \frac{V_{DET} \text{ (Min.)}}{I_{PTCO} \text{ (Max.)} \times \beta}$$

α : The rate of changing PTC thermistor resistance ($\alpha = \frac{\text{resistance at over temperature operation}}{\text{resistance at normal operation}}$)

β : V_{DET} margin coefficient, Set with guideline as $10 \leq \beta \leq \alpha/4$

Note: Design for PTC thermistor resistance variation and margins.

Ex.) Reference PTC thermistor resistance for single pc.

Product name	PTCO output current (Typ.)	PTC thermistor resistance (25 °C)	
		$\alpha = 50, \beta = 10$	$\alpha = 100, \beta = 10$
TCTH01xxE	1 μ A	17.8 k Ω to 27 k Ω	9.1 k Ω to 27 k Ω
TCTH02xxE	10 μ A	1.78 k Ω to 2.7 k Ω	910 Ω to 2.7 k Ω

10.3.2. Using several (N pcs) PTC thermistors

When using several PTC thermistors, select the thermistors with same resistance value at 25 °C. if using different thermistors in same system, the IC does not correctly detect the setting temperature as blow. Maximum number of PTC thermistors can be connected is around 30 pcs.

Ex.) Refer next formula to select the PTC thermistors, to detect with this IC when the resistor value changed to α times when one of the PTC thermistors is overheated, using N pcs of PTC thermistors have same resistor value at 25 °C.

$$\frac{V_{DET} \text{ (Max.)}}{I_{PTCO} \text{ (Min.)} \times (\alpha + N - 1)} < \text{PTC thermistor resistance at normal operation} < \frac{V_{DET} \text{ (Min.)}}{I_{PTCO} \text{ (Max.)} \times \beta \times N}$$

N: PTC thermistor quantity

α : The rate of changing PTC thermistor resistance ($\alpha = \frac{\text{resistance at over temperature operation}}{\text{resistance at normal operation}}$)

Set α to be at least $(4 + N/2) \times \beta$ or more, as guideline.

β : V_{DET} margin coefficient, set β to be $N + 10$ as guideline.

Note: Design for PTC thermistor resistance variation and margins.

If in a condition that multiple PTC thermistors are to be overheated at the same time, the combined resistance after overheating should be considered to set the system, to avoid false positive of the IC on the temperature below detecting temperature.

Ex.) Reference PTC thermistor resistance using several (N) pcs.

Product name	PTCO output current (Typ.)	PTC thermistor resistance (25 °C)	
		$N = 10, \alpha = 180, \beta = 20$	$N = 10, \alpha = 300, \beta = 20$ (when α is increased)
TCTH01xxE	1 μ A	4.7 k Ω to 9.4 k Ω	2.8 k Ω to 9.4 k Ω
TCTH02xxE	10 μ A	470 Ω to 940 Ω	280 Ω to 940 Ω

10.4. Power Dissipation

Both unit and board mounted power dissipation ratings for TCTH0 series are available in the Absolute Maximum Ratings table.

Power dissipation is measured on the board shown below.

[The Board Condition]

FR4 board dimension: 30 mm × 30 mm × 0.8 mm

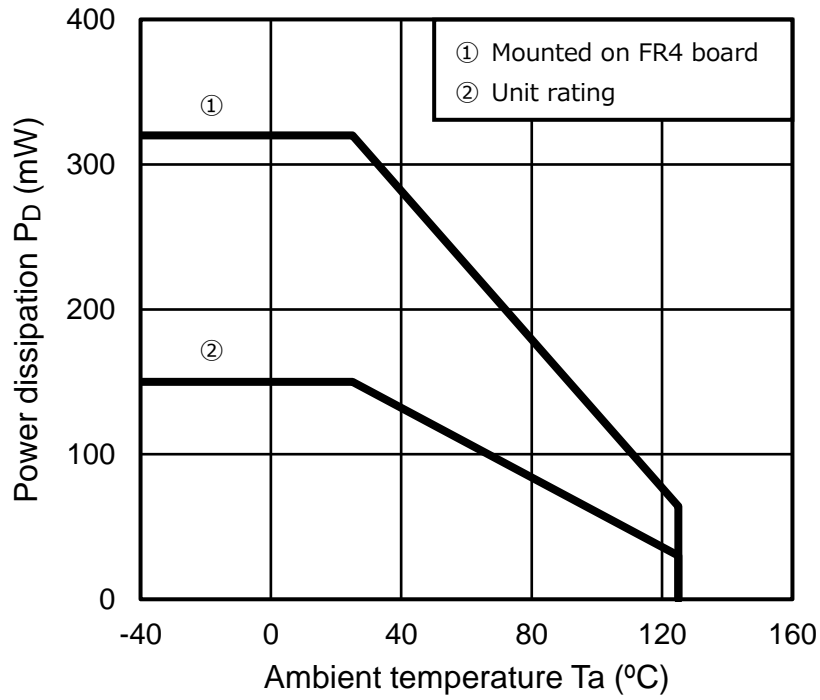

11. Representative Typical Characteristics

Unless otherwise specified, $V_{DD} = 3.3\text{ V}$, $V_{PTCO} = 0.61\text{ V}$, $T_j = 25\text{ }^\circ\text{C}$

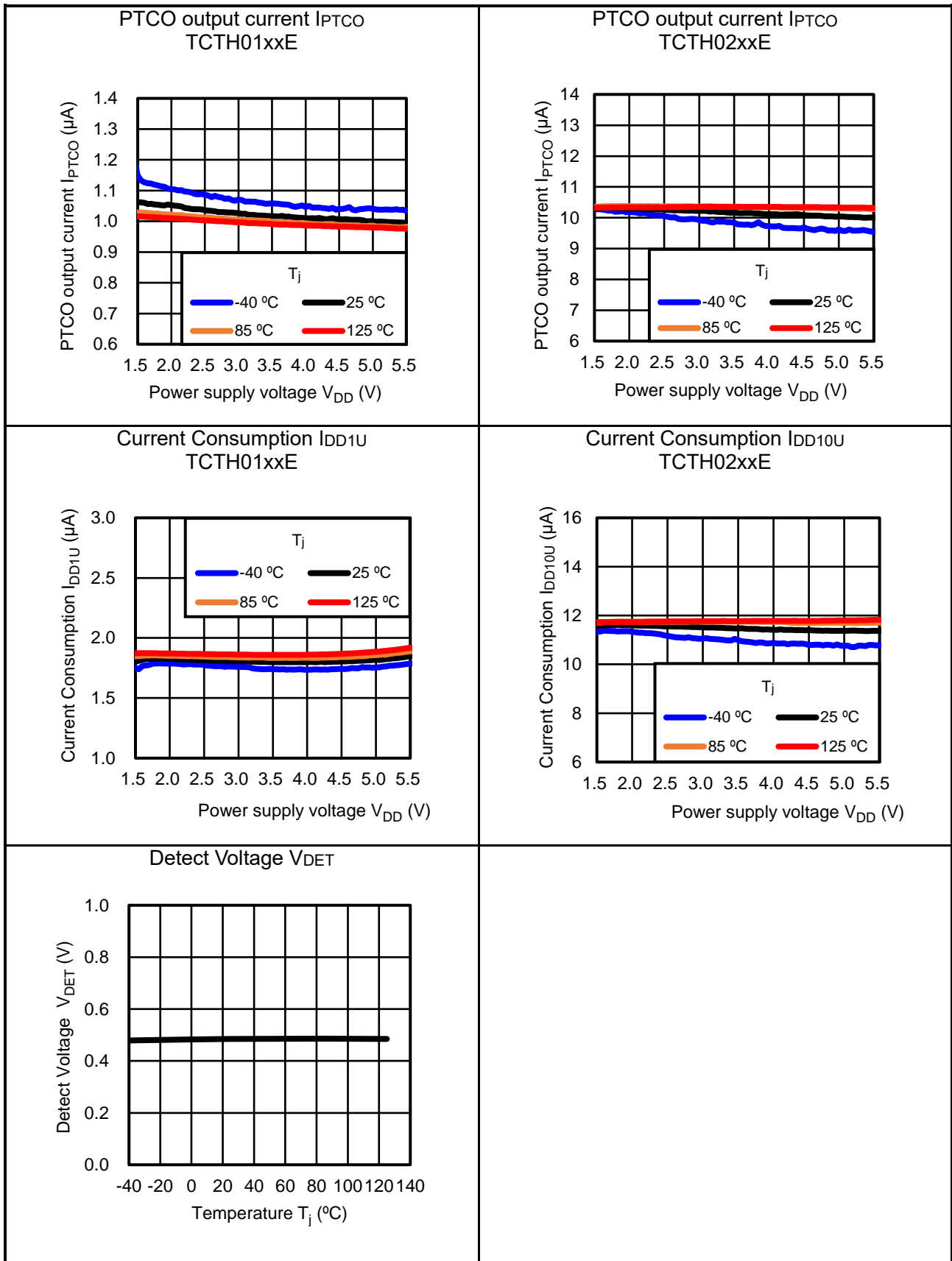

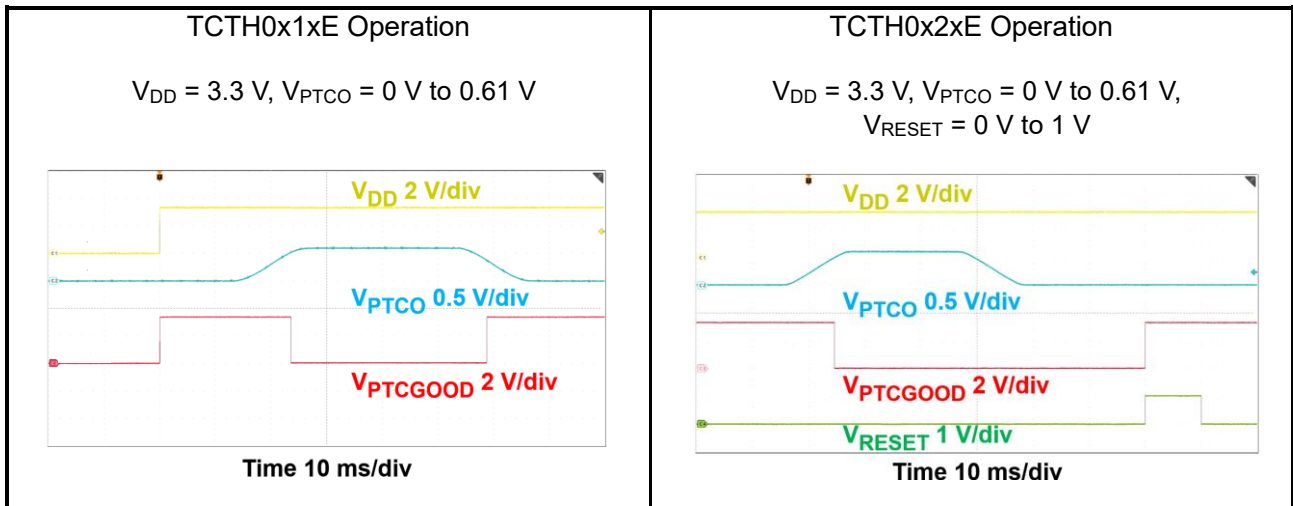

Note: The above characteristics curves are presented for reference only and not guaranteed by production test, unless otherwise noted.

12. Package Dimension

ESV(SOT-553)

Unit: mm

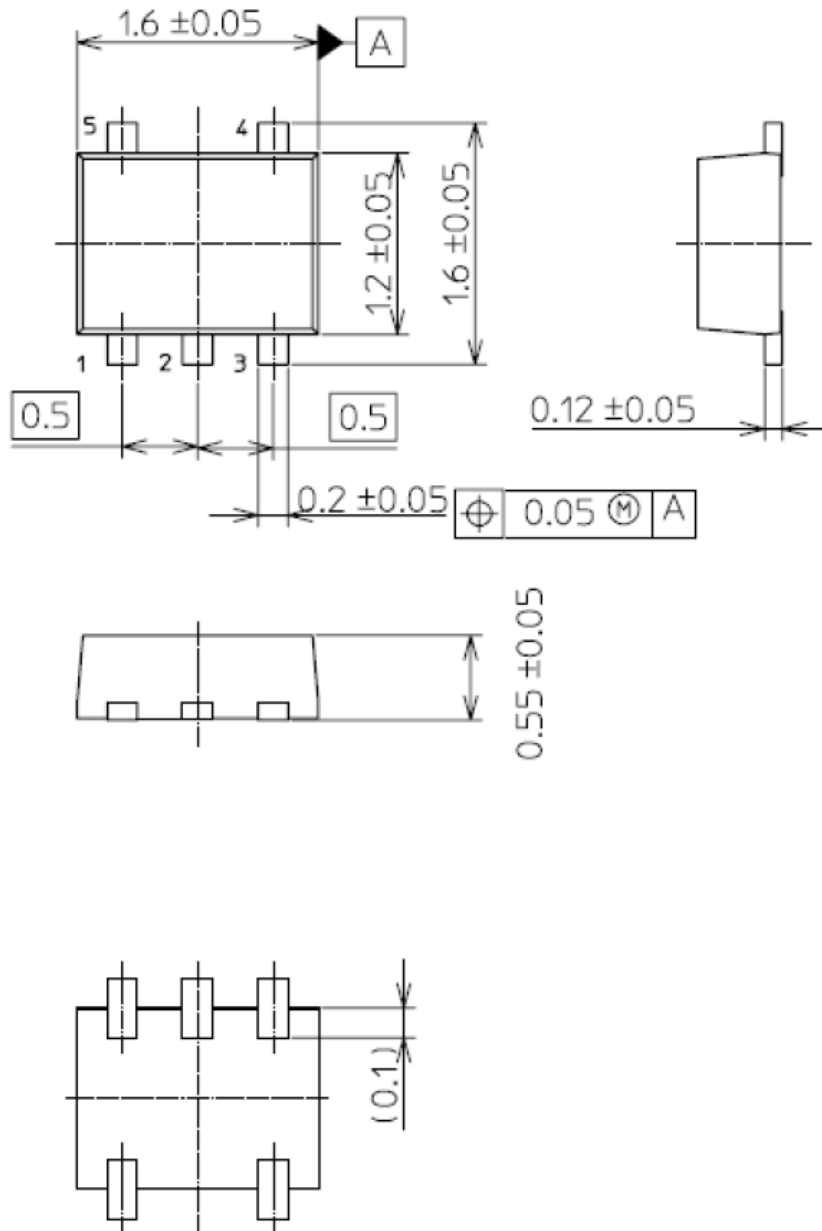

Weight: 2.98 mg (Typ.)

RESTRICTIONS ON PRODUCT USE

Toshiba Corporation and its subsidiaries and affiliates are collectively referred to as "TOSHIBA". Hardware, software and systems described in this document are collectively referred to as "Product".

- TOSHIBA reserves the right to make changes to the information in this document and related Product without notice.
- This document and any information herein may not be reproduced without prior written permission from TOSHIBA. Even with TOSHIBA's written permission, reproduction is permissible only if reproduction is without alteration/omission.
- Though TOSHIBA works continually to improve Product's quality and reliability, Product can malfunction or fail. Customers are responsible for complying with safety standards and for providing adequate designs and safeguards for their hardware, software and systems which minimize risk and avoid situations in which a malfunction or failure of Product could cause loss of human life, bodily injury or damage to property, including data loss or corruption. Before customers use the Product, create designs including the Product, or incorporate the Product into their own applications, customers must also refer to and comply with (a) the latest versions of all relevant TOSHIBA information, including without limitation, this document, the specifications, the data sheets and application notes for Product and the precautions and conditions set forth in the "TOSHIBA Semiconductor Reliability Handbook" and (b) the instructions for the application with which the Product will be used with or for. Customers are solely responsible for all aspects of their own product design or applications, including but not limited to (a) determining the appropriateness of the use of this Product in such design or applications; (b) evaluating and determining the applicability of any information contained in this document, or in charts, diagrams, programs, algorithms, sample application circuits, or any other referenced documents; and (c) validating all operating parameters for such designs and applications. **TOSHIBA ASSUMES NO LIABILITY FOR CUSTOMERS' PRODUCT DESIGN OR APPLICATIONS.**
- **PRODUCT IS NEITHER INTENDED NOR WARRANTED FOR USE IN EQUIPMENTS OR SYSTEMS THAT REQUIRE EXTRAORDINARILY HIGH LEVELS OF QUALITY AND/OR RELIABILITY, AND/OR A MALFUNCTION OR FAILURE OF WHICH MAY CAUSE LOSS OF HUMAN LIFE, BODILY INJURY, SERIOUS PROPERTY DAMAGE AND/OR SERIOUS PUBLIC IMPACT ("UNINTENDED USE").** Except for specific applications as expressly stated in this document, Unintended Use includes, without limitation, equipment used in nuclear facilities, equipment used in the aerospace industry, Class 3 medical devices, equipment used for automobiles, and military vehicles and munitions. **IF YOU USE PRODUCT FOR UNINTENDED USE, TOSHIBA ASSUMES NO LIABILITY FOR PRODUCT.** For details, please contact your TOSHIBA sales representative or contact us via our website.
- Do not disassemble, analyze, reverse-engineer, alter, modify, translate or copy Product, whether in whole or in part.
- Product shall not be used for or incorporated into any products or systems whose manufacture, use, or sale is prohibited under any applicable laws or regulations.
- The information contained herein is presented only as guidance for Product use. No responsibility is assumed by TOSHIBA for any infringement of patents or any other intellectual property rights of third parties that may result from the use of Product. No license to any intellectual property right is granted by this document, whether express or implied, by estoppel or otherwise.
- **ABSENT A WRITTEN SIGNED AGREEMENT, EXCEPT AS PROVIDED IN THE RELEVANT TERMS AND CONDITIONS OF SALE FOR PRODUCT, AND TO THE MAXIMUM EXTENT ALLOWABLE BY LAW, TOSHIBA (1) ASSUMES NO LIABILITY WHATSOEVER, INCLUDING WITHOUT LIMITATION, INDIRECT, CONSEQUENTIAL, SPECIAL, OR INCIDENTAL DAMAGES OR LOSS, INCLUDING WITHOUT LIMITATION, LOSS OF PROFITS, LOSS OF OPPORTUNITIES, BUSINESS INTERRUPTION AND LOSS OF DATA, AND (2) DISCLAIMS ANY AND ALL EXPRESS OR IMPLIED WARRANTIES AND CONDITIONS RELATED TO SALE, USE OF PRODUCT, OR INFORMATION, INCLUDING WARRANTIES OR CONDITIONS OF MERCHANTABILITY, FITNESS FOR A PARTICULAR PURPOSE, ACCURACY OF INFORMATION, OR NONINFRINGEMENT.**
- Do not use or otherwise make available Product or related software or technology for any military purposes, including without limitation, for the design, development, use, stockpiling or manufacturing of nuclear, chemical, or biological weapons or missile technology products (mass destruction weapons). Product and related software and technology may be controlled under the applicable export laws and regulations including, without limitation, the Japanese Foreign Exchange and Foreign Trade Law and the U.S. Export Administration Regulations. Export and re-export of Product or related software or technology are strictly prohibited except in compliance with all applicable export laws and regulations.
- Please contact your TOSHIBA sales representative for details as to environmental matters such as the RoHS compatibility of Product. Please use Product in compliance with all applicable laws and regulations that regulate the inclusion or use of controlled substances, including without limitation, the EU RoHS Directive. **TOSHIBA ASSUMES NO LIABILITY FOR DAMAGES OR LOSSES OCCURRING AS A RESULT OF NONCOMPLIANCE WITH APPLICABLE LAWS AND REGULATIONS.**