

Inverter Circuit for IH Cooker

Reference Guide

RD206-RGUIDE-01

TOSHIBA ELECTRONIC DEVICES & STORAGE CORPORATION

Contents

1. Introduction	3
2. Specification	3
2.1. Specification	3
2.2. Outline	5
2.2.1. Main Board	6
2.2.2. Control Board	8
2.3. Block Diagram	10
2.4. PCB Component Layout	11
2.5. PCB Pattern	12
3. Operating Procedure	13
3.1. External Connection	13
3.2. Start Procedure	13
3.3. Stop Procedure	13
3.4. Precautions for Evaluation (To Prevent Electric Shock, Burn Injury, etc.) 14	
4. Power Consumption	15
5. EMI radiation noise	16

1. Introduction

This reference guide describes the specifications, basic circuitry, and other features of the IH Cooker built using GT20N135SRA IGBT. Toshiba's IGBT (GT20N135SRA) and Holtek's MCU (HT45F0058) used in this application are designed specifically to be used with home appliance applications to provide most operational and economical efficiency. High-speed switching, High maximum junction temperature and Low saturation voltage are some key features of GT20N135SRA IGBT. The input-voltage range of this IH Cooker is from AC 200 V to 240 V at 50 Hz. This reference guide provides various design information including reference design, and contributes to the reduction of effort required in designing according to actual specifications.

2. Specification

2.1. Specification

Table 2.1 lists the general specification of this IH Cooker.

Table 2.1 General Specification

No.	Item	Overview	Remarks
1	Mode	Voltage resonance system	
2	Basic feature	IH Cooker with coil power control (function limited)	
3	Safety Standards	Designed for IEC60355-1 standard	
4	EMI standards	Designed for CISPR14 standard	
5	Input voltage	AC 200 V ~ AC 240 V Single phase (50 Hz typical)	
6	Cooling	Uses one DC 18 V Fan	
7	Main board	Performs the main operation of controlling IGBT and coil current.	
8	Control board	Takes user input and sends to the Main board.	
9	Precautions	The voltage equivalent to the input is applied to most of the inside of this product, and touching inside may result in an electric shock or burns, so do not touch.	

Table 2.2 lists the specifications of the main board of this IH Cooker.

Table 2.2 Main Board Specification

No.	Item	Overview	Remarks
1	Communication with the control board	I/O port control by I2C-bus(Master) software	
2	Debugging communication	I/O port control by UART software	TX only
3	Microcontroller	Part No.: HT45F0058 (Holtek)	
4	IGBT	Part No.: GT20N135SRA (Toshiba)	
5	Resonant capacitor	MKPH 0.24 μ F, 630 Vac (BM Cap) or equivalent	

6	IGBT TEMP SENSOR	For monitoring IGBT temperature Thermistor type: 100 k Ω , B25/75:3964K	
7	Main temperature sensor	For monitoring IH coil temperature Thermistor type	
8	18 V power supply (+18 V)	+18 V power supply for IGBT drive and fan	
9	5 V power supply (+5 V)	+5 V power supply for main board MCU and control board	
10	Coating of the substrate	No coating	

Table 2.3 lists the specifications of the control board of this IH Cooker.

Table 2.3 Control Board Specification

No.	Item	Overview	Remarks
1	Communicating with the Mainboard	Uses I2C-bus(Slave) H/W module	
2	Microcontroller	Part No.: BS86D12C (Holtek)	
3	Touch key	7 pcs. (Electrostatic Touch Sensor)	
4	LED	12 pcs. (1 pc. is spare)	
5	7-Seg LED	4 digits	
9	5 V power supply (+5 V)	Supplied from the main board	
10	Coating of the substrate	No coating	

2.2. Outline

Fig. 2.1 shows an overview of this IH Cooker components. External dimensions of IH Cooker are 350 mm x 280 mm x 60 mm.

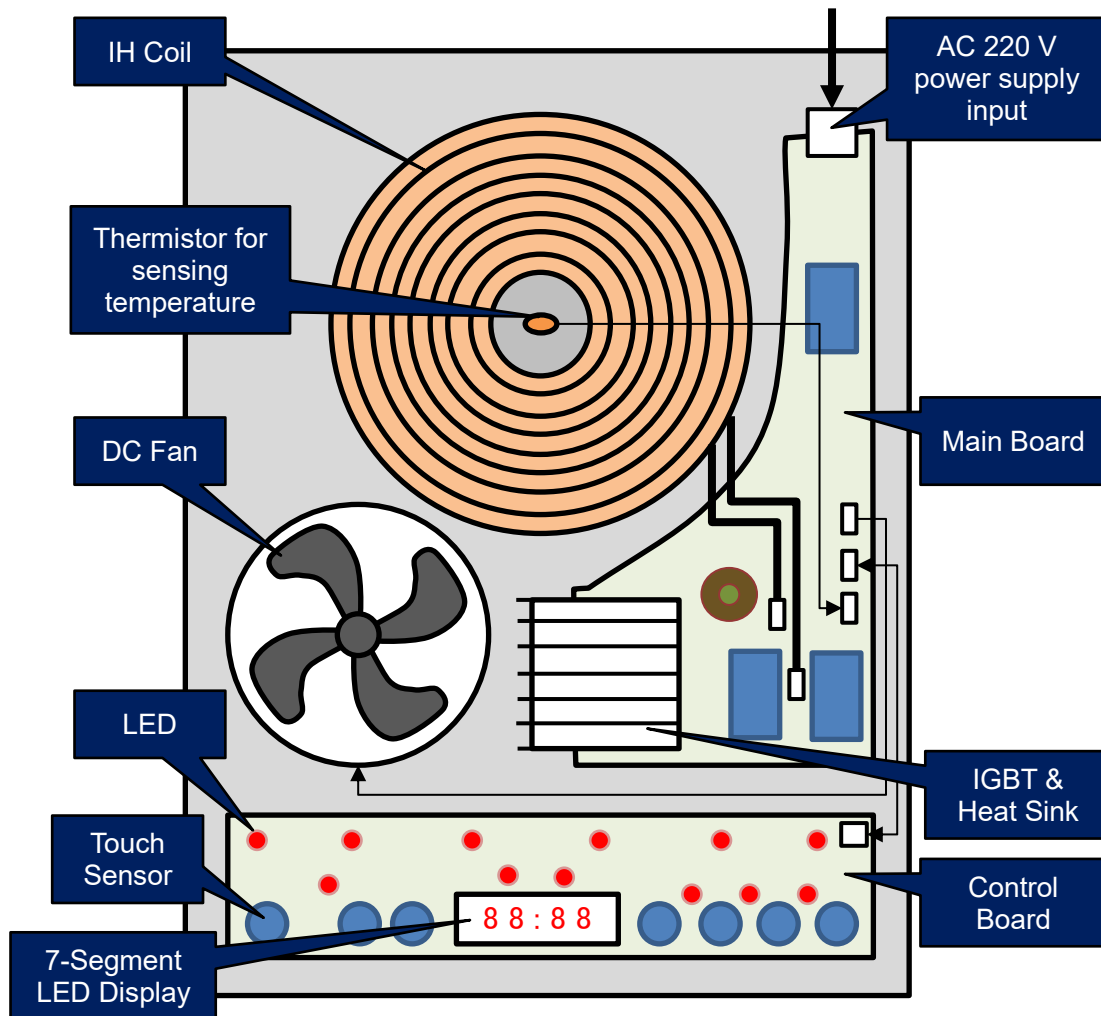

Fig. 2.1 Overall View of IH Cooker Components

2.2.1. Main Board

Fig. 2.2 shows the front side and back side of the main board.

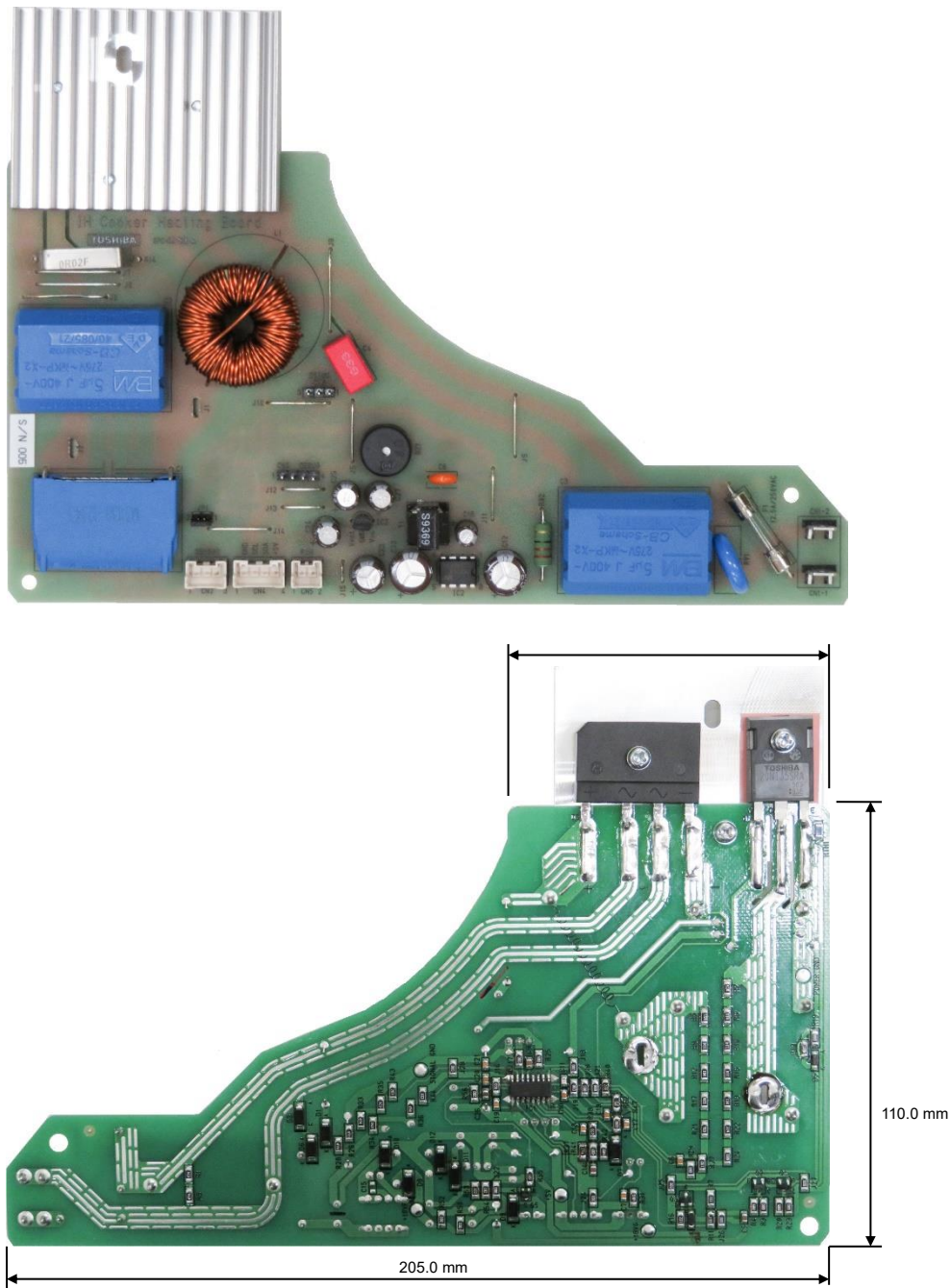

Fig. 2.2 Front Side and Back Side View of the Main Board

Board size	205 × 110 mm
Board type	CEM-3 (single side)

Fig. 2.3 shows the connectors on the main board.

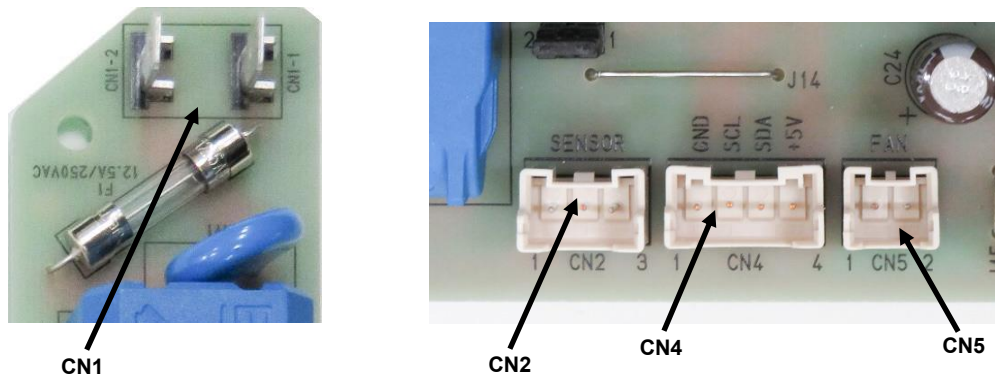

Fig. 2.3 Connectors on the Main Board

(1) CN1 for AC Power Supply Input

It is a Faston terminal.

Manufacturer: KEYSTONE

Part No.: 4902

Pin map:

Terminal No.	board	Signal name	Function
1		AC1	For Input AC
2		AC2	For Input AC

(2) J1 & J2 for IH Coil Connection

Direct soldering of wires is used for this connection.

Pin map:

Terminal No.	board	Signal name	Function
J1		OUT1	For IH coil connection
J2		OUT2	

(3) CN2 for NTC Thermistor Connection

Manufacturer name: JST

Part No.: B03B-XASK-1

Pin map:

Pin number	Signal name	Function
1	HTC	Main temperature sensor: Thermistor for temperature monitoring of IH coil (pot bottom).
2	-	
3	VDD	Thermistor power supply (+5 V)

(4) CN3 for Programming MCU

Manufacturer name: JST

Part No.: T4B-SQ(LF)(SN)

Pin map:

Pin number	Signal name	Function
1	GND	

2	OCSDSA	Programmer data
3	OCDSCK	Programmer clock
4	VDD	Power supply for the programmer (+5 V)

(5) CN4 for Control Board Connection

Manufacturer name: JST

Part No.: B04B-XASK-1

Pin map:

Pin number	Signal name	Function
1	GND	
2	SCL	I ² C-Bus SCL signals for communication with the control board
3	SDA	I ² C-Bus SDA signal for communication with the control board
4	VDD	Power supply for the control board (+5 V)

(6) CN5 for Fan Power Connection

Manufacturer name: JST

Part No.: B02B-XASK-1

Pin map:

Pin number	Signal name	Function
1	FAN	ON/OFF control by software
2	+18VF	Power supply for FAN (+18 V)

(6) CN6 for Debugging via Serial Out

Manufacturer name: JST

Part No.: T3B-SQ(LF)(SN)

Pin map:

Pin	Signal name	Description
1	VSS	
2	TXD	Serial output for debugging
3	VDD	Outputs +5 V

2.2.2. Control Board

Description of keys available for use in this IH Cooker reference design is as follows:

- Power Key: To turn on and off the power supply of IH Cooker.
- Pause Key: To temporarily stop the heating process.
- Strong Heat Key: To start "Strong Heat" mode of heating.
- + Key: To increase the heating power.
- - Key: To decrease the heating power.

Description of LEDs used in this IH Cooker reference design is as follows:

- "Power Supply LED" indicates the status of power supply.
- "Pause LED" indicates that the heating process is temporarily stopped.
- "Strong Heat LED" indicates that the "Strong Heat" mode is enabled.

(1) CN101 for Control Board Connection

Manufacturer name: JST

Part No.: S04B-XASK-1N-BN

Pin map:

Pin number	Signal name	Function
1	GND	
2	SCL	I ² C-Bus SCLsignals for communication with the control board
3	SDA	I ² C-Bus SDA-signal for communication with the control board
4	VDD	Power supply to the control board (+5 V)

(2) CN102 for programming MCU

Manufacturer name: JST

Part No.: T4B-SQ(LF)(SN)

Pin map:

Pin number	Signal name	Function
1	GND	
2	OCSDA	Programmer data
3	OCDSCK	Programmer clock
4	VDD	Power supply for the programmer (+5 V)

Error Indication

Following is the list of errors, which can be handled by this IH Cooker.

Error Code	Error Contents	Description
E0	No pot	No pot on the heating surface
E3	IGBT over temperature	IGBT overheat (110 °C or higher)
E4	IGBT NTC open/short circuit	IGBT temperature sensor failure
E5	Heating surface over temperature	Heating surface (IH coil) overheat (188 °C or higher)
E6	Heating surface NTC open/short circuit	Heating surface (IH coil) temperature sensor failure
E7	Mains overcurrent	AC-input overcurrent (rms 9.8 A or higher)
E8	Mains overvoltage (>=270 V)	AC input overvoltage (rms value 270 V or more)
E9	Mains undervoltage (<150 V)	AC input low voltage (effective value less than 150 V)

2.3. Block Diagram

Fig. 2.4 shows a block diagram of this IH Cooker. Refer to RD206-SCHEMATIC-01 for the actual schematic and to RD206-BOM-01 for the bill of materials.

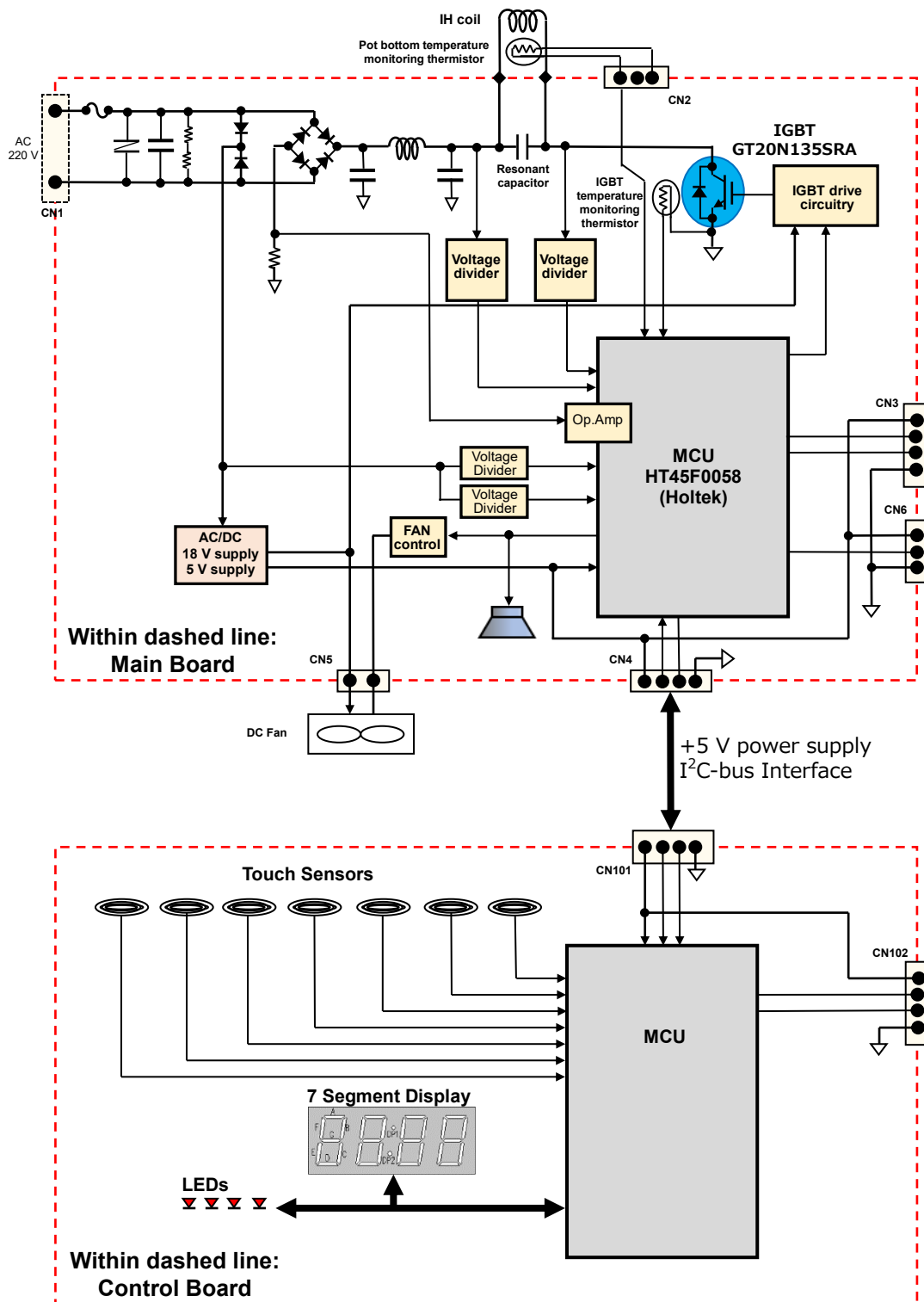

Fig. 2.4 Block Diagram

2.4. PCB Component Layout

Fig. 2.5 and Fig. 2.6 shows the layout of components on the main board PCB of this IH Cooker.

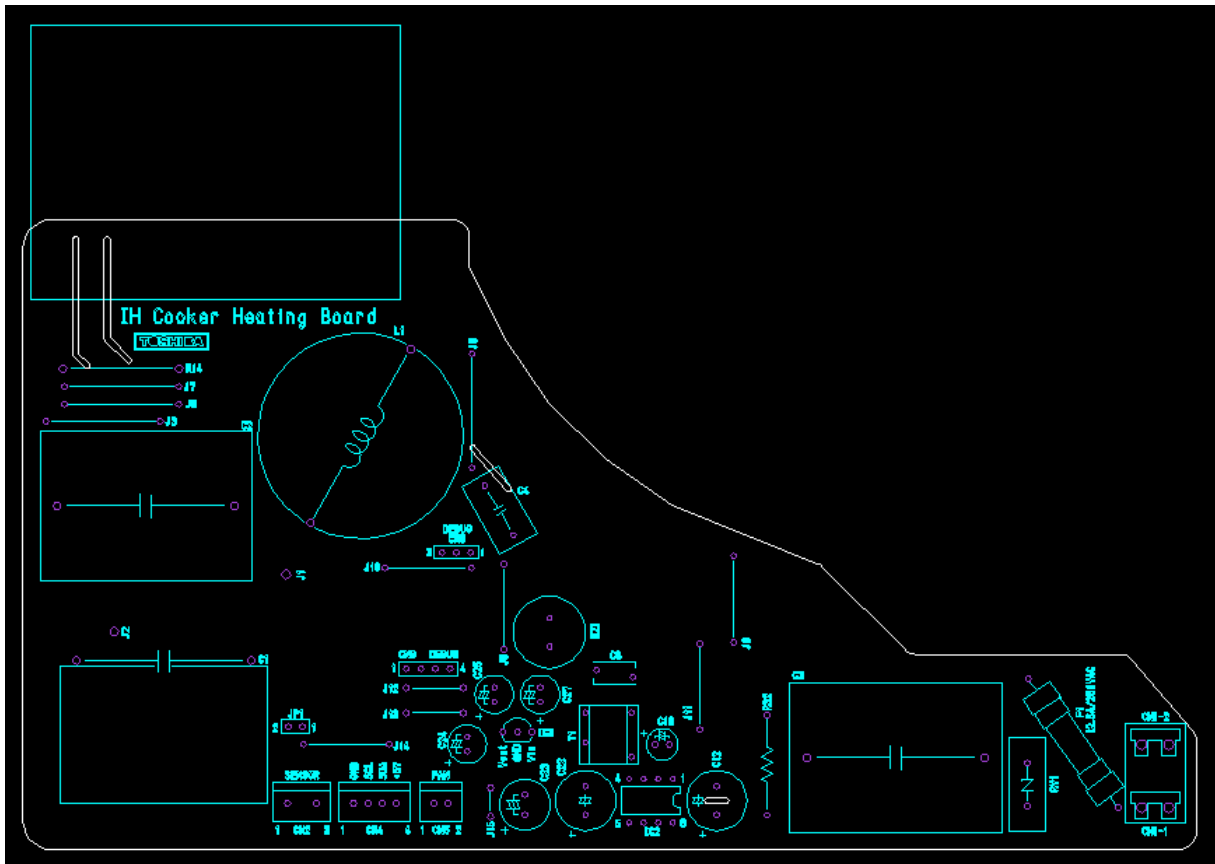

Fig. 2.5 Main Board PCB Component Layout (Front Side)

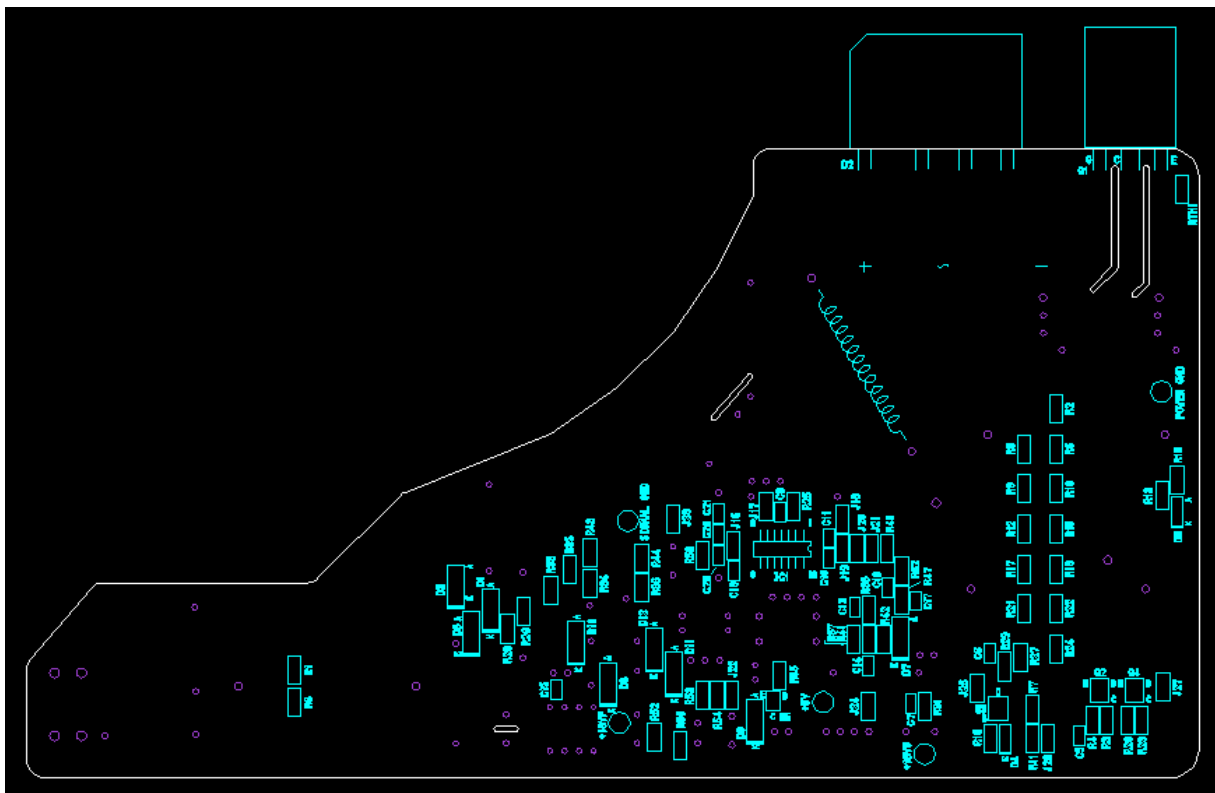

Fig. 2.6 Main Board PCB Component Layout (Back Side)

2.5. PCB Pattern

PCB design data of this IH Cooker is compatible with various EDA (Electronic Design Automation) tools. Please refer to webpage for more information.

Main Board PCB of this reference design is single sided. The Bottom Layer of the Main Board PCB is shown in Fig. 2.7.

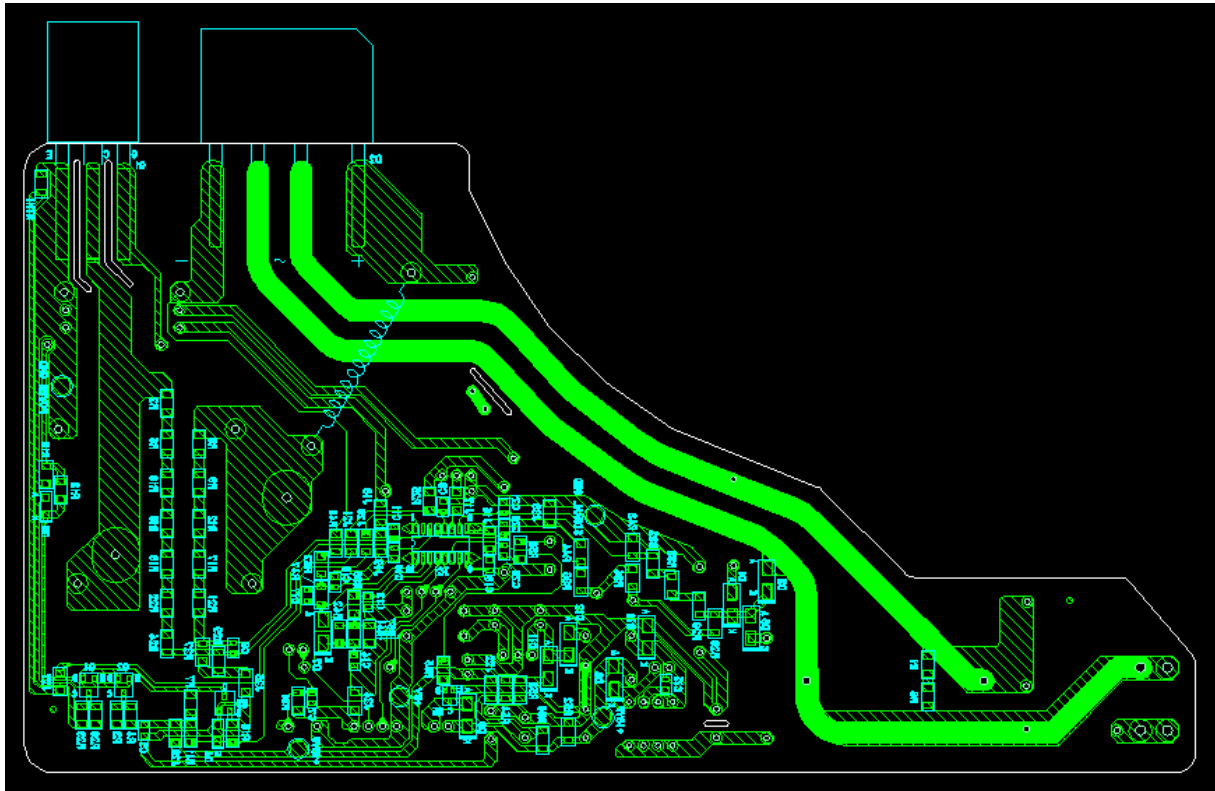

Fig. 2.7 Bottom Layer

3. Operating Procedure

This section describes the operating procedure of this IH Cooker.

3.1. External Connection

Connect the power cord of this IH Cooker to the AC 220 V power supply.

3.2. Start Procedure

- Connect IH Cooker to external AC power supply.
 - Buzzer sounds when AC power is supplied.
 - "Power LED" starts blinking.
- Touch the "Power Key" to turn on the IH Cooker.
 - "Power LED" turns on.
 - "-----" is displayed on 7-Seg LED Display.
- Touch the "Strong Heat Key" to turn on the heating.
 - "Strong Heat LED" turns on.
 - "2000" is displayed on the 7-Seg LED display. (Initial value is 2000 W).
- Touch "+ Key" or "- Key" to change the electric power setting.
 - Electric power can be set to 2000 W, 1800 W, 1600 W, 1400 W, 1200 W, 1000 W, 600 W, 300 W or 100 W.
 - 2000 W – 1000 W is continuous heating.
 - 600 W – 100 W is intermittent heating.

3.3. Stop Procedure

- Touch the "Power Key" while the power is on to turn off the IH Cooker.
 - Heating operation stops if it was in progress.
 - All LEDs except "Power LED" turns off and the "Power LED" starts blinking.

3.4. Precautions for Evaluation (To Prevent Electric Shock, Burn Injury, etc.)

Even after this IH Cooker is stopped, there is a risk of electric shock due to the residual charge present in various capacitors. Before touching the any component inside, check that the voltage of each component has decreased sufficiently.

In addition, semiconductors, coils, etc. of this IH Cooker generate heat according to the load current. Fig. 3.1 shows the components with high heat generation with red broken line frames. This IH Cooker uses a fan to provide air-cooling to ensure that the temperature of these components remain within the rated temperature range at high loads. Also, do not touch these components while the power supply is running, as there is a risk of burns.

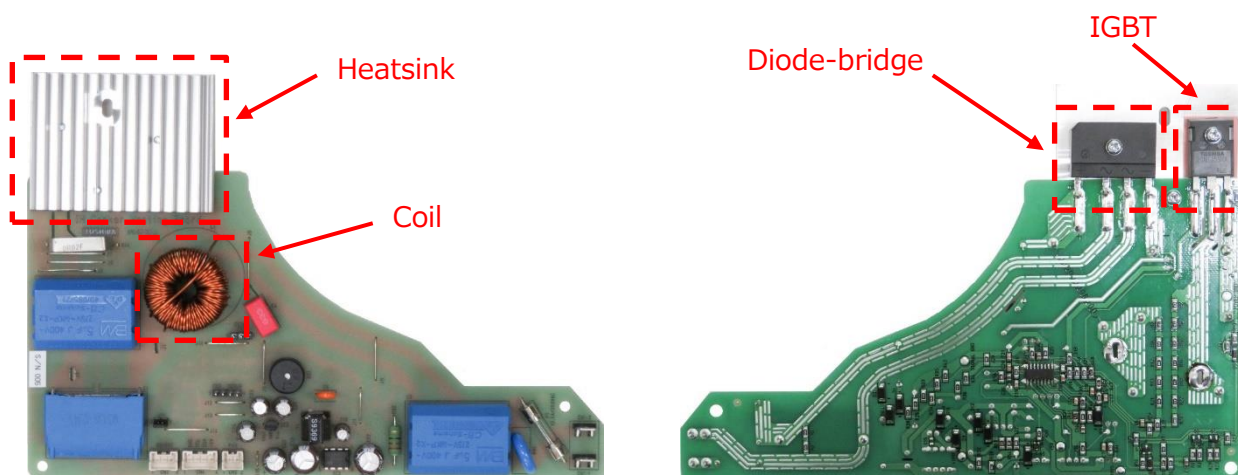

Fig. 3.1 Components with High Heat Generation

4. Power Consumption

The power consumption of this IH Cooker depends on the power supply voltage and the power setting.

The operation at 600 – 100 W is intermittent operation. The power measurement values for these are measured when heating is on.

The power consumption measurement data of this IH Cooker is shown in table below.

Table 4.1 Power Consumption Data

Input Voltage	Item On / Off	Power Setting (W)								
		100	300	600	1000	1200	1400	1600	1800	2000
220 V	Power Consumption (W)	1080	1080	1080	1080	1210	1416	1592	1795	2020
	Heating Pattern	2.5 s / 7.5 s	4 s / 6 s	7 s / 3 s	Always On	Always On	Always On	Always On	Always On	Always On
240 V	Power Consumption (W)	1076	1076	1076	1076	1182	1407	1586	1785	1945
	Heating Pattern	2.5 s / 7.5 s	4 s / 6 s	7 s / 3 s	Always On	Always On	Always On	Always On	Always On	Always On

■ : This property indicates the initial value.

Power consumption is a reference value and varies depending on the position of the pot and the operating environment.

5. EMI radiation noise

IH-cookers are generally required to comply with CISPR14-1 Ed 7.0 standard. Table 5.1 shows the margin values for the emission standard when this design is operated at a maximum output of 2 kW. In addition, the radiated emission standard margin for IGBT (Q1) equipped with our conventional product (GT40RR21) and equivalent products from other companies is also shown. Fig. 5.1 to 5.6 show reference measured radiation emission spectrum when each IGBT is mounted. GT20N135SRA is designed to reduce radiated emissions and has been found to comply with the emission standards specified in CISPR14-1 Ed 7.0 in Quasi-Peak of all frequency bands, even without any special EMI counter-measure implementation on the set-side.

Note: In CISPR14-1 Ed 7.0, radiated emissions from 30 MHz to 1 GHz are specified by the 10 m method, but this time we performed measurements using the 3 m method to clarify differences due to differences in the mounted elements. The standard value in the tables and figures uses the value obtained by distance conversion of the standard value of 10 m method.

Table 5.1 Radiation emission standard margins (Quasi-Peak) for this design

Frequency	Product used in this Design GT20N135SRA	TOSHIBA Conventional Product GT40RR21	Equivalent Product from Other Companies
Fundamental wave (23 kHz)	3.5 dB@ 23.080 kHz (Z-axis)	2.7 dB@ 23.120 kHz (Z-axis)	2.1 dB@ 22.986 kHz (Z-axis)
2nd(46 kHz)	14.7 dB@ 46.210 kHz (Z-axis)	14.8 dB@ 46.470 kHz (Z-axis)	14.6 dB@ 46.180 kHz (Z-axis)
3rd(69 kHz)	31.6 dB@ 69.280 kHz (Z-axis)	29.4 dB@ 69.740 kHz (Z-axis)	30.1 dB@ 69.300 kHz (Z-axis)
4th(92 kHz)	27.1 dB@ 92.390 kHz (Z-axis)	25.8 dB@ 93.030 kHz (Z-axis)	26.8 dB@ 92.410 kHz (Z-axis)
5th(116 kHz)	22.1 dB@ 115.600 kHz (Z-axis)	20.6 dB@ 116.400 kHz (Z-axis)	21.8 dB@ 115.700 kHz (Z-axis)
6th(139 kHz)	20.8 dB@ 38.900 kHz (Z-axis)	19.6 dB@ 139.560 kHz (Z-axis)	20.6 dB@ 138.900 kHz (Z-axis)
Between harmonics (158 kHz)	9.5 dB@ 158.210 kHz (Z-axis)	99 dB @ 157.800 kHz (Z-axis)	9.1 dB@ 159.300 kHz (Z-axis)
Between harmonics (1.29 MHz)	25.3 dB@ 1.287 MHz (Z-axis)	26.2 dB@ 1.298 MHz (X-axis)	26.0 dB@ 1.288 MHz (Z-axis)
30 MHz	8.2 dB@ 30.044 MHz (vertical)	-1.3 dB@ 30.040 MHz (vertical)	-1.0 dB@ 30.250 MHz (vertical)
40 MHz	11.6 dB@ 40.543 MHz (vertical)	2.2 dB@ 40.570 MHz (vertical)	4.9 dB@ 40.080 MHz (vertical)
99 MHz	14.6 dB@ 99.643 MHz (vertical)	11.7 dB@ 98.890 MHz (vertical)	11.2 dB@ 99.447 MHz (horizontal)
115 MHz	13.3 dB@ 115.587 MHz (horizontal)	9.0 dB@ 115.587 MHz (horizontal)	10.4 dB@ 115.560 MHz (horizontal)
192 MHz	8.7 dB@ 193.685 MHz (horizontal)	9.0 dB@ 191.431 MHz (horizontal)	8.3 dB@ 191.684 MHz (horizontal)

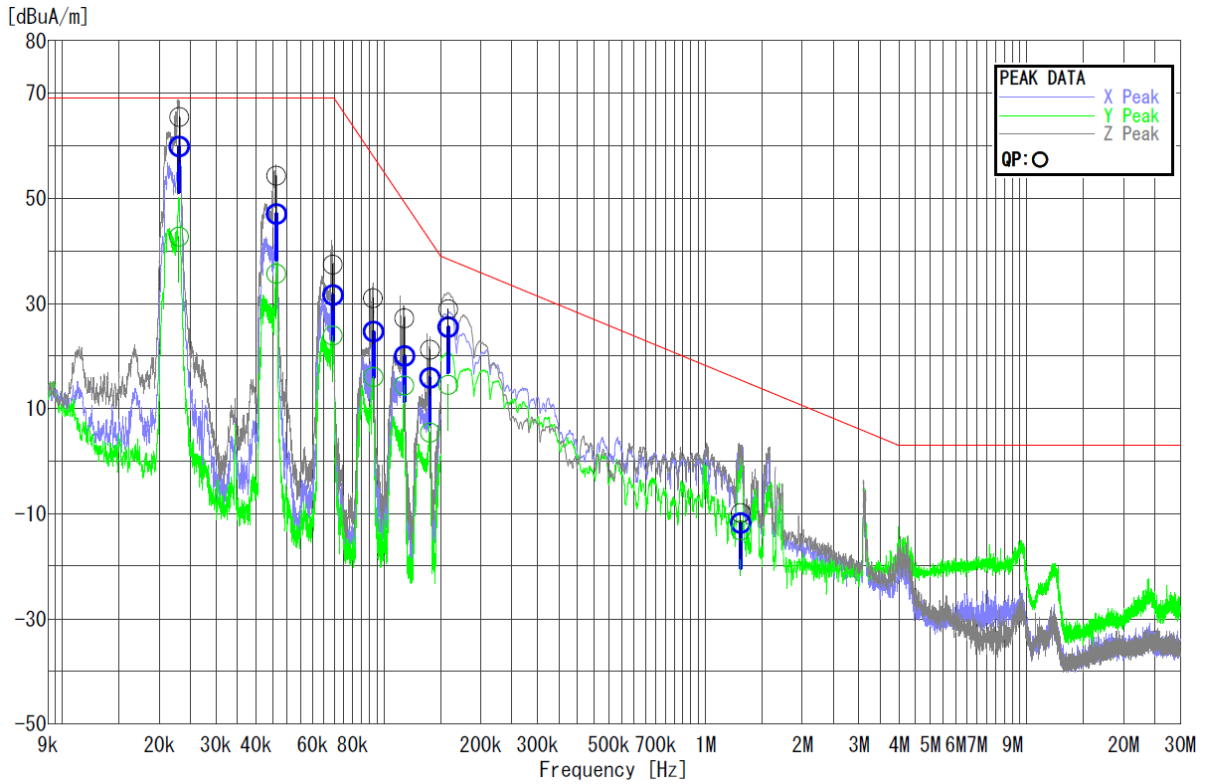

Fig. 5.1 Example of Radiation Emission Spectrum when Equipped with the Product (GT20N135SRA) used in this Design (30 MHz or Lower)

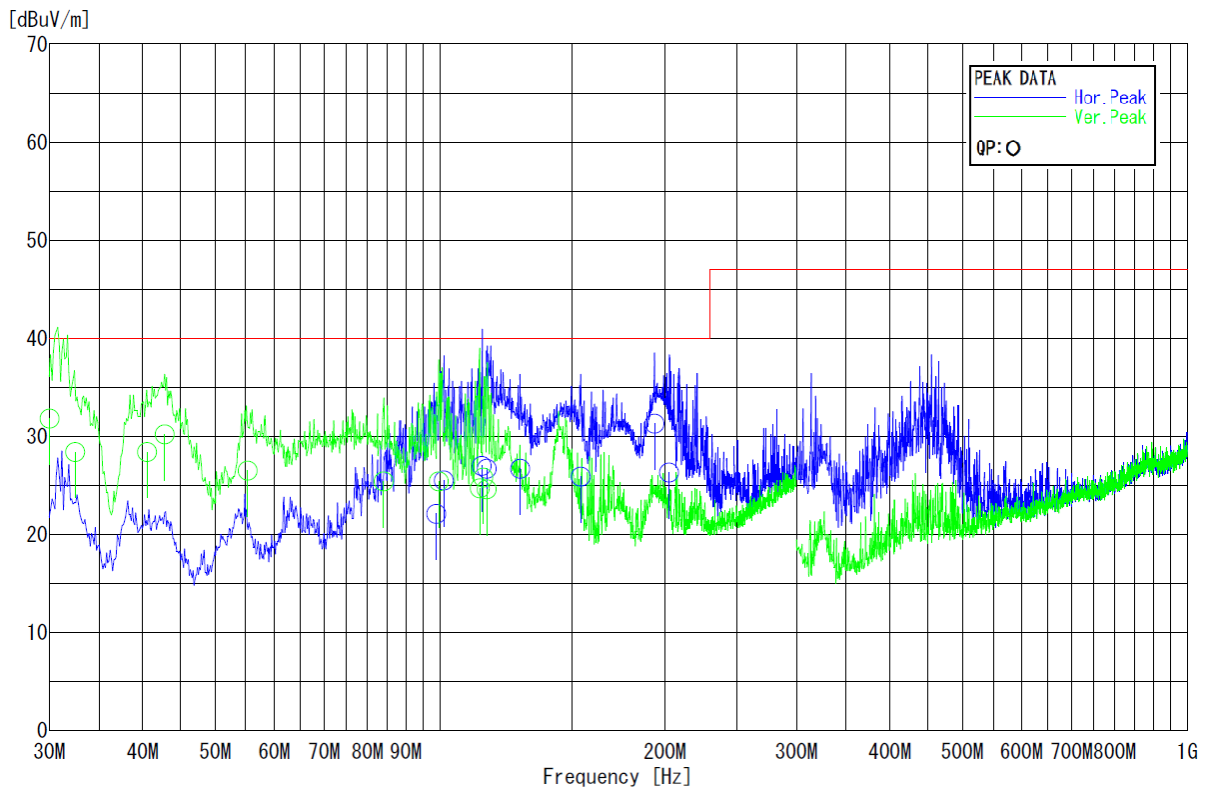

Fig. 5.2 Example of Radiation Emission Spectrum when Equipped with the Product (GT20N135SRA) used in this Design (30 MHz or Higher)

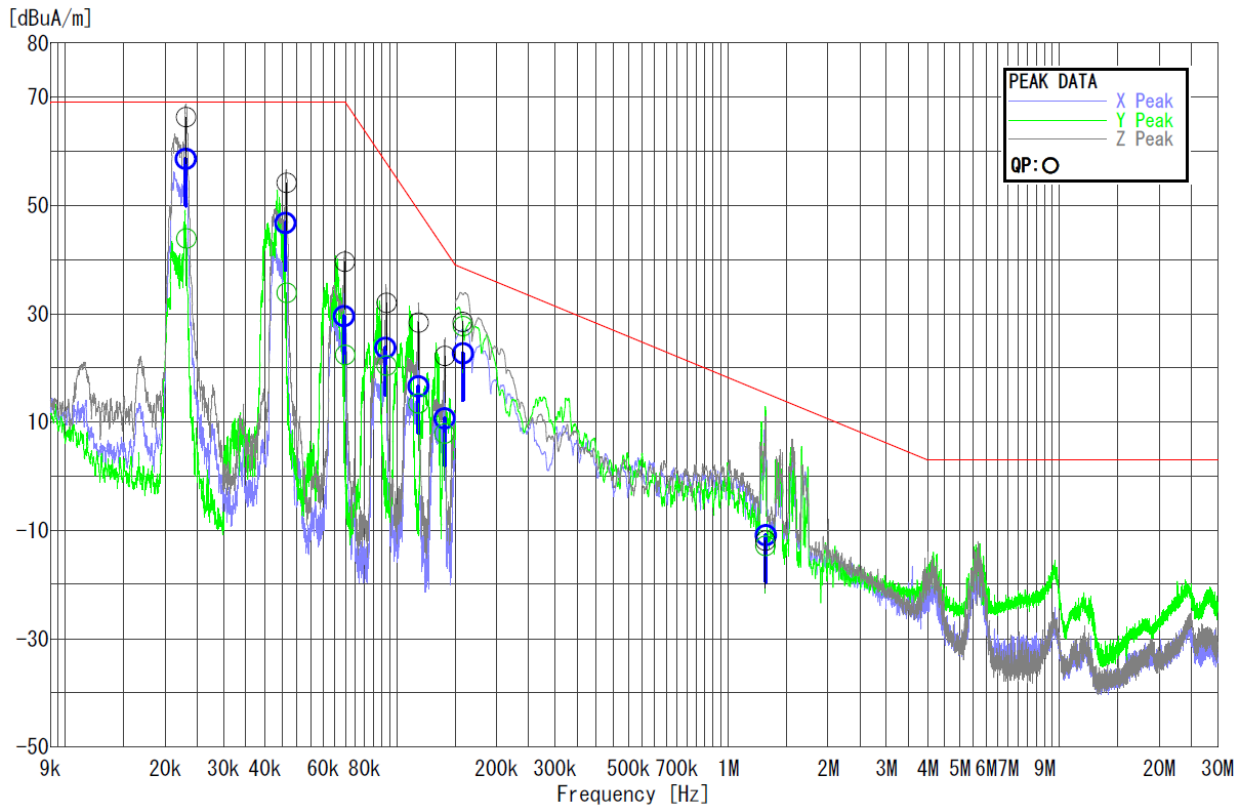

Fig. 5.3 Example of Radiation Emission Spectrum when Equipped with Toshiba's Conventional Product (GT40RR21) (30 MHz or Lower)

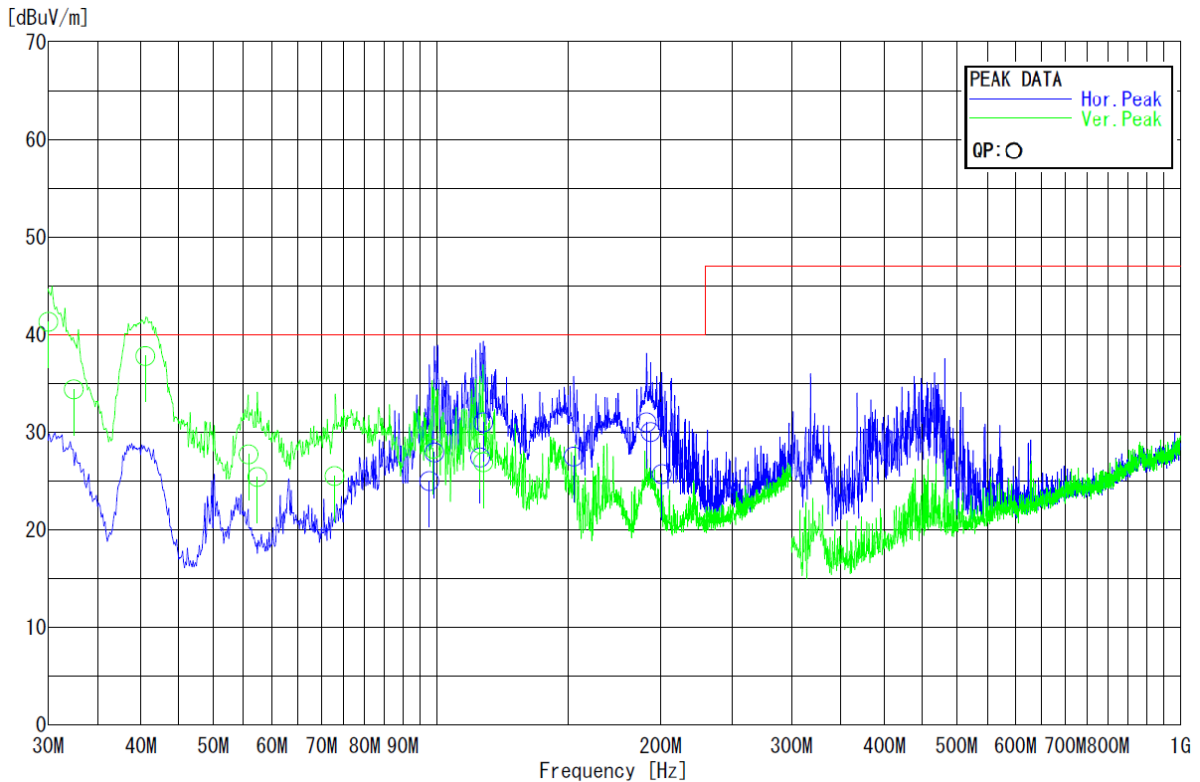

Fig. 5.4 Example of Radiation Emission Spectrum when Equipped with Toshiba's Conventional Product (GT40RR21) (30 MHz or Higher)

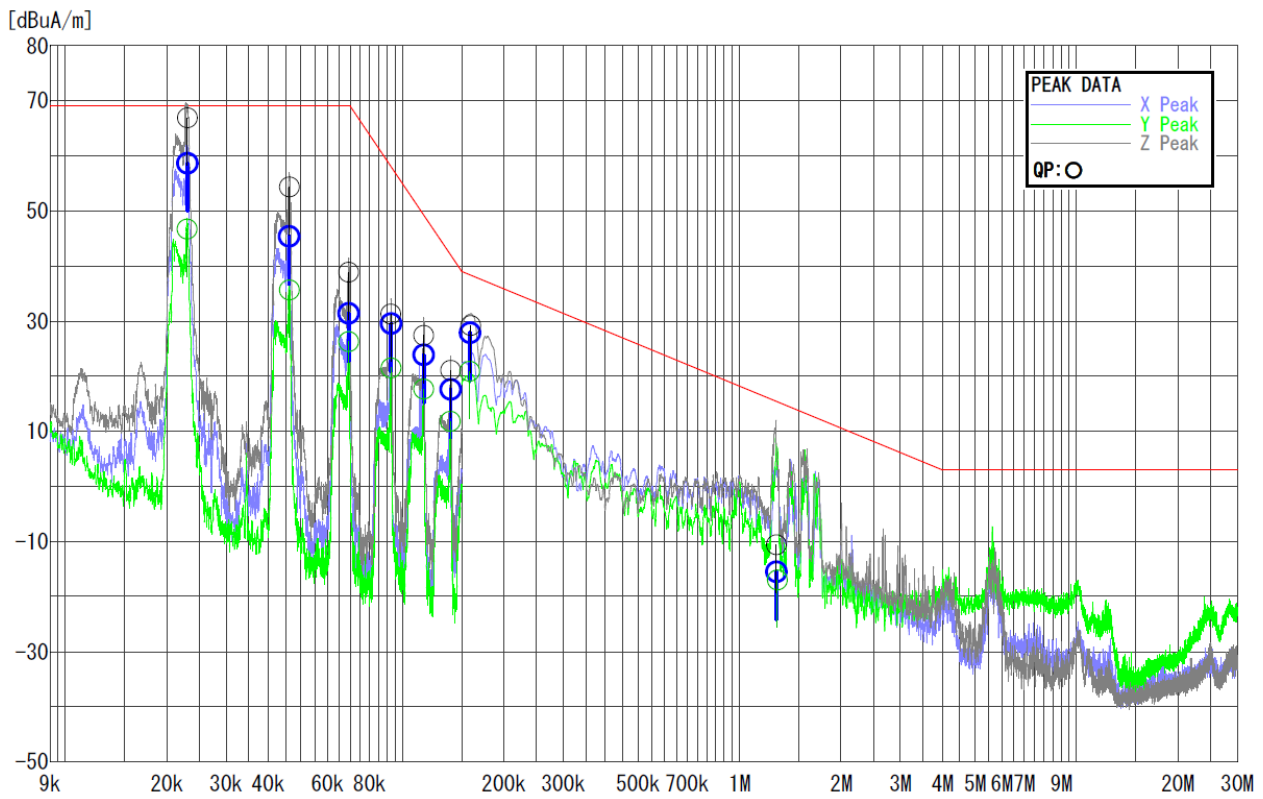

Fig. 5.5 Example of Radiation Emission Spectrum when Equipped with an Equivalent Product from Other Manufacturers (30 MHz or Lower)

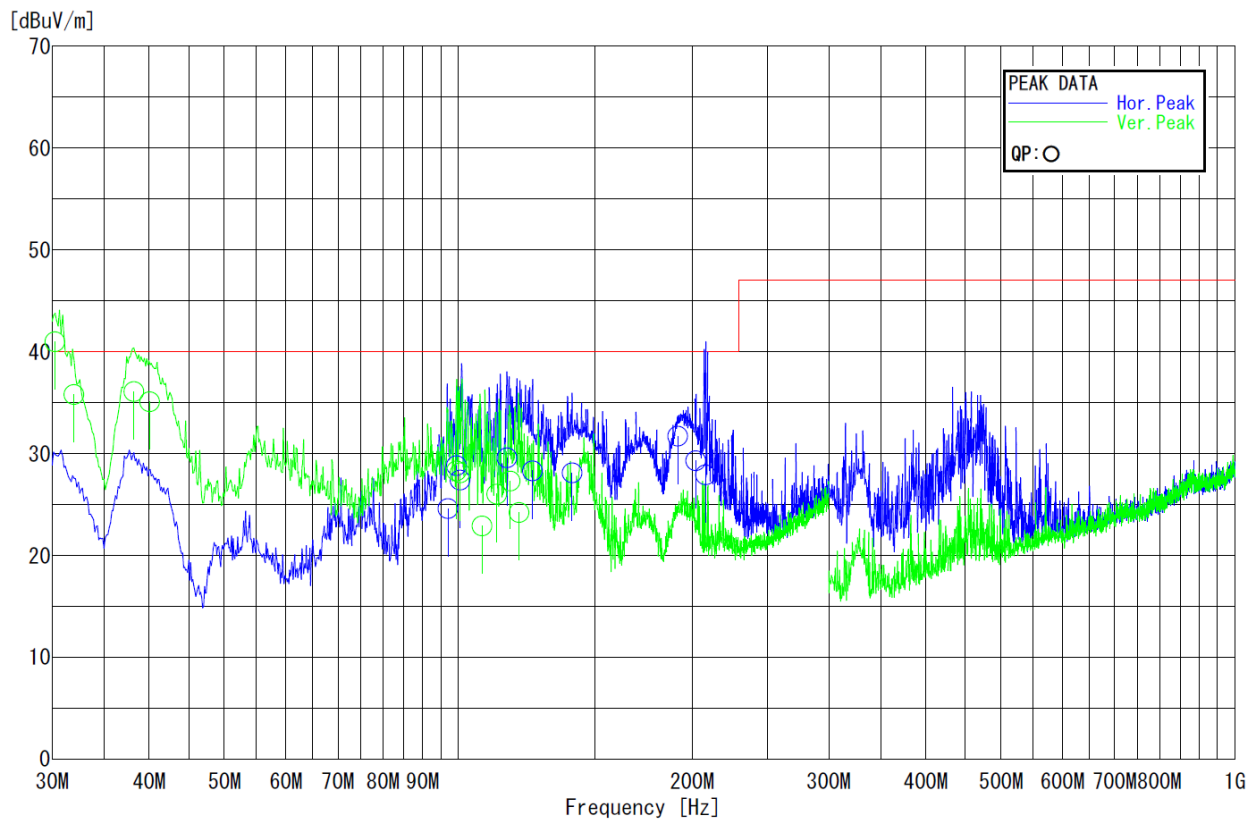

Fig. 5.6 Example of Radiation Emission Spectrum when Equipped with an Equivalent Product from Other Manufacturers (30 MHz or Higher)

Terms of Use

This terms of use is made between Toshiba Electronic Devices and Storage Corporation (“We”) and customers who use documents and data that are consulted to design electronics applications on which our semiconductor devices are mounted (“this Reference Design”). Customers shall comply with this terms of use. Please note that it is assumed that customers agree to any and all this terms of use if customers download this Reference Design. We may, at its sole and exclusive discretion, change, alter, modify, add, and/or remove any part of this terms of use at any time without any prior notice. We may terminate this terms of use at any time and for any reason. Upon termination of this terms of use, customers shall destroy this Reference Design. In the event of any breach thereof by customers, customers shall destroy this Reference Design, and furnish us a written confirmation to prove such destruction.

1. Restrictions on usage

1. This Reference Design is provided solely as reference data for designing electronics applications. Customers shall not use this Reference Design for any other purpose, including without limitation, verification of reliability.
2. This Reference Design is for customer's own use and not for sale, lease or other transfer.
3. Customers shall not use this Reference Design for evaluation in high or low temperature, high humidity, or high electromagnetic environments.
4. This Reference Design shall not be used for or incorporated into any products or systems whose manufacture, use, or sale is prohibited under any applicable laws or regulations.

2. Limitations

1. We reserve the right to make changes to this Reference Design without notice.
2. This Reference Design should be treated as a reference only. We are not responsible for any incorrect or incomplete data and information.
3. Semiconductor devices can malfunction or fail. When designing electronics applications by referring to this Reference Design, customers are responsible for complying with safety standards and for providing adequate designs and safeguards for their hardware, software and systems which minimize risk and avoid situations in which a malfunction or failure of semiconductor devices could cause loss of human life, bodily injury or damage to property, including data loss or corruption. Customers must also refer to and comply with the latest versions of all relevant our information, including without limitation, specifications, data sheets and application notes for semiconductor devices, as well as the precautions and conditions set forth in the "Semiconductor Reliability Handbook".
4. When designing electronics applications by referring to this Reference Design, customers must evaluate the whole system adequately. Customers are solely responsible for all aspects of their own product design or applications. WE ASSUME NO LIABILITY FOR CUSTOMERS' PRODUCT DESIGN OR APPLICATIONS.
5. No responsibility is assumed by us for any infringement of patents or any other intellectual property rights of third parties that may result from the use of this Reference Design. No license to any intellectual property right is granted by this terms of use, whether express or implied, by estoppel or otherwise.
6. THIS REFERENCE DESIGN IS PROVIDED "AS IS". WE (a) ASSUME NO LIABILITY WHATSOEVER, INCLUDING WITHOUT LIMITATION, INDIRECT, CONSEQUENTIAL, SPECIAL, OR INCIDENTAL DAMAGES OR LOSS, INCLUDING WITHOUT LIMITATION, LOSS OF PROFITS, LOSS OF OPPORTUNITIES, BUSINESS INTERRUPTION AND LOSS OF DATA, AND (b) DISCLAIM ANY AND ALL EXPRESS OR IMPLIED WARRANTIES AND CONDITIONS RELATED TO THIS REFERENCE DESIGN, INCLUDING WARRANTIES OR CONDITIONS OF MERCHANTABILITY, FITNESS FOR A PARTICULAR PURPOSE, ACCURACY OF INFORMATION, OR NONINFRINGEMENT.

3. Export Control

Customers shall not use or otherwise make available this Reference Design for any military purposes, including without limitation, for the design, development, use, stockpiling or manufacturing of nuclear, chemical, or biological weapons or missile technology products (mass destruction weapons). This Reference Design may be controlled under the applicable export laws and regulations including, without limitation, the Japanese Foreign Exchange and Foreign Trade Law and the U.S. Export Administration Regulations. Export and re-export of this Reference Design are strictly prohibited except in compliance with all applicable export laws and regulations.

4. Governing Laws

This terms of use shall be governed and construed by laws of Japan.