

TOSHIBA CMOS Linear Integrated Circuit Silicon Monolithic

TCR3LM series

Low quiescent current, 300 mA CMOS Low Dropout Regulator in ultra small package

1. Description

The TCR3LM series are CMOS general-purpose single-output voltage regulators with an on/off control input, featuring low quiescent current.

These voltage regulators are available in fixed output voltages between 0.8 V and 5.0 V and capable of driving up to 300 mA. They feature Overcurrent protection, Thermal shutdown and Auto-discharge.

The TCR3LM series is offered in the ultra small plastic mold package DFN4D (1.0 mm x 1.0 mm; t 0.37 mm (typ.)) and has low quiescent current ($I_B = 1.2 \mu\text{A}$ (typ.) at $I_{OUT} = 0 \text{ mA}$). As small ceramic input and output capacitors $0.47 \mu\text{F}$ can be used with the TCR3LM series, these devices are ideal for portable applications that require high-density board assembly such as cellular phones.

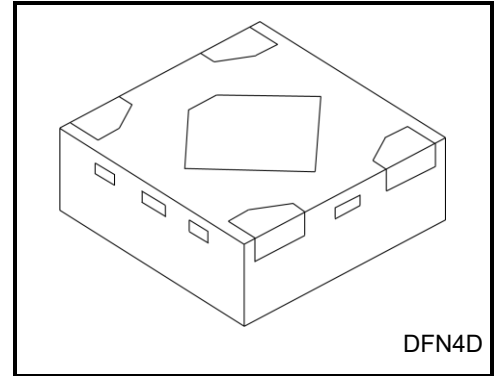

Weight: 1.1 mg (typ.)

2. Applications

Power IC developed for portable applications

3. Features

- Ultra small package DFN4D (1.0 mm x 1.0 mm; t 0.37 mm (typ.)).
- Low quiescent current ($I_{B(ON)} = 1.2 \mu\text{A}$ (typ.) at $I_{OUT} = 0 \text{ mA}$)
- High Ripple rejection ratio (74 dB (typ.) at 100 Hz, 0.8 V-output)
- Fast load transient response (-70/+35 mV at 2.8 V-output, $I_{OUT} = 1 \text{ mA} \leftrightarrow 100 \text{ mA}$)
- Low Dropout voltage ($V_{DO} = 213 \text{ mV}$ (typ.) at 2.8 V-output, $I_{OUT} = 200 \text{ mA}$)
- Wide range output voltage line up ($V_{OUT} = 0.8 \text{ to } 5.0 \text{ V}$)
- Overcurrent protection
- Thermal shutdown
- Auto-discharge
- Pull down connection between CONTROL and GND
- Ceramic capacitors can be used ($C_{IN} = 0.47 \mu\text{F}$, $C_{OUT} = 0.47 \mu\text{F}$)

Start of commercial production
2023-03

4. Absolute Maximum Ratings (Note) (Ta = 25°C)

Characteristics	Symbol	Rating	Unit
Input voltage	V _{IN}	-0.3 to 6.0	V
Control voltage	V _{CT}	-0.3 to V _{IN} + 0.3 ≤ 6.0	V
Output voltage	V _{OUT}	-0.3 to V _{IN} + 0.3 ≤ 6.0	V
Power dissipation	P _D	420 (Note 1)	mW
Junction temperature	T _j	150	°C
Storage temperature range	T _{stg}	-55 to 150	°C

Note: Using continuously under heavy loads (e.g. the application of high temperature/current/voltage and the significant change in temperature, etc.) may cause this product to decrease in the reliability significantly even if the operating conditions (i.e. operating temperature/current/voltage, etc.) are within the absolute maximum ratings and the operating ranges.

Please design the appropriate reliability upon reviewing the Toshiba Semiconductor Reliability Handbook (“Handling Precautions”/“Derating Concept and Methods”) and individual reliability data (i.e. reliability test report and estimated failure rate, etc).

Note 1: Rating at mounting on a board

Glass epoxy(FR4) board dimension: 40 mm x 40 mm x 1.6 mm, both sides of board.

Metal pattern ratio: a surface approximately 50%, the reverse side approximately 50%

Through hole: diameter 0.5 mm x 24 pcs

5. Pin Assignment (top view)

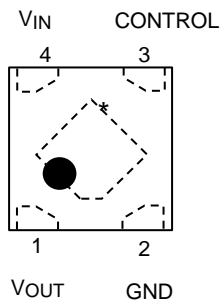

*Center electrode should be connected to GND or Open

6. Operating Ranges

Characteristics	Symbol	Rating	Unit
Input voltage	V _{IN}	1.4 to 5.5 (Note 2)	V
Control voltage	V _{CT}	0 to V _{IN}	V
Output voltage	V _{OUT}	0.8 to 5.0	V
Output current	I _{OUT}	DC 300	mA
Operation Temperature	T _{opr}	-40 to 85	°C
Output Capacitance	C _{OUT}	≥ 0.47	μF
Input Capacitance	C _{IN}	≥ 0.47	μF

Note 2: Please refer to Dropout Voltage Characteristics and use it within Absolute Maximum Ratings Junction temperature and Operation Temperature Ranges.

7. List of Products Number, Output voltage and Marking

Product No.	Output voltage (V)	Marking
TCR3LM08A	0.8	0K8
TCR3LM085A*	0.85	0KC
TCR3LM09A*	0.9	0K9
TCR3LM095A	0.95	0KD
TCR3LM10A*	1.0	1K0
TCR3LM105A*	1.05	1KE
TCR3LM11A*	1.1	1K1
TCR3LM115A*	1.15	1KF
TCR3LM12A	1.2	1K2
TCR3LM13A*	1.3	1K3
TCR3LM15A*	1.5	1K5
TCR3LM16A*	1.6	1K6
TCR3LM17A	1.7	1K7
TCR3LM18A	1.8	1K8
TCR3LM185A*	1.85	1KH
TCR3LM19A*	1.9	1K9
TCR3LM195A	1.95	1KK
TCR3LM20A*	2.0	2K0
TCR3LM25A	2.5	2K5
TCR3LM26A*	2.6	2K6
TCR3LM27A*	2.7	2K7
TCR3LM28A	2.8	2K8
TCR3LM285A*	2.85	2KJ
TCR3LM29A*	2.9	2K9
TCR3LM30A*	3.0	3K0
TCR3LM31A*	3.1	3K1
TCR3LM32A*	3.2	3K2
TCR3LM33A	3.3	3K3
TCR3LM35A*	3.5	3K5
TCR3LM36A*	3.6	3K6
TCR3LM42A*	4.2	4K2
TCR3LM45A*	4.5	4K5
TCR3LM50A*	5.0	5K0

* Please contact your local Toshiba representative if you are interested in products with * sign.

Top Marking (top view)

Example: TCR3LM25A (2.5 V output)

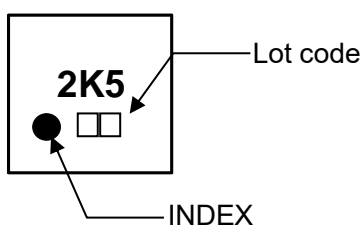

8. Block Diagram

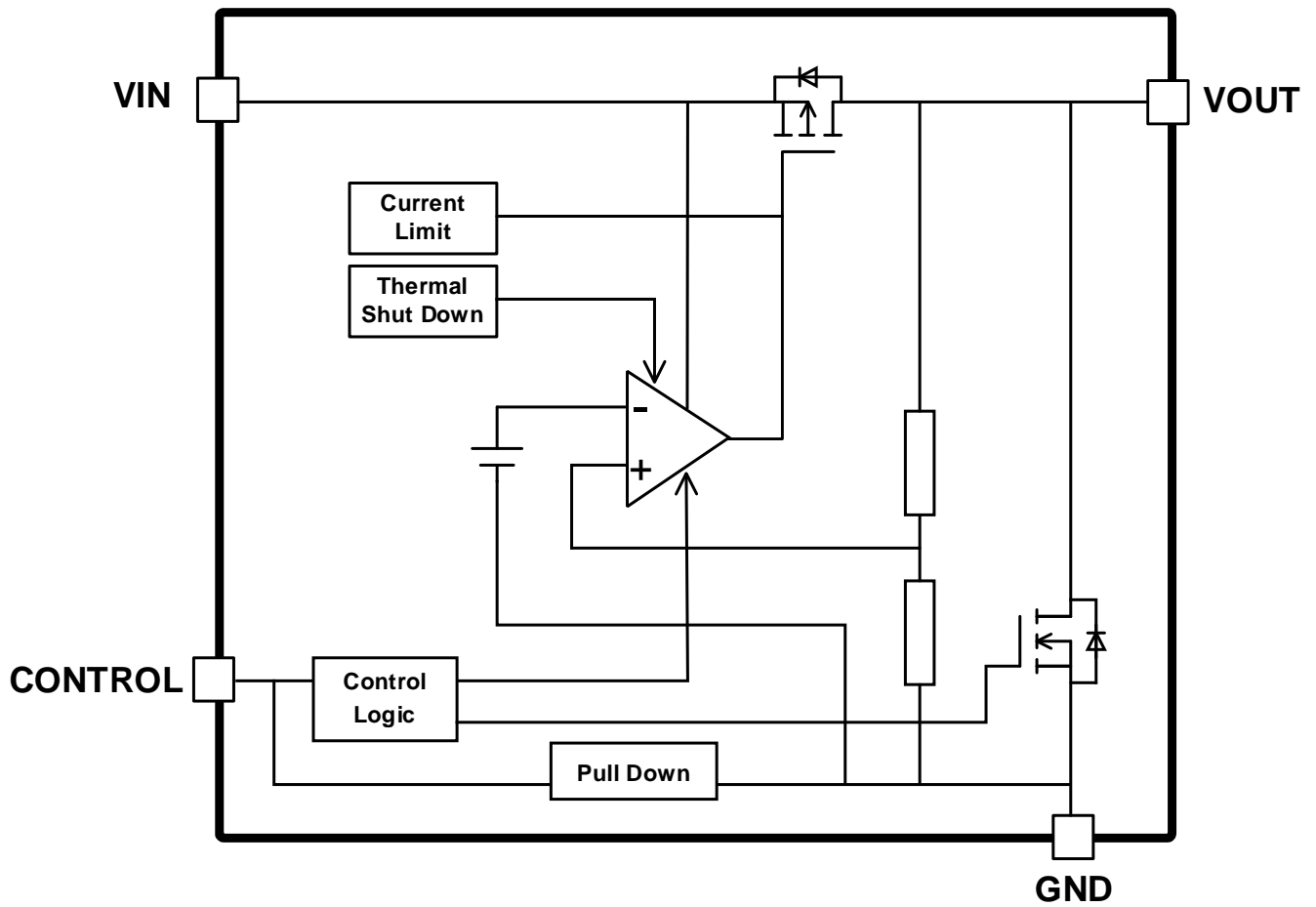

9. Electrical Characteristics

(Unless otherwise specified, $V_{IN} = 2.5\text{ V}$ or $V_{OUT} + 1.0\text{ V}$ (whichever is greater), $V_{IN} = 5.5\text{ V}$ ($V_{OUT} = 5.0\text{ V}$), $C_{IN} = C_{OUT} = 0.47\text{ }\mu\text{F}$)

Characteristics	Symbol	Test Condition	$T_j = 25^\circ\text{C}$			$T_j = -40\text{ to }85^\circ\text{C}$ (Note 8)		Unit	
			Min	Typ.	Max	Min	Max		
Output voltage accuracy	V_{OUT}	$I_{OUT} = 50\text{ mA}$ $V_{IN} = V_{OUT} + 1\text{ V}$ (Note 3)	$V_{OUT} < 1.8\text{ V}$	-18	—	+18	—	—	mV
			$1.8\text{ V} \leq V_{OUT}$	-1	—	+1	—	—	%
Line regulation	Reg·line	$V_{OUT} + 1\text{ V} \leq V_{IN} \leq 5.5\text{ V}$ $I_{OUT} = 1\text{ mA}$	—	5	—	—	12	mV	
Load regulation	Reg·load	$1\text{ mA} \leq I_{OUT} \leq 200\text{ mA}$ (Note 4)	—	13	—	—	28	mV	
Quiescent current	$I_{B(ON)}$	$I_{OUT} = 0\text{ mA}$, $V_{IN} = 5.5\text{ V}$ (Note 6)	—	1.2	—	—	2.2	μA	
Stand-by current	$I_{B(OFF)}$	$V_{CT} = 0\text{ V}$, $V_{IN} = 5.5\text{ V}$ (Note 6)	—	0.1	—	—	0.2	μA	
Control pull down current	I_{CT}	—	—	0.1	—	—	0.2	μA	
Drop-out voltage (Note 9)	V_{DO}	$I_{OUT} = 200\text{ mA}$	$V_{OUT} = 1.8\text{ V}$	—	344	—	—	445	mV
			$V_{OUT} = 2.8\text{ V}$	—	213	—	—	290	mV
			$V_{OUT} = 3.3\text{ V}$	—	177	—	—	251	mV
			$V_{OUT} = 5.0\text{ V}$	—	137	—	—	205	mV
Output noise voltage	V_{NO}	$V_{IN} = V_{OUT} + 1\text{ V}$ $I_{OUT} = 10\text{ mA}$ $10\text{ Hz} \leq f \leq 100\text{ kHz}$, $T_a = 25^\circ\text{C}$ (Note 4)	—	53	—	—	—	μV_{rms}	
Ripple rejection ratio	R.R.	$V_{IN} = V_{OUT} + 1\text{ V}$ $I_{OUT} = 10\text{ mA}$, $V_{Ripple} = 200\text{ mV}_{p-p}$, $T_a = 25^\circ\text{C}$ (Note 4)	$f = 100\text{ Hz}$	—	74	—	—	—	dB
			$f = 1\text{ kHz}$	—	66	—	—	—	
			$f = 10\text{ kHz}$	—	50	—	—	—	
			$f = 100\text{ kHz}$	—	43	—	—	—	
Load transient response	ΔV_{OUT}	$I_{OUT} = 1\text{ mA} \rightarrow 100\text{ mA}$ (Note 5)	—	-70	—	—	—	mV	
		$I_{OUT} = 100\text{ mA} \rightarrow 1\text{ mA}$ (Note 5)	—	+35	—	—	—		
Output current limit	I_{CL}	$V_{OUT} = V_{OUT(NOM)} * 90\%$ (Note 7)	—	—	—	300	450	mA	
Thermal shutdown threshold	T_{SDH}	T_j rising	—	160	—	—	—	$^\circ\text{C}$	
	T_{SDL}	T_j falling	—	140	—	—	—	$^\circ\text{C}$	
Control pin threshold voltage	V_{CTH}	Control pin input voltage "HIGH"	—	—	—	0.9	5.0	V	
	V_{CTL}	Control pin input voltage "LOW"	—	—	—	—	0.4	V	
Discharge on resistance	R_{SD}	(Note 5)	—	25	—	—	—	Ω	

Note 3: stable state with fixed I_{OUT} condition

Note 4: $V_{OUT} = 0.8\text{ V}$

Note 5: $V_{OUT} = 2.8\text{ V}$

Note 6: except Control pull down current (I_{CT})

Note 7: Pulse measurement

Note 8: This parameter is warranted by design.

Note 9: $V_{DO} = V_{IN1} - (V_{OUT1} \times 0.97)$

V_{OUT1} is the output voltage when $V_{IN} = V_{OUT} + 1.0\text{ V}$.

V_{IN1} is the input voltage at which the output voltage becomes 97% of V_{OUT1} after gradually decreasing the input voltage.

10. Dropout voltage table

($C_{IN} = 0.47 \mu\text{F}$, $C_{OUT} = 0.47 \mu\text{F}$)

Output voltages	$I_{OUT} = 200 \text{ mA}$			Unit
	Min	Typ.	Max (Note 10)	
$0.8 \text{ V} \leq V_{OUT} < 1.5 \text{ V}$	—	(Note 11)	(Note 11)	mV
1.5 V	—	500 (Note 11)	615 (Note 11)	mV
1.6 V	—	441	550	mV
1.7 V	—	382	485	mV
1.8 V, 1.85 V	—	344	445	mV
1.9 V, 1.95 V	—	331	425	mV
2.0 V	—	318	410	mV
2.5 V	—	252	325	mV
2.6 V	—	239	310	mV
2.7 V	—	226	300	mV
2.8 V, 2.85 V	—	213	290	mV
2.9 V	—	202	282	mV
3.0 V, 3.1 V	—	192	274	mV
3.2 V	—	182	259	mV
3.3 V	—	177	251	mV
3.5 V, 3.6 V	—	173	244	mV
4.2 V	—	156	230	mV
4.5 V	—	149	221	mV
5.0 V	—	137	205	mV

Note 10: $T_j = -40$ to 85°C . This parameter is guaranteed by design

Note 11: Operating Voltage of V_{IN} should be over 2.5 V.

11. Application Note

11.1. Recommended Application Circuit

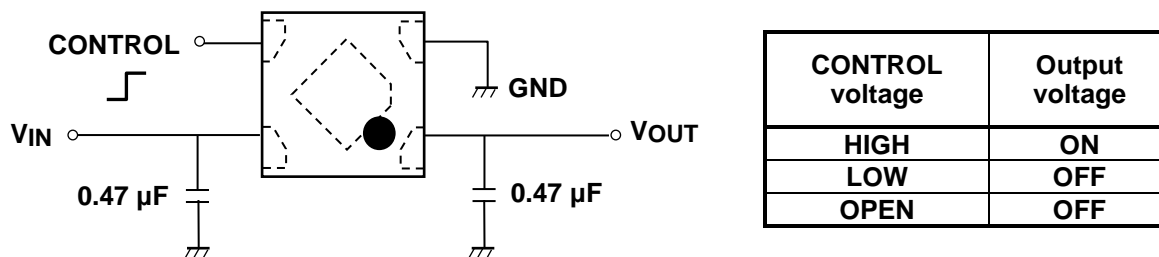

The figure above shows the recommended configuration for using a Low-Dropout regulator. Insert a capacitor at V_{OUT} and V_{IN} pins for stable input/output operation. (Ceramic capacitors can be used).

11.2. Power Dissipation

Board-mounted power dissipation ratings for TCR3LM series are available in the Absolute Maximum Ratings table. Power dissipation is measured on the board condition shown below.

[The Board Condition]

Board material: Glass epoxy (FR4)

Board dimension: 40 mm x 40 mm (both sides of board), t= 1.6 mm

Metal pattern ratio: a surface approximately 50%, the reverse side approximately 50%

Through hole: diameter 0.5 mm x 24 pcs

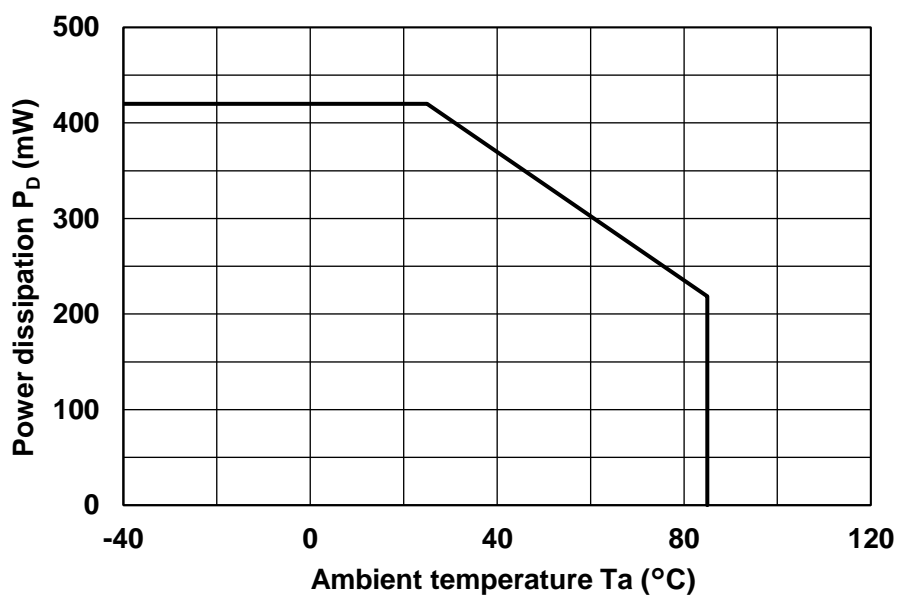

11.3. Attention in Use

- **Output Capacitors**
Ceramic capacitors can be used for these devices. However, because of the type of the capacitors, there might be unexpected thermal features. Please consider application condition for selecting capacitors. And Toshiba recommend ceramic capacitor.
- **TCR3LM series has Bias current; $I_{B(ON)}$ characteristic that controlled depending on I_{OUT} .**
When the output current required is very low, TCR3LM series operates with low $I_{B(ON)}$. In this state, load transient response characteristic are inferior than normal characteristics.
Regarding output current that switches $I_{B(ON)}$ state, TCR3LM series has hysteresis to control. When output current is increased, good load transient response characteristics are provided with $I_{B(ON)}$ becoming high. In the case of decreasing the I_{OUT} , TCR3LM series keeps good characteristics until the $I_{B(ON)}$ switches to a low state.
- **Mounting**
The long distance between IC and output capacitor might affect phase assurance by impedance in wire and inductor. For stable power supply, output capacitor need to mount near IC as much as possible. Also VIN and GND pattern need to be large and make the wire impedance small as possible.
- **Permissible Loss**
Please have enough design patterns for expected maximum permissible loss. And under consideration of surrounding temperature, input voltage, and output current etc., we recommend proper dissipation ratings for maximum permissible loss; in general maximum dissipation rating is 70 to 80 %.
- **Over current Protection and Thermal shut down function**
Over current protection and Thermal shut down function are designed in these products, but these are not designed to constantly ensure the suppression of the device within operation limits. Depending on the condition during actual usage, it could affect the electrical characteristic specification and reliability. Also note that if output pins and GND pins are not completely shorted out, these products might be break down. When using these products, please read through and understand the concept of dissipation for absolute maximum ratings from the above mention or our 'Semiconductor Reliability Handbook'. Then use these products under absolute maximum ratings in any condition. Furthermore, Toshiba recommend inserting failsafe system into the design.

12. Representation Typical Characteristics

12.1. Output Voltage vs. Output Current

($V_{IN} = 2.5\text{ V}$ ($V_{OUT} = 0.8\text{ V}$) or 3.8 V ($V_{OUT} = 2.8\text{ V}$) or 5.5 V ($V_{OUT} = 5.0\text{ V}$))

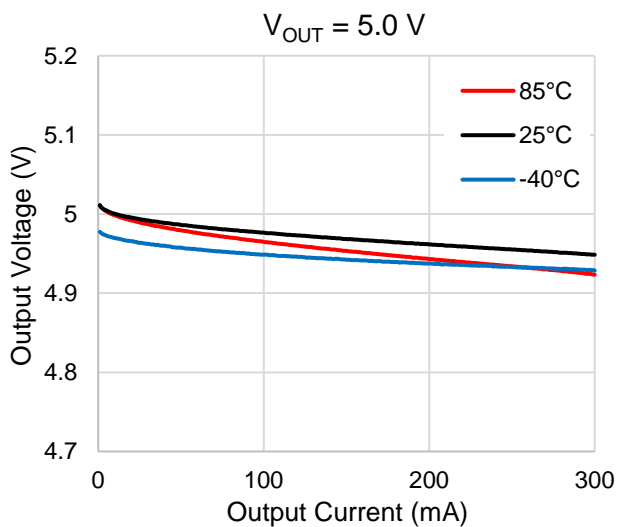
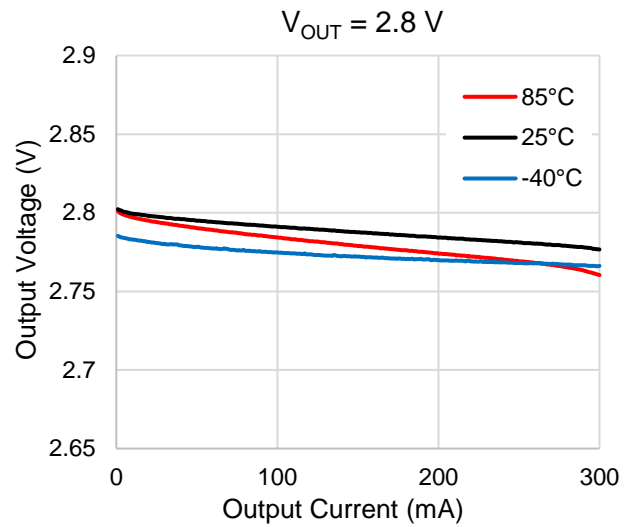
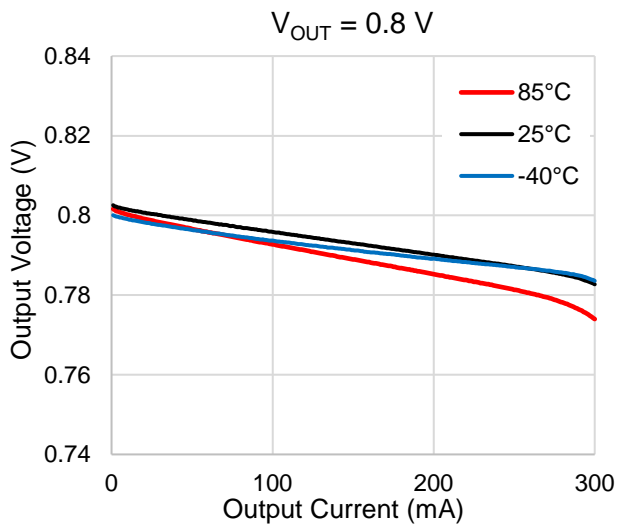

Note: The above characteristics curves are presented for reference only and not guaranteed by production test, unless otherwise noted.

12.2. Output Voltage vs. Input Voltage

($I_{OUT} = 1 \text{ mA}$, $T_a = 25^\circ\text{C}$)

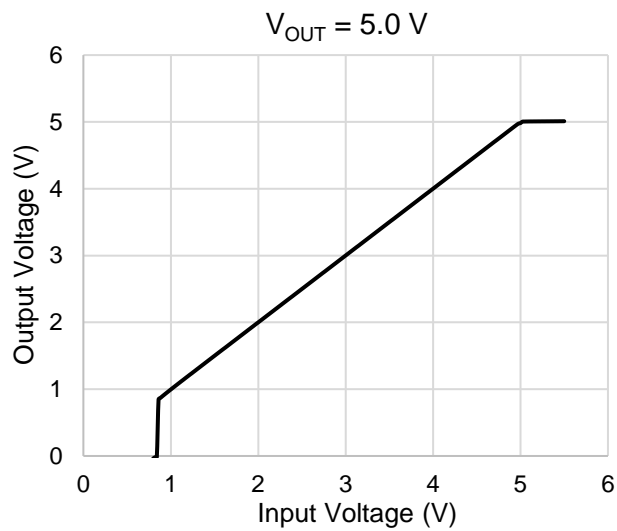
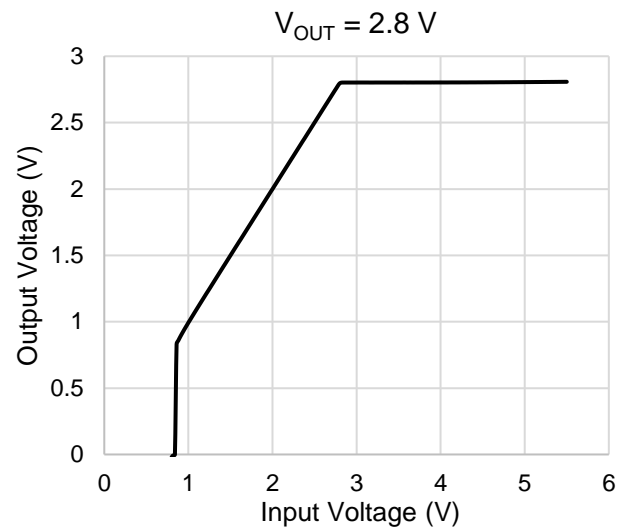
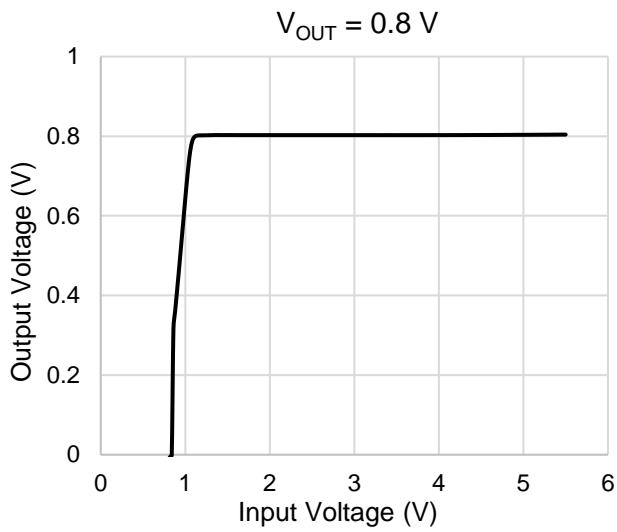

Note: The above characteristics curves are presented for reference only and not guaranteed by production test, unless otherwise noted.

12.3. Dropout Voltage vs. Output Current

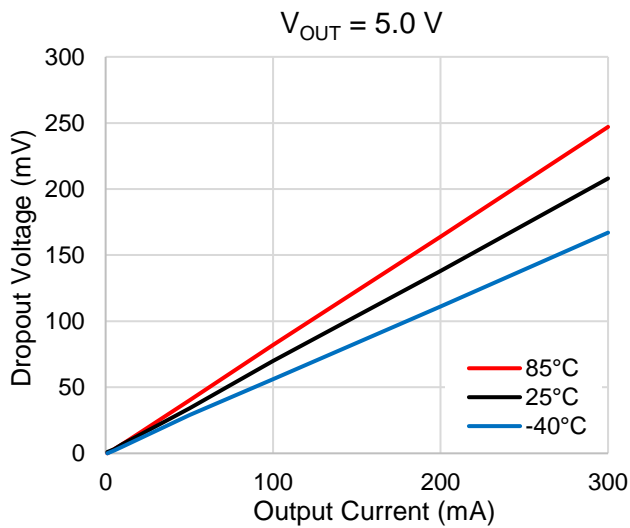
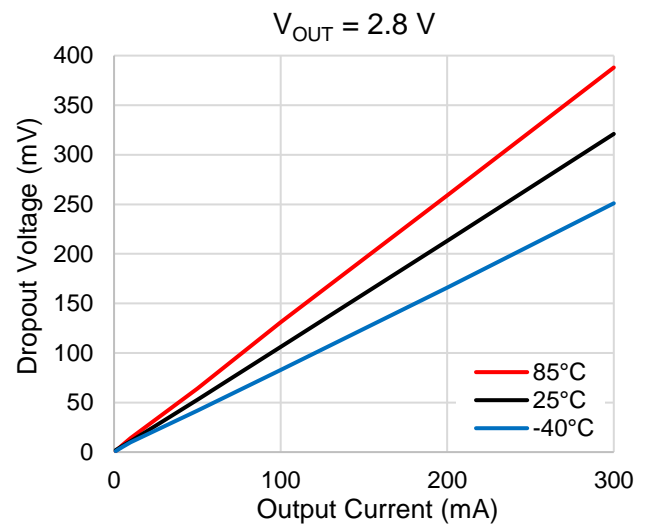
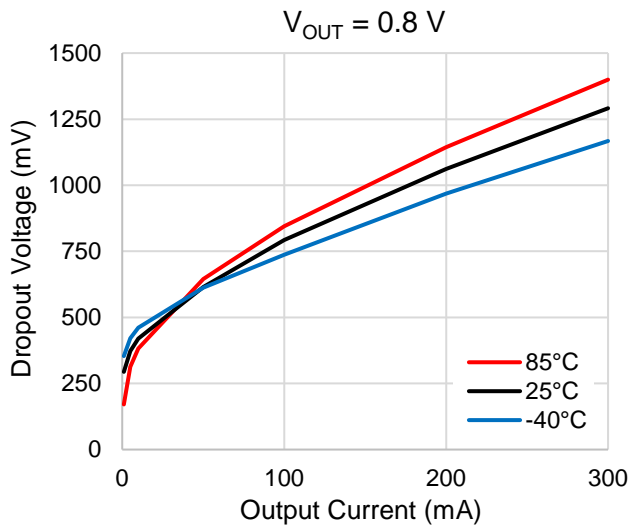

Note: The above characteristics curves are presented for reference only and not guaranteed by production test, unless otherwise noted.

12.4. Quiescent Current vs. Input Voltage

($I_{OUT} = 0 \text{ mA}$)

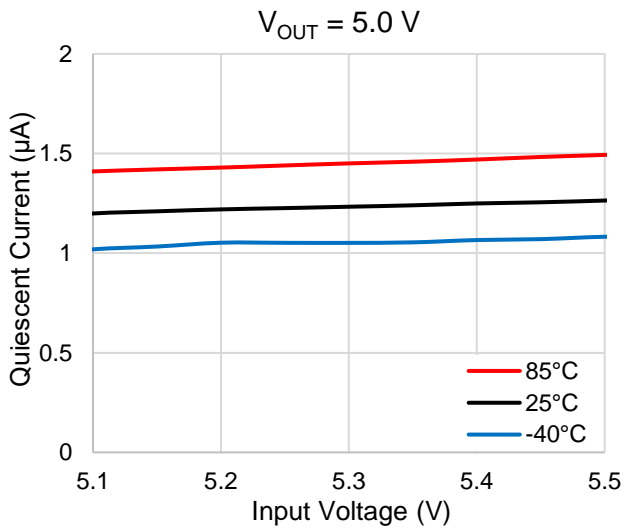
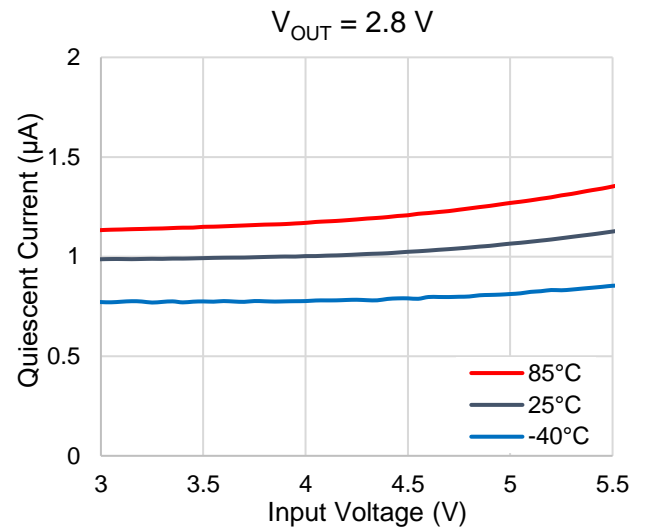
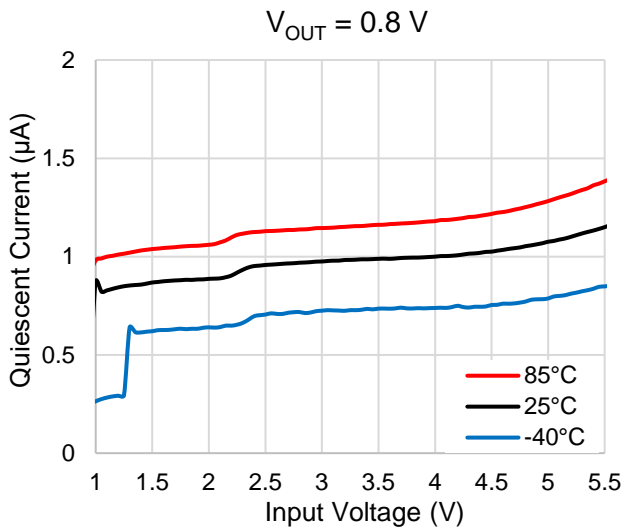

Note: The above characteristics curves are presented for reference only and not guaranteed by production test, unless otherwise noted.

12.5. Quiescent Current vs. Output Current

($V_{IN} = 2.5\text{ V}$ ($V_{OUT} = 0.8\text{ V}$) or 3.8 V ($V_{OUT} = 2.8\text{ V}$) or 5.5 V ($V_{OUT} = 5.0\text{ V}$), $I_{OUT} = 0\text{ A} \Leftrightarrow 200\text{ }\mu\text{A}$, $T_a = 25^\circ\text{C}$)

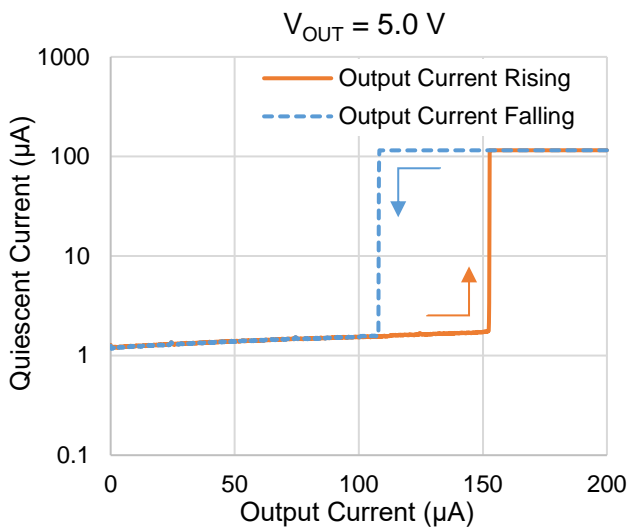
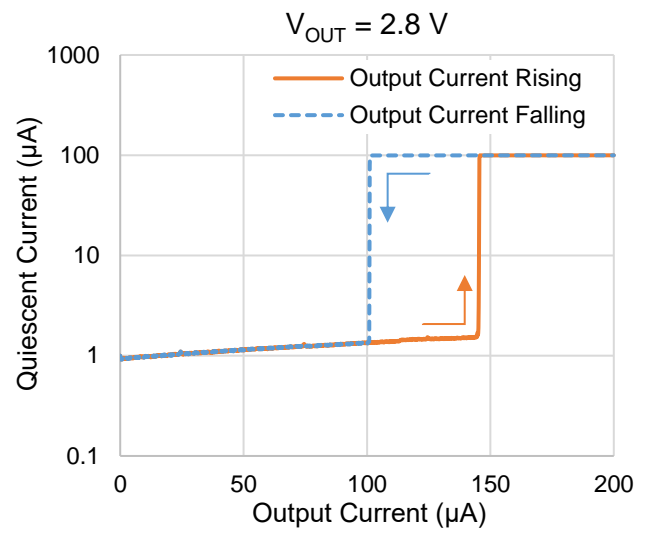
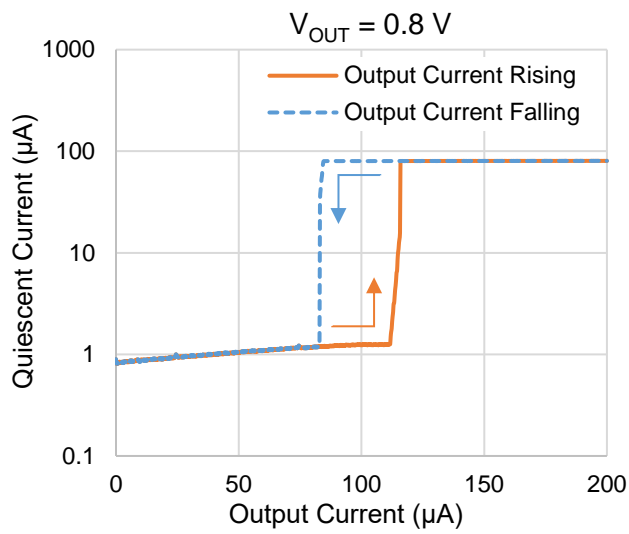

Note: The above characteristics curves are presented for reference only and not guaranteed by production test, unless otherwise noted.

12.6. Output Current Limit

($V_{IN} = 2.5\text{ V}$ ($V_{OUT} = 0.8\text{ V}$) or 3.8 V ($V_{OUT} = 2.8\text{ V}$) or 5.5 V ($V_{OUT} = 5.0\text{ V}$), $T_a = 25^\circ\text{C}$)

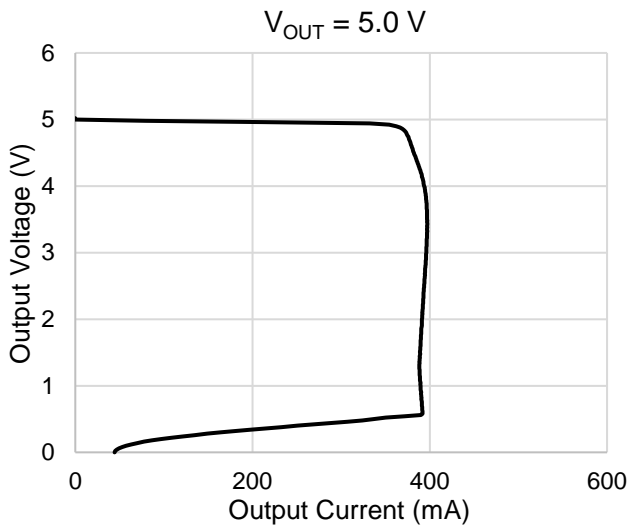
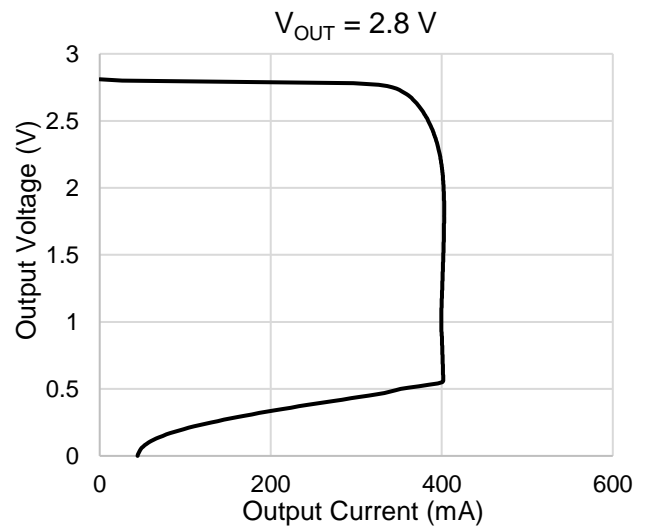
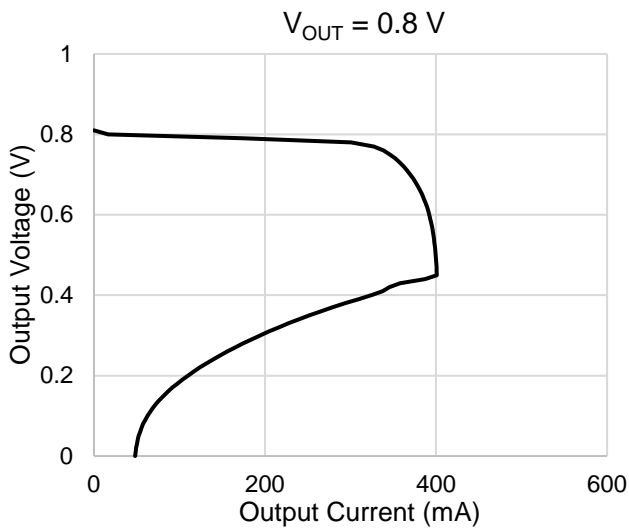

Note: The above characteristics curves are presented for reference only and not guaranteed by production test, unless otherwise noted.

12.7. Ripple rejection Ratio vs. Frequency

(C_{IN} = none, C_{OUT} = 0.47 μ F, V_{IN} = 2.5 V (V_{OUT} = 0.8 V) or 3.8 V (V_{OUT} = 2.8 V) or 5.5 V (V_{OUT} = 5.0 V), V_{IN} Ripple = 200 mV_{p-p}, I_{OUT} = 10 mA, T_a = 25°C)

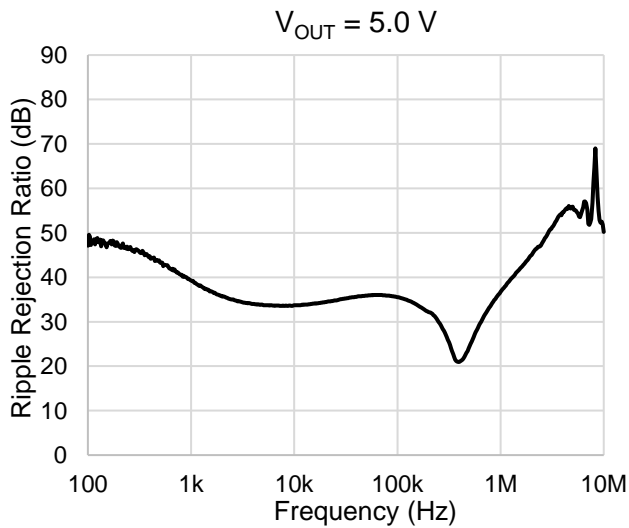
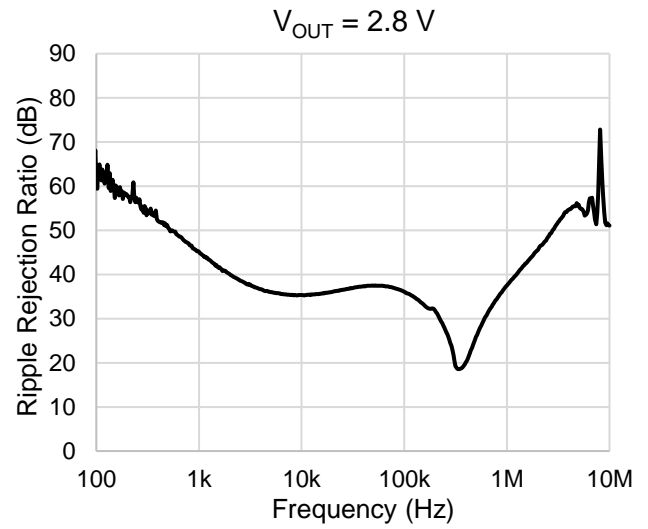
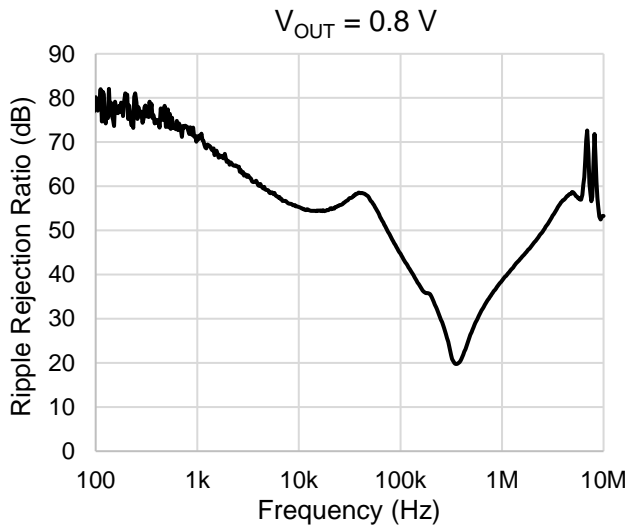

Note: The above characteristics curves are presented for reference only and not guaranteed by production test, unless otherwise noted.

12.8. Load Transient Response

($C_{IN} = 0.47 \mu\text{F}$, $C_{OUT} = 0.47 \mu\text{F}$, $V_{IN} = 2.5 \text{ V}$ ($V_{OUT} = 0.8 \text{ V}$) or 3.8 V ($V_{OUT} = 2.8 \text{ V}$) or 5.5 V ($V_{OUT} = 5.0 \text{ V}$), $t_r = 1.0 \mu\text{s}$, $t_f = 1.0 \mu\text{s}$, $T_a = 25^\circ\text{C}$)

$V_{OUT} = 0.8 \text{ V}$

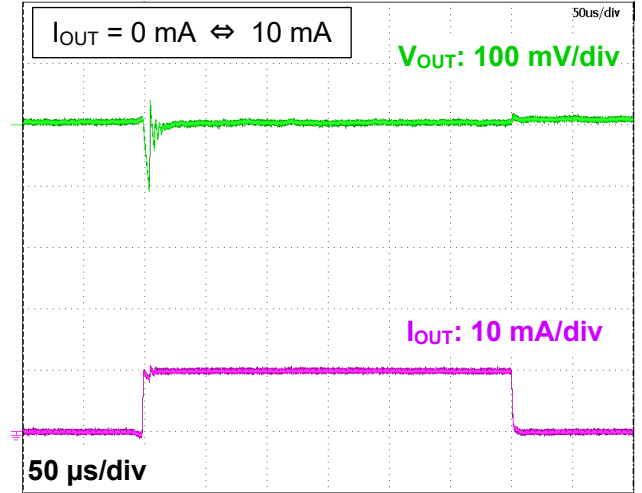
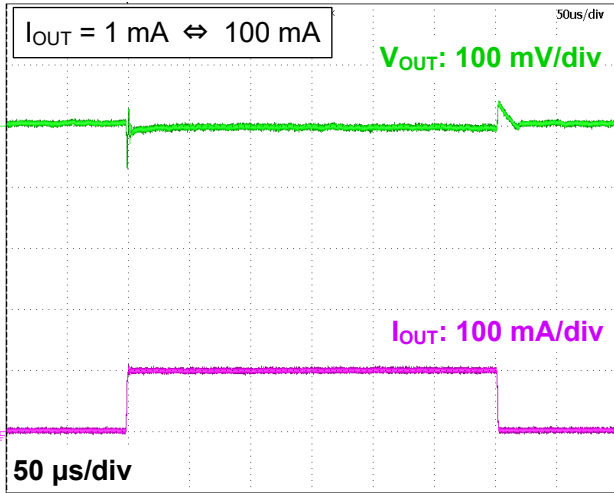

$V_{OUT} = 2.8 \text{ V}$

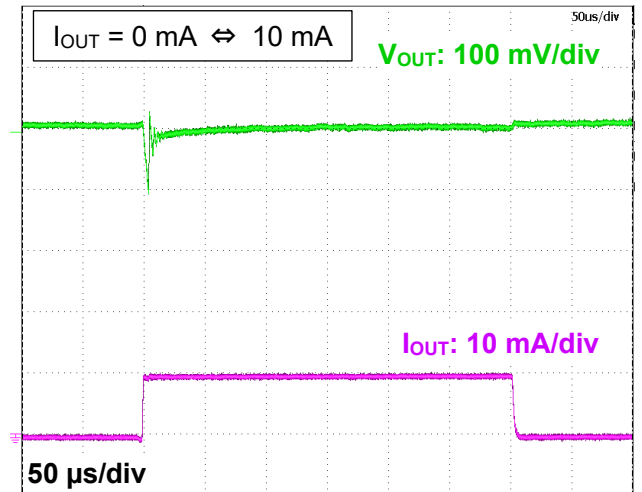
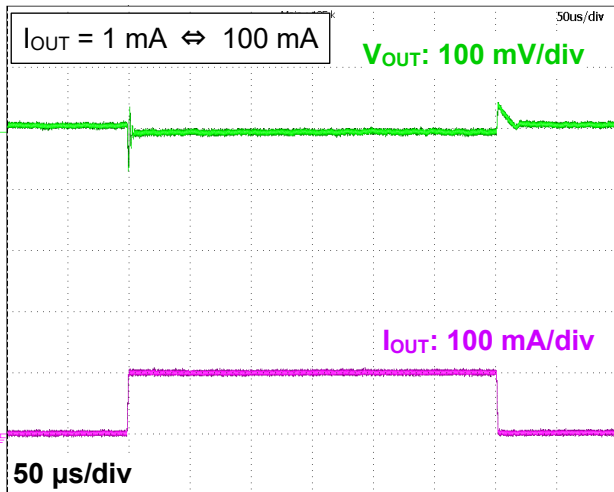

$V_{OUT} = 5.0 \text{ V}$

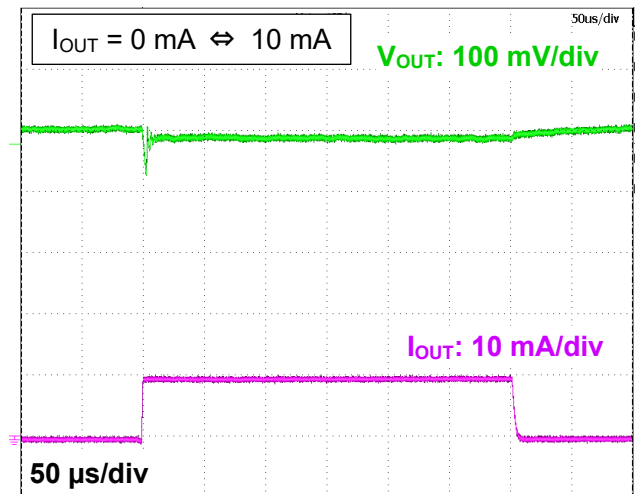
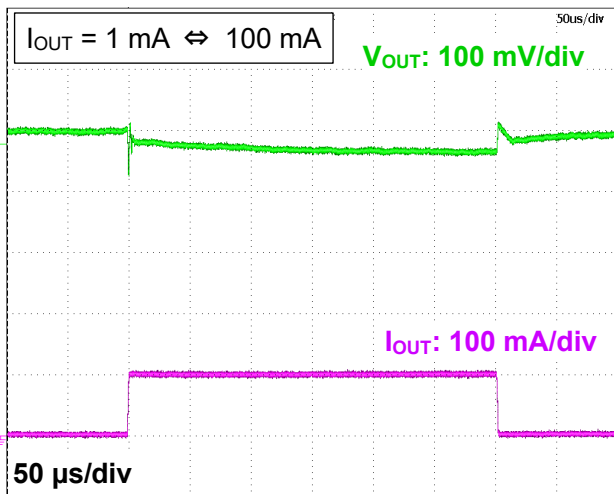

Note: The above characteristics curves are presented for reference only and not guaranteed by production test, unless otherwise noted.

12.9. t_{ON}/t_{OFF} Response

($C_{IN} = 0.47 \mu F$, $C_{OUT} = 0.47 \mu F$, $V_{IN} = 2.5 V$ ($V_{OUT} = 0.8 V$) or $3.8 V$ ($V_{OUT} = 2.8 V$) or $5.5 V$ ($V_{OUT} = 5.0 V$), $I_{OUT} = 0 mA$, $V_{CT} = 0 V \Leftrightarrow 1.0 V$, $T_a = 25^\circ C$)

$V_{OUT} = 0.8 V$

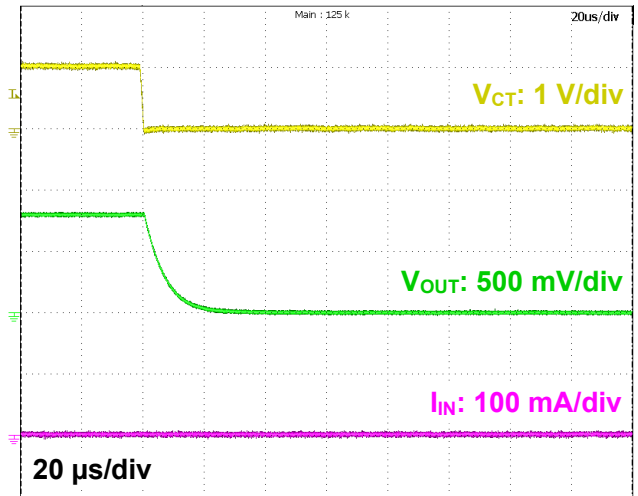
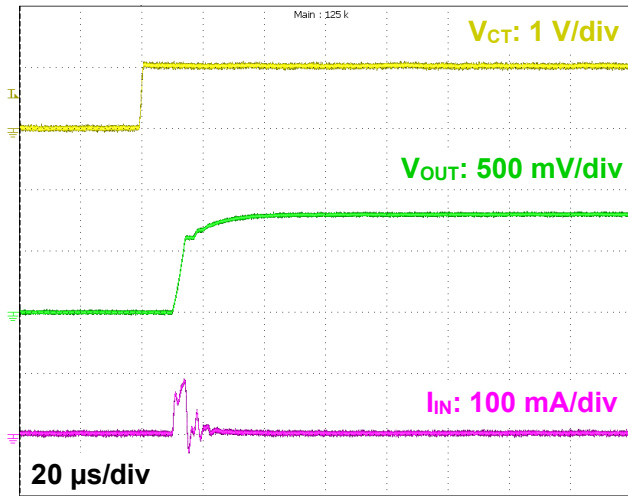

$V_{OUT} = 2.8 V$

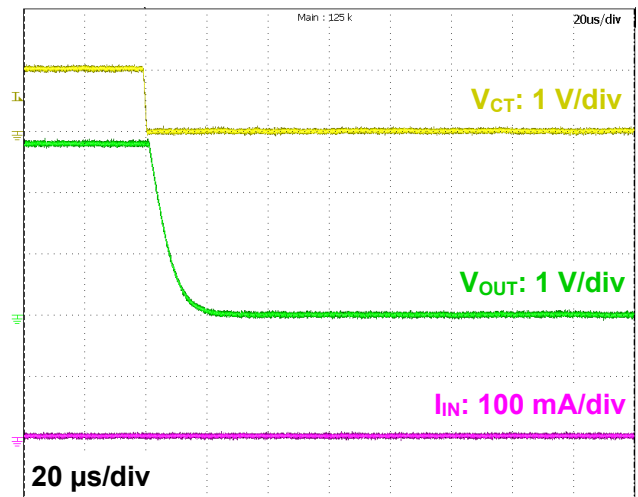
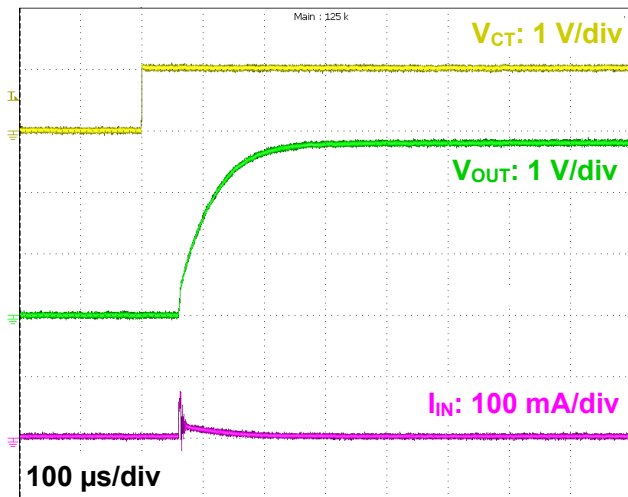

$V_{OUT} = 5.0 V$

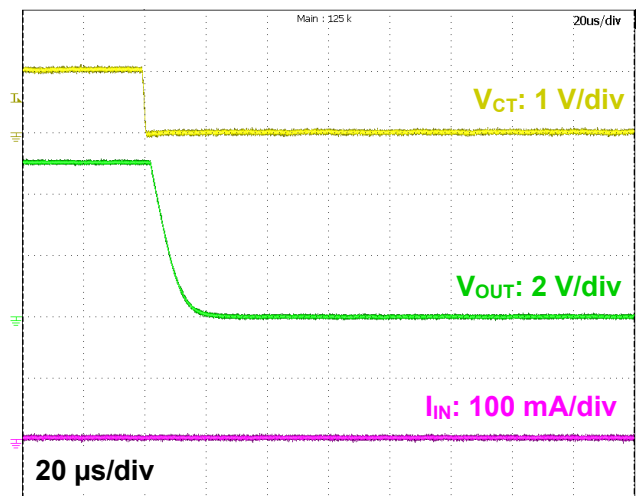
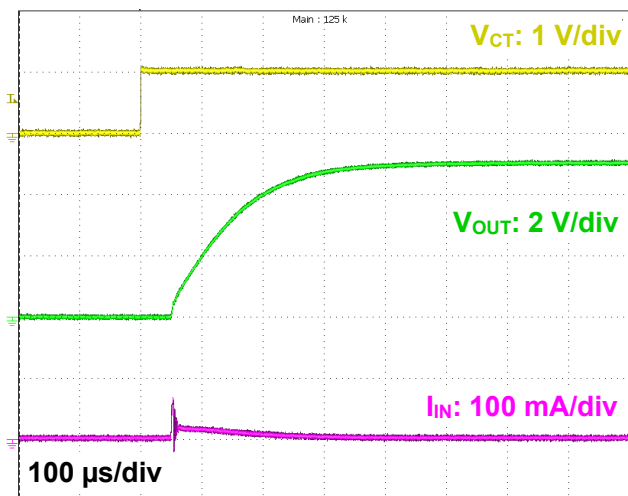

Note: The above characteristics curves are presented for reference only and not guaranteed by production test, unless otherwise noted.

13. Package Information

DFN4D

Unit: mm

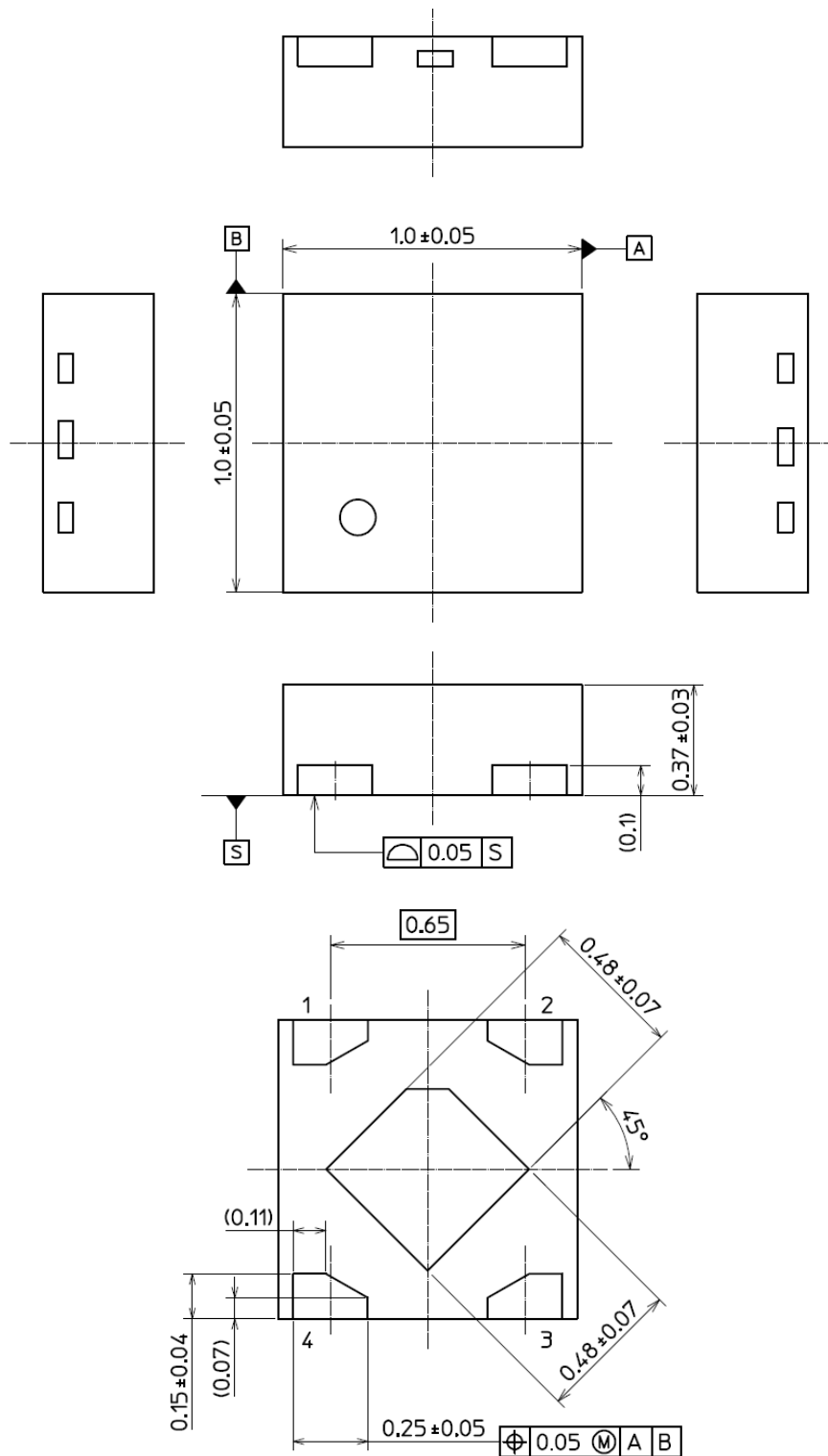

Weight: 1.1 mg (typ.)

14. Land Pattern Dimensions (for reference only)

Unit: mm

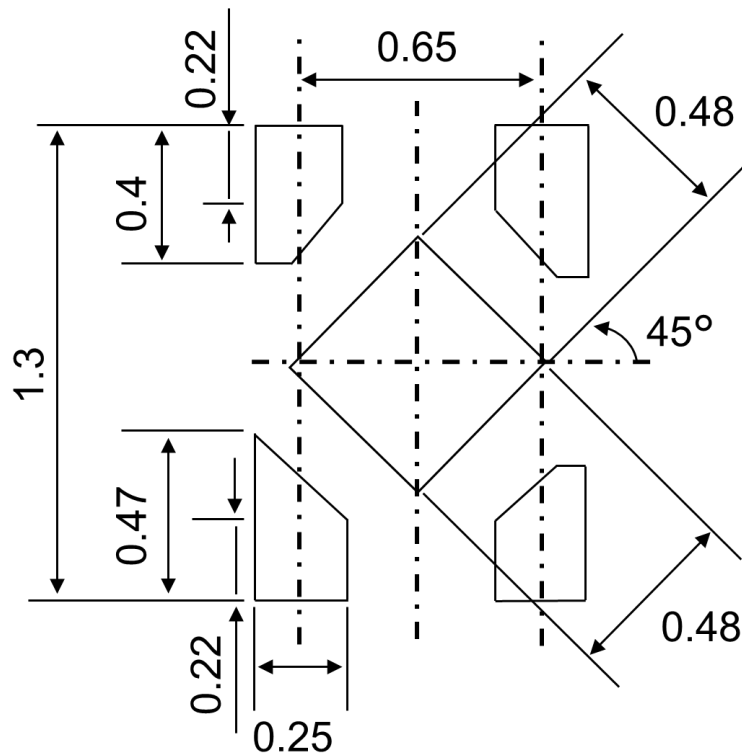

RESTRICTIONS ON PRODUCT USE

Toshiba Corporation and its subsidiaries and affiliates are collectively referred to as "TOSHIBA". Hardware, software and systems described in this document are collectively referred to as "Product".

- TOSHIBA reserves the right to make changes to the information in this document and related Product without notice.
- This document and any information herein may not be reproduced without prior written permission from TOSHIBA. Even with TOSHIBA's written permission, reproduction is permissible only if reproduction is without alteration/omission.
- Though TOSHIBA works continually to improve Product's quality and reliability, Product can malfunction or fail. Customers are responsible for complying with safety standards and for providing adequate designs and safeguards for their hardware, software and systems which minimize risk and avoid situations in which a malfunction or failure of Product could cause loss of human life, bodily injury or damage to property, including data loss or corruption. Before customers use the Product, create designs including the Product, or incorporate the Product into their own applications, customers must also refer to and comply with (a) the latest versions of all relevant TOSHIBA information, including without limitation, this document, the specifications, the data sheets and application notes for Product and the precautions and conditions set forth in the "TOSHIBA Semiconductor Reliability Handbook" and (b) the instructions for the application with which the Product will be used with or for. Customers are solely responsible for all aspects of their own product design or applications, including but not limited to (a) determining the appropriateness of the use of this Product in such design or applications; (b) evaluating and determining the applicability of any information contained in this document, or in charts, diagrams, programs, algorithms, sample application circuits, or any other referenced documents; and (c) validating all operating parameters for such designs and applications. **TOSHIBA ASSUMES NO LIABILITY FOR CUSTOMERS' PRODUCT DESIGN OR APPLICATIONS.**
- **PRODUCT IS NEITHER INTENDED NOR WARRANTED FOR USE IN EQUIPMENTS OR SYSTEMS THAT REQUIRE EXTRAORDINARILY HIGH LEVELS OF QUALITY AND/OR RELIABILITY, AND/OR A MALFUNCTION OR FAILURE OF WHICH MAY CAUSE LOSS OF HUMAN LIFE, BODILY INJURY, SERIOUS PROPERTY DAMAGE AND/OR SERIOUS PUBLIC IMPACT ("UNINTENDED USE").** Except for specific applications as expressly stated in this document, Unintended Use includes, without limitation, equipment used in nuclear facilities, equipment used in the aerospace industry, lifesaving and/or life supporting medical equipment, equipment used for automobiles, trains, ships and other transportation, traffic signaling equipment, equipment used to control combustions or explosions, safety devices, elevators and escalators, and devices related to power plant. **IF YOU USE PRODUCT FOR UNINTENDED USE, TOSHIBA ASSUMES NO LIABILITY FOR PRODUCT.** For details, please contact your TOSHIBA sales representative or contact us via our website.
- Do not disassemble, analyze, reverse-engineer, alter, modify, translate or copy Product, whether in whole or in part.
- Product shall not be used for or incorporated into any products or systems whose manufacture, use, or sale is prohibited under any applicable laws or regulations.
- The information contained herein is presented only as guidance for Product use. No responsibility is assumed by TOSHIBA for any infringement of patents or any other intellectual property rights of third parties that may result from the use of Product. No license to any intellectual property right is granted by this document, whether express or implied, by estoppel or otherwise.
- **ABSENT A WRITTEN SIGNED AGREEMENT, EXCEPT AS PROVIDED IN THE RELEVANT TERMS AND CONDITIONS OF SALE FOR PRODUCT, AND TO THE MAXIMUM EXTENT ALLOWABLE BY LAW, TOSHIBA (1) ASSUMES NO LIABILITY WHATSOEVER, INCLUDING WITHOUT LIMITATION, INDIRECT, CONSEQUENTIAL, SPECIAL, OR INCIDENTAL DAMAGES OR LOSS, INCLUDING WITHOUT LIMITATION, LOSS OF PROFITS, LOSS OF OPPORTUNITIES, BUSINESS INTERRUPTION AND LOSS OF DATA, AND (2) DISCLAIMS ANY AND ALL EXPRESS OR IMPLIED WARRANTIES AND CONDITIONS RELATED TO SALE, USE OF PRODUCT, OR INFORMATION, INCLUDING WARRANTIES OR CONDITIONS OF MERCHANTABILITY, FITNESS FOR A PARTICULAR PURPOSE, ACCURACY OF INFORMATION, OR NONINFRINGEMENT.**
- Do not use or otherwise make available Product or related software or technology for any military purposes, including without limitation, for the design, development, use, stockpiling or manufacturing of nuclear, chemical, or biological weapons or missile technology products (mass destruction weapons). Product and related software and technology may be controlled under the applicable export laws and regulations including, without limitation, the Japanese Foreign Exchange and Foreign Trade Law and the U.S. Export Administration Regulations. Export and re-export of Product or related software or technology are strictly prohibited except in compliance with all applicable export laws and regulations.
- Please contact your TOSHIBA sales representative for details as to environmental matters such as the RoHS compatibility of Product. Please use Product in compliance with all applicable laws and regulations that regulate the inclusion or use of controlled substances, including without limitation, the EU RoHS Directive. **TOSHIBA ASSUMES NO LIABILITY FOR DAMAGES OR LOSSES OCCURRING AS A RESULT OF NONCOMPLIANCE WITH APPLICABLE LAWS AND REGULATIONS.**