

TOSHIBA CMOS Linear Integrated Circuit Silicon Monolithic

# TCR3DF Series

## 300 mA CMOS Low Drop-Out Regulator with inrush current protection circuit

The TCR3DF series are CMOS general-purpose single-output voltage regulators with an on/off control input, featuring low dropout voltage, low output noise voltage and low inrush current.

These voltage regulators are available in fixed output voltages between 1.0 V and 4.5 V and capable of driving up to 300 mA.

They feature over-current protection, over-temperature protection, Inrush current protection circuit and Auto-discharge function.

The TCR3DF series has a low dropout voltage of 230 mV (2.5 V output,  $I_{OUT} = 300$  mA) with low output noise voltage of  $38 \mu V_{rms}$  (2.5 V output) and a load transient response of only  $\Delta V_{OUT} = \pm 85$  mV ( $I_{OUT} = 1$  mA  $\leftrightarrow$  300 mA,  $C_{OUT} = 1.0 \mu F$ ).

Thus, the TCR3DF series are suitable for sensitive power supply such as Analog and RF applications.

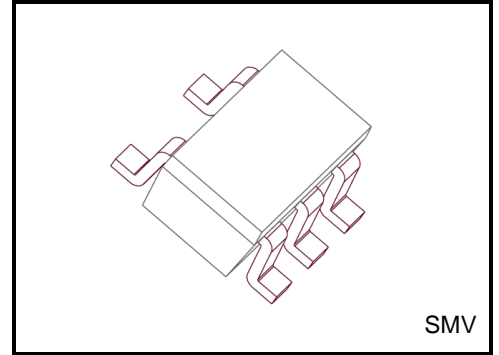

Weight:  
SMV (SOT-25) (SC-74A) : 16 mg (Typ.)

## Features

- Low Drop-Out voltage
  - $V_{IN}-V_{OUT} = 230$  mV (typ.) at 2.5 V-output,  $I_{OUT} = 300$  mA
  - $V_{IN}-V_{OUT} = 290$  mV (typ.) at 1.8 V-output,  $I_{OUT} = 300$  mA
  - $V_{IN}-V_{OUT} = 510$  mV (typ.) at 1.2 V-output,  $I_{OUT} = 300$  mA
- Low output noise voltage
  - $V_{NO} = 38 \mu V_{rms}$  (typ.) at 2.5 V-output,  $I_{OUT} = 10$  mA,  $10$  Hz  $\leq f \leq 100$  kHz
- Fast load transient response ( $\Delta V_{OUT} = \pm 85$  mV (typ.) at  $I_{OUT} = 1 \leftrightarrow 300$  mA,  $C_{OUT} = 1.0 \mu F$ )
- High ripple rejection ( R.R = 70 dB (typ.) at 2.5 V-output,  $I_{OUT} = 10$  mA,  $f = 1$  kHz )
- Over-current protection
- Over-temperature protection
- Inrush current protection circuit
- Auto-discharge function
- Pull down connection between CONTROL and GND
- Ceramic capacitors can be used (  $C_{IN} = 1.0 \mu F$ ,  $C_{OUT} = 1.0 \mu F$  )
- General purpose package SMV(SOT-25) (SC-74A)

Start of commercial production  
2013-11

### Absolute Maximum Ratings (Ta = 25 °C)

Characteristics	Symbol	Rating	Unit
Input voltage	V <sub>IN</sub>	6.0	V
Control voltage	V <sub>CT</sub>	-0.3 to 6.0	V
Output voltage	V <sub>OUT</sub>	-0.3 to V <sub>IN</sub> + 0.3	V
Output current	I <sub>OUT</sub>	300	mA
Power dissipation	P <sub>D</sub>	200 (Note1)	mW
		580 (Note2)	
Operation temperature range	T <sub>opr</sub>	-40 to 85	°C
Junction temperature	T <sub>j</sub>	150	°C
Storage temperature range	T <sub>stg</sub>	-55 to 150	°C

Note: Using continuously under heavy loads (e.g. the application of high temperature/current/voltage and the significant change in temperature, etc.) may cause this product to decrease in the reliability significantly even if the operating conditions (i.e. operating temperature/current/voltage, etc.) are within the absolute maximum ratings and the operating ranges.

Please design the appropriate reliability upon reviewing the Toshiba Semiconductor Reliability Handbook (“Handling Precautions”/“Derating Concept and Methods”) and individual reliability data (i.e. reliability test report and estimated failure rate, etc).

Note 1: Unit Rating

Note 2: Rating at mounting on a board  
(FR4 board: 25.4 mm x 25.4 mm x 1.6 mm)

### Pin Assignment (top view)

#### SMV(SOT-25)(SC-74A)

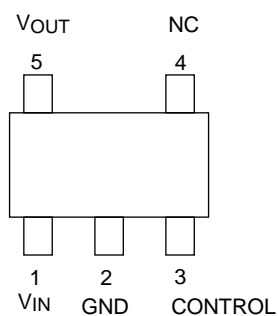

### List of Products Number, Output voltage and Marking

Product No.	Output voltage(V)	Marking	Product No.	Output voltage(V)	Marking
TCR3DF10	1.0	1P0	TCR3DF275	2.75	2PF
TCR3DF105	1.05	1PA	TCR3DF28	2.8	2P8
TCR3DF11	1.1	1P1	TCR3DF285	2.85	2PD
TCR3DF12	1.2	1P2	TCR3DF29	2.9	2P9
TCR3DF125	1.25	1PC	TCR3DF295	2.95	2PE
TCR3DF13	1.3	1P3	TCR3DF30	3.0	3P0
TCR3DF15	1.5	1P5	TCR3DF31	3.1	3P1
TCR3DF17	1.7	1P7	TCR3DF32	3.2	3P2
TCR3DF18	1.8	1P8	TCR3DF33	3.3	3P3
TCR3DF185	1.85	1PF	TCR3DF335	3.35	3PD
TCR3DF19	1.9	1P9	TCR3DF36	3.6	3P6
TCR3DF24	2.4	2P4	TCR3DF39	3.9	3P9
TCR3DF25	2.5	2P5	TCR3DF40	4.0	4P0
TCR3DF27	2.7	2P7	TCR3DF45	4.5	4P5

Please ask your local retailer about the devices with other output voltages.

### Marking (top view)

Example: TCR3DF33 (3.3 V output)

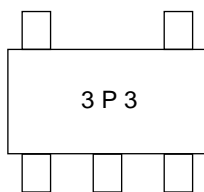

### Electrical Characteristics

(Unless otherwise specified,  $V_{IN} = V_{OUT} + 1\text{ V}$ ,  $I_{OUT} = 50\text{ mA}$ ,  $C_{IN} = 1.0\text{ }\mu\text{F}$ ,  $C_{OUT} = 1.0\text{ }\mu\text{F}$ ,  $T_j = 25^\circ\text{C}$ )

Characteristics	Symbol	Test Condition	Min	Typ.	Max	Unit	
Output voltage accuracy	$V_{OUT}$	$I_{OUT} = 50\text{ mA}$ (Note 3)	$V_{OUT} < 1.8\text{ V}$	-18	—	+18	mV
			$1.8\text{ V} \leq V_{OUT}$	-1.0	—	+1.0	%
Input voltage	$V_{IN}$	$I_{OUT} = 300\text{ mA}$	1.8	—	5.5	V	
Line regulation	Reg·line	$V_{OUT} + 0.5\text{ V} \leq V_{IN} \leq 5.5\text{ V}$ , $I_{OUT} = 1\text{ mA}$	—	1	15	mV	
Load regulation	Reg·load	$1\text{ mA} \leq I_{OUT} \leq 300\text{ mA}$	—	30	50	mV	
Quiescent current	$I_B$	$I_{OUT} = 0\text{ mA}$	$V_{OUT} = 1.0\text{ V}$	—	65	—	$\mu\text{A}$
			$V_{OUT} = 1.8\text{ V}$	—	65	—	
			$V_{OUT} = 2.5\text{ V}$	—	68	—	
			$V_{OUT} = 4.5\text{ V}$	—	78	125	
Stand-by current	$I_B$ (OFF)	$V_{CT} = 0\text{ V}$	—	0.1	1	$\mu\text{A}$	
Drop-out voltage	$V_{IN-V_{OUT}}$	$I_{OUT} = 300\text{ mA}$ (Note 4)	—	230	310	mV	
Temperature coefficient	$TC_{VO}$	$-40^\circ\text{C} \leq T_{opr} \leq 85^\circ\text{C}$	—	75	—	ppm/ $^\circ\text{C}$	
Output noise voltage	$V_{NO}$	$V_{IN} = V_{OUT} + 1\text{ V}$ , $I_{OUT} = 10\text{ mA}$ , $10\text{ Hz} \leq f \leq 100\text{ kHz}$ , $T_a = 25^\circ\text{C}$ (Note 4)	—	38	—	$\mu\text{V}_{rms}$	
Ripple rejection ratio	R.R.	$V_{IN} = V_{OUT} + 1\text{ V}$ , $I_{OUT} = 10\text{ mA}$ , $f = 1\text{ kHz}$ , $V_{Ripple} = 500\text{ mV}_{p-p}$ , $T_a = 25^\circ\text{C}$ (Note 4)	—	70	—	dB	
Load transient response	$\Delta V_{OUT}$	$I_{OUT} = 1 \leftrightarrow 300\text{ mA}$ , $C_{OUT} = 1.0\text{ }\mu\text{F}$	—	$\pm 85$	—	mV	
Control voltage (ON)	$V_{CT}$ (ON)	—	1.0	—	5.5	V	
Control voltage (OFF)	$V_{CT}$ (OFF)	—	0	—	0.4	V	

Note 3: Stable state with fixed  $I_{OUT}$  condition.

Note 4: The 2.5 V output product.

### Dropout voltage

( $I_{OUT} = 300\text{ mA}$ ,  $C_{IN} = 1.0\text{ }\mu\text{F}$ ,  $C_{OUT} = 1.0\text{ }\mu\text{F}$ ,  $T_j = 25^\circ\text{C}$ )

Output voltages	Symbol	Min	Typ.	Max	Unit
1.0 V, 1.05 V	$V_{IN-V_{OUT}}$	—	610	770	mV
1.1 V, 1.15 V		—	570	670	
1.2 V, 1.25 V		—	510	620	
1.3 V		—	470	570	
1.4 V		—	410	540	
$1.5\text{ V} \leq V_{OUT} < 1.8\text{ V}$		—	370	470	
$1.8\text{ V} \leq V_{OUT} < 2.1\text{ V}$		—	290	400	
$2.1\text{ V} \leq V_{OUT} < 2.5\text{ V}$		—	260	350	
$2.5\text{ V} \leq V_{OUT} < 2.8\text{ V}$		—	230	310	
$2.8\text{ V} \leq V_{OUT} < 3.2\text{ V}$		—	220	270	
$3.2\text{ V} \leq V_{OUT} < 3.6\text{ V}$		—	200	250	
$3.6\text{ V} \leq V_{OUT} \leq 4.5\text{ V}$		—	170	220	

## Application note

### Recommended Application Circuit

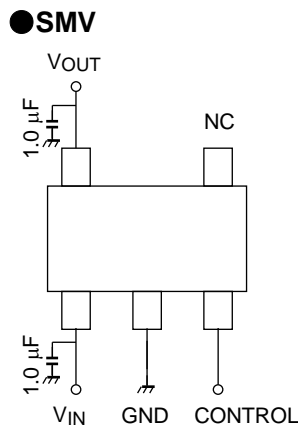

CONTROL voltage	Output voltage
HIGH	ON
LOW	OFF
OPEN	OFF

The figure above shows the recommended configuration for using a Low-Dropout regulator. Insert a capacitor at V<sub>OUT</sub> and V<sub>IN</sub> pins for stable input/output operation. (Ceramic capacitors can be used).

### Power Dissipation

Both unit and board-mounted power dissipation ratings for TCR3DF series are available in the Absolute Maximum Ratings table.

Power dissipation is measured on the board shown below.

### Testing Board of Thermal Resistance

\*Board material: FR4 board

Board dimension: 25.4 mm × 25.4 mm × 1.6 mm

Copper area: 645 mm<sup>2</sup>

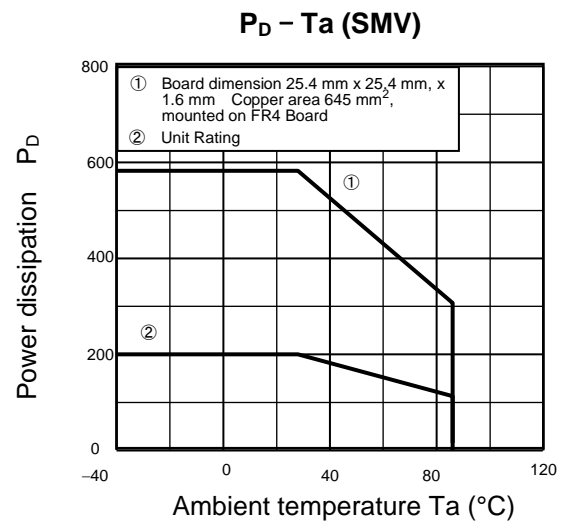

---

### Attention in Use

- **Output Capacitors**  
Ceramic capacitors can be used for these devices. However, because of the type of the capacitors, there might be unexpected thermal features. Please consider application condition for selecting capacitors. And Toshiba recommend the ESR of ceramic capacitor is under 10  $\Omega$ .
- **Mounting**  
The long distance between IC and output capacitor might affect phase assurance by impedance in wire and inductor. For stable power supply, output capacitor need to mount near IC as much as possible. Also VIN and GND pattern need to be large and make the wire impedance small as possible.
- **Permissible Loss**  
Please have enough design patterns for expected maximum permissible loss. And under consideration of surrounding temperature, input voltage, and output current etc, we recommend proper dissipation ratings for maximum permissible loss; in general maximum dissipation rating is 70 to 80 percent.
- **Over current Protection and Thermal shut down function**  
Over current protection and Thermal shut down function are designed in these products, but these are not designed to constantly ensure the suppression of the device within operation limits. Depending on the condition during actual usage, it could affect the electrical characteristic specification and reliability. Also note that if output pins and GND pins are not completely shorted out, these products might be break down.  
When using these products, please read through and understand the concept of dissipation for absolute maximum ratings from the above mention or our 'Semiconductor Reliability Handbook'. Then use these products under absolute maximum ratings in any condition. Furthermore, Toshiba recommend inserting failsafe system into the design.

### Representative Typical Characteristics

#### Output Voltage vs. Output Current

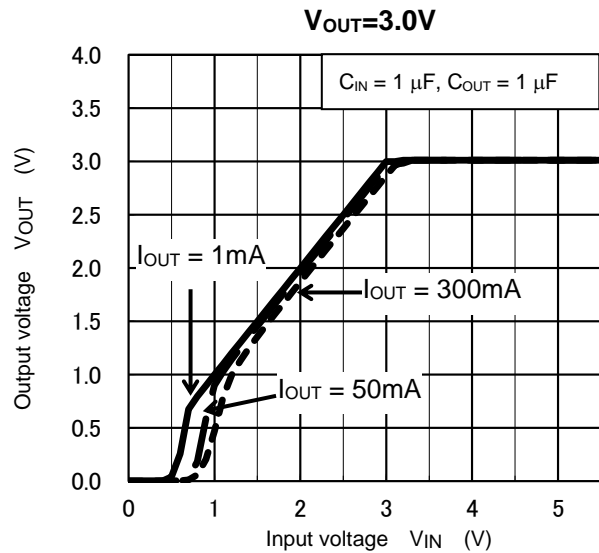
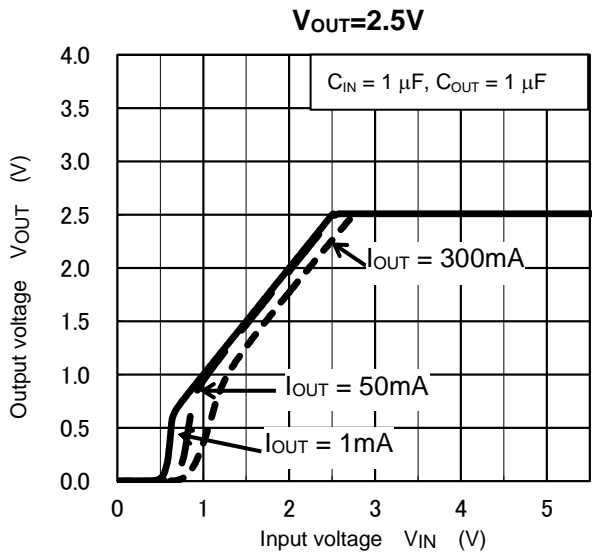
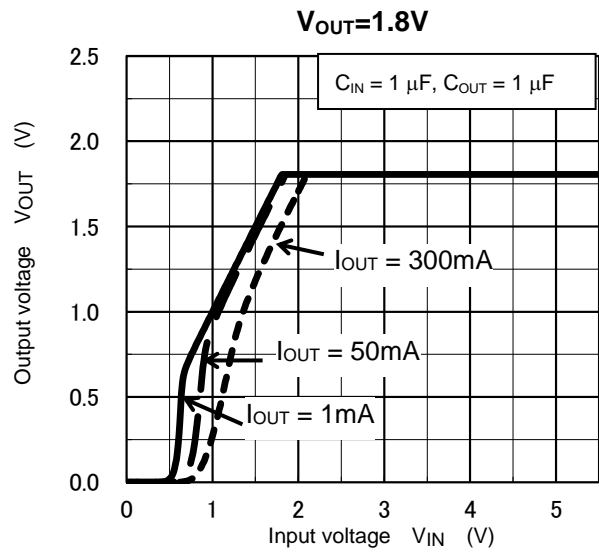
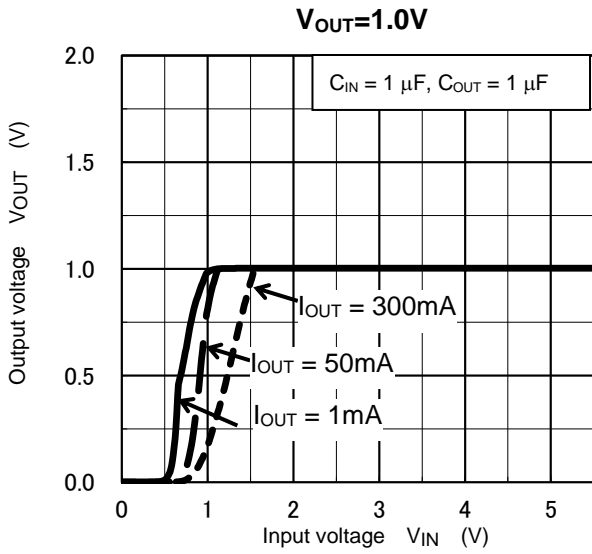

#### Output Voltage vs. Output Current

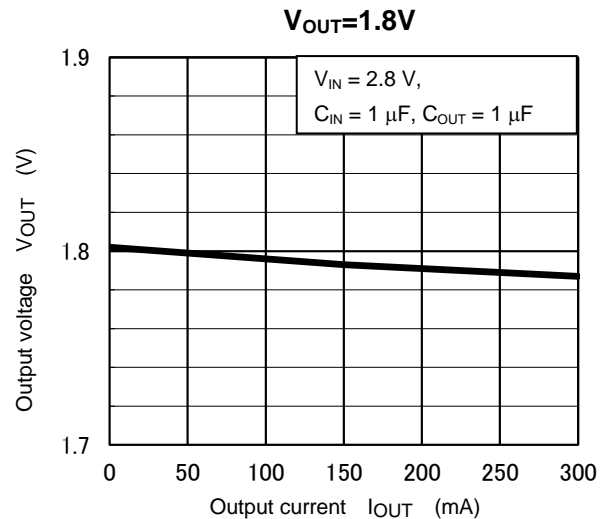
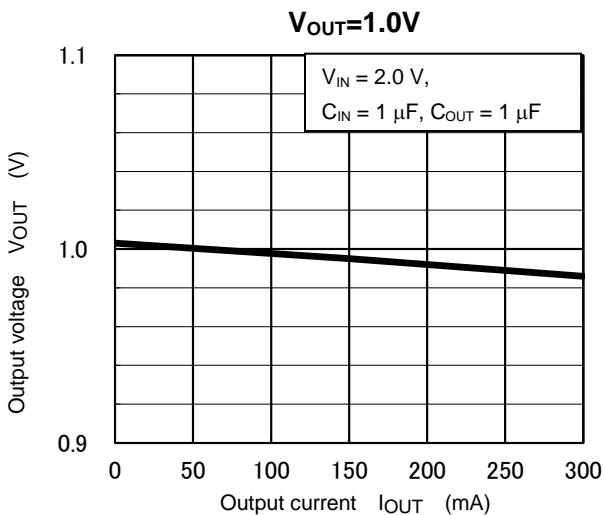

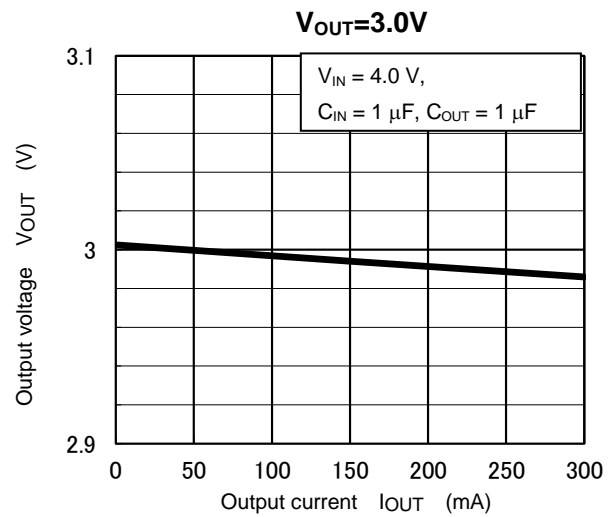
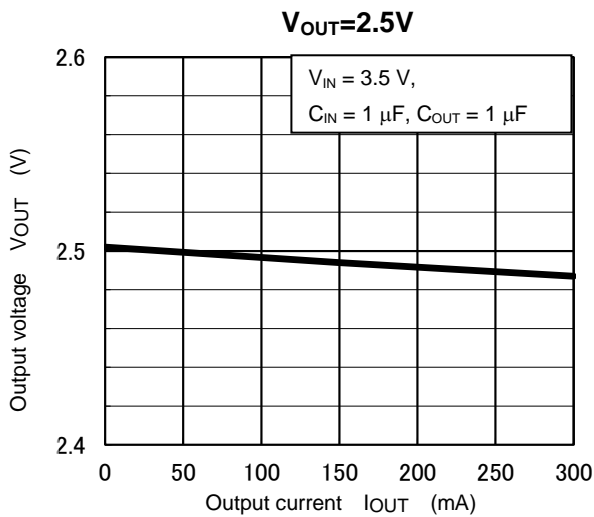

### Dropout Voltage vs. Output Current

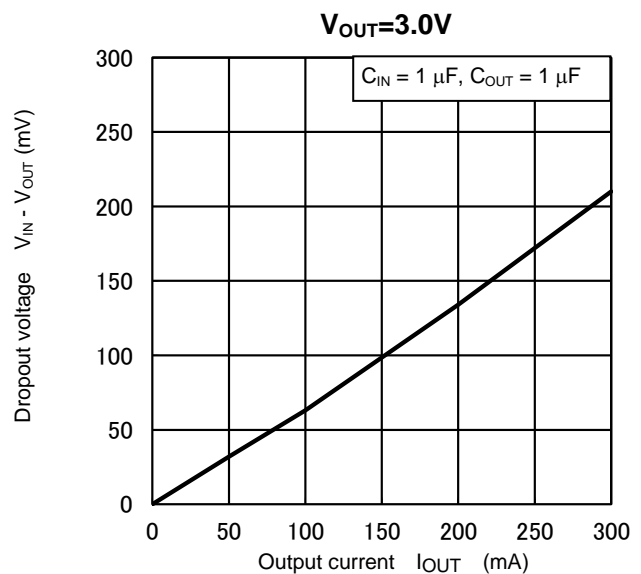
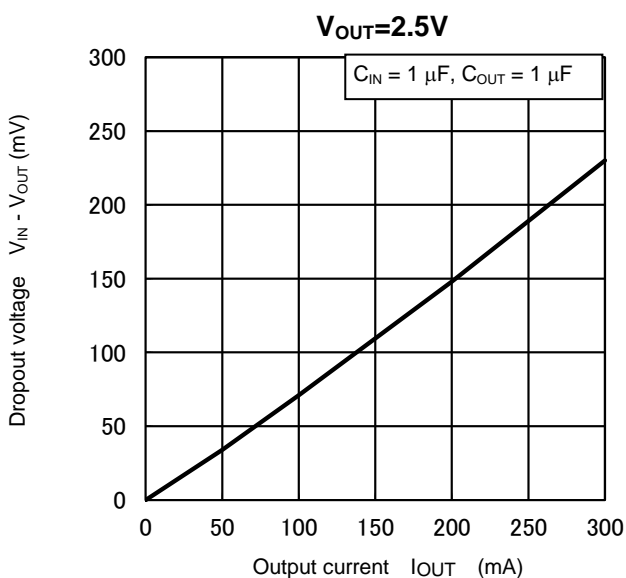
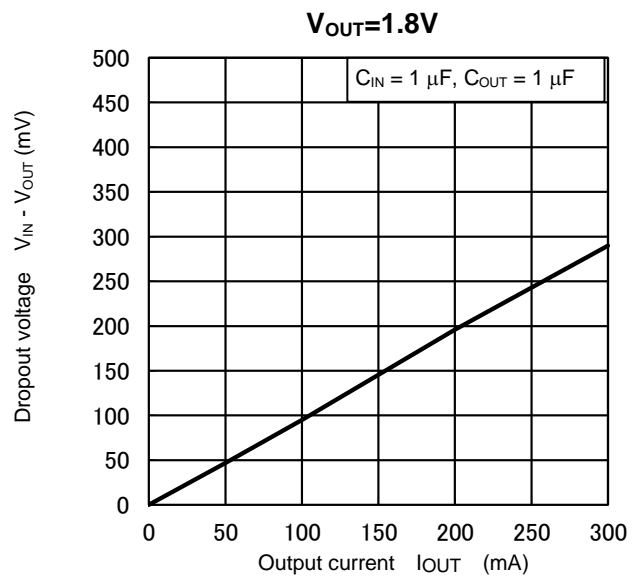
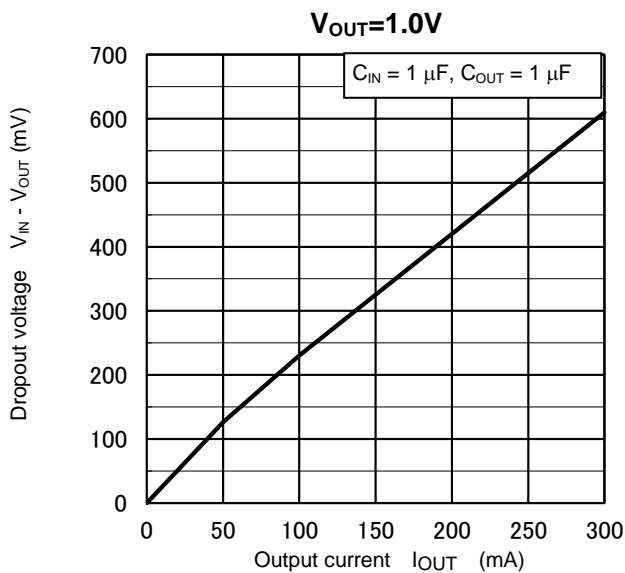



### Quiescent Current vs. Input Voltage

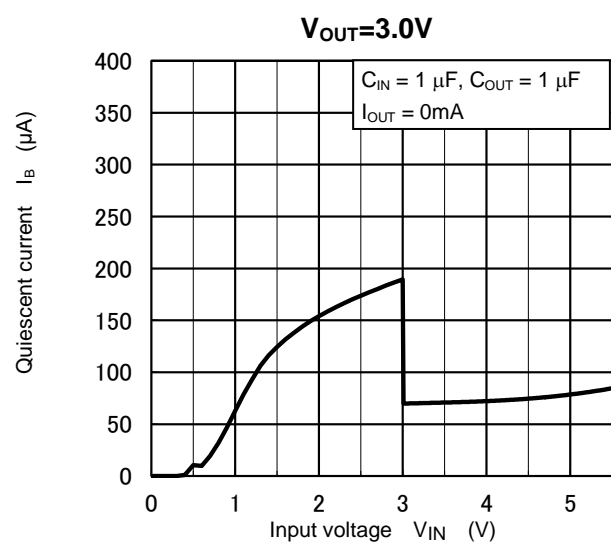
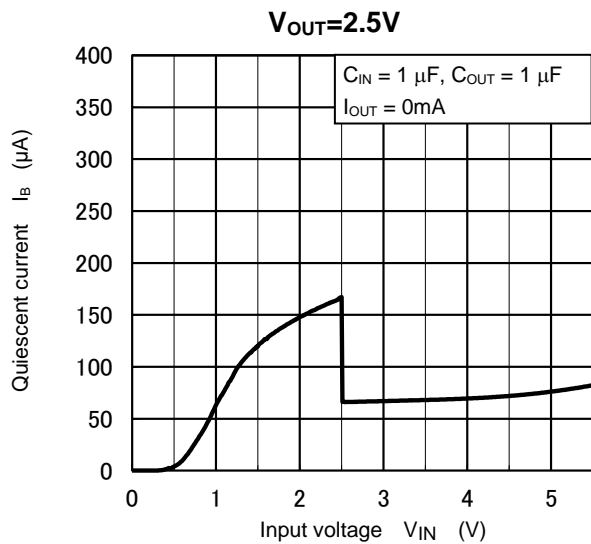
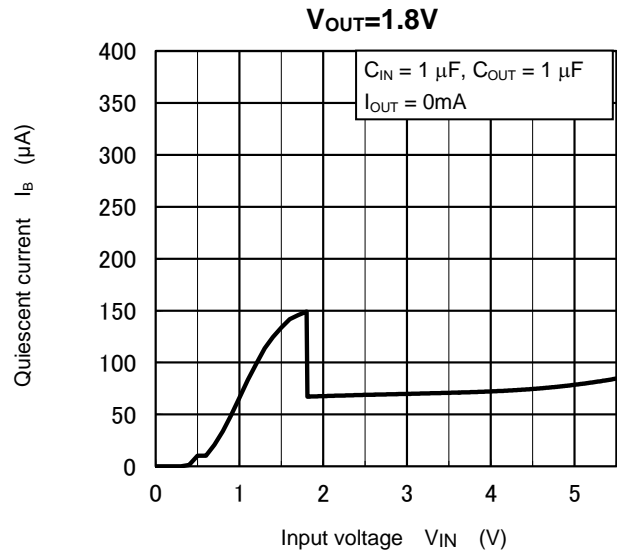
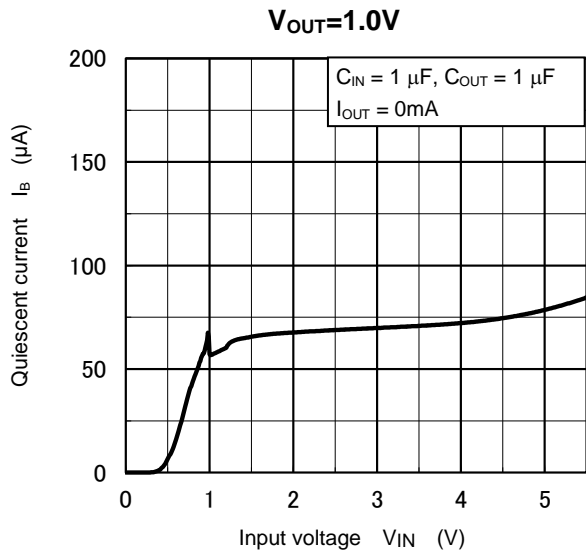

### Quiescent Current vs. Ambient Temperature

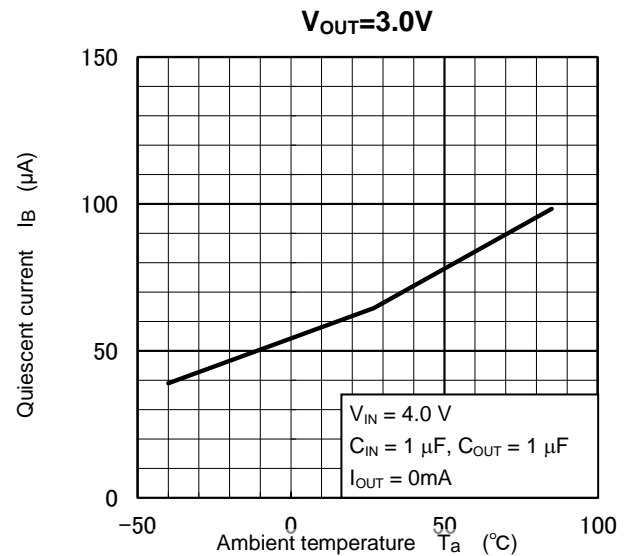
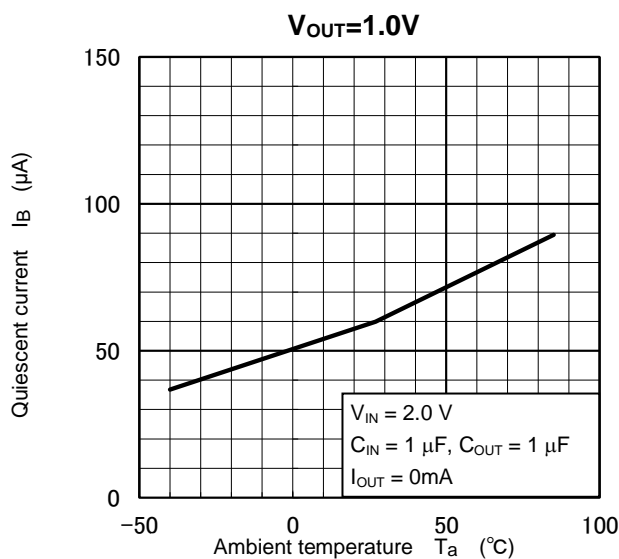

### Ripple Rejection Ratio vs. Frequency

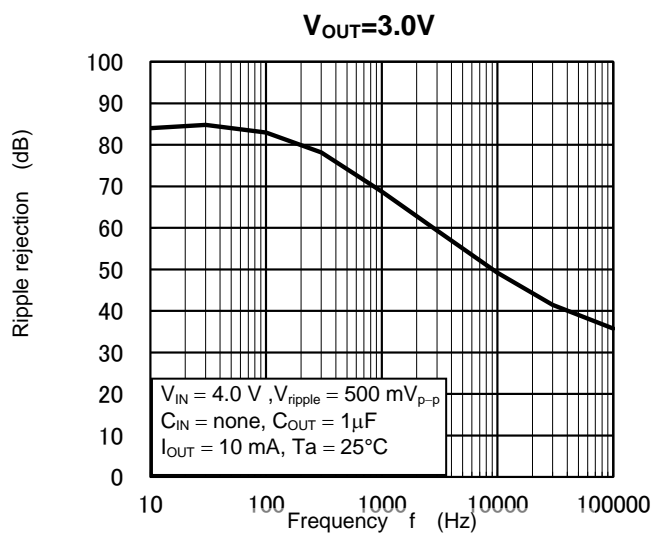
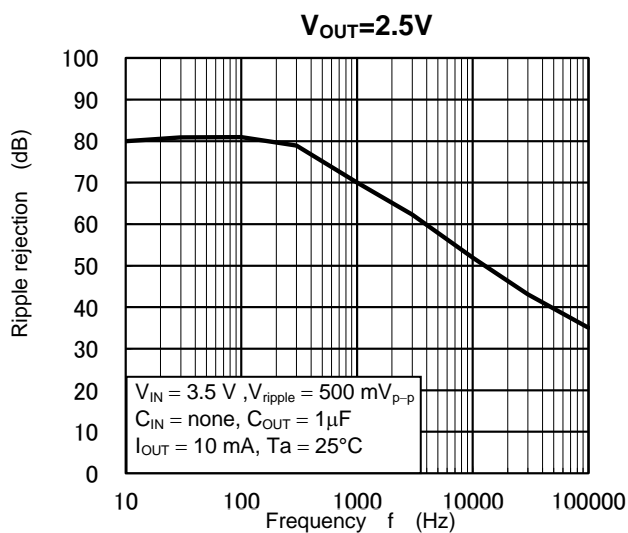
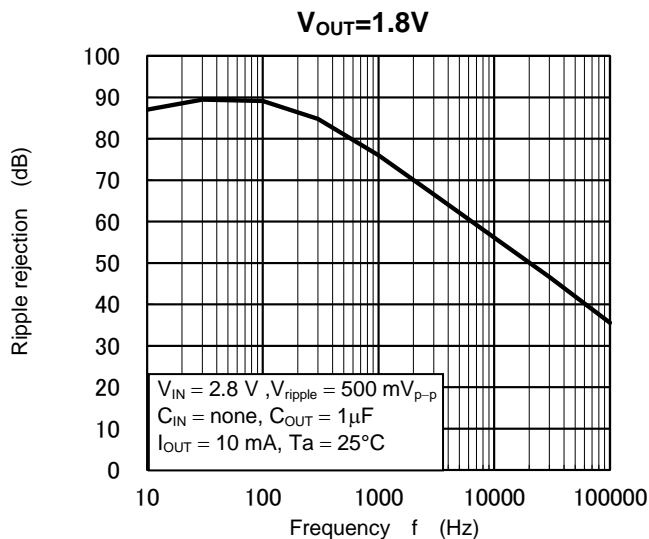
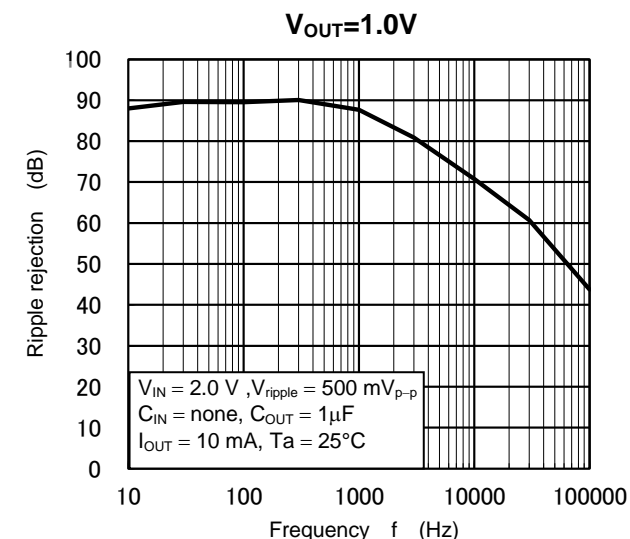

### Output Voltage vs. Output Current

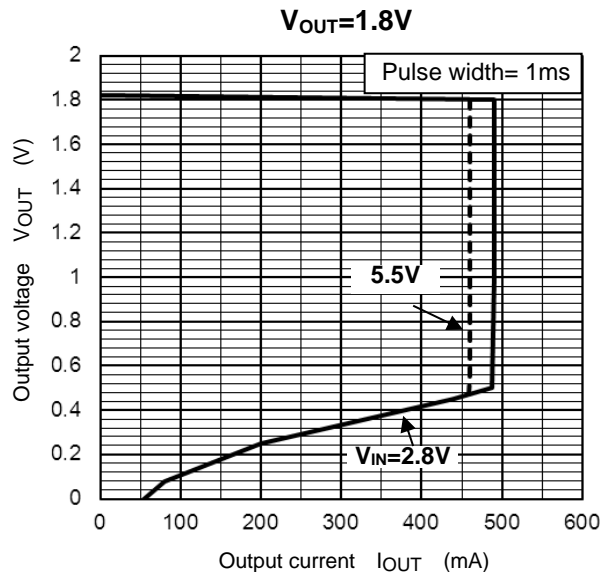
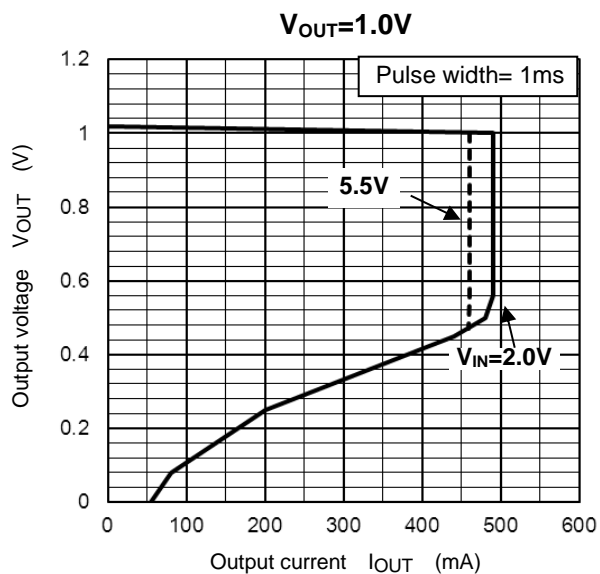

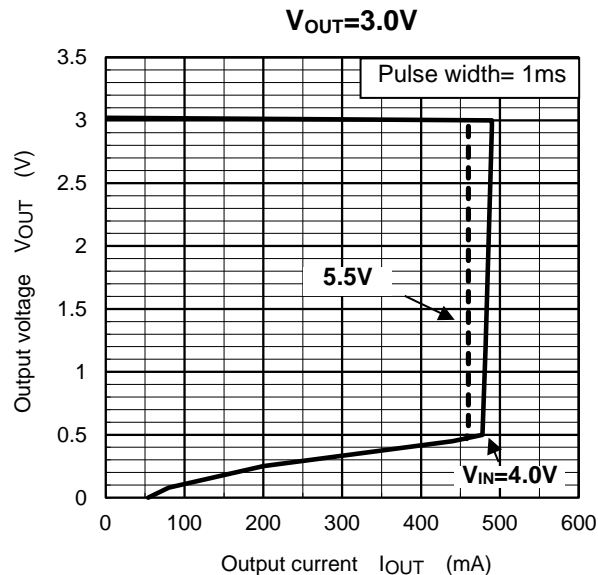
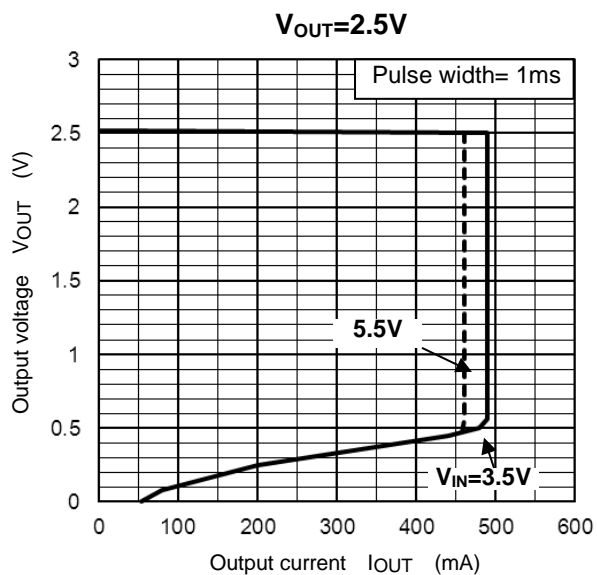

### Load Transient Response

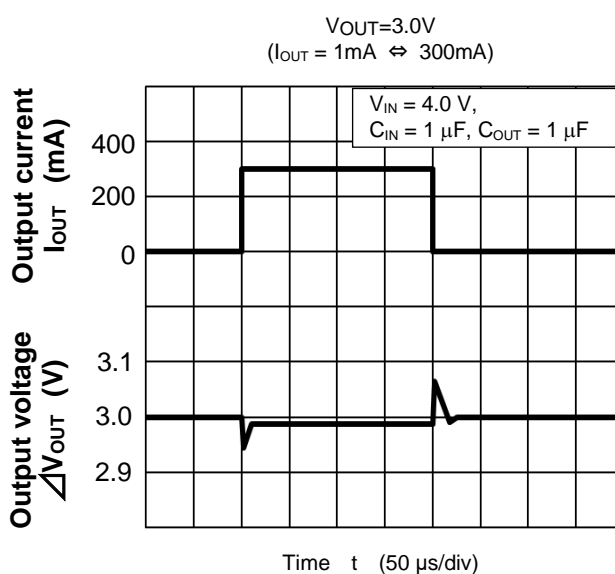
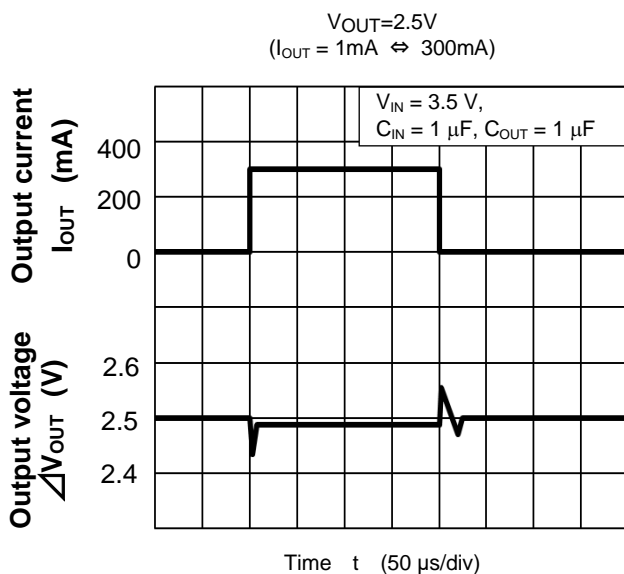
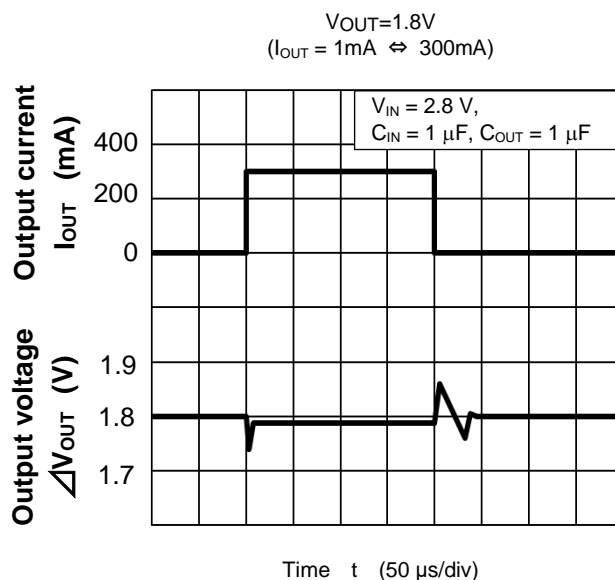
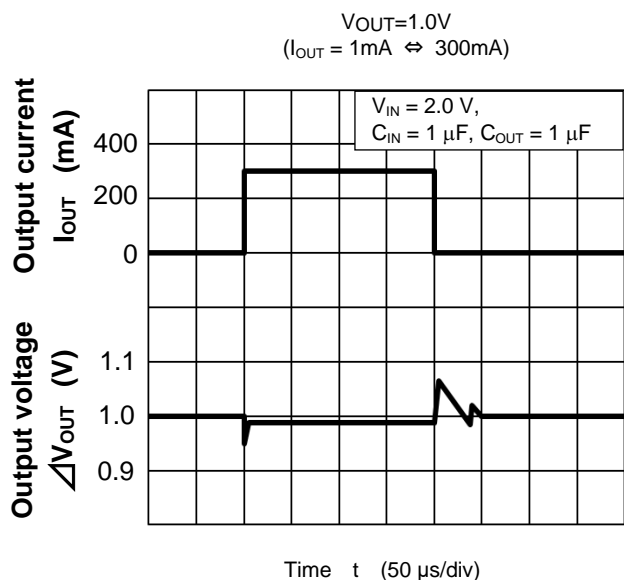

### $t_{ON}$ Response

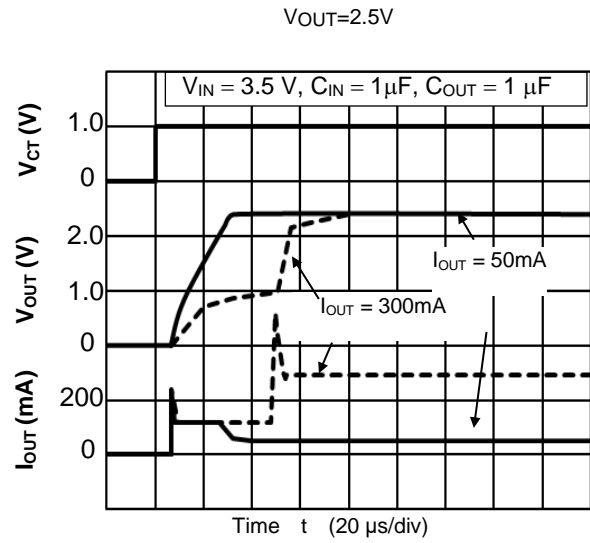
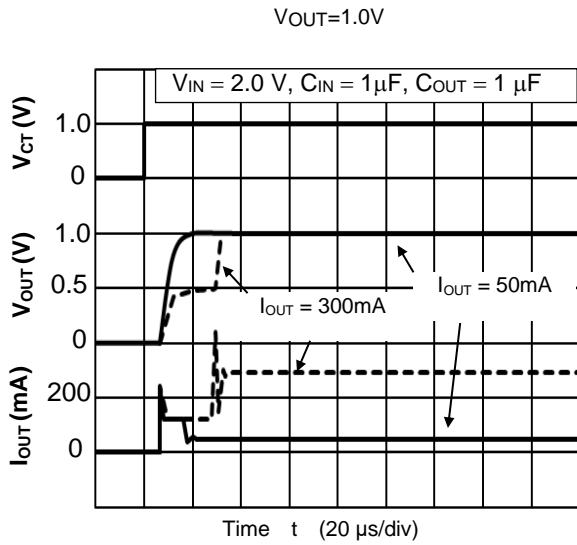

### $t_{OFF}$ Response

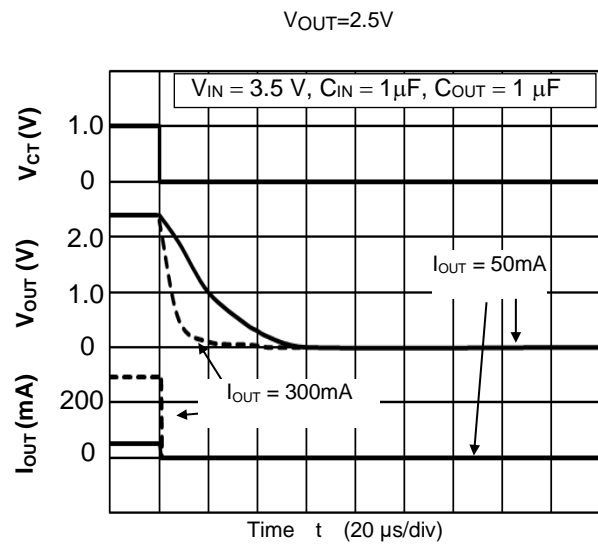
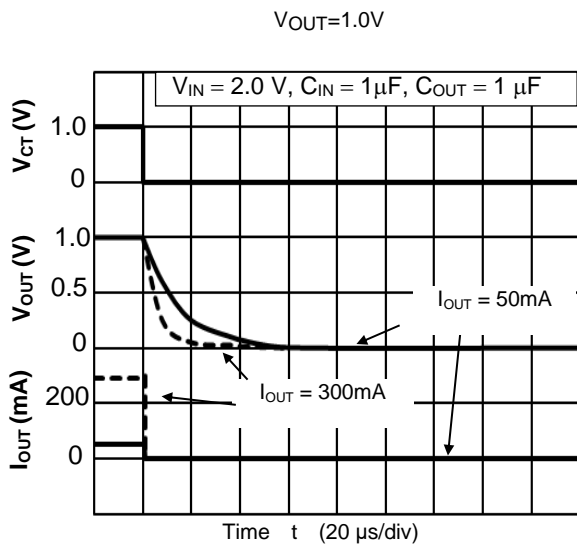

Note: The above characteristics curves are presented for reference only and not guaranteed by production test, unless otherwise noted.

## Package Information

SMV (SOT-25) (SC-74A)

Unit: mm

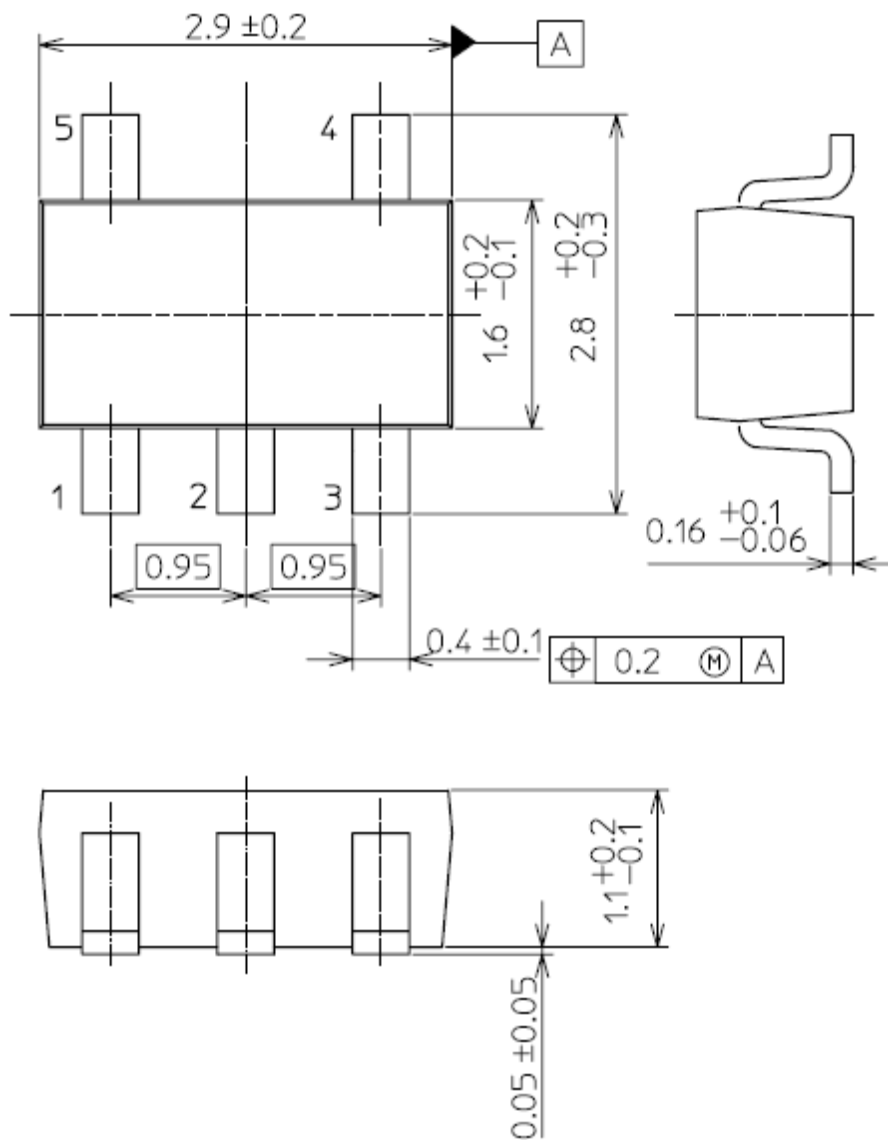

Weight: 16 mg (Typ.)

## RESTRICTIONS ON PRODUCT USE

Toshiba Corporation and its subsidiaries and affiliates are collectively referred to as "TOSHIBA". Hardware, software and systems described in this document are collectively referred to as "Product".

- This document and any information herein may not be reproduced without prior written permission from TOSHIBA. Even with TOSHIBA's written permission, reproduction is permissible only if reproduction is without alteration/omission.
- Though TOSHIBA works continually to improve Product's quality and reliability, Product can malfunction or fail. Customers are responsible for complying with safety standards and for providing adequate designs and safeguards for their hardware, software and systems which minimize risk and avoid situations in which a malfunction or failure of Product could cause loss of human life, bodily injury or damage to property, including data loss or corruption. Before customers use the Product, create designs including the Product, or incorporate the Product into their own applications, customers must also refer to and comply with (a) the latest versions of all relevant TOSHIBA information, including without limitation, this document, the specifications, the data sheets and application notes for Product and the precautions and conditions set forth in the "TOSHIBA Semiconductor Reliability Handbook" and (b) the instructions for the application with which the Product will be used with or for. Customers are solely responsible for all aspects of their own product design or applications, including but not limited to (a) determining the appropriateness of the use of this Product in such design or applications; (b) evaluating and determining the applicability of any information contained in this document, or in charts, diagrams, programs, algorithms, sample application circuits, or any other referenced documents; and (c) validating all operating parameters for such designs and applications. **TOSHIBA ASSUMES NO LIABILITY FOR CUSTOMERS' PRODUCT DESIGN OR APPLICATIONS.**
- **PRODUCT IS NEITHER INTENDED NOR WARRANTED FOR USE IN EQUIPMENTS OR SYSTEMS THAT REQUIRE EXTRAORDINARILY HIGH LEVELS OF QUALITY AND/OR RELIABILITY, AND/OR A MALFUNCTION OR FAILURE OF WHICH MAY CAUSE LOSS OF HUMAN LIFE, BODILY INJURY, SERIOUS PROPERTY DAMAGE AND/OR SERIOUS PUBLIC IMPACT ("UNINTENDED USE").** Except for specific applications as expressly stated in this document, Unintended Use includes, without limitation, equipment used in nuclear facilities, equipment used in the aerospace industry, lifesaving and/or life supporting medical equipment, equipment used for automobiles, trains, ships and other transportation, traffic signaling equipment, equipment used to control combustions or explosions, safety devices, elevators and escalators, and devices related to power plant. **IF YOU USE PRODUCT FOR UNINTENDED USE, TOSHIBA ASSUMES NO LIABILITY FOR PRODUCT.** For details, please contact your TOSHIBA sales representative or contact us via our website.
- Do not disassemble, analyze, reverse-engineer, alter, modify, translate or copy Product, whether in whole or in part.
- Product shall not be used for or incorporated into any products or systems whose manufacture, use, or sale is prohibited under any applicable laws or regulations.
- The information contained herein is presented only as guidance for Product use. No responsibility is assumed by TOSHIBA for any infringement of patents or any other intellectual property rights of third parties that may result from the use of Product. No license to any intellectual property right is granted by this document, whether express or implied, by estoppel or otherwise.
- **ABSENT A WRITTEN SIGNED AGREEMENT, EXCEPT AS PROVIDED IN THE RELEVANT TERMS AND CONDITIONS OF SALE FOR PRODUCT, AND TO THE MAXIMUM EXTENT ALLOWABLE BY LAW, TOSHIBA (1) ASSUMES NO LIABILITY WHATSOEVER, INCLUDING WITHOUT LIMITATION, INDIRECT, CONSEQUENTIAL, SPECIAL, OR INCIDENTAL DAMAGES OR LOSS, INCLUDING WITHOUT LIMITATION, LOSS OF PROFITS, LOSS OF OPPORTUNITIES, BUSINESS INTERRUPTION AND LOSS OF DATA, AND (2) DISCLAIMS ANY AND ALL EXPRESS OR IMPLIED WARRANTIES AND CONDITIONS RELATED TO SALE, USE OF PRODUCT, OR INFORMATION, INCLUDING WARRANTIES OR CONDITIONS OF MERCHANTABILITY, FITNESS FOR A PARTICULAR PURPOSE, ACCURACY OF INFORMATION, OR NONINFRINGEMENT.**
- Do not use or otherwise make available Product or related software or technology for any military purposes, including without limitation, for the design, development, use, stockpiling or manufacturing of nuclear, chemical, or biological weapons or missile technology products (mass destruction weapons). Product and related software and technology may be controlled under the applicable export laws and regulations including, without limitation, the Japanese Foreign Exchange and Foreign Trade Law and the U.S. Export Administration Regulations. Export and re-export of Product or related software or technology are strictly prohibited except in compliance with all applicable export laws and regulations.
- Please contact your TOSHIBA sales representative for details as to environmental matters such as the RoHS compatibility of Product. Please use Product in compliance with all applicable laws and regulations that regulate the inclusion or use of controlled substances, including without limitation, the EU RoHS Directive. **TOSHIBA ASSUMES NO LIABILITY FOR DAMAGES OR LOSSES OCCURRING AS A RESULT OF NONCOMPLIANCE WITH APPLICABLE LAWS AND REGULATIONS.**