



# TCKE8xx Series Evaluation Board Instruction Manual

## Safety Precautions



This section lists important precautions which users of our product(s) (and anyone else) should observe in order to avoid injury to human body and damage to property, and to ensure safe and correct use of our products. Please be sure that you understand the meanings of the labels and graphic symbols described below before you move on to the detailed descriptions of the precautions, and comply with the precautions stated.



### Explanation of Labels

 <b>DANGER</b>	 <b>WARNING</b>	 <b>CAUTION</b>	<b>NOTICE</b>
Indicates a hazardous situation which, if not avoided, will result in death or serious injury <sup>1</sup> .	Indicates a hazardous situation which, if not avoided, could result in death or serious injury <sup>1</sup> .	Indicates a potentially hazardous situation which, if not avoided, may result in minor or moderate injury <sup>2</sup> .	Indicates practices that may cause property damage <sup>3</sup> and other problems, but not personal injury

1. Serious injury includes blindness, wounds, burns (low and high temperature), electric shock, fractures, and poisoning, etc. with long-lasting effects or that require hospitalization and/or long-term hospital visits for treatment.
2. Minor or moderate injury includes wounds, burns, electric shock, etc. not requiring hospitalization and/or long-term hospital visits for treatment.
3. Property damage means damage to customer or third party machines and equipment.

### Explanation of Graphic Symbols

 <b>Prohibited</b>	 <b>Instructions</b>
Indicates prohibited actions.	Indicates actions that must be undertaken for safety purposes.

 <b>CAUTION</b>	
 <b>Prohibited</b>	Do not touch the circuit boards or components while the power is on. Doing so may cause electric shock or heat, resulting in burns.
 <b>Instructions</b>	Be careful of sharp parts such as terminals. Failure to do so may cause personal injury.

**This is a reference material. Do not design the final equipment in this document.**

### 1. Introduction

TCKE8xx Evaluation Board (EVB) is an evaluation board for supporting TCKE8xx series-design. The passive components required to operate IC are mounted, enabling easy operation check and characterization. The specifications and absolute maximum ratings of the target product are described in the data sheet. Refer to this together with the user guide.

Table 1-1 TCKE8 Series Lineup

Evaluation Board name	Product name	Input Voltage range	Output limit Current range	OVC OVP	Slew Rate	Enable Control	Return operation	Auto Discharge	Package
EVB-TCKE800NA*	TCKE800NA	4.4V~18V	0.5A~5.0A adjustable	None	Adjustable	Active High	Auto retry	Yes	WSON10B 3x3mm
EVB-TCKE800NL*	TCKE800NL						Latch		
EVB-TCKE805NA	TCKE805NA			6.04V OVC			Auto retry		
EVB-TCKE805NL*	TCKE805NL			Latch					
EVB-TCKE812NA*	TCKE812NA			15.1V OVC			Auto retry		
EVB-TCKE812NL*	TCKE812NL			Latch					

\*Under development

Table 1-2 Evaluation board characteristics

Item	Description
Size	46mm x 66 mm
Material	Glass Epoxy (FR-4)

Table 1-3 Bundled items

Item	Description
Instruction manual	Describes the precautions and circuit configuration of the evaluation board (this document)
Evaluation Board	Evaluation board for e-Fuse IC (TCKE8xx series)

#### Precautions for use

- After careful consideration of the input voltage, output voltage, output current, temperature, capacitor, inductor, and resistance types and characteristics, confirm the actual operation of the product when selecting the component.
- The product described as a peripheral part of this product shows a typical use example, and it may become impossible to supply. Check the latest information before use.

This is a reference material. Do not design the final equipment in this document.

### 2. Schematic and BOM list

Figure 2-1 shows EVB schematics and Table 2-1 BOM list. For how to connect EVB, see chapter 3 SET UP.

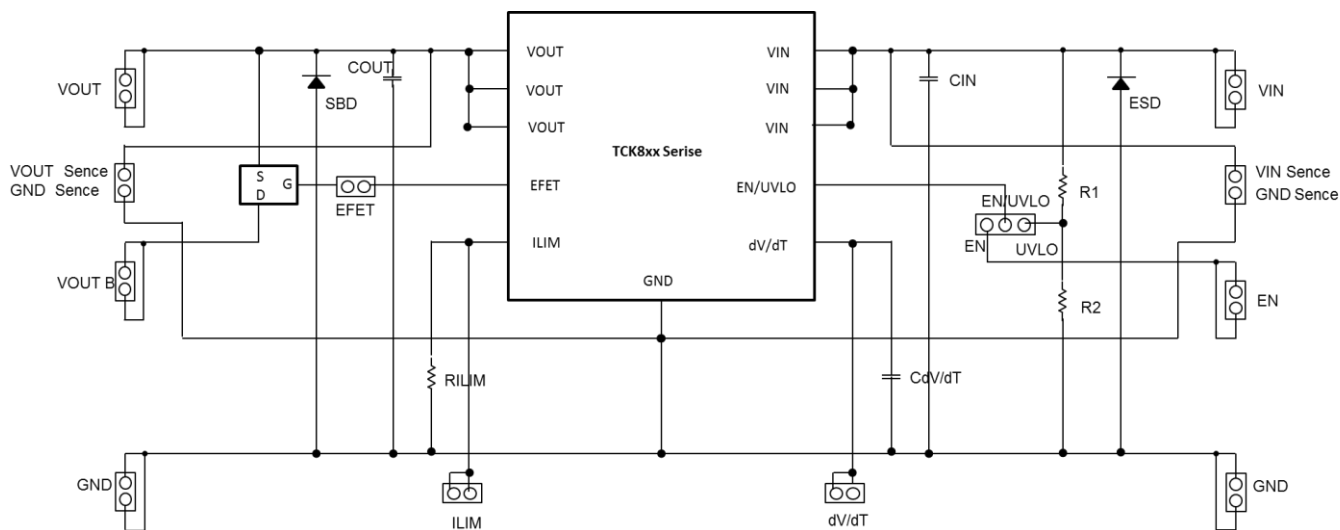

Figure 2-1 TCKE8xx EVB Schematic

Table 2-1 BOM list

Part symbol	Product name	Package	Number	Details
U1	TCKE8 series	WSON10B	1	eFuse IC
FET1	-	-	OPEN	Nch-MOSFET (for reverse-current protection: optional)
C1(CIN)	-	-	1	Capacitor 1 $\mu$ F
C2(COUT)	-	-	1	Capacitor 1 $\mu$ F
C3 (CdVdt)	-	-	1	Capacitor 120pF
R1	-	-	OPEN	UVLO setting
R2	-	-	OPEN	UVLO setting
R5 (RILIM)	-	-	1	Resistor 35.7k $\Omega$ (ILIM $\approx$ 2.98A)
SBD	CUHS20S30	US2H	1	VF=0.34V/30V/2A
ESD protection	DF2S23P2CTC	CST2C	1	VRWM $\leq$ 21 V

This is a reference material. Do not design the final equipment in this document.

### 3. How to set up

This chapter describes how to set up and connect jumpers. Please refer to the data sheet and application notes of this product for the test conditions.

#### INPUT (VIN)

VIN terminal is connected to the positive of the power supply. Connect the positive terminal to VIN. (Connect Ground (grounding) of the power supply side to the lower GND of VIN terminal).

#### OUTPUT (VOUT)

VOUT terminal is EVB output terminal. Connect the positive terminal of the load to VOUT terminal (connect Ground (grounding) on the load side to the lower GND terminal of VOUT terminal).

#### OUTPUT (VOUT B)

VOUT B terminal is used when a MOSFET for reverse-current protection (RCB) is used. The gate-voltage to drive MOS is supplied from EFET terminal described below.

#### VIN sense, GND sense, and VOUT sense and GND sense

These four terminals are used to accurately measure VIN or VOUT voltage by correcting the drop voltage caused by the parasitic resistor of EVB. For example, when measuring the on-resistance between VIN-VOUT terminals, measure the potential difference between VIN sense-VOUT sense terminals to calculate Ron unaffected by the parasitic resistance

#### EN/UVLO

EN/UVLO pin selects EN (enable) and UVLO functions. During normal operation, the center and left (EN) terminals are connected for use. To use UVLO function, connect the center and the right (UVLO) terminal.

#### EFET

EFET is a terminal to be connected when RCB function is used. The right terminal of EFET symbol is connected to EFET of the device. The left terminal of EFET notation (silk characters) is connected to MOSFET gating terminal (in the default status, OPEN status because MOSFET is not installed). By mounting MOSFET (mounting it later), it is possible to check RCB(Reverse Current Block) function.

#### dV/dT

dV/dT pin is used to adjust the rise time.

The rise-time is adjusted by the capacitance between dV/dT terminal and GND pin. Normally, 1nF and max. 100nF are available.

#### ILIM

ILIM terminal is used to adjust the overcurrent limit.

Adjust the overcurrent limit using a resistor ( $R_{ILIM}$ ) between ILIM and GND terminals.

$R_{ILIM}$  can range from 20k $\Omega$  to 300k $\Omega$ .

This is a reference material. Do not design the final equipment in this document.

### 4. Appearance of evaluation board

This chapter provides an exterior view of TCKE8xx series EVB.

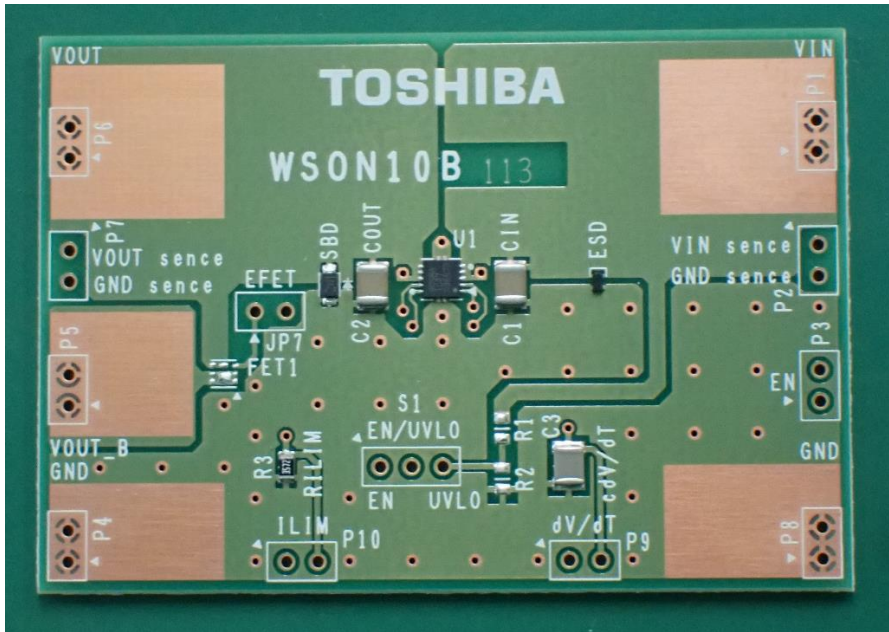

Figure 5-1 Front side

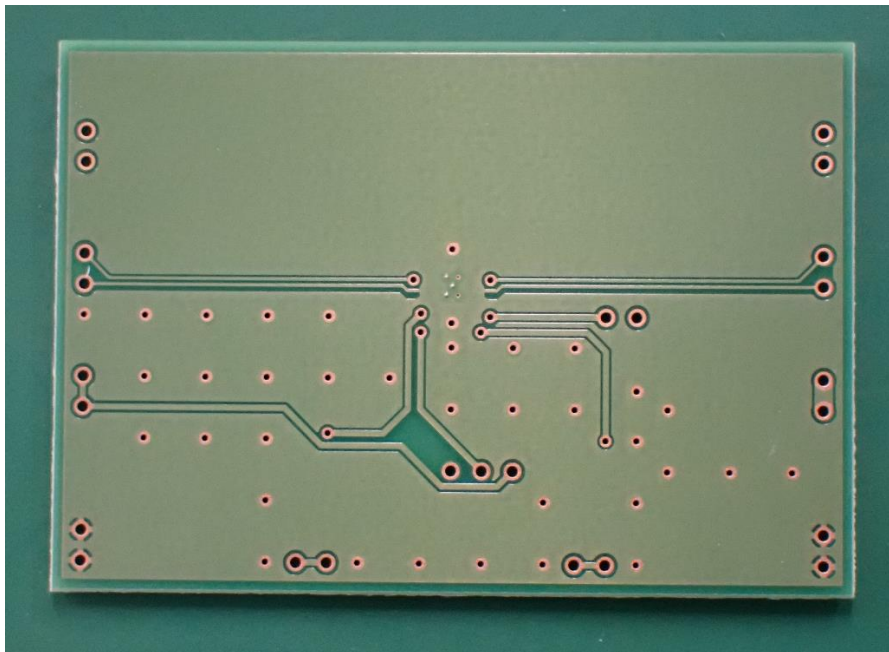

Figure 5-2 Back side

#### PCB layout guidelines

- Keep all wiring as short as possible to minimize the effects of parasitic components.
- Install CIN and COUT as close to IC as possible to obtain a stable power supply.
- Wider VIN, VOUT, GND wires can reduce the effects of thermal impedances and parasitic components.
- By separating the small-signal GND from the power GND, the effect of noises caused by the return current can be reduced.

This is a reference material. Do not design the final equipment in this document.

## **Assessment board warranty provisions**

This regulation is intended for the warranty of the evaluation board of TOSHIBA CORPORATION DEVICE & STORAGE CORPORATION ("MHI"). Quality control and specifications are stipulated to ensure safe use of our evaluation board. Be sure to follow the usage conditions.

### Article 1 (Contents of Warranty)

We replace with equivalent new products free of charge if any trouble is caused by manufacturing defects under the normal use conditions described in the Evaluation Board User's Guide, user's Guidelines, technical documents or product documentation published on our Web site, delivery specifications, product documentation, attached labeling, and other notices and similar explanatory documents (hereinafter referred to as "product manuals/documents" or provided by us and our customers, regardless of how to provide them) on our Web site. The judgment of manufacturing defects shall be at our discretion.

### Article 2 (Warranty Period)

The acceptance period for free replacement shall be 30 days from the date of shipment of such products by the Distributor.

### Article 3 (Reasons for Non-application of Warranty)

Even within the warranty period, failure, damage, or damage due to any of the following causes will not be covered by the warranty.

1. Use contrary to the contents of product manuals and documents
2. When the upper limit of the number of times the flash memory is written is reached, it is caused by wear of the hardware itself, such as the life due to the charge/discharge characteristics of the capacitor or the rechargeable battery.
3. Deterioration that occurred during use of the evaluation board, including discoloration, abrasion, abrasion, dents, disconnection, and corrosion (except for initial defects at delivery)
4. Dust, dirt, sand, insects, and other foreign matter mixed in after delivery from us
5. Due to salt damage
6. Processing, repair, modification, disassemble, or replacement of parts by anyone other than us
7. Due to transportation or dropping after delivery
8. Fire, earthquake, flood, lightning, other natural disasters, pollution, abnormal voltage, and other external factors or unexpected accidents
9. Caused by connecting other equipment or parts (excluding optional items specified by us)
10. Problems caused by software
11. Unknown or unintended use or use
12. If any direct or indirect cause of the failure or damage other than the above is recognized to be caused by the user's use method

### Article 4 (Surface Mount after Delivery)

In principle, the product will not be covered by warranty if any processing other than lead component mounting is performed after it is delivered from us.

**This is a reference material. Do not design the final equipment in this document.**

**Article 5 (Acceptance of Replacement)**

Replacement in accordance with these regulations shall be performed using the send-back method.

Customer shall promptly submit an application for replacement at the Distributor's contact point to the contact point instructed by the Distributor. Packaging for equipment set-up and transport at the customer's location shall not be included in service in accordance with this regulation. In addition, the shipping fees at the time of shipment shall be borne by each shipping source, except when the customer and us agree beforehand with each other on a written basis. We assume that you will ship the defective product in the same hardware configuration (including the accessories for the set product) as when it was delivered from us. We take no responsibility for the storage and maintenance of customer-owned connectors, cables and other parts and fixtures incorporated into or connected to malfunction items, and any software or data written on faulty items.

**Article 6 (Composition of Replacement Products)**

If replacements are made under this regulation, we will provide replacement products with the same hardware configuration as the one at the time that the faulty product was delivered from us (our product number or equivalent to our product). If inventory of the same model number is not already present at us, such as when the product in question has been upgraded, we will provide the customer with the equivalent specification or upwardly compatible product as a replacement product. For the main body of the replacement product, the latest version of the image data provided by us at the time of manufacture of the replacement stock shall be written.

**Article 7 (Handling of defective products)**

Ownership of the defective product after replacement shall be attributed to us, and it shall not be returned to the customer but be stored or disposed of by us.

**Article 8 (Disclaimer)**

The warranty made by us with respect to the Tests shall be limited to replacement performed in accordance with Articles 1, 5 and 6, and in no event shall we be liable for indirect damages (loss of business profit, interruption of business, loss of business information, etc.), extraordinary damages, incidental damages, expansion damages, loss or damage to data for other equipment or parts, damages based on claims from third parties and damages to other property, regardless of the type of legal claim. Please note that this guarantee regulations are subject to change without prior notice.

**This is a reference material. Do not design the final equipment in this document.**

## Warnings, Limitations, and Disclaimer for Evaluation Boards

Unless otherwise specified, this evaluation board is not intended for use by general consumers, not the finished final product. It is intended only for preliminary feasibility assessment in a laboratory/development environment by technical and electronics experts familiar with the hazards and application risks associated with the handling of electromechanical parts, systems and subsystems. It is not intended to be used in whole or in part of the final product.

The Buyer of this Evaluation Board acknowledges, expresses and considers to have agreed to the following at the stage when the Evaluation Board is put into service:

1. The purchaser of the Evaluation Board has a unique knowledge of national regulatory requirements in relation to the final product and in relation to the use of the Evaluation Board for evaluation, testing and other purposes (and/or the use of the purchaser's affiliates, affiliates, contractors or designees).
2. The purchaser of the Evaluation Board is fully and exclusively responsible for ensuring that the safety of the final product and compliance with all such laws and other applicable regulatory requirements are complied with and that the purchaser of the Evaluation Board is fully and exclusively responsible for ensuring the safety of the activities performed by its employees, affiliates, contractors or designees using the Evaluation Board. In addition, it is the responsibility to ensure that any contact (electronic and/or mechanical) between the Evaluation Board and the human body has been designed with adequate insulation and means to safely limit the potential leakage currents in order to minimize the risk of electrical shock.
3. Since the assessment board is not a completed product, it may not usually meet all applicable regulatory and safety compliance standards (e.g. UL, CSA, VDE, CE, RoHS, WEEE) that may be relevant for similar items. Buyer of this evaluation board is responsible for determining and/or guaranteeing compliance with applicable standards and related certificates. The purchaser of this evaluation board will take reasonable safeguards to ensure that the use of the evaluation board does not result in property damage, injury or death even if the evaluation board does not perform as described or expected.
4. We will endeavor to properly dispose of and recycle the electronic components and packaging materials of our evaluation boards.

It is important that this evaluation board be operated according to the user guidelines within the recommended specifications and environmentally friendliness presented by Toshiba Devices & Storage Corporation. Exceeding the specified evaluation board ratings (including but not limited to input and output voltages, currents, power, and environmental ranges) may cause property damage, personal injury, or death. Loads applied outside the specified output range can result in unintended and/or unstable operation and/or permanent damage to the evaluation board and/or peripheral electronics. Refer to the user guidelines before connecting the load to the evaluation board output. During normal operation, the case temperature of some circuit components may exceed 60°C, even if the input and output are maintained at a normal ambient operating temperature. These components include, but are not limited to, linear regulators, switching transistors, pass transistors, and current sense resistors. They can be identified using the schematics given in the user guidelines. Note that when measuring probes are placed close to these instruments, these instruments may become very hot when touched. As with all measuring instruments, only qualified personnel familiar with electronic measurements and diagnostics normally found in development environments should use these evaluation boards.

**This is a reference material. Do not design the final equipment in this document.**



The Purchaser of the Evaluation Board agrees to defend, indemnify and hold TOSHIBA CORPORATION Devices & Storage Corporation, its licensors and their representatives harmless from and against any and all claims, damages, losses, expenses, costs and liabilities (collectively, the "Claims") arising out of or related to the use of the Evaluation Board which do not comply with this Warning, Limitation and Disclaimer. This obligation shall apply whether or not the Claim arises under tort law, contract or other legal theory and even if the Evaluation Board fails to function as stated or anticipated.

If a failure of TOSHIBA CORPORATION Devices & Storage Corporation's products is to be evaluated for a part that is reasonably expected to cause serious personal injury or death and is usable for a safety-critical application (i.e., devices related to nuclear energy, aviation and space equipment, medical devices (excluding health care), in-vehicle and transportation equipment, trains, ships, traffic lights, combustion and explosion control devices, safety devices, elevators and escalators, and power generation devices), it must be specifically notified to Toshiba Devices & Storage Corporation that fact and a separate warranty and compensation agreement must be concluded.

**This is a reference material. Do not design the final equipment in this document.**

## RESTRICTIONS ON PRODUCT USE

Toshiba Corporation and its subsidiaries and affiliates are collectively referred to as "TOSHIBA". Hardware, software and systems described in this document are collectively referred to as "Product".

- TOSHIBA reserves the right to make changes to the information in this document and related Product without notice.
- This document and any information herein may not be reproduced without prior written permission from TOSHIBA. Even with TOSHIBA's written permission, reproduction is permissible only if reproduction is without alteration/omission.
- Though TOSHIBA works continually to improve Product's quality and reliability, Product can malfunction or fail. Use the Product in a way which minimizes risk and avoid situations in which a malfunction or failure of Product could cause loss of human life, bodily injury or damage to property, including data loss or corruption. For using the Product, customers must also refer to and comply with the latest versions of all relevant TOSHIBA information, including without limitation, this document, the instruction manual, the specifications, the data sheets for Product.
- Product is provided solely for the purpose of performing the functional evaluation of a semiconductor product. Please do not use Product for any other purpose, including without limitation, evaluation in high or low temperature or humidity, and verification of reliability.
- Do not incorporate Product into your products or system. Products are for your own use and not for sale, lease or other transfer.
- Do not disassemble, analyze, reverse-engineer, alter, modify, translate or copy Product, whether in whole or in part.
- Product shall not be used for or incorporated into any products or systems whose manufacture, use, or sale is prohibited under any applicable laws or regulations.
- The information contained herein is presented only as guidance for Product use. No responsibility is assumed by TOSHIBA for any infringement of patents or any other intellectual property rights of third parties that may result from the use of Product. No license to any intellectual property right is granted by this document, whether express or implied, by estoppel or otherwise.
- **ABSENT A WRITTEN SIGNED AGREEMENT, EXCEPT AS PROVIDED IN THE RELEVANT TERMS AND CONDITIONS OF SALE FOR PRODUCT, AND TO THE MAXIMUM EXTENT ALLOWABLE BY LAW, TOSHIBA (1) ASSUMES NO LIABILITY WHATSOEVER, INCLUDING WITHOUT LIMITATION, INDIRECT, CONSEQUENTIAL, SPECIAL, OR INCIDENTAL DAMAGES OR LOSS, INCLUDING WITHOUT LIMITATION, LOSS OF PROFITS, LOSS OF OPPORTUNITIES, BUSINESS INTERRUPTION AND LOSS OF DATA, AND (2) DISCLAIMS ANY AND ALL EXPRESS OR IMPLIED WARRANTIES AND CONDITIONS RELATED TO SALE, USE OF PRODUCT, OR INFORMATION, INCLUDING WARRANTIES OR CONDITIONS OF MERCHANTABILITY, FITNESS FOR A PARTICULAR PURPOSE, ACCURACY OF INFORMATION, OR NONINFRINGEMENT.**
- Do not use or otherwise make available Product or related software or technology for any military purposes, including without limitation, for the design, development, use, stockpiling or manufacturing of nuclear, chemical, or biological weapons or missile technology products (mass destruction weapons). Product and related software and technology may be controlled under the applicable export laws and regulations including, without limitation, the Japanese Foreign Exchange and Foreign Trade Law and the U.S. Export Administration Regulations. Export and re-export of Product or related software or technology are strictly prohibited except in compliance with all applicable export laws and regulations.
- Please contact your TOSHIBA sales representative for details as to environmental matters such as the RoHS compatibility of Product. Please use Product in compliance with all applicable laws and regulations that regulate the inclusion or use of controlled substances, including without limitation, the EU RoHS Directive. **TOSHIBA ASSUMES NO LIABILITY FOR DAMAGES OR LOSSES OCCURRING AS A RESULT OF NONCOMPLIANCE WITH APPLICABLE LAWS AND REGULATIONS.**

---

## Toshiba Electronic Devices & Storage Corporation

<https://toshiba.semicon-storage.com/>