

Zener Diode Silicon Epitaxial Planar

MUZ series

1. Applications

- (1) Voltage surge protection

2. Features

- (1) Small package
- (2) The typical voltage of VZ is accorded to E24 series.

3. Packaging and Internal Circuit

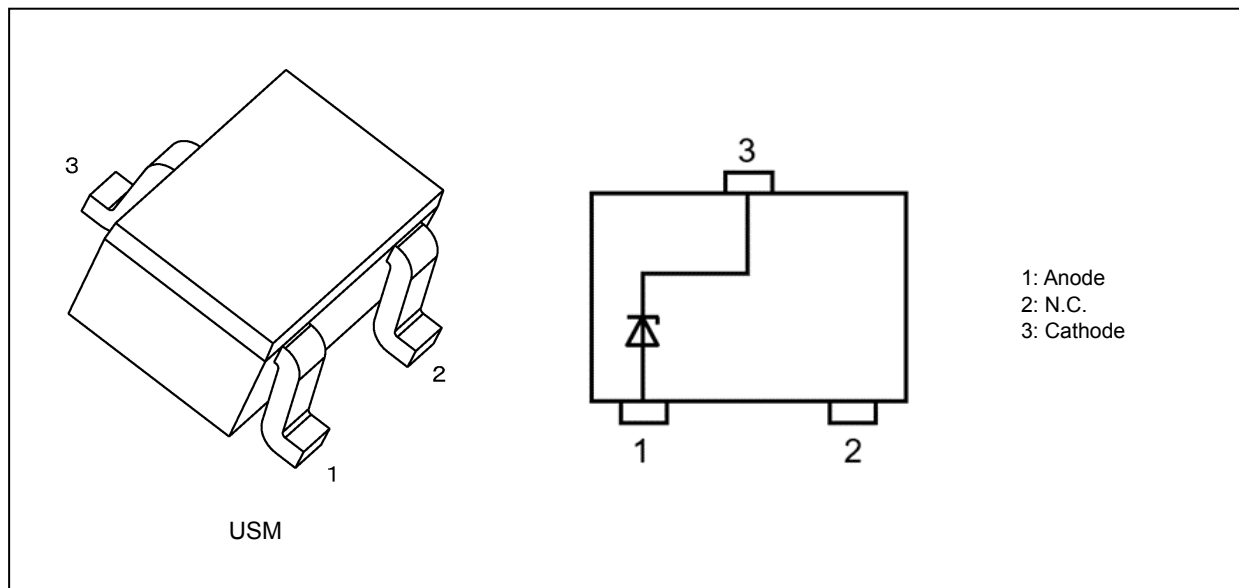

4. Absolute Maximum Ratings 1 (Note) (Unless otherwise specified, $T_a = 25\text{ }^\circ\text{C}$)

Characteristics	Symbol	Note	Rating	Unit
Power dissipation	P_D	(Note 1)	150	mW
		(Note 2)	600	
Junction temperature	T_j		150	$^\circ\text{C}$
Storage temperature	T_{stg}		-55 to 150	

Note: Using continuously under heavy loads (e.g. the application of high temperature/current/voltage and the significant change in temperature, etc.) may cause this product to decrease in the reliability significantly even if the operating conditions (i.e. operating temperature/current/voltage, etc.) are within the absolute maximum ratings.

Please design the appropriate reliability upon reviewing the Toshiba Semiconductor Reliability Handbook ("Handling Precautions"/"Derating Concept and Methods") and individual reliability data (i.e. reliability test report and estimated failure rate, etc).

Note 1: Mounted on a glass epoxy circuit board of 25.4 mm × 25.4 mm × 1.6 mm, Cu pad: 0.42 mm² × 3

Note 2: Mounted on a glass epoxy circuit board of 25.4 mm × 25.4 mm × 1.6 mm, Cu pad: 645 mm²

Start of commercial production

2020-07

5. Absolute Maximum Ratings 2 (Note) (Unless otherwise specified, T_a = 25 °C)

Type No.	Electrostatic discharge voltage (Contact, Air) V _{ESD} (kV) (Note 1)	Peak pulse power P _{PK} (W) (Note 2)	Peak pulse current I _{PP} (A) (Note 2)
MUZ5V6	±30	155	12.0
MUZ6V2	±30	175	11.0
MUZ6V8	±30	180	10.0
MUZ7V5	±30	190	9.5
MUZ8V2	±30	200	8.5
MUZ9V1	±30	200	8.0
MUZ10V	±30	200	7.5
MUZ11V	±30	200	7.25
MUZ12V	±30	200	7.0
MUZ13V	±30	200	6.5
MUZ15V	±30	200	5.6
MUZ16V	±30	200	5.5
MUZ18V	±30	200	5.1
MUZ20V	±30	200	5.0
MUZ22V	±30	200	4.75
MUZ24V	±30	200	4.5
MUZ27V	±20	200	4.1
MUZ30V	±20	200	4.0
MUZ33V	±17	200	3.5
MUZ36V	±12	200	3.0

Note: Using continuously under heavy loads (e.g. the application of high temperature/current/voltage and the significant change in temperature, etc.) may cause this product to decrease in the reliability significantly even if the operating conditions (i.e. operating temperature/current/voltage, etc.) are within the absolute maximum ratings.

Please design the appropriate reliability upon reviewing the Toshiba Semiconductor Reliability Handbook ("Handling Precautions"/"Derating Concept and Methods") and individual reliability data (i.e. reliability test report and estimated failure rate, etc).

Note1: According to IEC61000-4-2.

Note2: according to IEC61000-4-5 (t_p = 8 / 20 μs)

6. Electrical Characteristics (Unless otherwise specified, $T_a = 25\text{ }^\circ\text{C}$)

Type No.	Zener Voltage V_Z (V)				Dynamic Impedance Z_Z (Ω)		Dynamic Resistance R_{DYN} (Ω) (Note 1)	Clamp Voltage V_C (V) (Note 1) (Note 2)	Total Capacitance C_T (pF) (Note 3)	Reverse Current I_R (μA)	
	Min	Typ.	Max	Test Current I_Z (mA)	Max	Test Current I_Z (mA)	Typ.	Typ.	Typ.	Max	Test Voltage V_R (V)
MUZ5V6	5.3	5.6	6.0	5	30	5	0.16	9.0	125	1	3.5
MUZ6V2	5.8	6.2	6.6	5	30	5	0.21	10.0	105	2.5	5.0
MUZ6V8	6.4	6.8	7.2	5	30	5	0.27	13.0	88	1.5	5.5
MUZ7V5	7.0	7.5	7.9	5	30	5	0.32	14.0	78	0.1	6.0
MUZ8V2	7.7	8.2	8.7	5	30	5	0.37	16.5	67	0.1	7.0
MUZ9V1	8.5	9.1	9.6	5	30	5	0.44	17.0	62	0.1	7.5
MUZ10V	9.4	10.0	10.6	5	30	5	0.52	19.0	60	0.1	8.0
MUZ11V	10.4	11.0	11.6	5	30	5	0.60	24.0	48	0.1	9.0
MUZ12V	11.4	12.0	12.6	5	30	5	0.70	26.0	44	0.1	10.0
MUZ13V	12.4	13.0	14.1	5	30	5	0.80	27.0	42	0.1	11.0
MUZ15V	13.8	15.0	15.6	5	30	5	0.60	24.0	36	0.1	12.0
MUZ16V	15.3	16.0	17.1	5	35	5	0.50	27.0	35	0.1	14.0
MUZ18V	16.8	18.0	19.1	5	45	5	0.40	28.5	31	0.1	16.0
MUZ20V	18.8	20.0	21.2	5	70	5	0.35	30.5	29	0.1	17.6
MUZ22V	20.8	22.0	23.3	5	70	5	0.40	32.0	27	0.1	18.0
MUZ24V	22.8	24.0	25.6	5	70	5	0.60	36.5	26	0.1	19.0
MUZ27V	25.1	27.0	28.9	2	70	2	0.90	45.0	23	0.1	23.0
MUZ30V	28.0	30.0	32.0	2	100	2	1.25	47.5	21	0.1	27.0
MUZ33V	31.0	33.0	35.0	2	100	2	1.80	57.0	19	0.1	30.0
MUZ36V	34.0	36.0	38.0	2	100	2	2.60	63.0	18	0.1	32.5

Note1: TLP parameters: $Z_0 = 50\ \Omega$, $t_p = 100\ \text{ns}$, $t_r = 300\ \text{ps}$, averaging window: $t_1 = 30\ \text{ns}$ to $t_2 = 60\ \text{ns}$, extraction of dynamic resistance using least squares fit of TLP characteristics between $I_{TLP1} = 16\ \text{A}$ and $I_{TLP2} = 30\ \text{A}$.

Note2: $I_{TLP} = 16\ \text{A}$

Note3: $V_R = 0\ \text{V}$, $f = 1\ \text{MHz}$

7. Marking List

Type No.	Marking	Type No.	Marking	Type No.	Marking
MUZ5V6	J1	MUZ11V	JL	MUZ22V	JQ
MUZ6V2	J2	MUZ12V	J6	MUZ24V	JB
MUZ6V8	J3	MUZ13V	JM	MUZ27V	JS
MUZ7V5	JJ	MUZ15V	JN	MUZ30V	JC
MUZ8V2	J4	MUZ16V	J7	MUZ33V	JT
MUZ9V1	JK	MUZ18V	JP	MUZ36V	JD
MUZ10V	J5	MUZ20V	JA	—	—

8. Marking

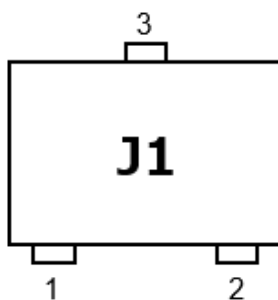

Fig. 8.1 MUZ5V6

9. Land Pattern Dimensions (for reference only)

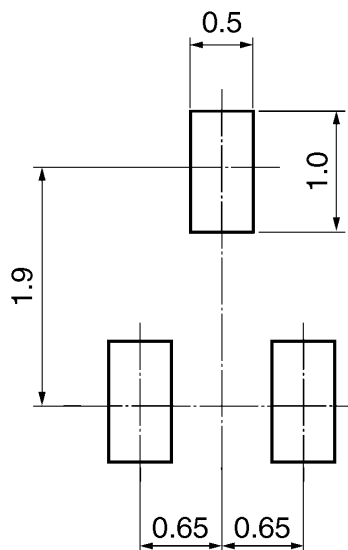

Fig. 9.1 Land Pattern Dimensions
(for reference only) (Unit: mm)

10. Characteristics Curves

10.1. MUZ series Characteristics Curves(Note)

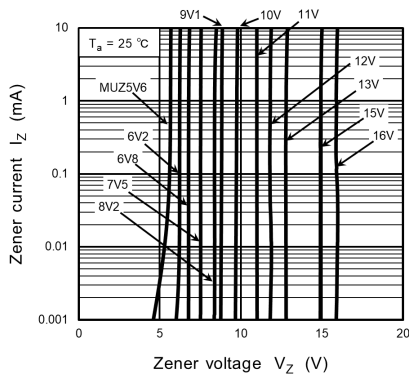

Fig. 10.1.1 $I_z - V_Z(1)$

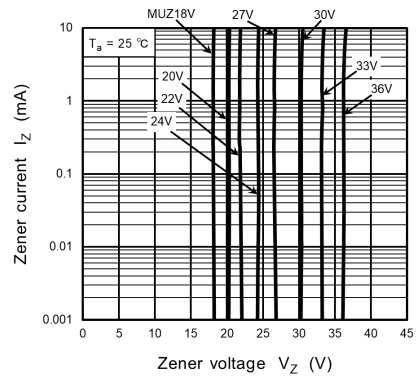

Fig. 10.1.2 $I_z - V_Z(2)$

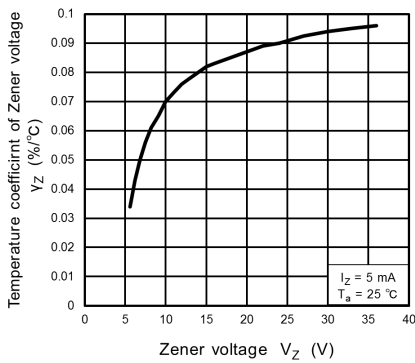

Fig. 10.1.3 $\gamma_Z - V_Z$

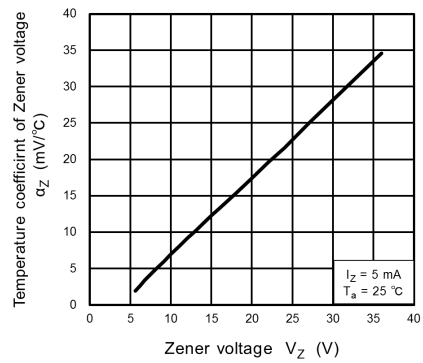

Fig. 10.1.4 $\alpha_Z - V_Z$

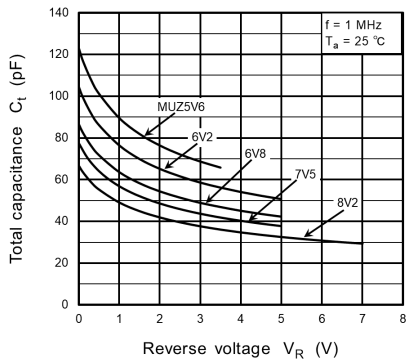

Fig. 10.1.5 $C_t - V_R (1)$

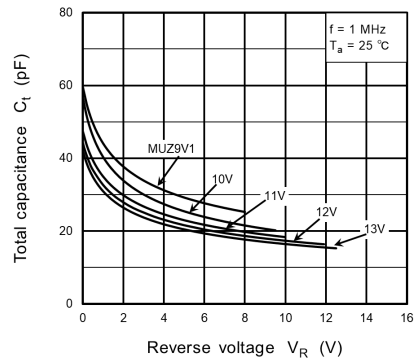

Fig. 10.1.6 $C_t - V_R (2)$

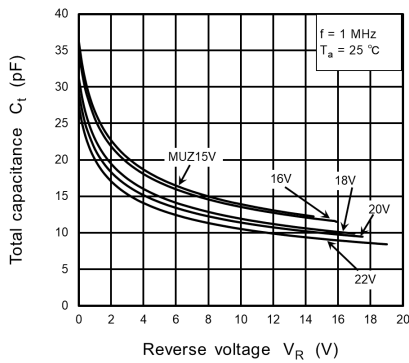

Fig. 10.1.7 $C_t - V_R (3)$

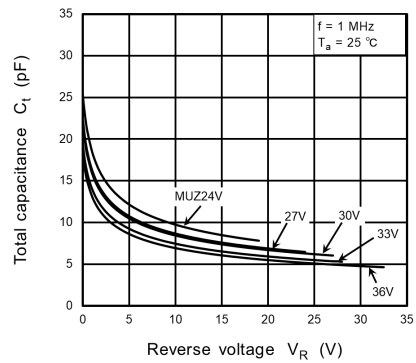

Fig. 10.1.8 $C_t - V_R (4)$

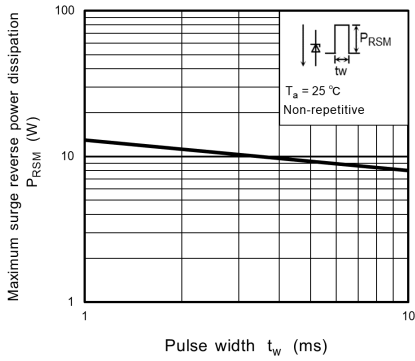

Fig. 10.1.9 $P_{RSM} - t_w$

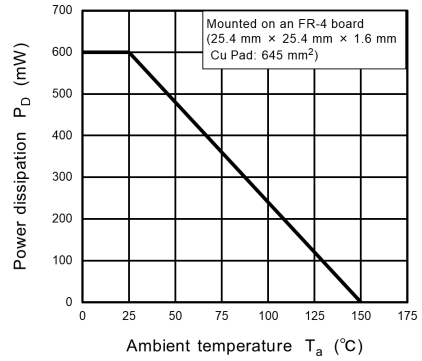

Fig. 10.1.10 $P_D - T_a$

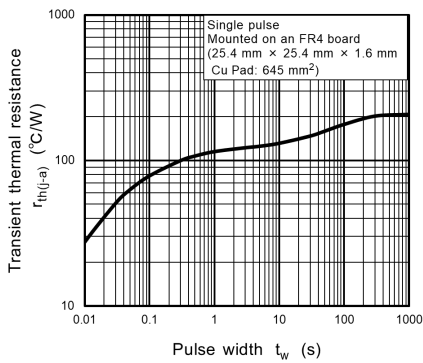

Fig. 10.1.11 $r_{th(j-a)} - t_w$

Note: The above characteristics curves are presented for reference only and not guaranteed by production test, unless otherwise noted.

10.2. MUZ5V6 Characteristics Curves(Note)

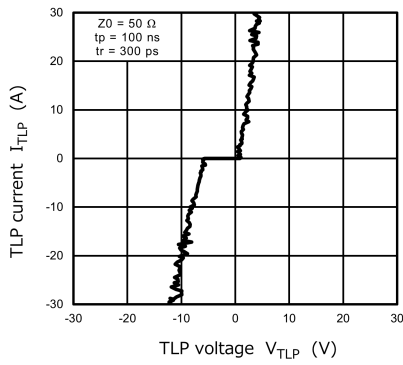

Fig. 10.2.1 $I_{TLP} - V_{TLP}$

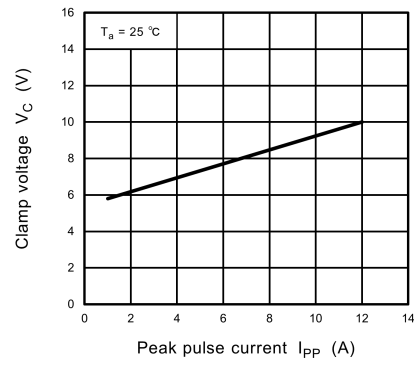

Fig. 10.2.2 $V_C - I_{PP}$

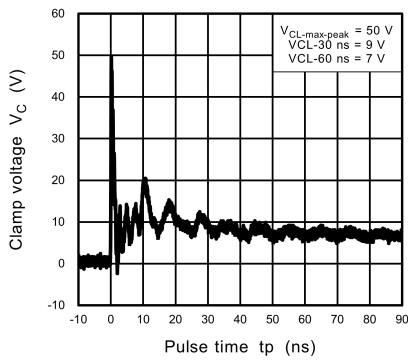

Fig. 10.2.3 IEC61000-4-2 Clamp Waveform +8 kV

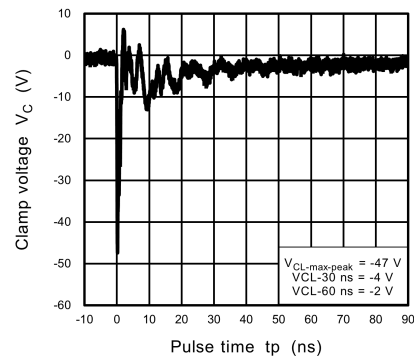

Fig. 10.2.4 IEC61000-4-2 Clamp Waveform -8 kV

Note: The above characteristics curves are presented for reference only and not guaranteed by production test, unless otherwise noted.

Refer to Fig.10.22.1, Fig.10.22.2 for peak pulse current(V_C-I_{PP}) and clamp waveform measurement circuit.

10.3. MUZ6V2 Characteristics Curves(Note)

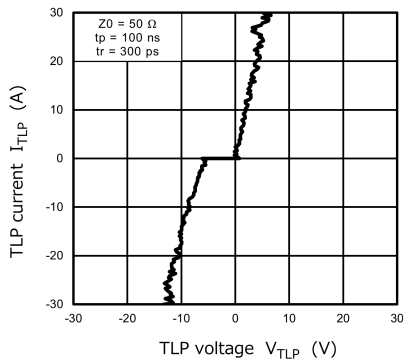

Fig. 10.3.1 $I_{TLP} - V_{TLP}$

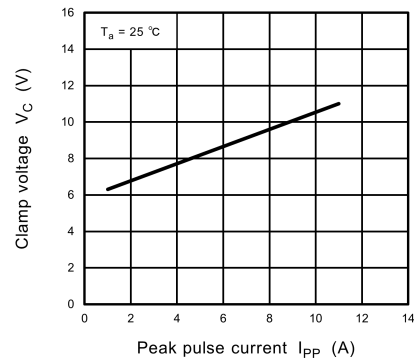
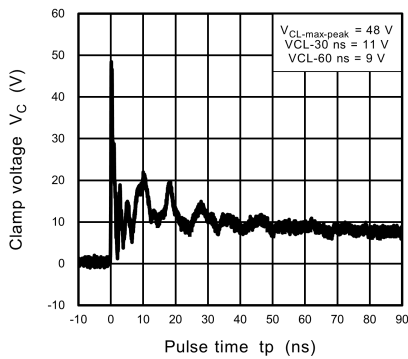
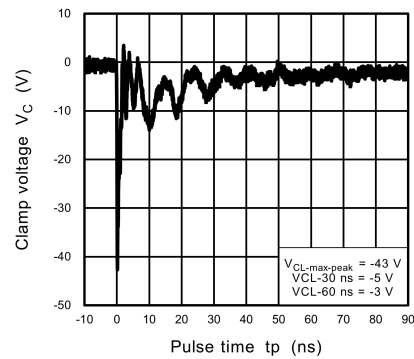

Fig. 10.3.2 $V_C - I_{PP}$



**Fig. 10.3.3 IEC61000-4-2
Clamp Waveform +8 kV**



**Fig. 10.3.4 IEC61000-4-2
Clamp Waveform -8 kV**

Note: The above characteristics curves are presented for reference only and not guaranteed by production test, unless otherwise noted.

Refer to Fig.10.22.1, Fig.10.22.2 for peak pulse current(V_C-I_{PP}) and clamp waveform measurement circuit.

10.4. MUZ6V8 Characteristics Curves(Note)

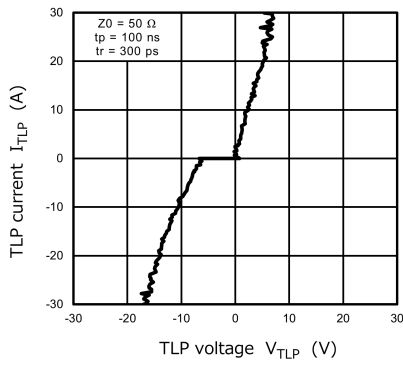

Fig. 10.4.1 $I_{TLP} - V_{TLP}$

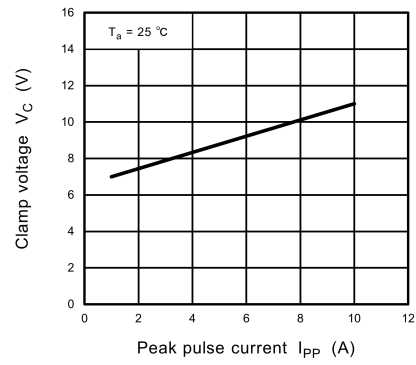

Fig. 10.4.2 $V_C - I_{PP}$

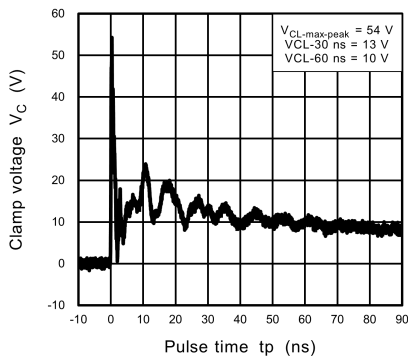

Fig. 10.4.3 IEC61000-4-2
Clamp Waveform +8 kV

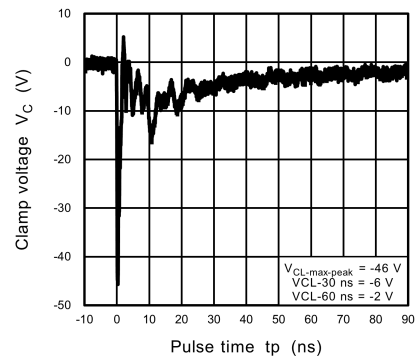

Fig. 10.4.4 IEC61000-4-2
Clamp Waveform -8 kV

Note: The above characteristics curves are presented for reference only and not guaranteed by production test, unless otherwise noted.

Refer to Fig.10.22.1, Fig.10.22.2 for peak pulse current(V_C-I_{PP}) and clamp waveform measurement circuit.

10.5. MUZ7V5 Characteristics Curves(Note)

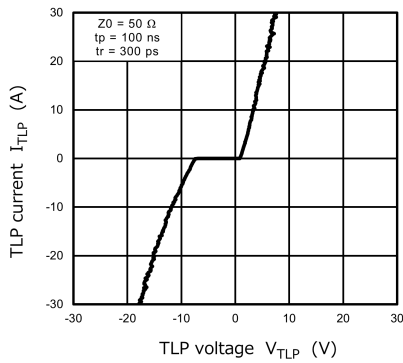

Fig. 10.5.1 $I_{TLP} - V_{TLP}$

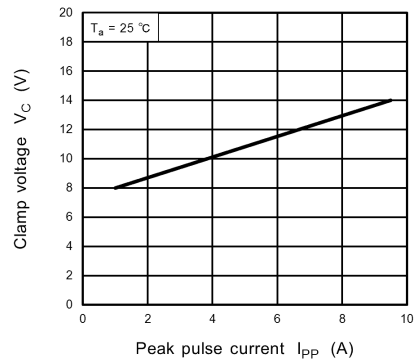
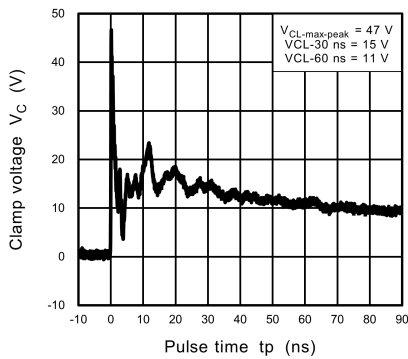
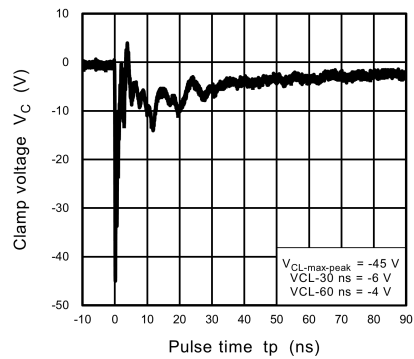

Fig. 10.5.2 $V_C - I_{PP}$



**Fig. 10.5.3 IEC61000-4-2
Clamp Waveform +8 kV**



**Fig. 10.5.4 IEC61000-4-2
Clamp Waveform -8 kV**

Note: The above characteristics curves are presented for reference only and not guaranteed by production test, unless otherwise noted.

Refer to Fig.10.22.1, Fig.10.22.2 for peak pulse current($V_C - I_{PP}$) and clamp waveform measurement circuit.

10.6. MUZ8V2 Characteristics Curves(Note)

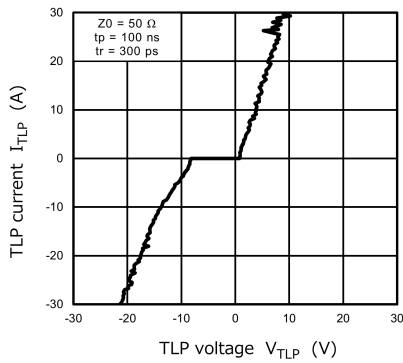

Fig. 10.6.1 $I_{TLP} - V_{TLP}$

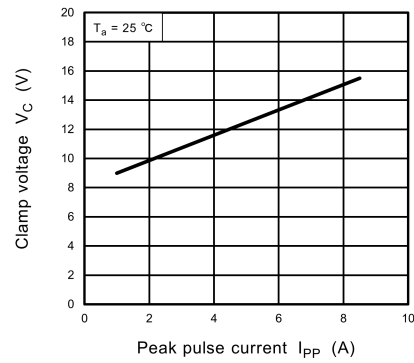

Fig. 10.6.2 $V_C - I_{PP}$

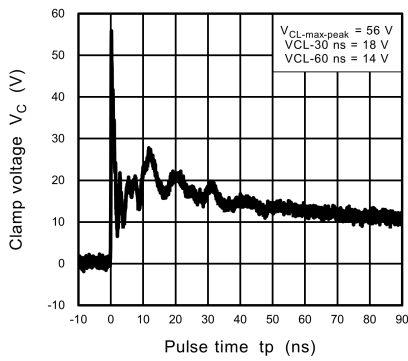

Fig. 10.6.3 IEC61000-4-2
Clamp Waveform +8 kV

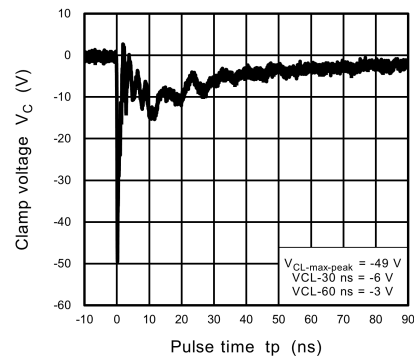

Fig. 10.6.4 IEC61000-4-2
Clamp Waveform -8 kV

Note: The above characteristics curves are presented for reference only and not guaranteed by production test, unless otherwise noted.

Refer to Fig.10.22.1, Fig.10.22.2 for peak pulse current($V_C - I_{PP}$) and clamp waveform measurement circuit.

10.7. MUZ9V1 Characteristics Curves(Note)

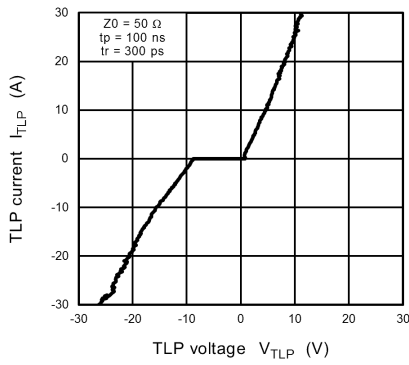

Fig. 10.7.1 $I_{TLP} - V_{TLP}$

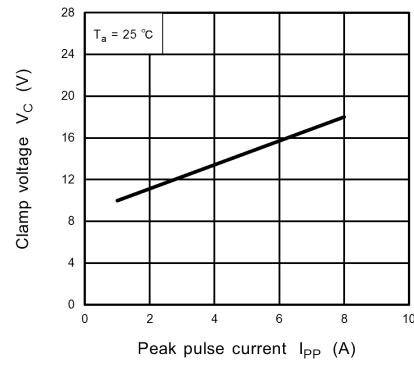
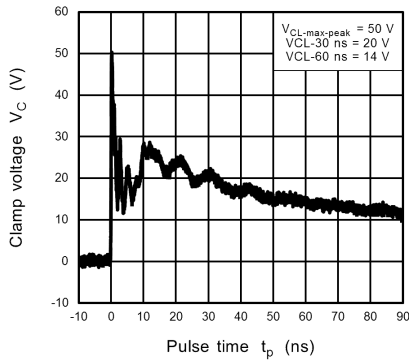
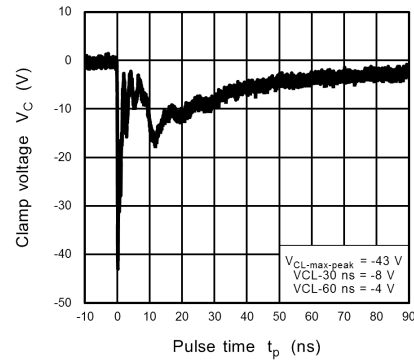

Fig. 10.7.2 $V_C - I_{PP}$



**Fig. 10.7.3 IEC61000-4-2
Clamp Waveform +8 kV**



**Fig. 10.7.4 IEC61000-4-2
Clamp Waveform -8 kV**

Note: The above characteristics curves are presented for reference only and not guaranteed by production test, unless otherwise noted.

Refer to Fig.10.22.1, Fig.10.22.2 for peak pulse current(V_C-I_{PP}) and clamp waveform measurement circuit.

10.8. MUZ10V Characteristics Curves(Note)

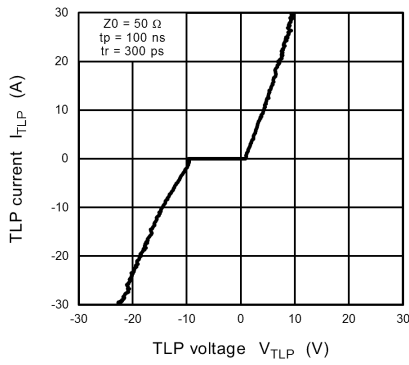

Fig. 10.8.1 $I_{TLP} - V_{TLP}$

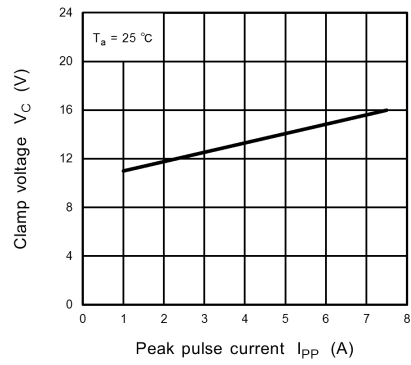
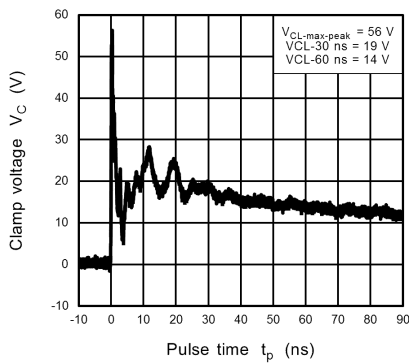
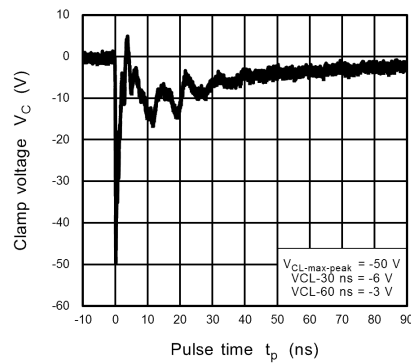

Fig. 10.8.2 $V_C - I_{PP}$



**Fig. 10.8.3 IEC61000-4-2
Clamp Waveform +8 kV**



**Fig. 10.8.4 IEC61000-4-2
Clamp Waveform -8 kV**

Note: The above characteristics curves are presented for reference only and not guaranteed by production test, unless otherwise noted.

Refer to Fig.10.22.1, Fig.10.22.2 for peak pulse current(V_C-I_{PP}) and clamp waveform measurement circuit.

10.9. MUZ11V Characteristics Curves(Note)

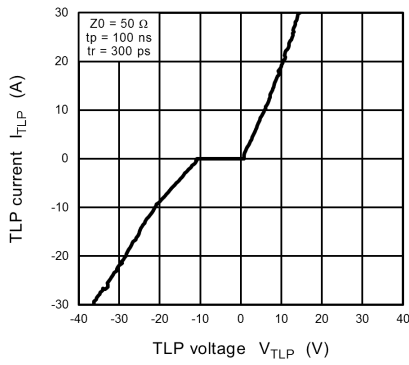

Fig. 10.9.1 $I_{TLP} - V_{TLP}$

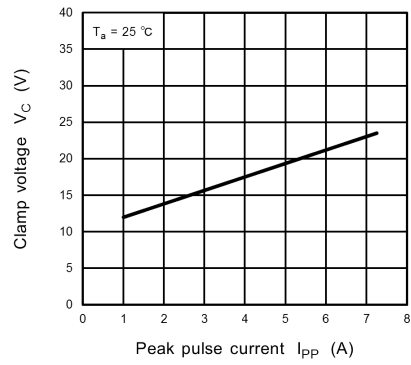

Fig. 10.9.2 $V_C - I_{PP}$

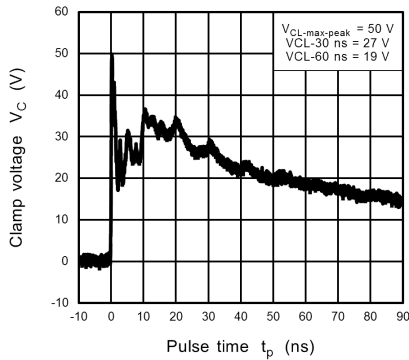

Fig. 10.9.3 IEC61000-4-2
Clamp Waveform +8 kV

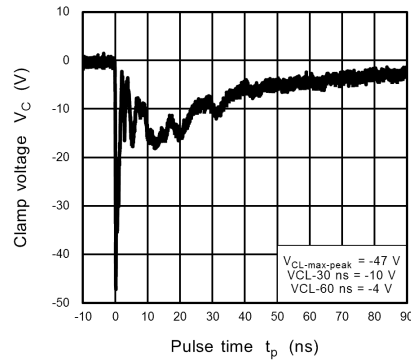

Fig. 10.9.4 IEC61000-4-2
Clamp Waveform -8 kV

Note: The above characteristics curves are presented for reference only and not guaranteed by production test, unless otherwise noted.

Refer to Fig.10.22.1, Fig.10.22.2 for peak pulse current(V_C-I_{PP}) and clamp waveform measurement circuit.

10.10. MUZ12V Characteristics Curves(Note)

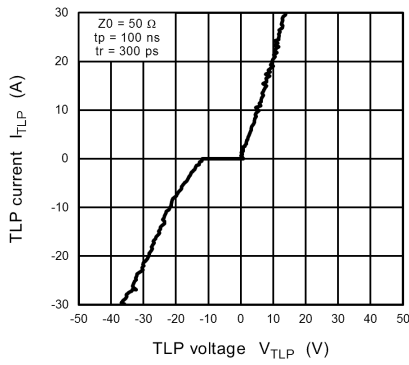

Fig. 10.10.1 $I_{TLP} - V_{TLP}$

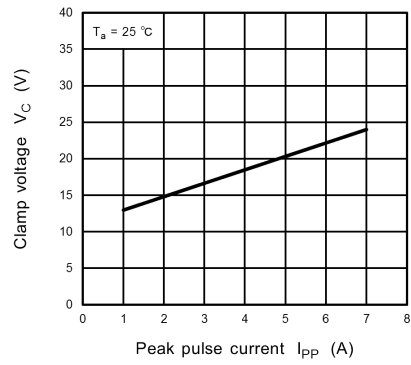
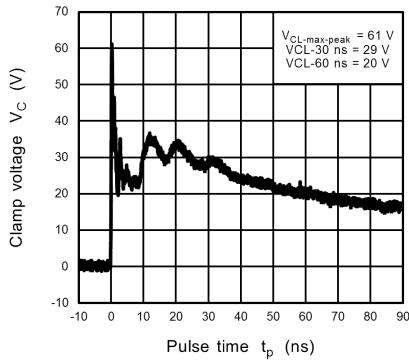
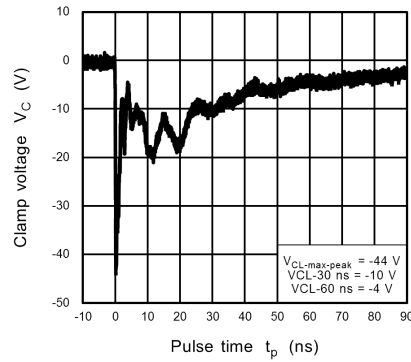

Fig. 10.10.2 $V_C - I_{PP}$



**Fig. 10.10.3 IEC61000-4-2
Clamp Waveform +8 kV**



**Fig. 10.10.4 IEC61000-4-2
Clamp Waveform -8 kV**

Note: The above characteristics curves are presented for reference only and not guaranteed by production test, unless otherwise noted.

Refer to Fig.10.22.1, Fig.10.22.2 for peak pulse current(V_C-I_{PP}) and clamp waveform measurement circuit.

10.11. MUZ13V Characteristics Curves(Note)

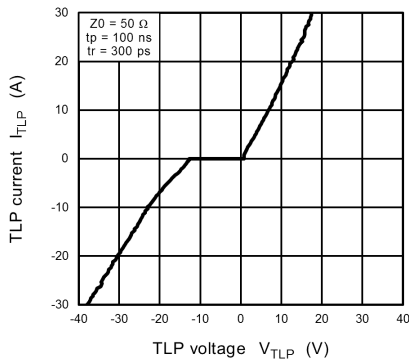

Fig. 10.11.1 $I_{TLP} - V_{TLP}$

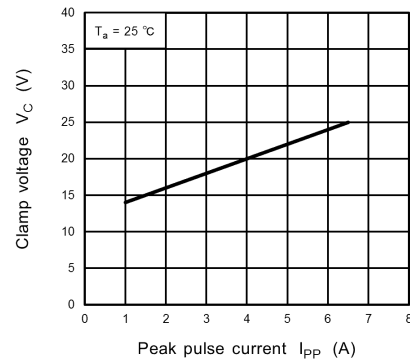
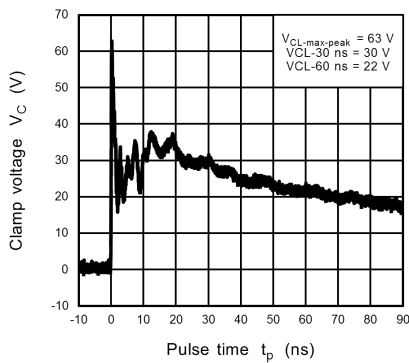
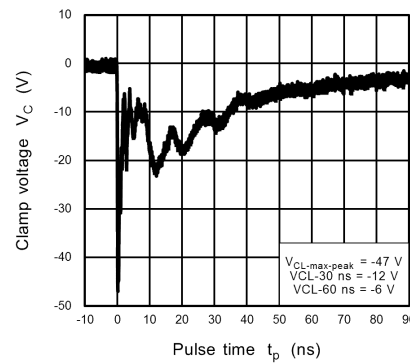

Fig. 10.11.2 $V_C - I_{PP}$



**Fig. 10.11.3 IEC61000-4-2
Clamp Waveform +8 kV**



**Fig. 10.11.4 IEC61000-4-2
Clamp Waveform -8 kV**

Note: The above characteristics curves are presented for reference only and not guaranteed by production test, unless otherwise noted.

Refer to Fig.10.22.1, Fig.10.22.2 for peak pulse current(V_C-I_{PP}) and clamp waveform measurement circuit.

10.12. MUZ15V Characteristics Curves(Note)

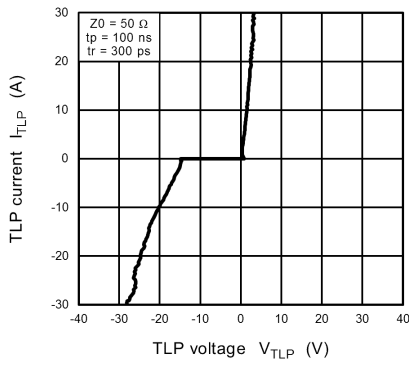

Fig. 10.12.1 $I_{TLP} - V_{TLP}$

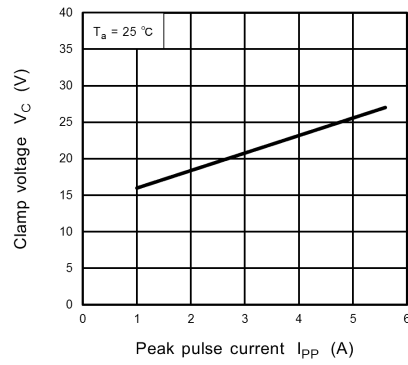
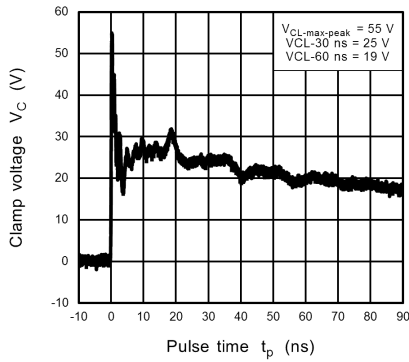
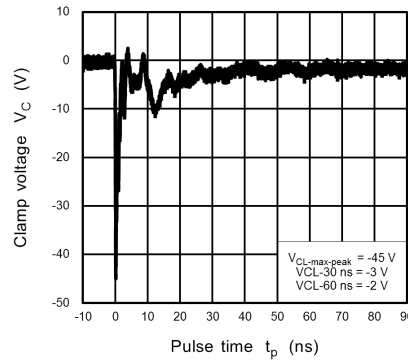

Fig. 10.12.2 $V_C - I_{PP}$



**Fig. 10.12.3 IEC61000-4-2
Clamp Waveform +8 kV**



**Fig. 10.12.4 IEC61000-4-2
Clamp Waveform -8 kV**

Note: The above characteristics curves are presented for reference only and not guaranteed by production test, unless otherwise noted.

Refer to Fig.10.22.1, Fig.10.22.2 for peak pulse current(V_C-I_{PP}) and clamp waveform measurement circuit.

10.13. MUZ16V Characteristics Curves(Note)

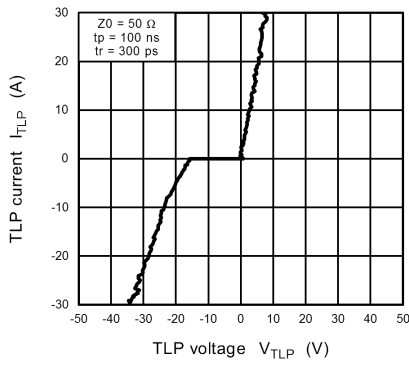

Fig. 10.13.1 $I_{TLP} - V_{TLP}$

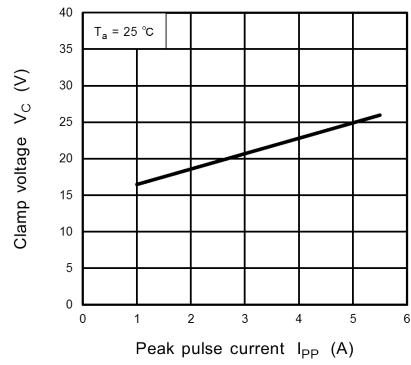
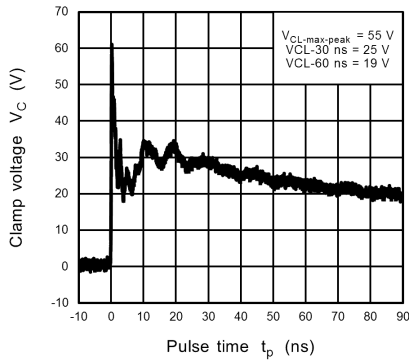
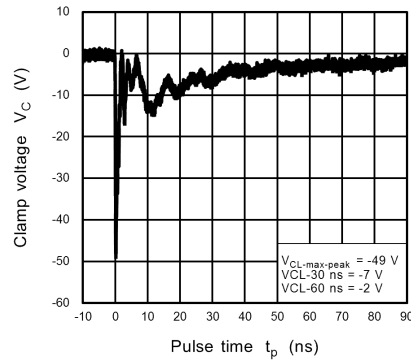

Fig. 10.13.2 $V_C - I_{PP}$



**Fig. 10.13.3 IEC61000-4-2
Clamp Waveform +8 kV**



**Fig. 10.13.4 IEC61000-4-2
Clamp Waveform -8 kV**

Note: The above characteristics curves are presented for reference only and not guaranteed by production test, unless otherwise noted.

Refer to Fig.10.22.1, Fig.10.22.2 for peak pulse current(V_C - I_{PP}) and clamp waveform measurement circuit.

10.14. MUZ18V Characteristics Curves(Note)

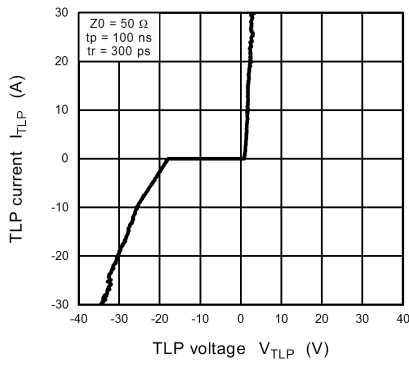

Fig. 10.14.1 $I_{TLP} - V_{TLP}$

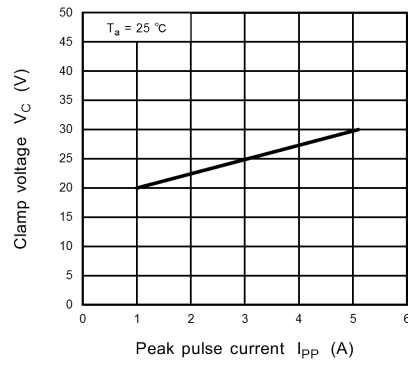
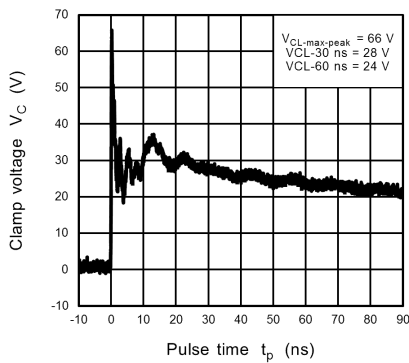
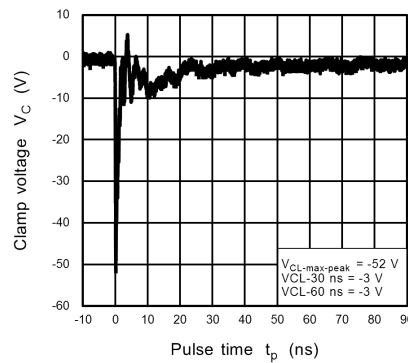

Fig. 10.14.2 $V_C - I_{PP}$



**Fig. 10.14.3 IEC61000-4-2
Clamp Waveform +8 kV**



**Fig. 10.14.4 IEC61000-4-2
Clamp Waveform -8 kV**

Note: The above characteristics curves are presented for reference only and not guaranteed by production test, unless otherwise noted.

Refer to Fig.10.22.1, Fig.10.22.2 for peak pulse current(V_C-I_{PP}) and clamp waveform measurement circuit.

10.15. MUZ20V Characteristics Curves(Note)

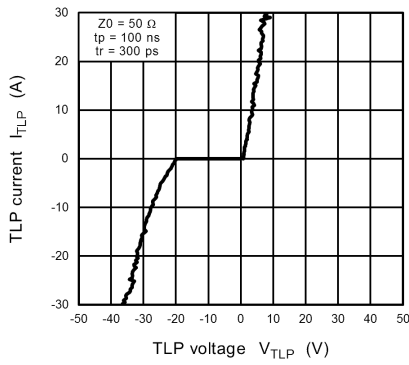

Fig. 10.15.1 $I_{TLP} - V_{TLP}$

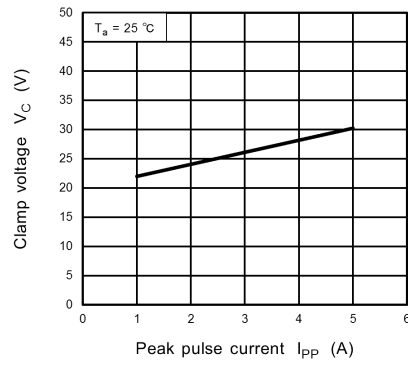
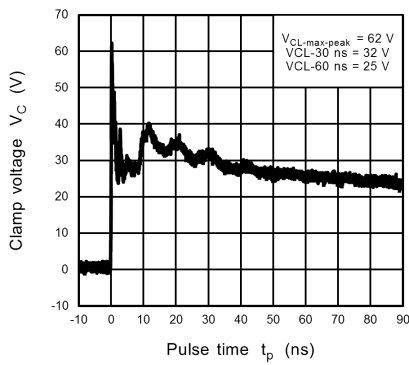
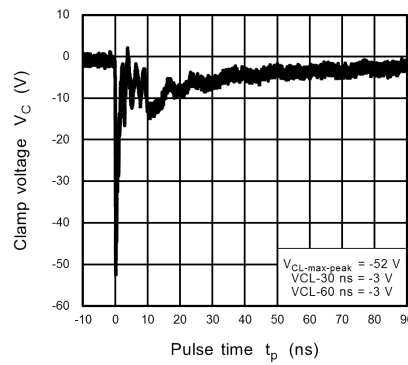

Fig. 10.15.2 $V_C - I_{PP}$



**Fig. 10.15.3 IEC61000-4-2
Clamp Waveform +8 kV**



**Fig. 10.15.4 IEC61000-4-2
Clamp Waveform -8 kV**

Note: The above characteristics curves are presented for reference only and not guaranteed by production test, unless otherwise noted.

Refer to Fig.10.22.1, Fig.10.22.2 for peak pulse current(V_C-I_{PP}) and clamp waveform measurement circuit.

10.16. MUZ22V Characteristics Curves(Note)

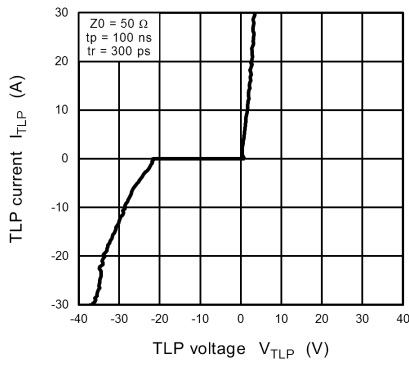

Fig. 10.16.1 $I_{TLP} - V_{TLP}$

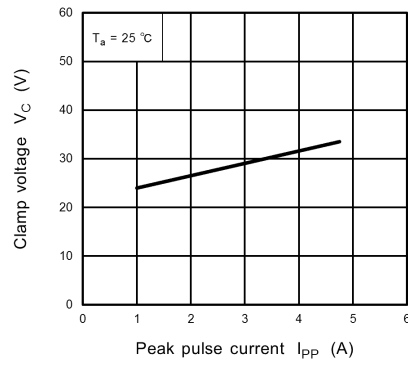
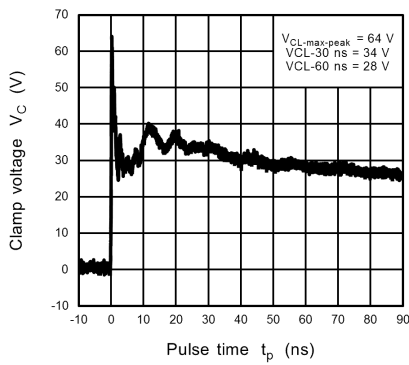
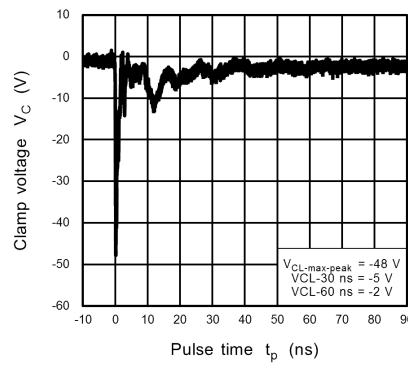

Fig. 10.16.2 $V_C - I_{PP}$



**Fig. 10.16.3 IEC61000-4-2
Clamp Waveform +8 kV**



**Fig. 10.16.4 IEC61000-4-2
Clamp Waveform -8 kV**

Note: The above characteristics curves are presented for reference only and not guaranteed by production test, unless otherwise noted.

Refer to Fig.10.22.1, Fig.10.22.2 for peak pulse current(V_C-I_{PP}) and clamp waveform measurement circuit.

10.17. MUZ24V Characteristics Curves(Note)

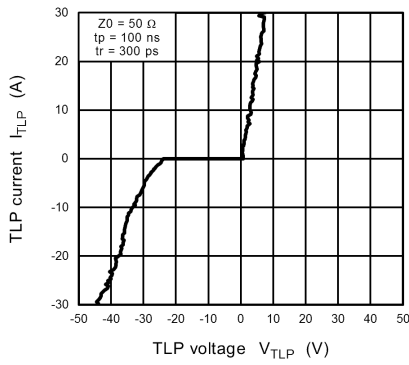

Fig. 10.17.1 $I_{TLP} - V_{TLP}$

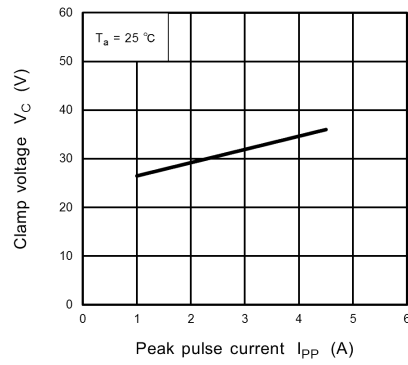
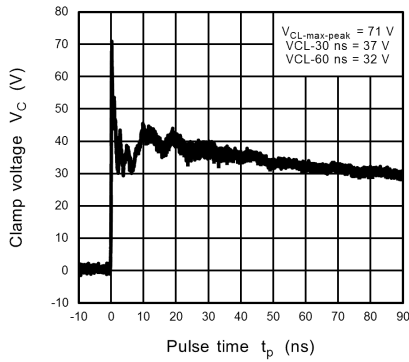
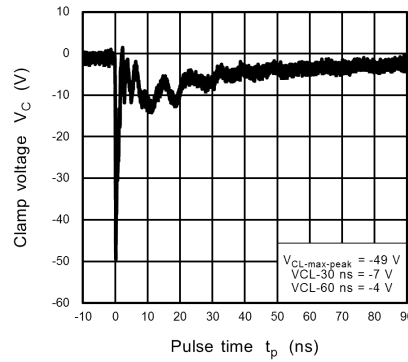

Fig. 10.17.2 $V_C - I_{PP}$



**Fig. 10.17.3 IEC61000-4-2
Clamp Waveform +8 kV**



**Fig. 10.17.4 IEC61000-4-2
Clamp Waveform -8 kV**

Note: The above characteristics curves are presented for reference only and not guaranteed by production test, unless otherwise noted.

Refer to Fig.10.22.1, Fig.10.22.2 for peak pulse current(V_C - I_{PP}) and clamp waveform measurement circuit.

10.18. MUZ27V Characteristics Curves(Note)

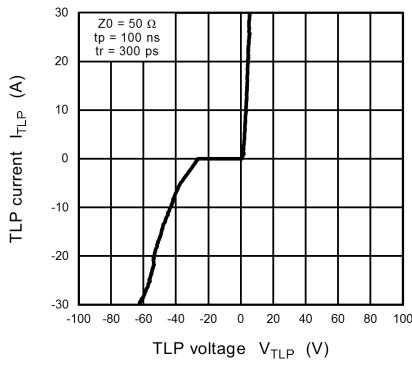

Fig. 10.18.1 $I_{TLP} - V_{TLP}$

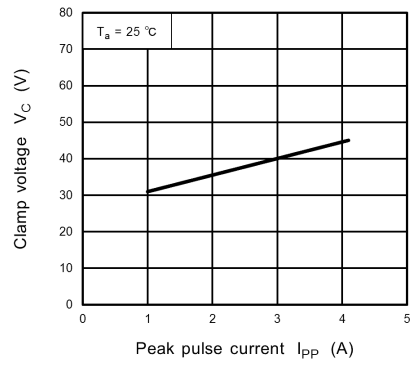
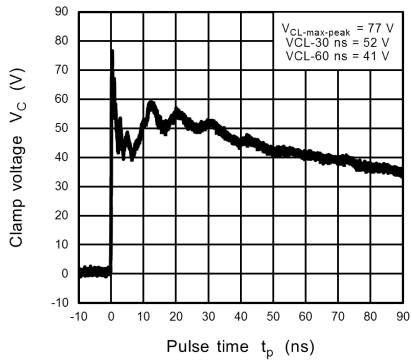
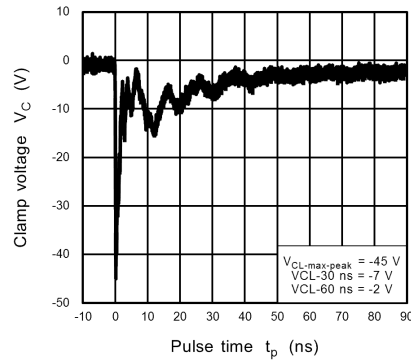

Fig. 10.18.2 $V_C - I_{PP}$



**Fig. 10.18.3 IEC61000-4-2
Clamp Waveform +8 kV**



**Fig. 10.18.4 IEC61000-4-2
Clamp Waveform -8 kV**

Note: The above characteristics curves are presented for reference only and not guaranteed by production test, unless otherwise noted.

Refer to Fig.10.22.1, Fig.10.22.2 for peak pulse current(V_C-I_{PP}) and clamp waveform measurement circuit.

10.19. MUZ30V Characteristics Curves(Note)

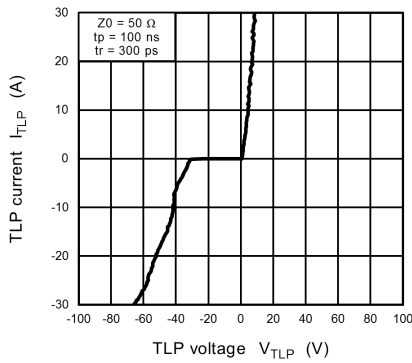

Fig. 10.19.1 $I_{TLP} - V_{TLP}$

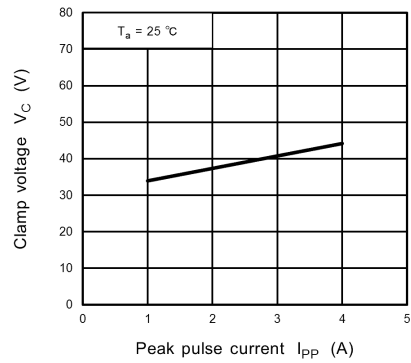

Fig. 10.19.2 $V_C - I_{PP}$

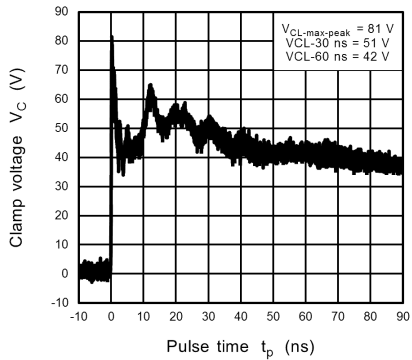

Fig. 10.19.3 IEC61000-4-2
Clamp Waveform +8 kV

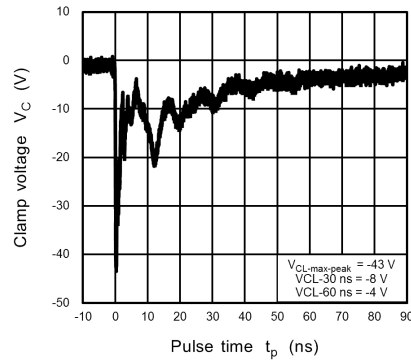

Fig. 10.19.4 IEC61000-4-2
Clamp Waveform -8 kV

Note: The above characteristics curves are presented for reference only and not guaranteed by production test, unless otherwise noted.

Refer to Fig.10.22.1, Fig.10.22.2 for peak pulse current(V_C-I_{PP}) and clamp waveform measurement circuit.

10.20. MUZ33V Characteristics Curves(Note)

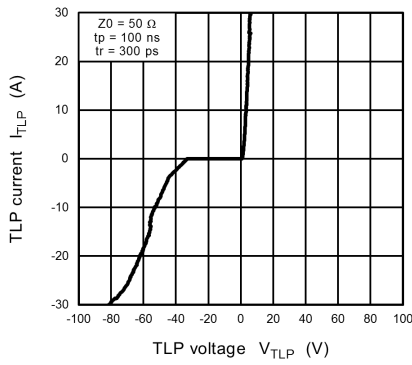

Fig. 10.20.1 $I_{TLP} - V_{TLP}$

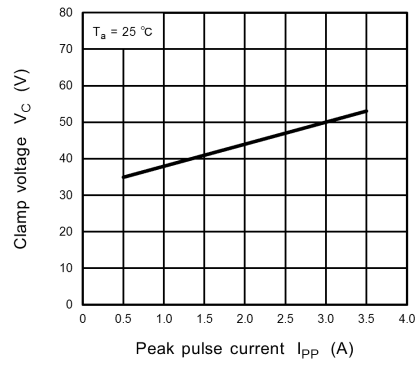
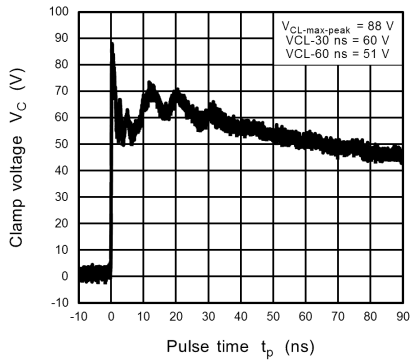
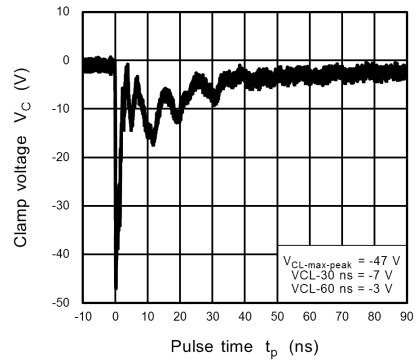

Fig. 10.20.2 $V_C - I_{PP}$



**Fig. 10.20.3 IEC61000-4-2
Clamp Waveform +8 kV**



**Fig. 10.20.4 IEC61000-4-2
Clamp Waveform -8 kV**

Note: The above characteristics curves are presented for reference only and not guaranteed by production test, unless otherwise noted.

Refer to Fig.10.22.1, Fig.10.22.2 for peak pulse current(V_C-I_{PP}) and clamp waveform measurement circuit.

10.21. MUZ36V Characteristics Curves(Note)

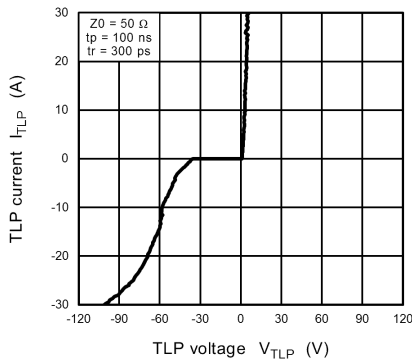

Fig. 10.21.1 $I_{TLP} - V_{TLP}$

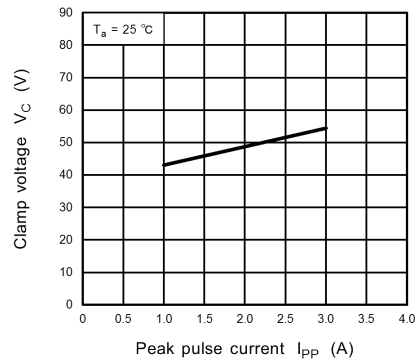

Fig. 10.21.2 $V_C - I_{PP}$

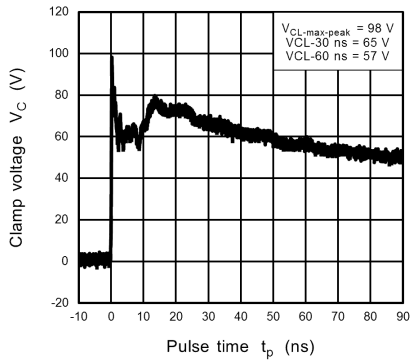

Fig. 10.21.3 IEC61000-4-2
Clamp Waveform +8 kV

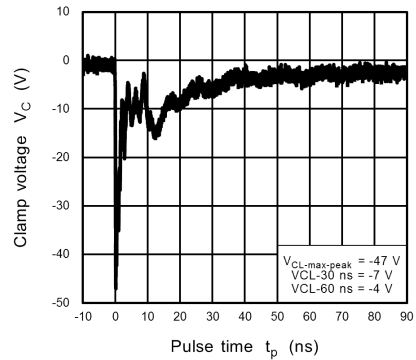

Fig. 10.21.4 IEC61000-4-2
Clamp Waveform -8 kV

Note: The above characteristics curves are presented for reference only and not guaranteed by production test, unless otherwise noted.

Refer to Fig.10.22.1, Fig.10.22.2 for peak pulse current(V_C-I_{PP}) and clamp waveform measurement circuit.

10.22. V_C-I_{PP} Peak Pulse and Clamp waveform measurement circuit

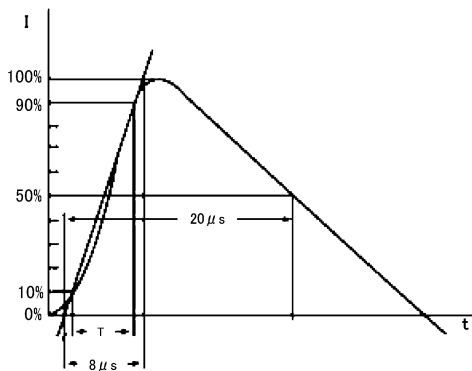

Fig. 10.22.1 V_C-I_{PP} Peak Pulse Current
(according to IEC61000-4-5 8/20 μ s pulse)

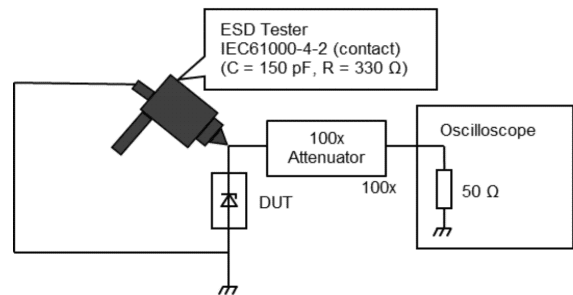
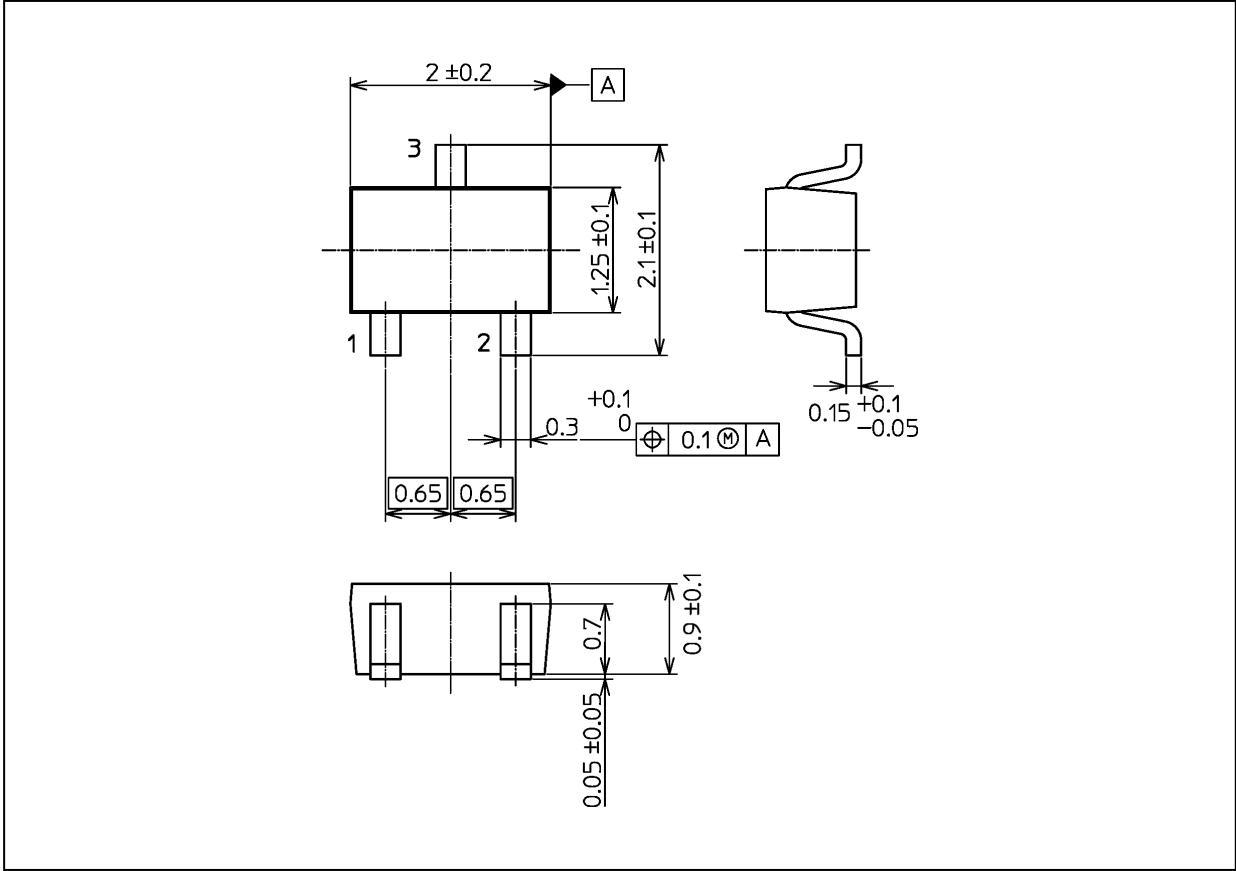

Fig. 10.22.2 Clamp waveform measurement
circuit (according to IEC61000-4-2)

Package Dimensions

Unit: mm



Weight: 6.0 mg (typ.)

Package Name(s)
Nickname: USM

RESTRICTIONS ON PRODUCT USE

Toshiba Corporation and its subsidiaries and affiliates are collectively referred to as "TOSHIBA".

Hardware, software and systems described in this document are collectively referred to as "Product".

- TOSHIBA reserves the right to make changes to the information in this document and related Product without notice.
- This document and any information herein may not be reproduced without prior written permission from TOSHIBA. Even with TOSHIBA's written permission, reproduction is permissible only if reproduction is without alteration/omission.
- Though TOSHIBA works continually to improve Product's quality and reliability, Product can malfunction or fail. Customers are responsible for complying with safety standards and for providing adequate designs and safeguards for their hardware, software and systems which minimize risk and avoid situations in which a malfunction or failure of Product could cause loss of human life, bodily injury or damage to property, including data loss or corruption. Before customers use the Product, create designs including the Product, or incorporate the Product into their own applications, customers must also refer to and comply with (a) the latest versions of all relevant TOSHIBA information, including without limitation, this document, the specifications, the data sheets and application notes for Product and the precautions and conditions set forth in the "TOSHIBA Semiconductor Reliability Handbook" and (b) the instructions for the application with which the Product will be used with or for. Customers are solely responsible for all aspects of their own product design or applications, including but not limited to (a) determining the appropriateness of the use of this Product in such design or applications; (b) evaluating and determining the applicability of any information contained in this document, or in charts, diagrams, programs, algorithms, sample application circuits, or any other referenced documents; and (c) validating all operating parameters for such designs and applications. **TOSHIBA ASSUMES NO LIABILITY FOR CUSTOMERS' PRODUCT DESIGN OR APPLICATIONS.**
- **PRODUCT IS NEITHER INTENDED NOR WARRANTED FOR USE IN EQUIPMENTS OR SYSTEMS THAT REQUIRE EXTRAORDINARILY HIGH LEVELS OF QUALITY AND/OR RELIABILITY, AND/OR A MALFUNCTION OR FAILURE OF WHICH MAY CAUSE LOSS OF HUMAN LIFE, BODILY INJURY, SERIOUS PROPERTY DAMAGE AND/OR SERIOUS PUBLIC IMPACT ("UNINTENDED USE").** Except for specific applications as expressly stated in this document, Unintended Use includes, without limitation, equipment used in nuclear facilities, equipment used in the aerospace industry, Class 3 medical devices, equipment used for automobiles, and military vehicles and munitions. **IF YOU USE PRODUCT FOR UNINTENDED USE, TOSHIBA ASSUMES NO LIABILITY FOR PRODUCT.** For details, please contact your TOSHIBA sales representative or contact us via our website.
- Do not disassemble, analyze, reverse-engineer, alter, modify, translate or copy Product, whether in whole or in part.
- Product shall not be used for or incorporated into any products or systems whose manufacture, use, or sale is prohibited under any applicable laws or regulations.
- The information contained herein is presented only as guidance for Product use. No responsibility is assumed by TOSHIBA for any infringement of patents or any other intellectual property rights of third parties that may result from the use of Product. No license to any intellectual property right is granted by this document, whether express or implied, by estoppel or otherwise.
- **ABSENT A WRITTEN SIGNED AGREEMENT, EXCEPT AS PROVIDED IN THE RELEVANT TERMS AND CONDITIONS OF SALE FOR PRODUCT, AND TO THE MAXIMUM EXTENT ALLOWABLE BY LAW, TOSHIBA (1) ASSUMES NO LIABILITY WHATSOEVER, INCLUDING WITHOUT LIMITATION, INDIRECT, CONSEQUENTIAL, SPECIAL, OR INCIDENTAL DAMAGES OR LOSS, INCLUDING WITHOUT LIMITATION, LOSS OF PROFITS, LOSS OF OPPORTUNITIES, BUSINESS INTERRUPTION AND LOSS OF DATA, AND (2) DISCLAIMS ANY AND ALL EXPRESS OR IMPLIED WARRANTIES AND CONDITIONS RELATED TO SALE, USE OF PRODUCT, OR INFORMATION, INCLUDING WARRANTIES OR CONDITIONS OF MERCHANTABILITY, FITNESS FOR A PARTICULAR PURPOSE, ACCURACY OF INFORMATION, OR NONINFRINGEMENT.**
- Do not use or otherwise make available Product or related software or technology for any military purposes, including without limitation, for the design, development, use, stockpiling or manufacturing of nuclear, chemical, or biological weapons or missile technology products (mass destruction weapons). Product and related software and technology may be controlled under the applicable export laws and regulations including, without limitation, the Japanese Foreign Exchange and Foreign Trade Law and the U.S. Export Administration Regulations. Export and re-export of Product or related software or technology are strictly prohibited except in compliance with all applicable export laws and regulations.
- Please contact your TOSHIBA sales representative for details as to environmental matters such as the RoHS compatibility of Product. Please use Product in compliance with all applicable laws and regulations that regulate the inclusion or use of controlled substances, including without limitation, the EU RoHS Directive. **TOSHIBA ASSUMES NO LIABILITY FOR DAMAGES OR LOSSES OCCURRING AS A RESULT OF NONCOMPLIANCE WITH APPLICABLE LAWS AND REGULATIONS.**