

Zener Diode Silicon Epitaxial Planar

CUZ series

1. Applications

- (1) Voltage surge protection

2. Features

- (1) Small package
- (2) The typical voltage of VZ is accorded to E24 series.

3. Packaging and Internal Circuit

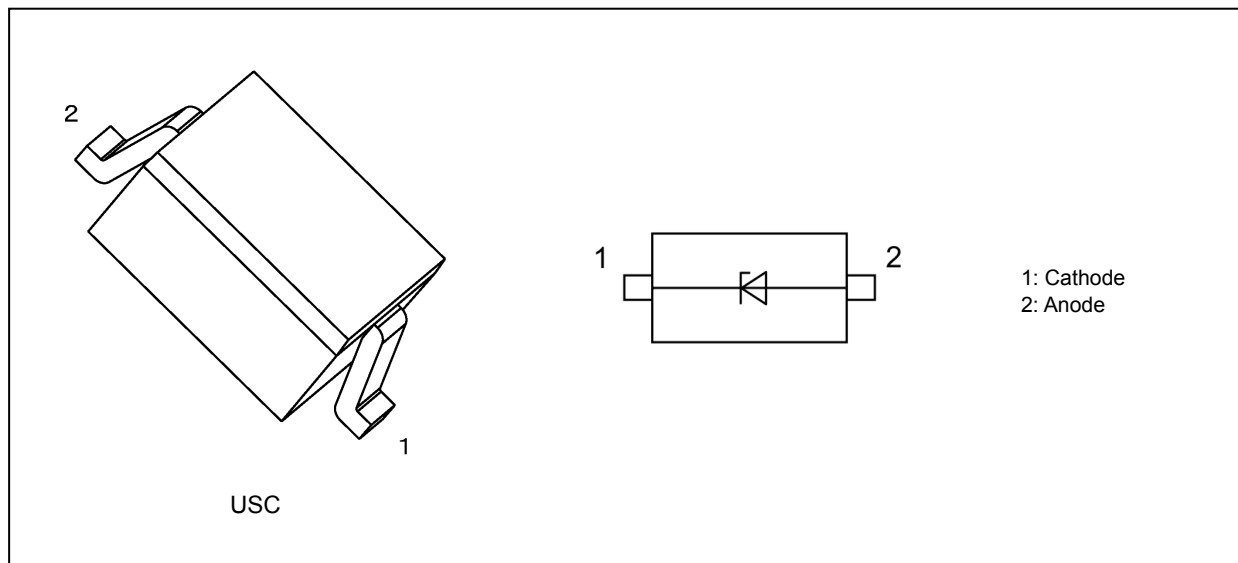

4. Absolute Maximum Ratings 1 (Note) (Unless otherwise specified, $T_a = 25\text{ }^\circ\text{C}$)

Characteristics	Symbol	Note	Rating	Unit
Power dissipation	P_D	(Note 1)	200	mW
		(Note 2)	600	
Junction temperature	T_j		150	$^\circ\text{C}$
Storage temperature	T_{stg}		-55 to 150	

Note: Using continuously under heavy loads (e.g. the application of high temperature/current/voltage and the significant change in temperature, etc.) may cause this product to decrease in the reliability significantly even if the operating conditions (i.e. operating temperature/current/voltage, etc.) are within the absolute maximum ratings.

Please design the appropriate reliability upon reviewing the Toshiba Semiconductor Reliability Handbook ("Handling Precautions"/"Derating Concept and Methods") and individual reliability data (i.e. reliability test report and estimated failure rate, etc).

Note 1: Mounted on a glass epoxy circuit board of 20 mm × 20 mm, Cu pad: 4 mm × 4 mm.

Note 2: Mounted on a glass epoxy circuit board of 25.4 mm × 25.4 mm × 1.6 mm, Cu pad: 645 mm²

Start of commercial production

2020-07

5. Absolute Maximum Ratings 2 (Note) (Unless otherwise specified, $T_a = 25\text{ }^\circ\text{C}$)

Type No.	Electrostatic discharge voltage (Contact, Air) $V_{ESD}(kV)$ (Note 1)	Peak pulse power $P_{PK}(W)$ (Note 2)	Peak pulse current $I_{PP}(A)$ (Note 2)
CUZ5V6	±30	155	12.0
CUZ6V2	±30	175	11.0
CUZ6V8	±30	180	10.0
CUZ7V5	±30	190	9.5
CUZ8V2	±30	200	8.5
CUZ9V1	±30	200	8.0
CUZ10V	±30	200	7.5
CUZ11V	±30	200	7.25
CUZ12V	±30	200	7.0
CUZ13V	±30	200	6.5
CUZ15V	±30	200	5.6
CUZ16V	±30	200	5.5
CUZ18V	±30	200	5.1
CUZ20V	±30	200	5.0
CUZ22V	±30	200	4.75
CUZ24V	±30	200	4.5
CUZ27V	±20	200	4.1
CUZ30V	±20	200	4.0
CUZ33V	±17	200	3.5
CUZ36V	±12	200	3.0

Note: Using continuously under heavy loads (e.g. the application of high temperature/current/voltage and the significant change in temperature, etc.) may cause this product to decrease in the reliability significantly even if the operating conditions (i.e. operating temperature/current/voltage, etc.) are within the absolute maximum ratings.

Please design the appropriate reliability upon reviewing the Toshiba Semiconductor Reliability Handbook ("Handling Precautions"/"Derating Concept and Methods") and individual reliability data (i.e. reliability test report and estimated failure rate, etc).

Note1: According to IEC61000-4-2.

Note2: According to IEC61000-4-5 ($t_p = 8 / 20\text{ }\mu\text{s}$)

6. Electrical Characteristics (Unless otherwise specified, $T_a = 25\text{ }^\circ\text{C}$)

Type No.	Zener Voltage V_Z (V)				Dynamic Impedance Z_Z (Ω)		Dynamic Resistance R_{DYN} (Ω) (Note 1)	Clamp Voltage V_C (V) (Note 1) (Note 2)	Total Capacitance C_t (pF) (Note 3)	Reverse Current I_R (μA)	
	Min	Typ.	Max	Test Current I_Z (mA)	Max	Test Current I_Z (mA)	Typ.	Typ.	Typ.	Max	Test Voltage V_R (V)
CUZ5V6	5.3	5.6	6.0	5	30	5	0.16	9.0	125	1	3.5
CUZ6V2	5.8	6.2	6.6	5	30	5	0.21	10.0	105	2.5	5.0
CUZ6V8	6.4	6.8	7.2	5	30	5	0.27	13.0	88	1.5	5.5
CUZ7V5	7.0	7.5	7.9	5	30	5	0.32	14.0	78	0.1	6.0
CUZ8V2	7.7	8.2	8.7	5	30	5	0.37	16.5	67	0.1	7.0
CUZ9V1	8.5	9.1	9.6	5	30	5	0.44	17.0	62	0.1	7.5
CUZ10V	9.4	10.0	10.6	5	30	5	0.52	19.0	60	0.1	8.0
CUZ11V	10.4	11.0	11.6	5	30	5	0.60	24.0	48	0.1	9.0
CUZ12V	11.4	12.0	12.6	5	30	5	0.70	26.0	44	0.1	10.0
CUZ13V	12.4	13.0	14.1	5	30	5	0.80	27.0	42	0.1	11.0
CUZ15V	13.8	15.0	15.6	5	30	5	0.60	24.0	36	0.1	12.0
CUZ16V	15.3	16.0	17.1	5	35	5	0.50	27.0	35	0.1	14.0
CUZ18V	16.8	18.0	19.1	5	45	5	0.40	28.5	31	0.1	16.0
CUZ20V	18.8	20.0	21.2	5	70	5	0.35	30.5	29	0.1	17.6
CUZ22V	20.8	22.0	23.3	5	70	5	0.40	32.0	27	0.1	18.0
CUZ24V	22.8	24.0	25.6	5	70	5	0.60	36.5	26	0.1	19.0
CUZ27V	25.1	27.0	28.9	2	70	2	0.90	45.0	23	0.1	23.0
CUZ30V	28.0	30.0	32.0	2	100	2	1.25	47.5	21	0.1	27.0
CUZ33V	31.0	33.0	35.0	2	100	2	1.80	57.0	19	0.1	30.0
CUZ36V	34.0	36.0	38.0	2	100	2	2.60	63.0	18	0.1	32.5

Note1: TLP parameters: $Z_0 = 50\ \Omega$, $t_p = 100\ \text{ns}$, $t_r = 300\ \text{ps}$, averaging window: $t_1 = 30\ \text{ns}$ to $t_2 = 60\ \text{ns}$, extraction of dynamic resistance using least squares fit of TLP characteristics between $I_{TLP1} = 16\ \text{A}$ and $I_{TLP2} = 30\ \text{A}$.

Note2: $I_{TLP} = 16\ \text{A}$

Note3: $V_R = 0\ \text{V}$, $f = 1\ \text{MHz}$

7. Marking List

Type No.	Marking	Type No.	Marking	Type No.	Marking
CUZ5V6	LL	CUZ11V	M3	CUZ22V	MA
CUZ6V2	LM	CUZ12V	M4	CUZ24V	MB
CUZ6V8	LN	CUZ13V	M5	CUZ27V	MC
CUZ7V5	LP	CUZ15V	M6	CUZ30V	MD
CUZ8V2	LQ	CUZ16V	M7	CUZ33V	ME
CUZ9V1	LR	CUZ18V	M8	CUZ36V	MF
CUZ10V	M2	CUZ20V	M9	—	—

8. Marking

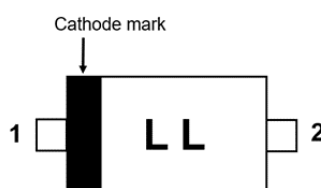

Fig. 8.1 CUZ5V6

9. Land Pattern Dimensions (for reference only)

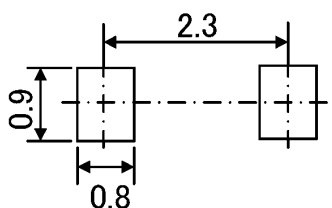

Fig. 9.1 Land Pattern Dimensions
(for reference only) (Unit: mm)

10. Characteristics Curves

10.1. CUZ series Characteristics Curves(Note)

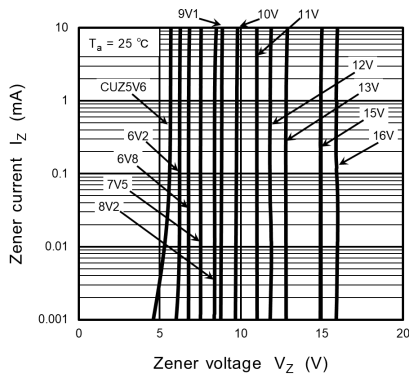

Fig. 10.1.1 $I_Z - V_Z(1)$

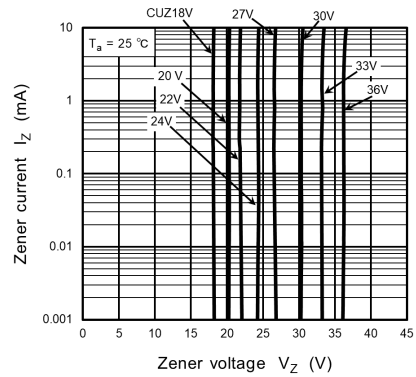

Fig. 10.1.2 $I_Z - V_Z(2)$

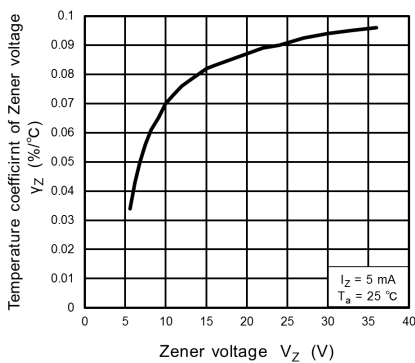

Fig. 10.1.3 $\gamma_Z - V_Z$

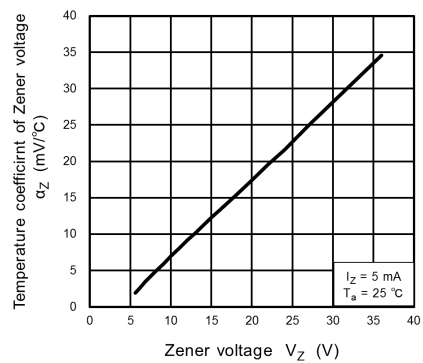

Fig. 10.1.4 $\alpha_Z - V_Z$

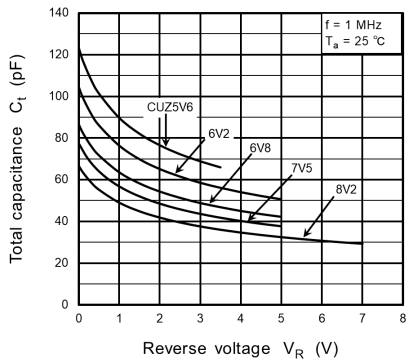

Fig. 10.1.5 $C_t - V_R (1)$

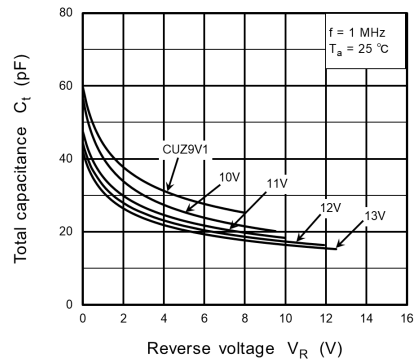

Fig. 10.1.6 $C_t - V_R (2)$

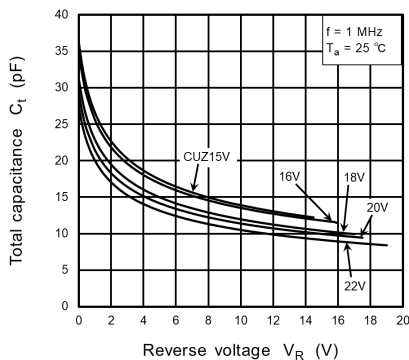

Fig. 10.1.7 $C_t - V_R (3)$

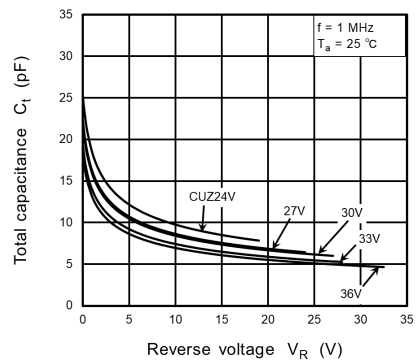

Fig. 10.1.8 $C_t - V_R (4)$

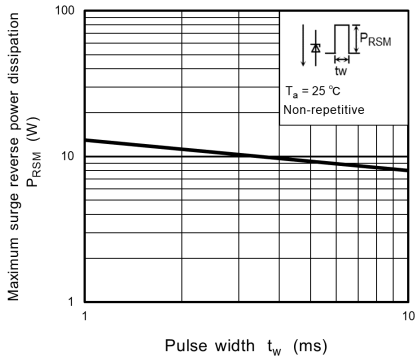

Fig. 10.1.9 $P_{RSM} - t_w$

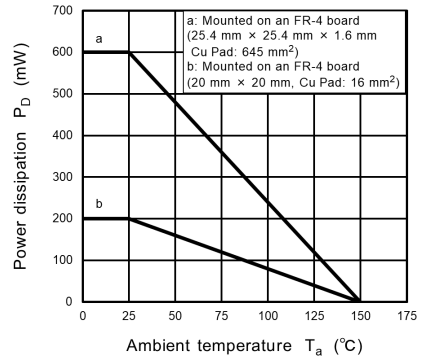

Fig. 10.1.10 $P_D - T_a$

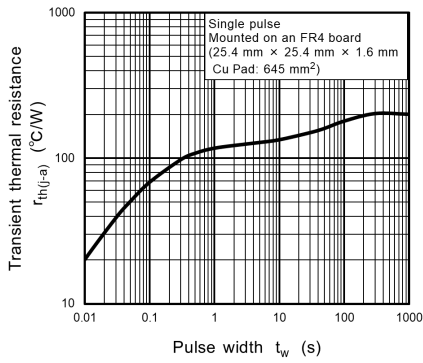

Fig. 10.1.11 $r_{th(j-a)} - t_w$

Note: The above characteristics curves are presented for reference only and not guaranteed by production test, unless otherwise noted.

10.2. CUZ5V6 Characteristics Curves(Note)

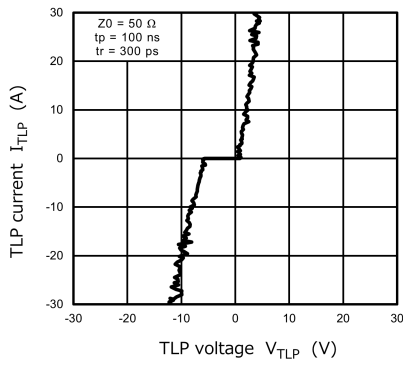

Fig. 10.2.1 $I_{TLP} - V_{TLP}$

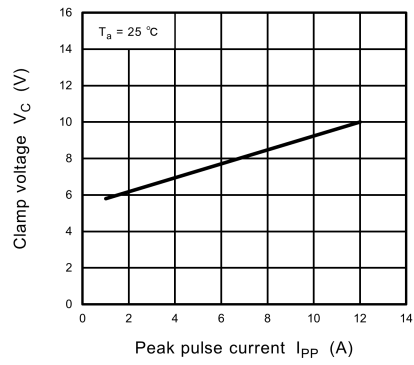

Fig. 10.2.2 $V_C - I_{PP}$

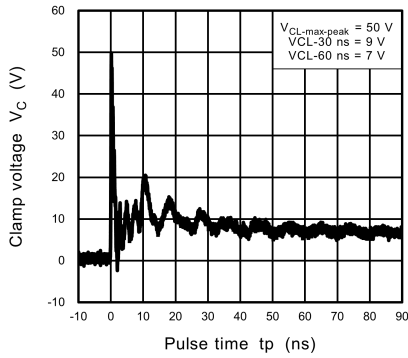

Fig. 10.2.3 IEC61000-4-2 Clamp Waveform +8 kV

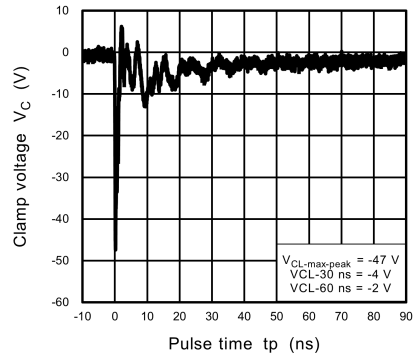

Fig. 10.2.4 IEC61000-4-2 Clamp Waveform -8 kV

Note: The above characteristics curves are presented for reference only and not guaranteed by production test, unless otherwise noted.

Refer to Fig.10.22.1, Fig.10.22.2 for peak pulse current(V_C-I_{PP}) and clamp waveform measurement circuit.

10.3. CUZ6V2 Characteristics Curves(Note)

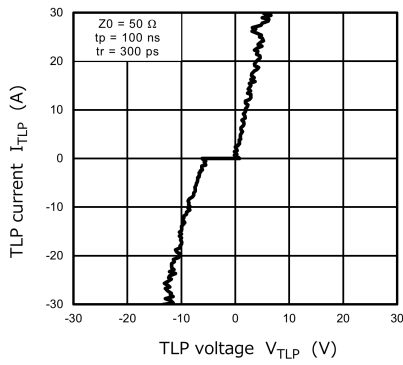

Fig. 10.3.1 $I_{TLP} - V_{TLP}$

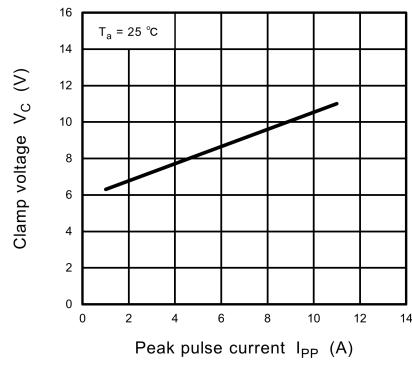
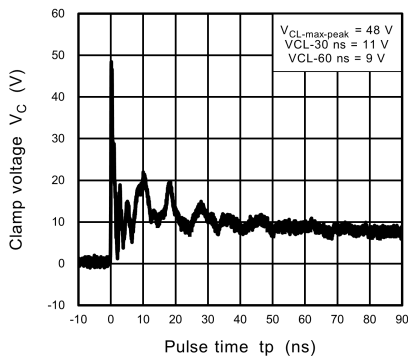
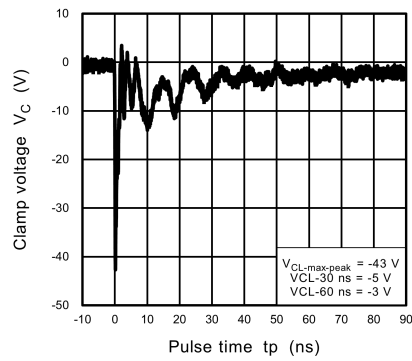

Fig. 10.3.2 $V_C - I_{PP}$



**Fig. 10.3.3 IEC61000-4-2
Clamp Waveform +8 kV**



**Fig. 10.3.4 IEC61000-4-2
Clamp Waveform -8 kV**

Note: The above characteristics curves are presented for reference only and not guaranteed by production test, unless otherwise noted.

Refer to Fig.10.22.1, Fig.10.22.2 for peak pulse current($V_C - I_{PP}$) and clamp waveform measurement circuit.

10.4. CUZ6V8 Characteristics Curves(Note)

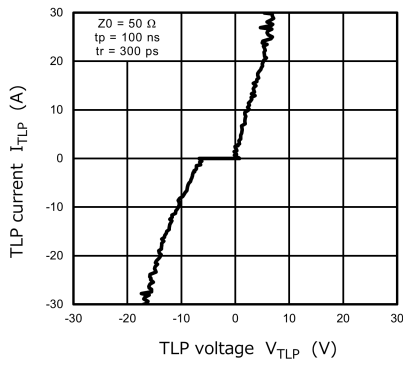

Fig. 10.4.1 $I_{TLP} - V_{TLP}$

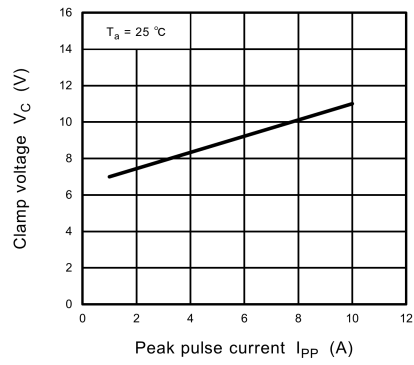

Fig. 10.4.2 $V_C - I_{PP}$

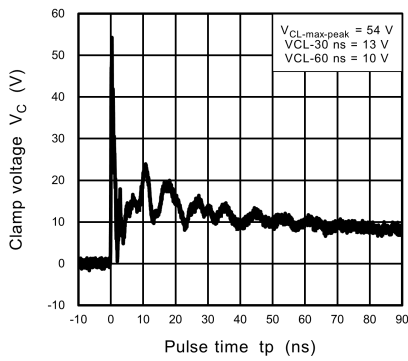

Fig. 10.4.3 IEC61000-4-2
Clamp Waveform +8 kV

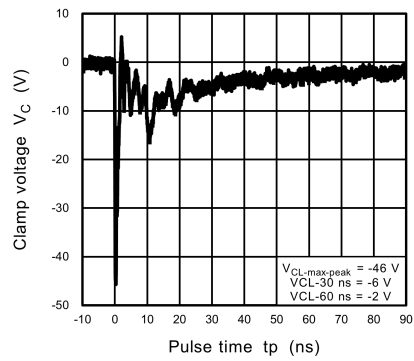

Fig. 10.4.4 IEC61000-4-2
Clamp Waveform -8 kV

Note: The above characteristics curves are presented for reference only and not guaranteed by production test, unless otherwise noted.

Refer to Fig.10.22.1, Fig.10.22.2 for peak pulse current(V_C-I_{PP}) and clamp waveform measurement circuit.

10.5. CUZ7V5 Characteristics Curves(Note)

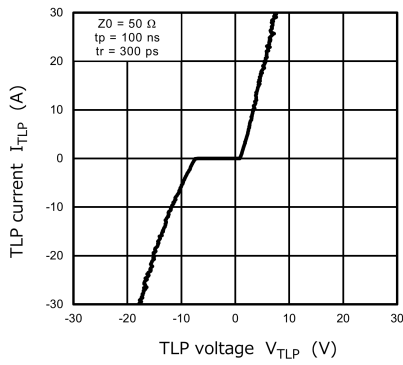

Fig. 10.5.1 $I_{TLP} - V_{TLP}$

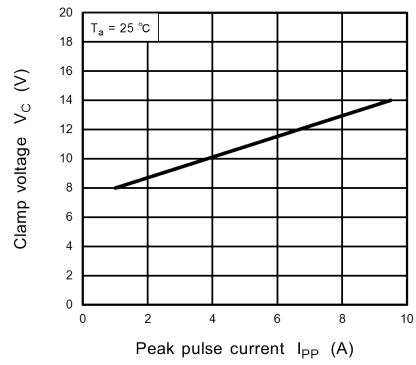
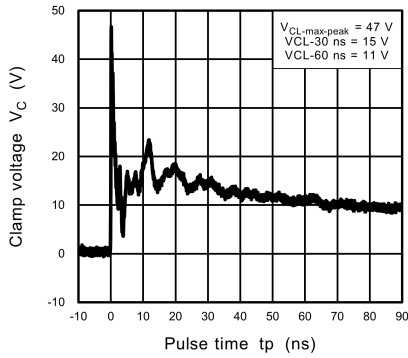
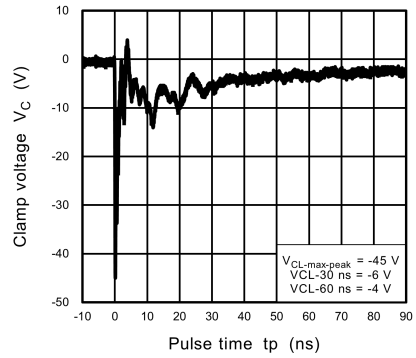

Fig. 10.5.2 $V_C - I_{PP}$



**Fig. 10.5.3 IEC61000-4-2
Clamp Waveform +8 kV**



**Fig. 10.5.4 IEC61000-4-2
Clamp Waveform -8 kV**

Note: The above characteristics curves are presented for reference only and not guaranteed by production test, unless otherwise noted.

Refer to Fig.10.22.1, Fig.10.22.2 for peak pulse current(V_C-I_{PP}) and clamp waveform measurement circuit.

10.6. CUZ8V2 Characteristics Curves(Note)

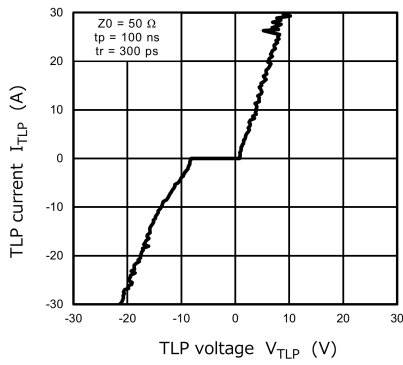

Fig. 10.6.1 $I_{TLP} - V_{TLP}$

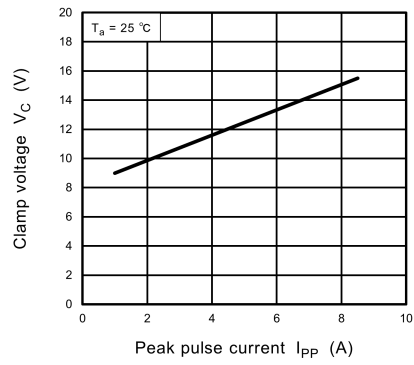
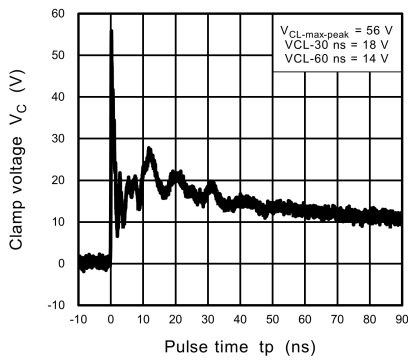
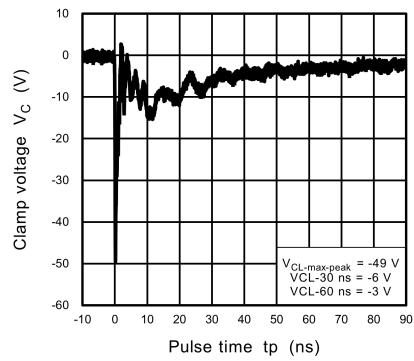

Fig. 10.6.2 $V_C - I_{PP}$



**Fig. 10.6.3 IEC61000-4-2
Clamp Waveform +8 kV**



**Fig. 10.6.4 IEC61000-4-2
Clamp Waveform -8 kV**

Note: The above characteristics curves are presented for reference only and not guaranteed by production test, unless otherwise noted.

Refer to Fig.10.22.1, Fig.10.22.2 for peak pulse current(V_C-I_{PP}) and clamp waveform measurement circuit.

10.7. CUZ9V1 Characteristics Curves(Note)

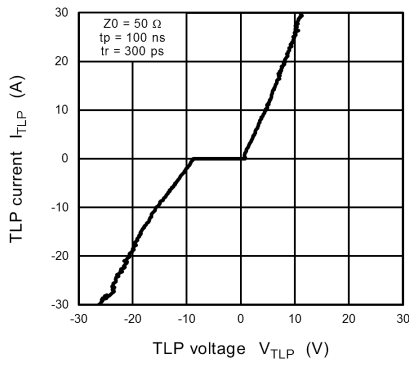

Fig. 10.7.1 $I_{TLP} - V_{TLP}$

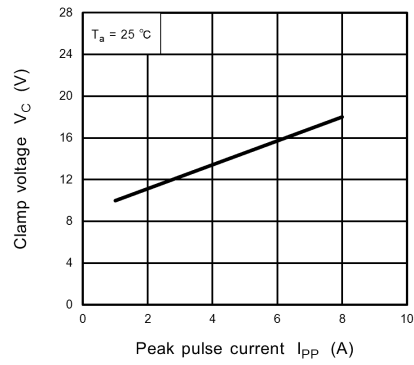
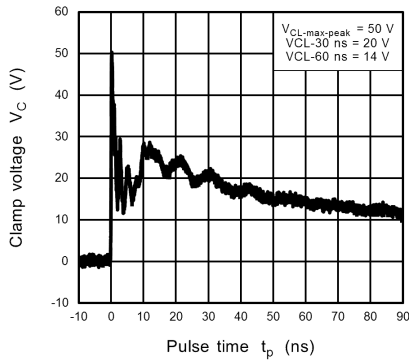
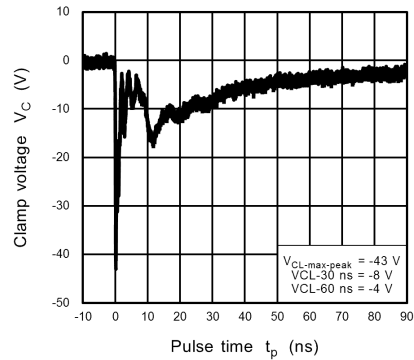

Fig. 10.7.2 $V_C - I_{PP}$



**Fig. 10.7.3 IEC61000-4-2
Clamp Waveform +8 kV**



**Fig. 10.7.4 IEC61000-4-2
Clamp Waveform -8 kV**

Note: The above characteristics curves are presented for reference only and not guaranteed by production test, unless otherwise noted.

Refer to Fig.10.22.1, Fig.10.22.2 for peak pulse current(V_C-I_{PP}) and clamp waveform measurement circuit.

10.8. CUZ10V Characteristics Curves(Note)

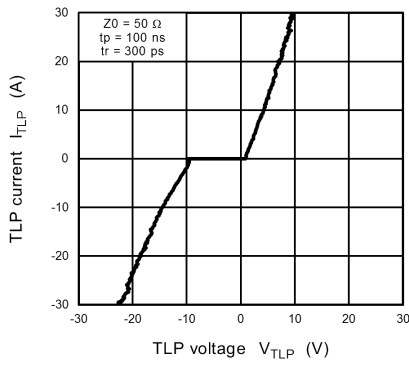

Fig. 10.8.1 $I_{TLP} - V_{TLP}$

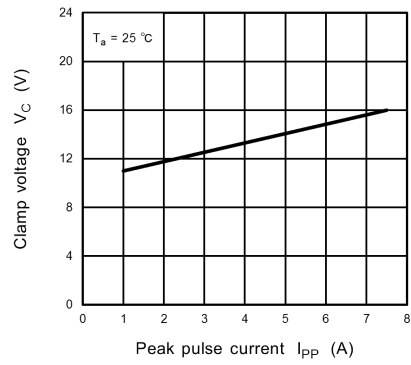

Fig. 10.8.2 $V_C - I_{PP}$

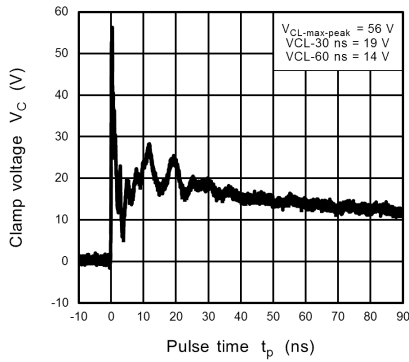

Fig. 10.8.3 IEC61000-4-2
Clamp Waveform +8 kV

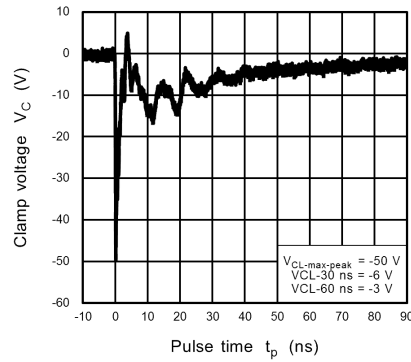

Fig. 10.8.4 IEC61000-4-2
Clamp Waveform -8 kV

Note: The above characteristics curves are presented for reference only and not guaranteed by production test, unless otherwise noted.

Refer to Fig.10.22.1, Fig.10.22.2 for peak pulse current(V_C-I_{PP}) and clamp waveform measurement circuit.

10.9. CUZ11V Characteristics Curves(Note)

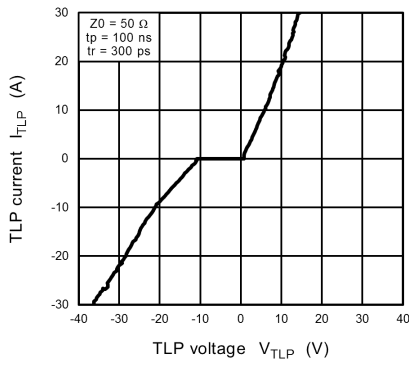

Fig. 10.9.1 $I_{TLP} - V_{TLP}$

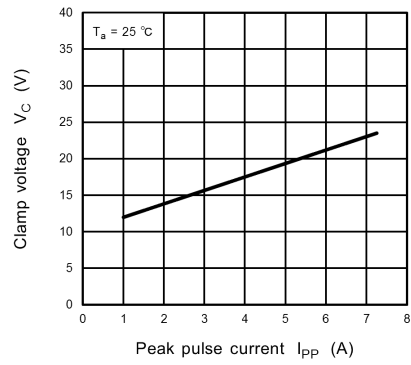
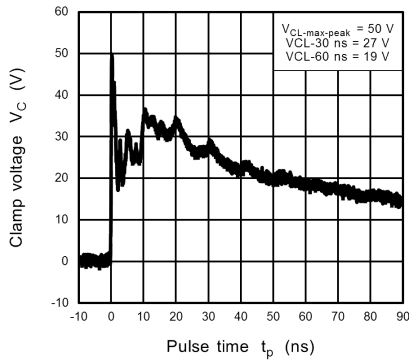
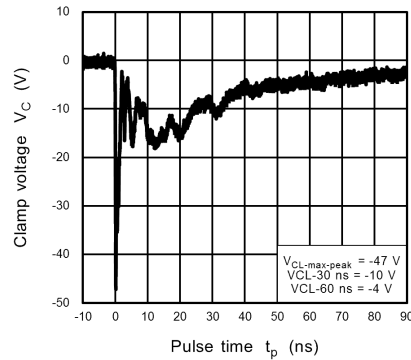

Fig. 10.9.2 $V_C - I_{PP}$



**Fig. 10.9.3 IEC61000-4-2
Clamp Waveform +8 kV**



**Fig. 10.9.4 IEC61000-4-2
Clamp Waveform -8 kV**

Note: The above characteristics curves are presented for reference only and not guaranteed by production test, unless otherwise noted.

Refer to Fig.10.22.1, Fig.10.22.2 for peak pulse current(V_C-I_{PP}) and clamp waveform measurement circuit.

10.10. CUZ12V Characteristics Curves(Note)

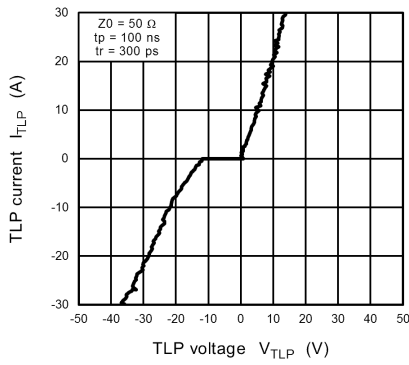

Fig. 10.10.1 $I_{TLP} - V_{TLP}$

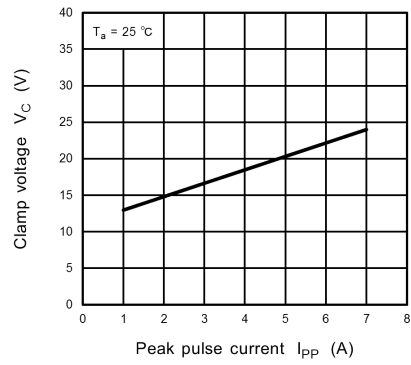
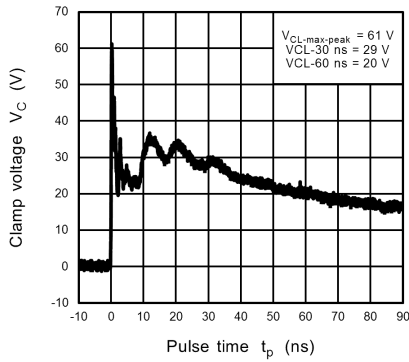
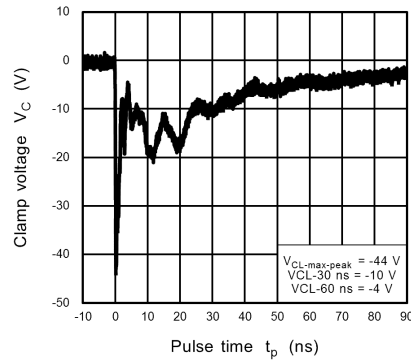

Fig. 10.10.2 $V_C - I_{PP}$



**Fig. 10.10.3 IEC61000-4-2
Clamp Waveform +8 kV**



**Fig. 10.10.4 IEC61000-4-2
Clamp Waveform -8 kV**

Note: The above characteristics curves are presented for reference only and not guaranteed by production test, unless otherwise noted.

Refer to Fig.10.22.1, Fig.10.22.2 for peak pulse current(V_C-I_{PP}) and clamp waveform measurement circuit.

10.11. CUZ13V Characteristics Curves(Note)

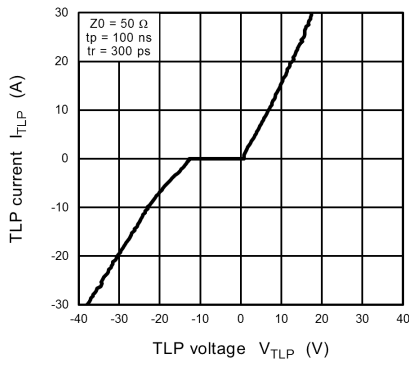

Fig. 10.11.1 $I_{TLP} - V_{TLP}$

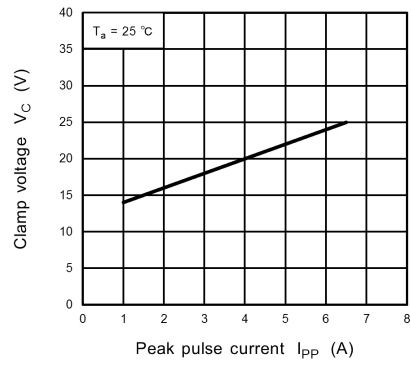
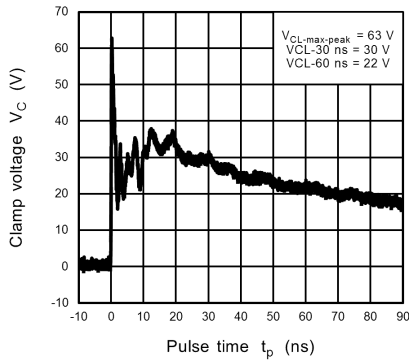
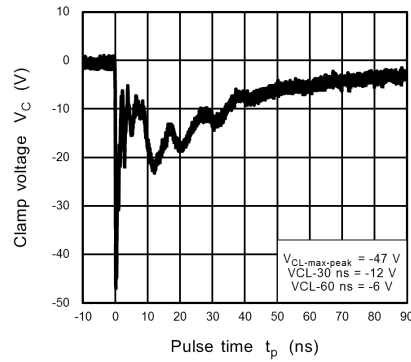

Fig. 10.11.2 $V_C - I_{PP}$



**Fig. 10.11.3 IEC61000-4-2
Clamp Waveform +8 kV**



**Fig. 10.11.4 IEC61000-4-2
Clamp Waveform -8 kV**

Note: The above characteristics curves are presented for reference only and not guaranteed by production test, unless otherwise noted.

Refer to Fig.10.22.1, Fig.10.22.2 for peak pulse current($V_C - I_{PP}$) and clamp waveform measurement circuit.

10.12. CUZ15V Characteristics Curves(Note)

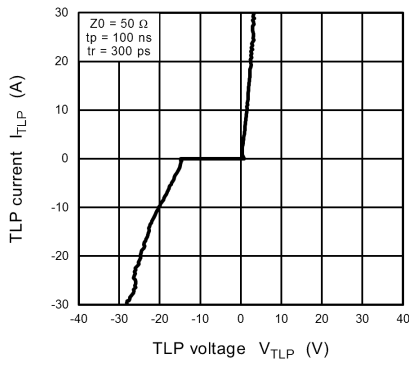

Fig. 10.12.1 $I_{TLP} - V_{TLP}$

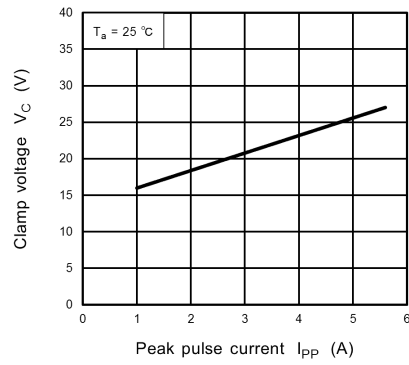
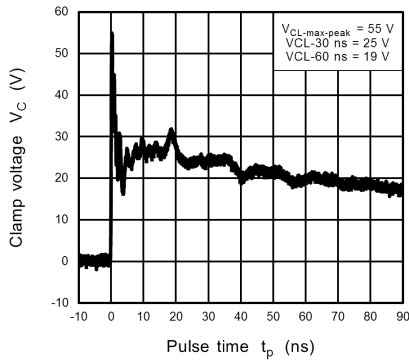
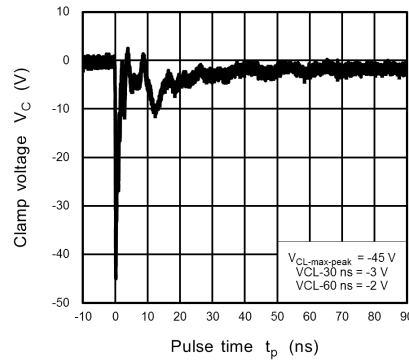

Fig. 10.12.2 $V_C - I_{PP}$



**Fig. 10.12.3 IEC61000-4-2
Clamp Waveform +8 kV**



**Fig. 10.12.4 IEC61000-4-2
Clamp Waveform -8 kV**

Note: The above characteristics curves are presented for reference only and not guaranteed by production test, unless otherwise noted.

Refer to Fig.10.22.1, Fig.10.22.2 for peak pulse current(V_C-I_{PP}) and clamp waveform measurement circuit.

10.13. CUZ16V Characteristics Curves(Note)

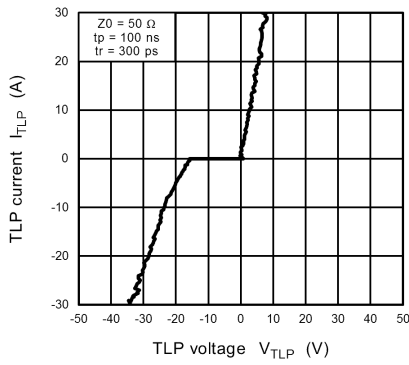

Fig. 10.13.1 $I_{TLP} - V_{TLP}$

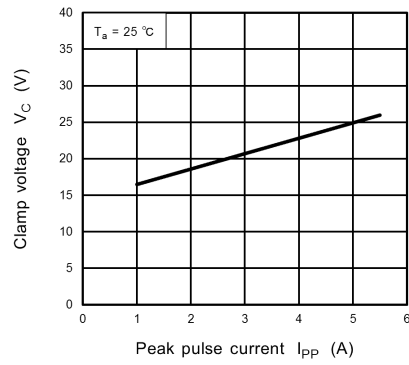
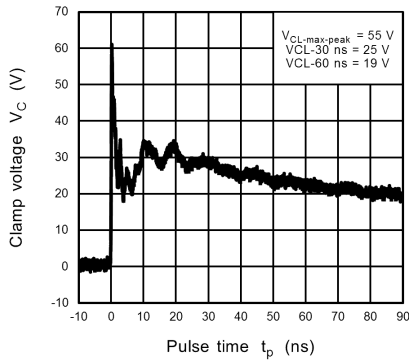
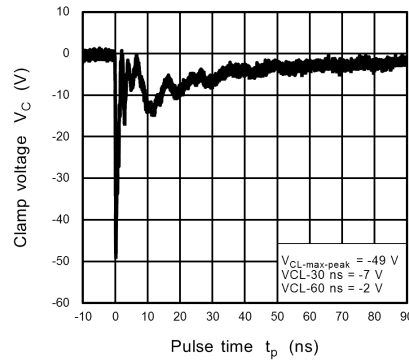

Fig. 10.13.2 $V_C - I_{PP}$



**Fig. 10.13.3 IEC61000-4-2
Clamp Waveform +8 kV**



**Fig. 10.13.4 IEC61000-4-2
Clamp Waveform -8 kV**

Note: The above characteristics curves are presented for reference only and not guaranteed by production test, unless otherwise noted.

Refer to Fig.10.22.1, Fig.10.22.2 for peak pulse current(V_C-I_{PP}) and clamp waveform measurement circuit.

10.14. CUZ18V Characteristics Curves(Note)

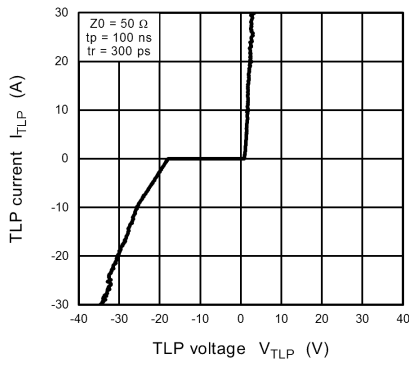

Fig. 10.14.1 $I_{TLP} - V_{TLP}$

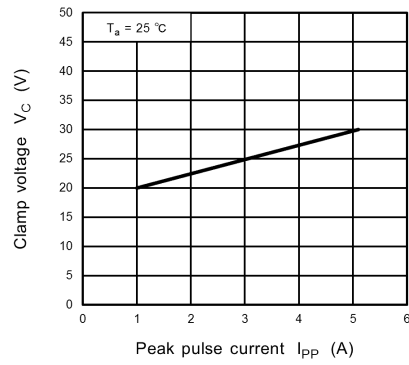

Fig. 10.14.2 $V_C - I_{PP}$

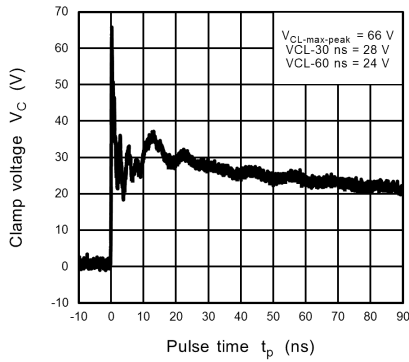

Fig. 10.14.3 IEC61000-4-2
Clamp Waveform +8 kV

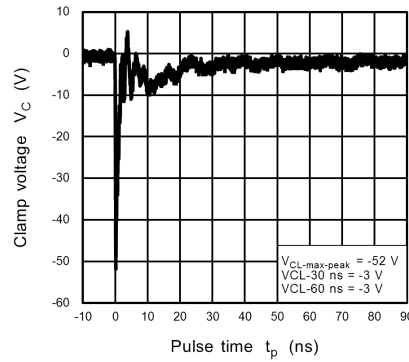

Fig. 10.14.4 IEC61000-4-2
Clamp Waveform -8 kV

Note: The above characteristics curves are presented for reference only and not guaranteed by production test, unless otherwise noted.

Refer to Fig.10.22.1, Fig.10.22.2 for peak pulse current(V_C-I_{PP}) and clamp waveform measurement circuit.

10.15. CUZ20V Characteristics Curves(Note)

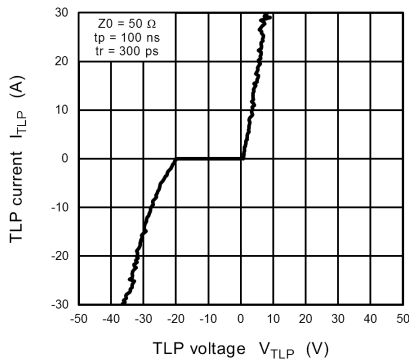

Fig. 10.15.1 $I_{TLP} - V_{TLP}$

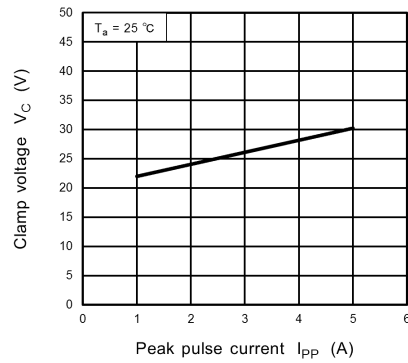
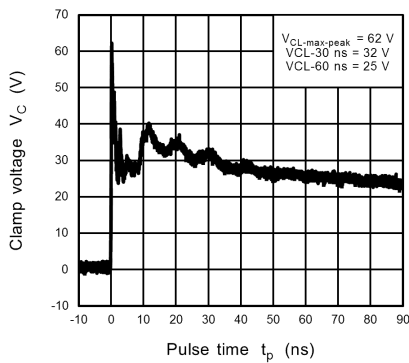
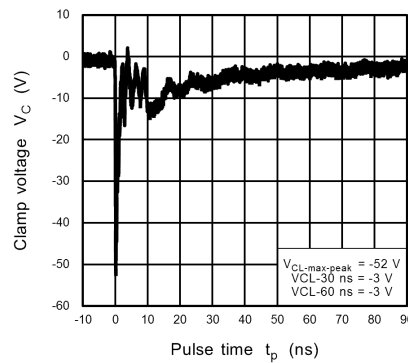

Fig. 10.15.2 $V_C - I_{PP}$



**Fig. 10.15.3 IEC61000-4-2
Clamp Waveform +8 kV**



**Fig. 10.15.4 IEC61000-4-2
Clamp Waveform -8 kV**

Note: The above characteristics curves are presented for reference only and not guaranteed by production test, unless otherwise noted.

Refer to Fig.10.22.1, Fig.10.22.2 for peak pulse current(V_C-I_{PP}) and clamp waveform measurement circuit.

10.16. CUZ22V Characteristics Curves(Note)

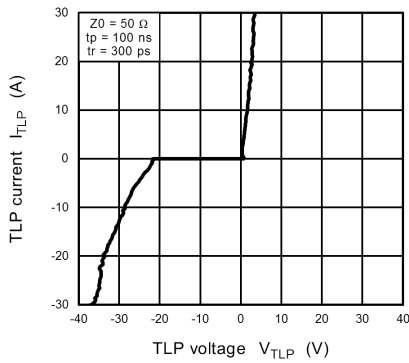

Fig. 10.16.1 $I_{TLP} - V_{TLP}$

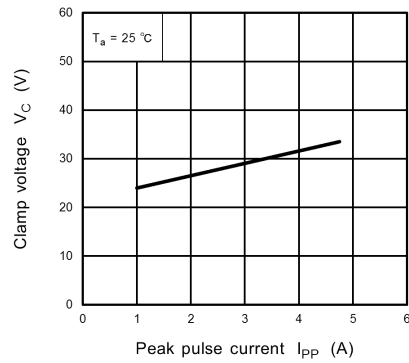
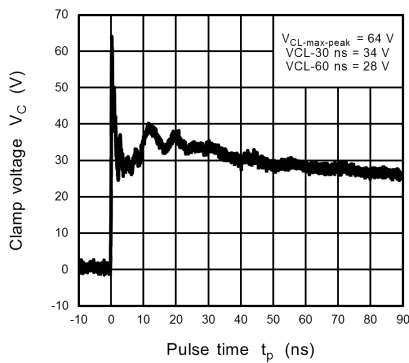
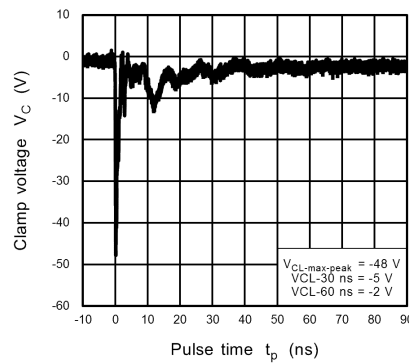

Fig. 10.16.2 $V_C - I_{PP}$



**Fig. 10.16.3 IEC61000-4-2
Clamp Waveform +8 kV**



**Fig. 10.16.4 IEC61000-4-2
Clamp Waveform -8 kV**

Note: The above characteristics curves are presented for reference only and not guaranteed by production test, unless otherwise noted.

Refer to Fig.10.22.1, Fig.10.22.2 for peak pulse current($V_C - I_{PP}$) and clamp waveform measurement circuit.

10.17. CUZ24V Characteristics Curves(Note)

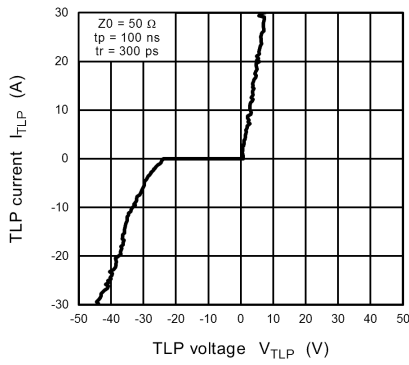

Fig. 10.17.1 $I_{TLP} - V_{TLP}$

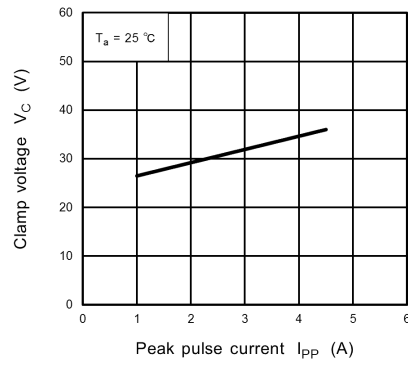
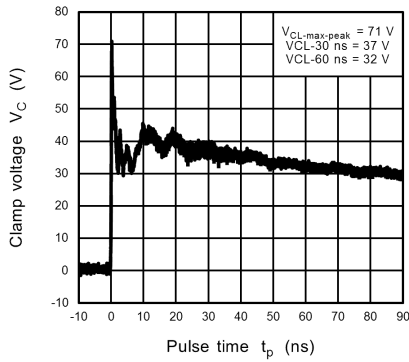
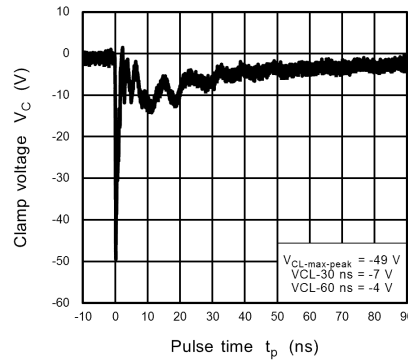

Fig. 10.17.2 $V_C - I_{PP}$



**Fig. 10.17.3 IEC61000-4-2
Clamp Waveform +8 kV**



**Fig. 10.17.4 IEC61000-4-2
Clamp Waveform -8 kV**

Note: The above characteristics curves are presented for reference only and not guaranteed by production test, unless otherwise noted.

Refer to Fig.10.22.1, Fig.10.22.2 for peak pulse current(V_C-I_{PP}) and clamp waveform measurement circuit.

10.18. CUZ27V Characteristics Curves(Note)

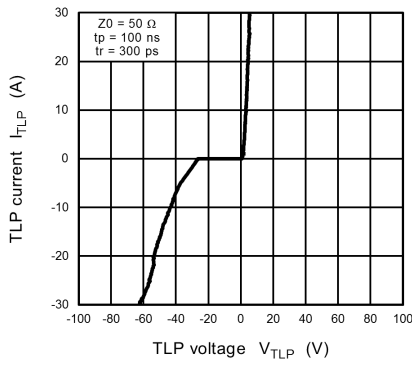

Fig. 10.18.1 $I_{TLP} - V_{TLP}$

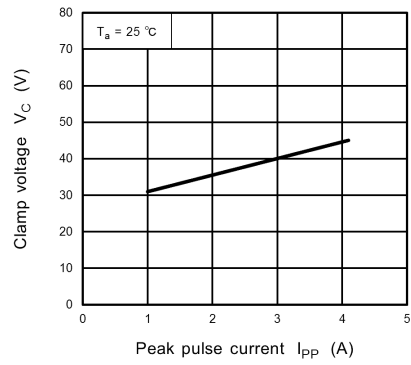
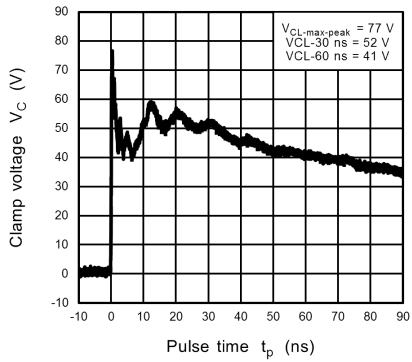
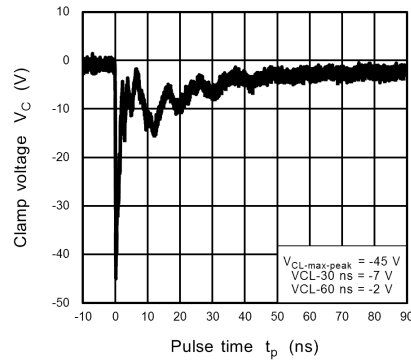

Fig. 10.18.2 $V_C - I_{PP}$



**Fig. 10.18.3 IEC61000-4-2
Clamp Waveform +8 kV**



**Fig. 10.18.4 IEC61000-4-2
Clamp Waveform -8 kV**

Note: The above characteristics curves are presented for reference only and not guaranteed by production test, unless otherwise noted.

Refer to Fig.10.22.1, Fig.10.22.2 for peak pulse current($V_C - I_{PP}$) and clamp waveform measurement circuit.

10.19. CUZ30V Characteristics Curves(Note)

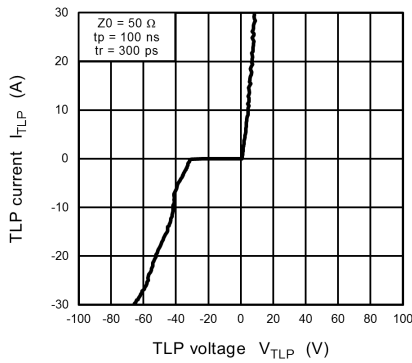

Fig. 10.19.1 $I_{TLP} - V_{TLP}$

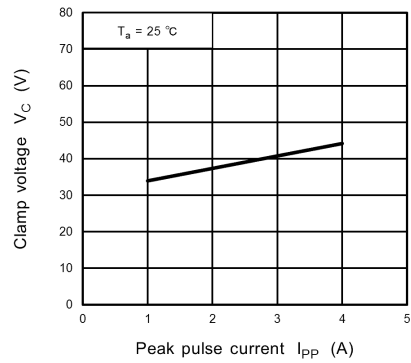

Fig. 10.19.2 $V_C - I_{PP}$

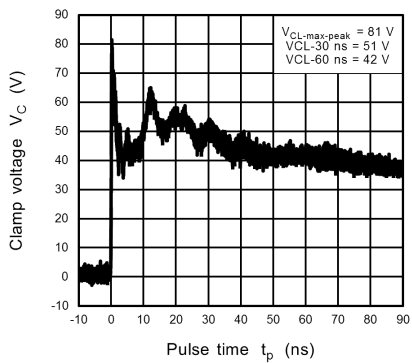

Fig. 10.19.3 IEC61000-4-2
Clamp Waveform +8 kV

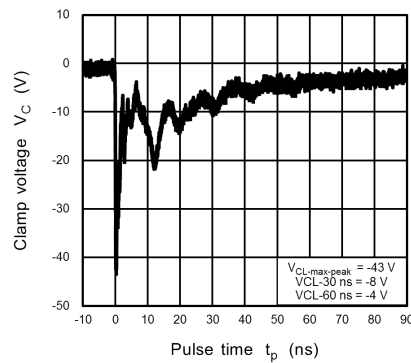

Fig. 10.19.4 IEC61000-4-2
Clamp Waveform -8 kV

Note: The above characteristics curves are presented for reference only and not guaranteed by production test, unless otherwise noted.

Refer to Fig.10.22.1, Fig.10.22.2 for peak pulse current(V_C-I_{PP}) and clamp waveform measurement circuit.

10.20. CUZ33V Characteristics Curves(Note)

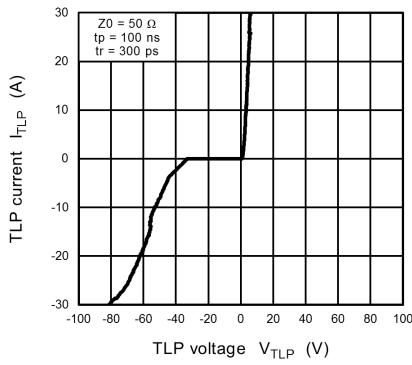

Fig. 10.20.1 $I_{TLP} - V_{TLP}$

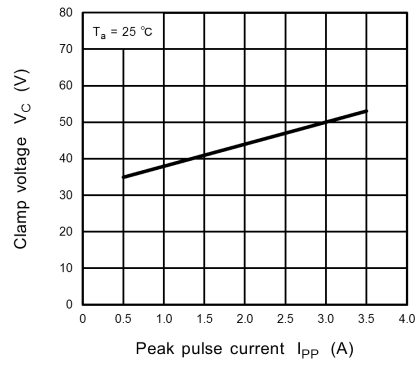
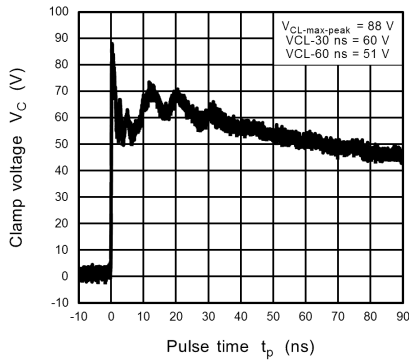
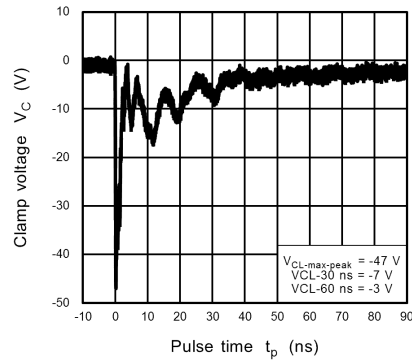

Fig. 10.20.2 $V_C - I_{PP}$



**Fig. 10.20.3 IEC61000-4-2
Clamp Waveform +8 kV**



**Fig. 10.20.4 IEC61000-4-2
Clamp Waveform -8 kV**

Note: The above characteristics curves are presented for reference only and not guaranteed by production test, unless otherwise noted.

Refer to Fig.10.22.1, Fig.10.22.2 for peak pulse current(V_C-I_{PP}) and clamp waveform measurement circuit.

10.21. CUZ36V Characteristics Curves(Note)

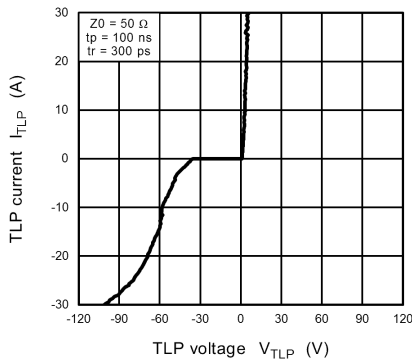

Fig. 10.21.1 $I_{TLP} - V_{TLP}$

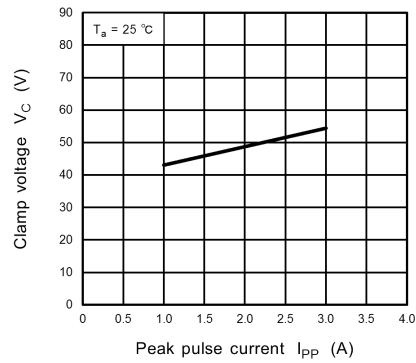

Fig. 10.21.2 $V_C - I_{PP}$

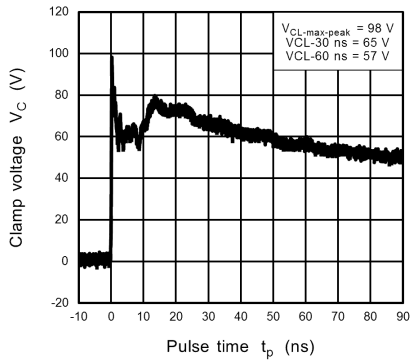

Fig. 10.21.3 IEC61000-4-2
Clamp Waveform +8 kV

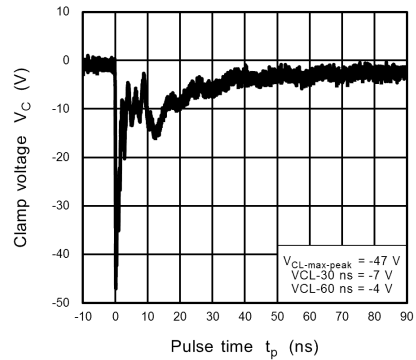

Fig. 10.21.4 IEC61000-4-2
Clamp Waveform -8 kV

Note: The above characteristics curves are presented for reference only and not guaranteed by production test, unless otherwise noted.

Refer to Fig.10.22.1, Fig.10.22.2 for peak pulse current(V_C - I_{PP}) and clamp waveform measurement circuit.

10.22. V_C - I_{PP} Peak Pulse and Clamp waveform measurement circuit

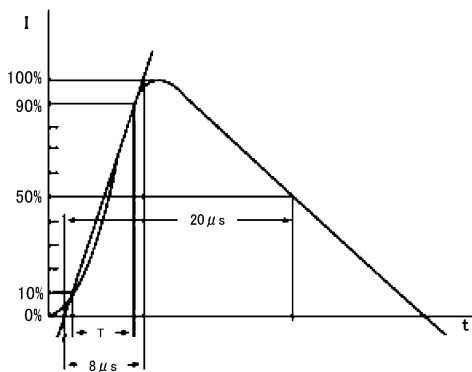

Fig. 10.22.1 V_C - I_{PP} Peak Pulse Current
(according to IEC61000-4-5 8/20 μs pulse)

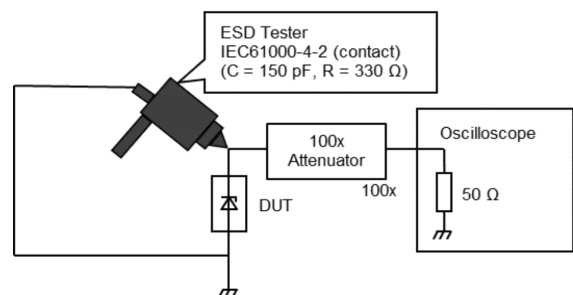
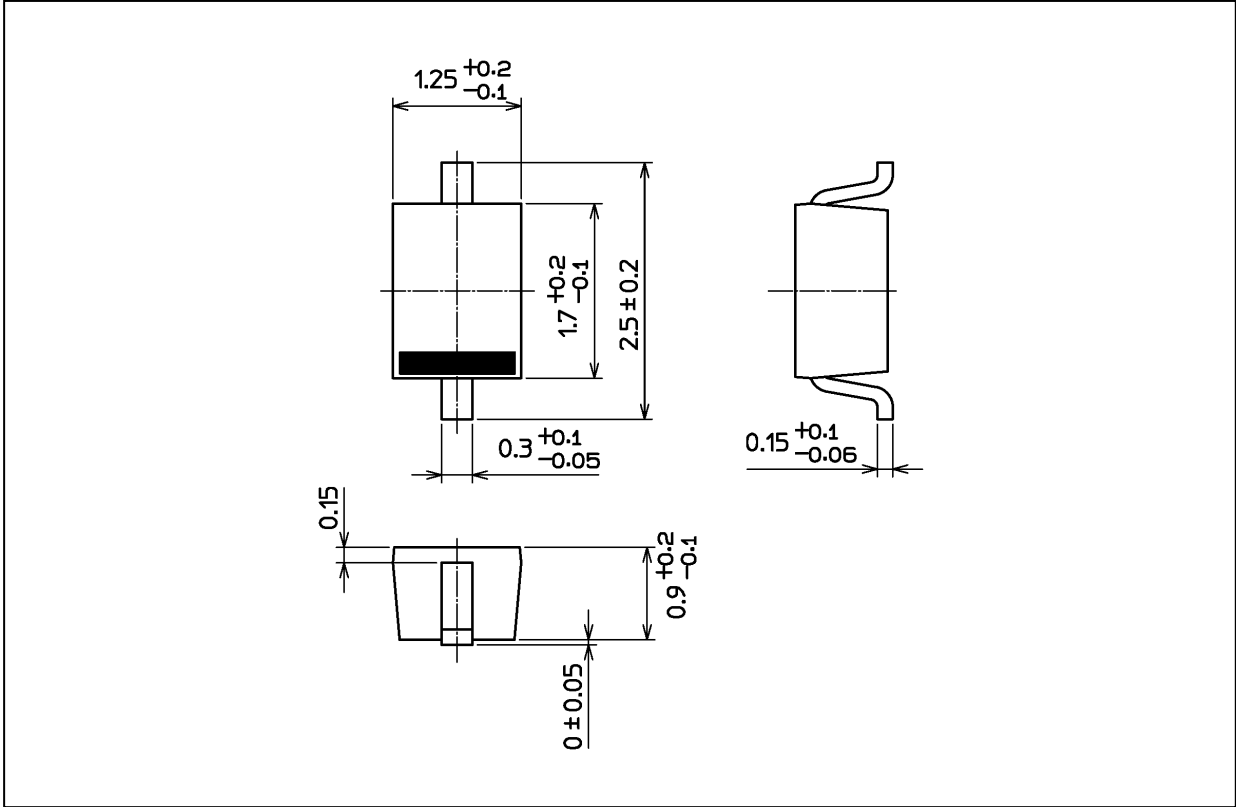

Fig. 10.22.2 Clamp waveform measurement
circuit (according to IEC61000-4-2)

Package Dimensions

Unit: mm



Weight: 4.5 mg (typ.)

Package Name(s)
Nickname: USC

RESTRICTIONS ON PRODUCT USE

Toshiba Corporation and its subsidiaries and affiliates are collectively referred to as "TOSHIBA".

Hardware, software and systems described in this document are collectively referred to as "Product".

- TOSHIBA reserves the right to make changes to the information in this document and related Product without notice.
- This document and any information herein may not be reproduced without prior written permission from TOSHIBA. Even with TOSHIBA's written permission, reproduction is permissible only if reproduction is without alteration/omission.
- Though TOSHIBA works continually to improve Product's quality and reliability, Product can malfunction or fail. Customers are responsible for complying with safety standards and for providing adequate designs and safeguards for their hardware, software and systems which minimize risk and avoid situations in which a malfunction or failure of Product could cause loss of human life, bodily injury or damage to property, including data loss or corruption. Before customers use the Product, create designs including the Product, or incorporate the Product into their own applications, customers must also refer to and comply with (a) the latest versions of all relevant TOSHIBA information, including without limitation, this document, the specifications, the data sheets and application notes for Product and the precautions and conditions set forth in the "TOSHIBA Semiconductor Reliability Handbook" and (b) the instructions for the application with which the Product will be used with or for. Customers are solely responsible for all aspects of their own product design or applications, including but not limited to (a) determining the appropriateness of the use of this Product in such design or applications; (b) evaluating and determining the applicability of any information contained in this document, or in charts, diagrams, programs, algorithms, sample application circuits, or any other referenced documents; and (c) validating all operating parameters for such designs and applications. **TOSHIBA ASSUMES NO LIABILITY FOR CUSTOMERS' PRODUCT DESIGN OR APPLICATIONS.**
- **PRODUCT IS NEITHER INTENDED NOR WARRANTED FOR USE IN EQUIPMENTS OR SYSTEMS THAT REQUIRE EXTRAORDINARILY HIGH LEVELS OF QUALITY AND/OR RELIABILITY, AND/OR A MALFUNCTION OR FAILURE OF WHICH MAY CAUSE LOSS OF HUMAN LIFE, BODILY INJURY, SERIOUS PROPERTY DAMAGE AND/OR SERIOUS PUBLIC IMPACT ("UNINTENDED USE").** Except for specific applications as expressly stated in this document, Unintended Use includes, without limitation, equipment used in nuclear facilities, equipment used in the aerospace industry, Class 3 medical devices, equipment used for automobiles, and military vehicles and munitions. **IF YOU USE PRODUCT FOR UNINTENDED USE, TOSHIBA ASSUMES NO LIABILITY FOR PRODUCT.** For details, please contact your TOSHIBA sales representative or contact us via our website.
- Do not disassemble, analyze, reverse-engineer, alter, modify, translate or copy Product, whether in whole or in part.
- Product shall not be used for or incorporated into any products or systems whose manufacture, use, or sale is prohibited under any applicable laws or regulations.
- The information contained herein is presented only as guidance for Product use. No responsibility is assumed by TOSHIBA for any infringement of patents or any other intellectual property rights of third parties that may result from the use of Product. No license to any intellectual property right is granted by this document, whether express or implied, by estoppel or otherwise.
- **ABSENT A WRITTEN SIGNED AGREEMENT, EXCEPT AS PROVIDED IN THE RELEVANT TERMS AND CONDITIONS OF SALE FOR PRODUCT, AND TO THE MAXIMUM EXTENT ALLOWABLE BY LAW, TOSHIBA (1) ASSUMES NO LIABILITY WHATSOEVER, INCLUDING WITHOUT LIMITATION, INDIRECT, CONSEQUENTIAL, SPECIAL, OR INCIDENTAL DAMAGES OR LOSS, INCLUDING WITHOUT LIMITATION, LOSS OF PROFITS, LOSS OF OPPORTUNITIES, BUSINESS INTERRUPTION AND LOSS OF DATA, AND (2) DISCLAIMS ANY AND ALL EXPRESS OR IMPLIED WARRANTIES AND CONDITIONS RELATED TO SALE, USE OF PRODUCT, OR INFORMATION, INCLUDING WARRANTIES OR CONDITIONS OF MERCHANTABILITY, FITNESS FOR A PARTICULAR PURPOSE, ACCURACY OF INFORMATION, OR NONINFRINGEMENT.**
- Do not use or otherwise make available Product or related software or technology for any military purposes, including without limitation, for the design, development, use, stockpiling or manufacturing of nuclear, chemical, or biological weapons or missile technology products (mass destruction weapons). Product and related software and technology may be controlled under the applicable export laws and regulations including, without limitation, the Japanese Foreign Exchange and Foreign Trade Law and the U.S. Export Administration Regulations. Export and re-export of Product or related software or technology are strictly prohibited except in compliance with all applicable export laws and regulations.
- Please contact your TOSHIBA sales representative for details as to environmental matters such as the RoHS compatibility of Product. Please use Product in compliance with all applicable laws and regulations that regulate the inclusion or use of controlled substances, including without limitation, the EU RoHS Directive. **TOSHIBA ASSUMES NO LIABILITY FOR DAMAGES OR LOSSES OCCURRING AS A RESULT OF NONCOMPLIANCE WITH APPLICABLE LAWS AND REGULATIONS.**