

Application Note

UART_TRANS (UART-C)

Arm and Keil are registered trademarks of Arm Limited (or its subsidiaries) in the US and/or elsewhere.

All other company names, product names, and service names mentioned herein may be trademarks of their respective companies.

Table of Contents

Table of Contents.....	2
1. Preface	3
2. Technical Term	3
3. Reference Document	3
4. Target Sample Program	4
5. Configuration Diagram	4
6. Sample Program:UART_TRANS.....	5
6.1. Outlines of Operation.....	5
6.2. Function to Use.....	5
6.3. Interrupt to Use	5
6.4. Configuration.....	5
6.5. Example of Terminal Emulator Output	5
6.6. How to switch DMAC function	6
6.6.1. IAR Embedded Workbench.....	6
6.6.2. Keil μ Vision.....	8
6.6.3. SEGGER Embedded Studio	10
7. Activity diagram.....	12
7.1. main	12
7.2. variable_initialize	15
7.3. driver_initialize	16
7.4. driver_finalize.....	17
7.5. driver_dma_initialize	17
7.6. driver_dma_finalize.....	18
7.7. application_initialize.....	19
7.8. application_finalize.....	20
7.9. uart_initialize	22
7.10. sw_state_change_handler.....	23
7.11. Interrupt.....	24
8. Revision History	26
RESTRICTIONS ON PRODUCT USE	27

1. Preface

This application note describes the sample software of UART_TRANS using Universal Asynchronous Receiver Transmitter (UART).

This document helps the user check operation of a product under development and develop its program.

2. Technical Term

Term/Abbreviation	Definition
BSP	Board Support Package
CG	Clock Control and Operation Mode
DMA	Direct Memory Access
Timer	T32A:32-bit Timer Event Counter
UART	Universal Asynchronous Receiver Transmitter

3. Reference Document

Document	Notes
Data sheet	Refer to the data sheet of MCU to be used.
Reference manual	Refer to the reference manual of each IP to be used.
Application note MCU User Guide	Refer to the MCU user guide to be used.

4. Target Sample Program

Sample Program	Outline
UART_TRANS	Sample program of UART function (UART Trans)

5. Configuration Diagram

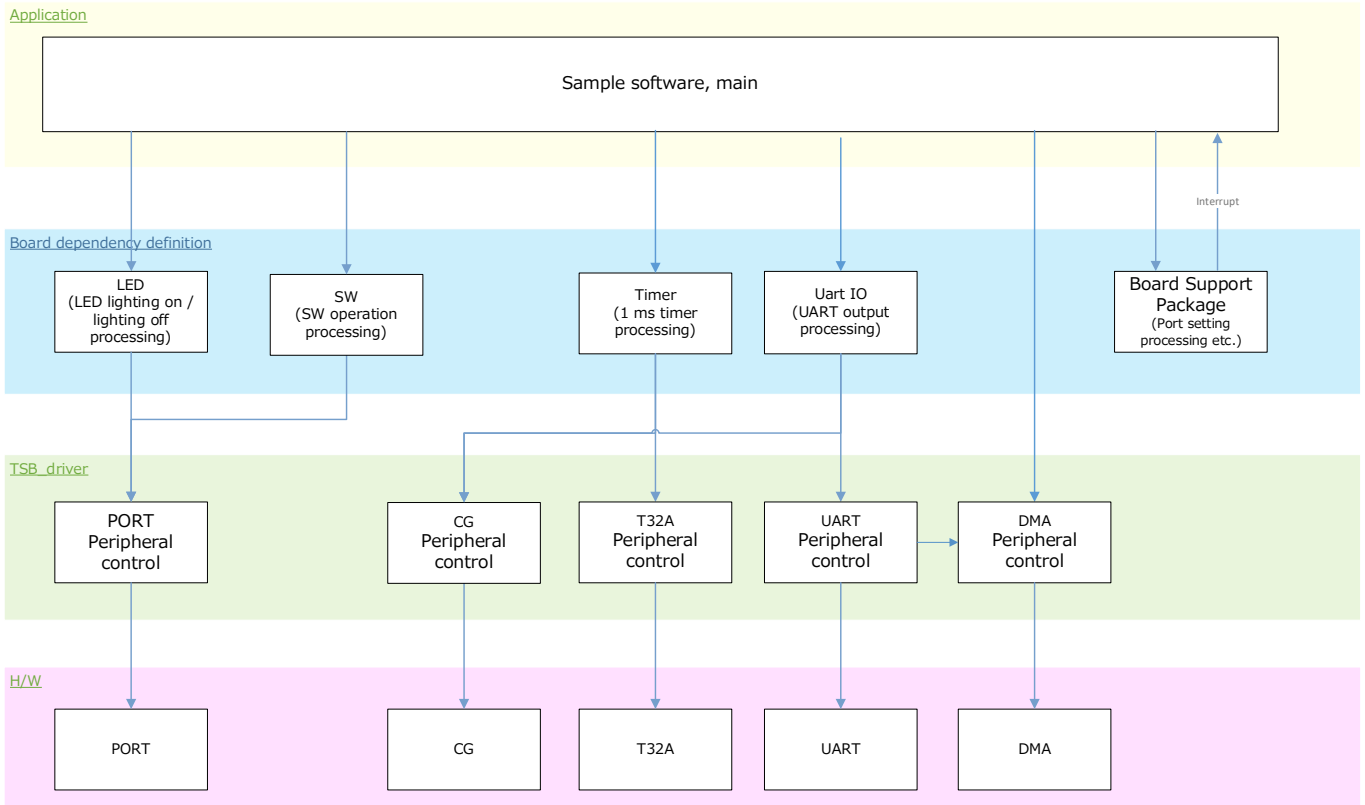

6. Sample Program:UART_TRANS

This sample software that uses the transmission function of the UART communication function to send logs to the terminal emulator triggered by pressing a switch, and switches the LED turn on / turn off for each UART transmission.

6.1. Outlines of Operation

Wait for BSP_PSW_1 to be pressed.

When BSP_PSW_1 is pressed, the log is transmitted by UART, BSP_LED_2 is turned on / off, and BSP_LED_3 is turned off.

When an error occurs, BSP_LED_3 is turn on.

6.2. Function to Use

The functions to use are as follows:

For the Port assignment of each BSP channel, refer to the MCU user guide.

IP	Channel	Objective
UART	BSP_UART_1	For terminal emulator communication
T32A	BSP_T32A_TIMER_1	Interval timer
PORT(Push-Switch)	BSP_PSW_1	Event Trigger
PORT(LED)	BSP_LED_2	For operation check
	BSP_LED_3	For operation check

6.3. Interrupt to Use

Interrupt	Outlines
INTT32A00A	T32A Timer A Timer counter increment every 1ms for switch processing
INTSC0TX Interrupt	UART transmit interrupt
INTSC0ERR Interrupt	UART error interrupt

6.4. Configuration

“main.c” configuration setting.

Configuration	Current Value	Description
Character string 1	*1	Character string to send
Communication control selection	*2 NODMAC	Switchable between NODMAC (does not use DMAC) and DMA (uses DMAC)

*1 For SBK-M4KN, "TMPM4KN \n"

*2 For details on how to switch when using DMAC, see Chapter 6.6.

6.5. Example of Terminal Emulator Output

Outputs the sent character string

```
TMPM4KN
TMPM4KN
```

6.6. How to switch DMAC function

Follow the steps below to enable/disable the DMAC function.

6.6.1. IAR Embedded Workbench

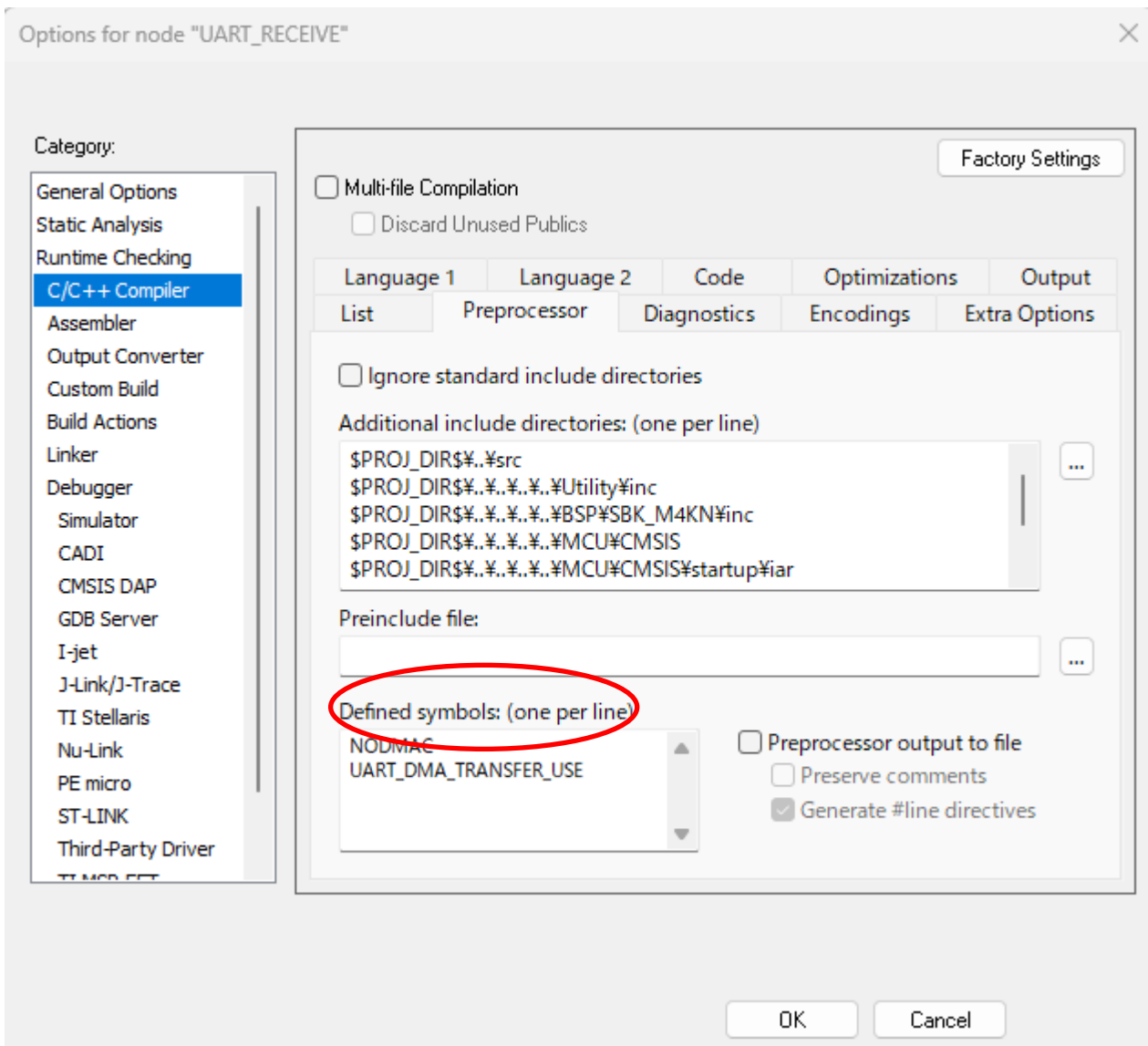

Open "Project" → "Options" → "C/C++ Compiler" → "Preprocessor".

Change "Defined symbol" as follows:

- If you do not use DMAC: "NODMAC"
- When using DMAC: "DMA"

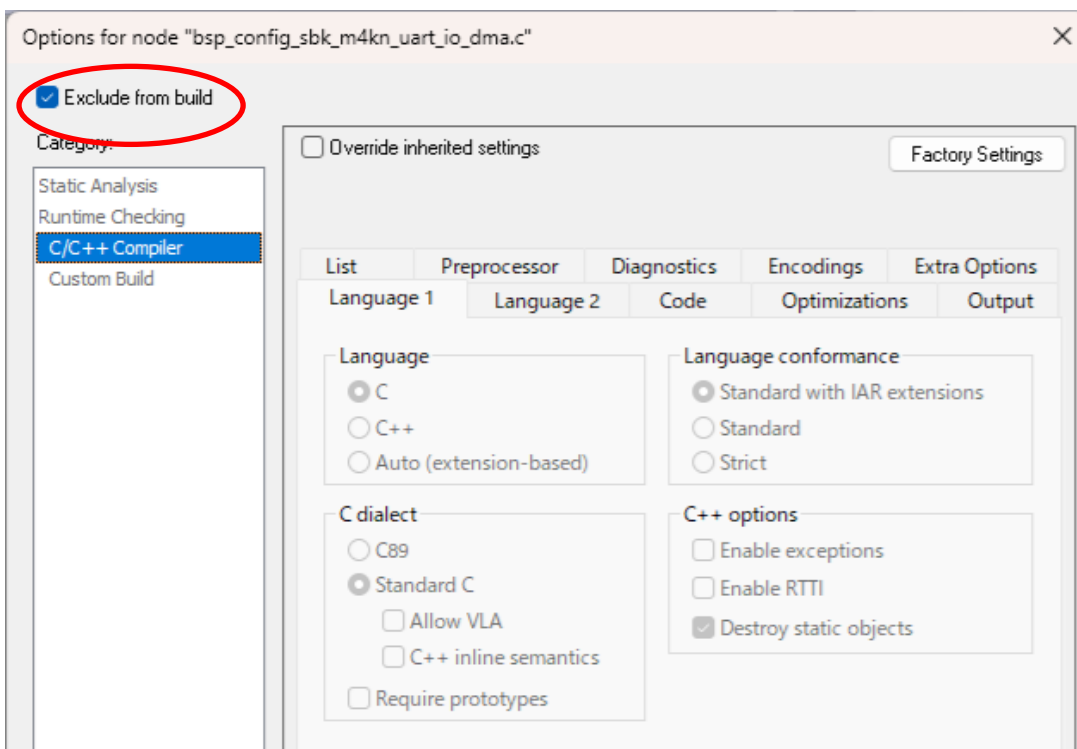
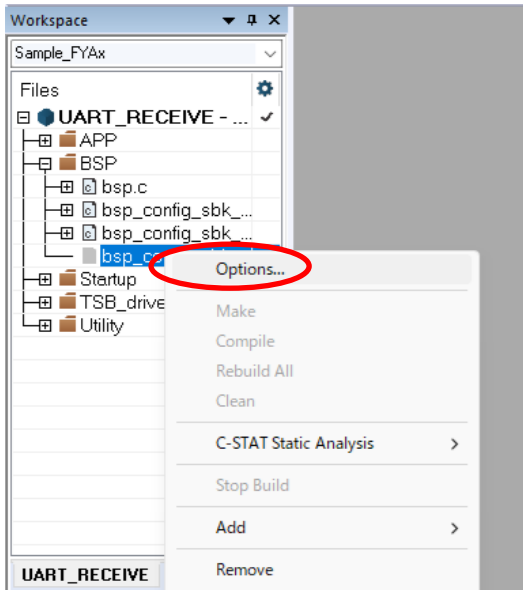

Right-click the file you want to configure, open options, and change "Exclude from build".
 If you want to use the file, uncheck "Exclude from build", otherwise uncheck "Exclude from build".

DMAC disabled:

bsp_config_sbkm4xn_uart_io.c	Use files
bsp_config_sbkm4xn_uart_io_dma.c	Don't use files

DMAC enabled:

bsp_config_sbkm4xn_uart_io.c	Don't use files
bsp_config_sbkm4xn_uart_io_dma.c	Use files

Please build after changing the settings.

6.6.2. Keil µVision

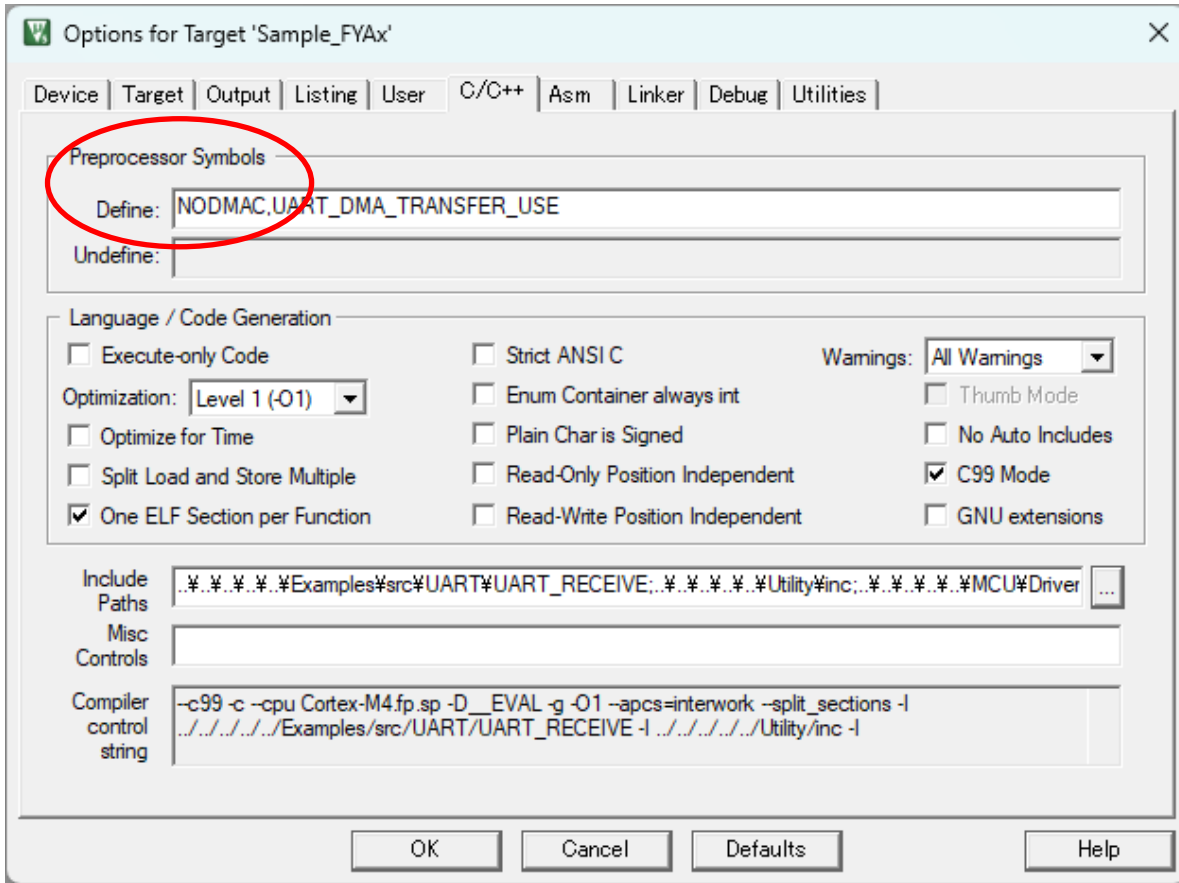

Open “Project” → “Options for Target ‘Sample’ ” → “C/C++” .
 Change "Define:" of "Preprocessor Symbols" as shown below.

- If you do not use DMAC, select "NODMAC"
- "DMA" when using DMAC

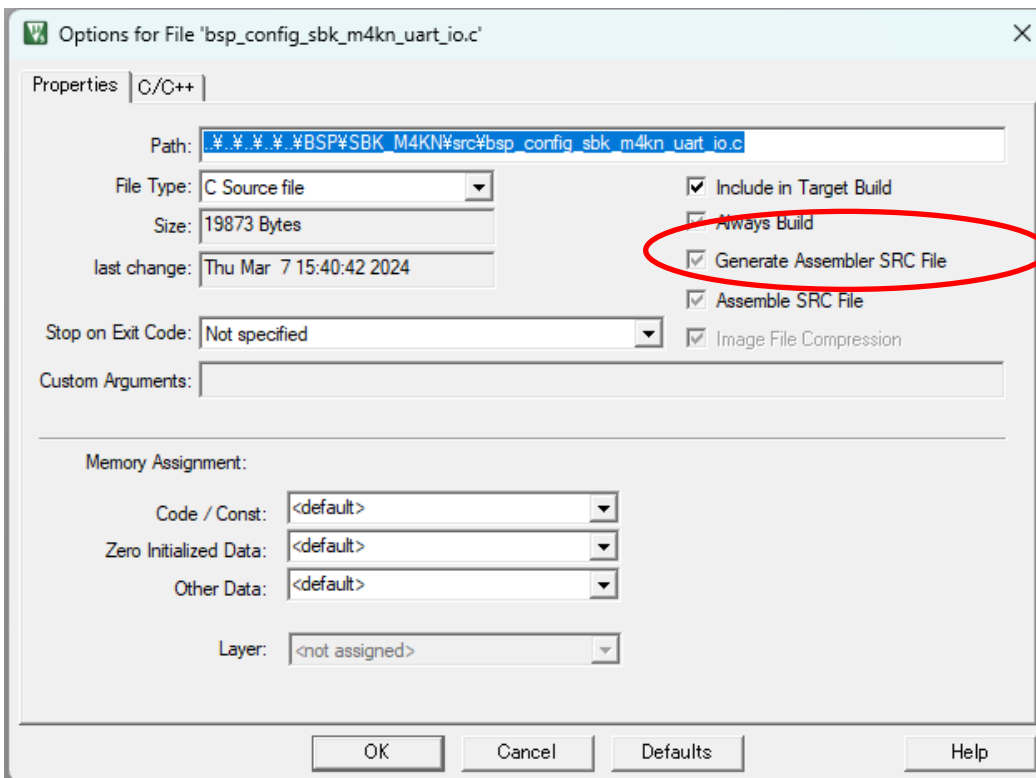
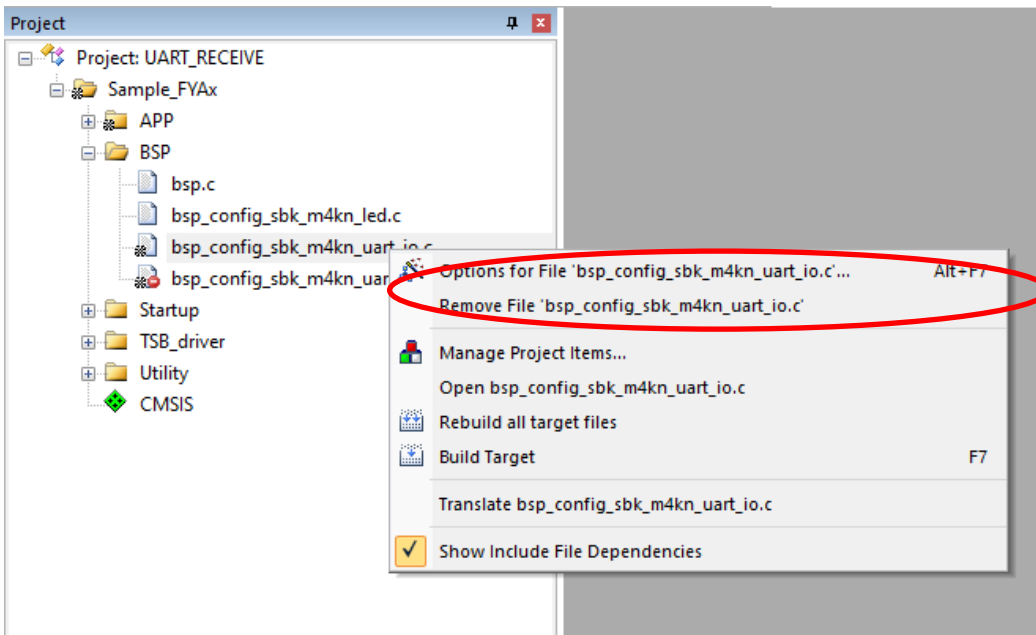

Right-click the file you want to configure, open Options for File 'xxxx.c' and change "Include in Target Build". If you want to use the file, check "Include in Target Build", otherwise uncheck "Include in Target Build".

DMAC disabled:

bsp_config_sbk_m4xn_uart_io.c	Use files
bsp_config_sbk_m4xn_uart_io_dma.c	Don't use files

DMAC enabled:

bsp_config_sbk_m4xn_uart_io.c	Don't use files
bsp_config_sbk_m4xn_uart_io_dma.c	Use files

Please build after changing the settings.

6.6.3. SEGGER Embedded Studio

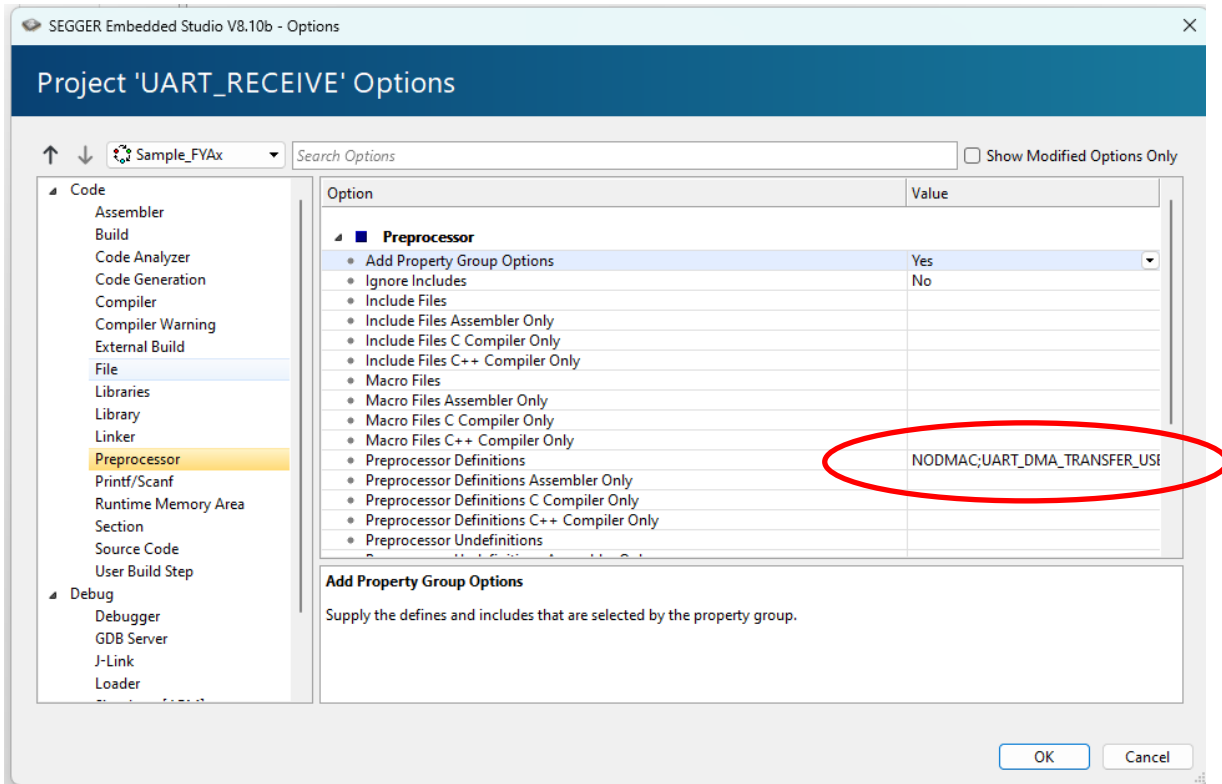

- Open "Project" → "Options" → "Preprocessor".
 Change "Preprocessor Definitions" as shown below.
- If you do not use DMAC, select "NODMAC"
 - "DMA" when using DMAC

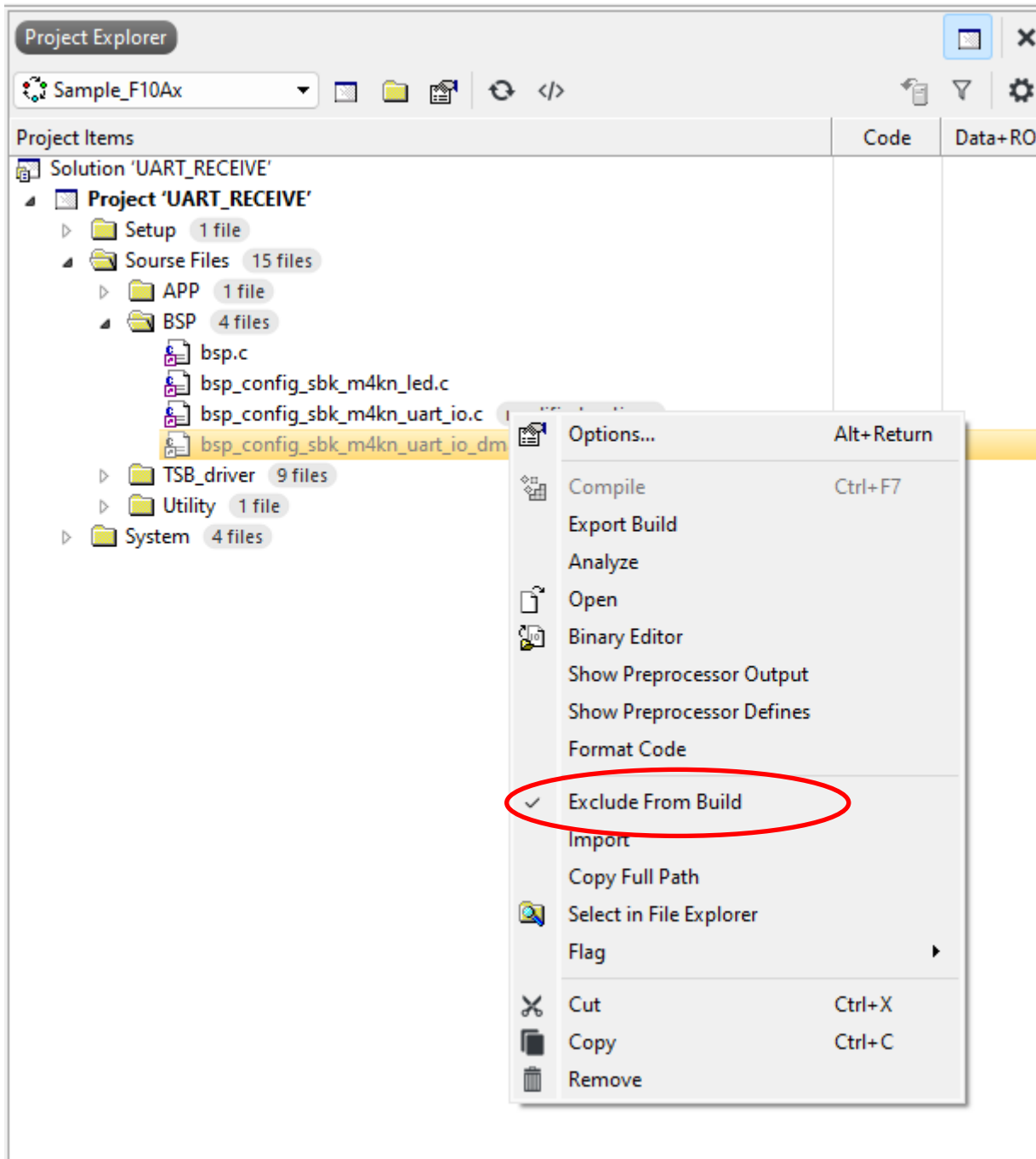

Right-click the file you want to configure and change "Exclude From Build".
 If you want to use a file, uncheck "Exclude From Build", otherwise check "Exclude From Build".

DMAC disabled:

bsp_config_sbk_m4xn_uart_io.c	Use files
bsp_config_sbk_m4xn_uart_io_dma.c	Don't use files

DMAC enabled:

bsp_config_sbk_m4xn_uart_io.c	Don't use files
bsp_config_sbk_m4xn_uart_io_dma.c	Use files

Please build after changing the settings.

7. Activity diagram

7.1. main

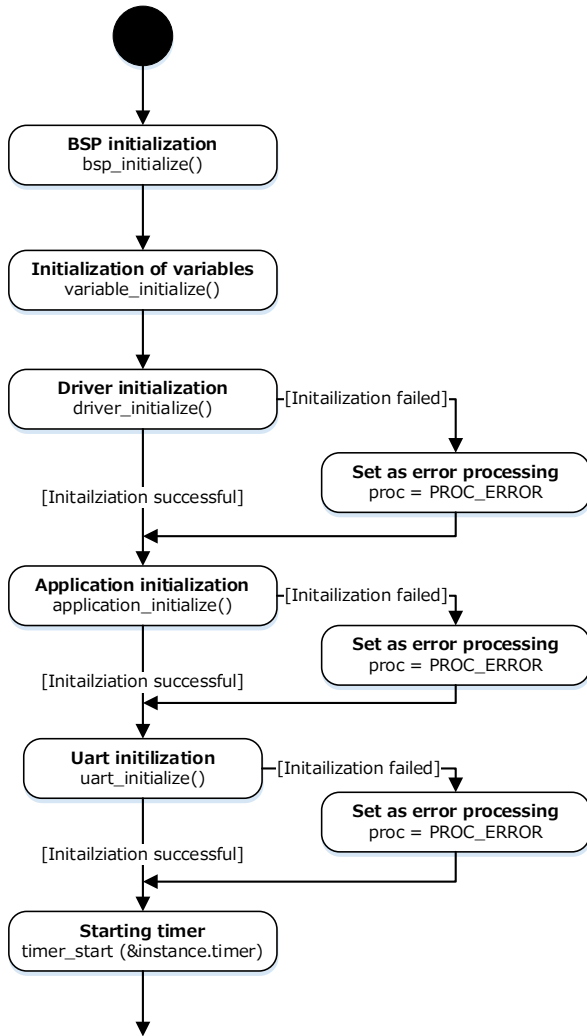

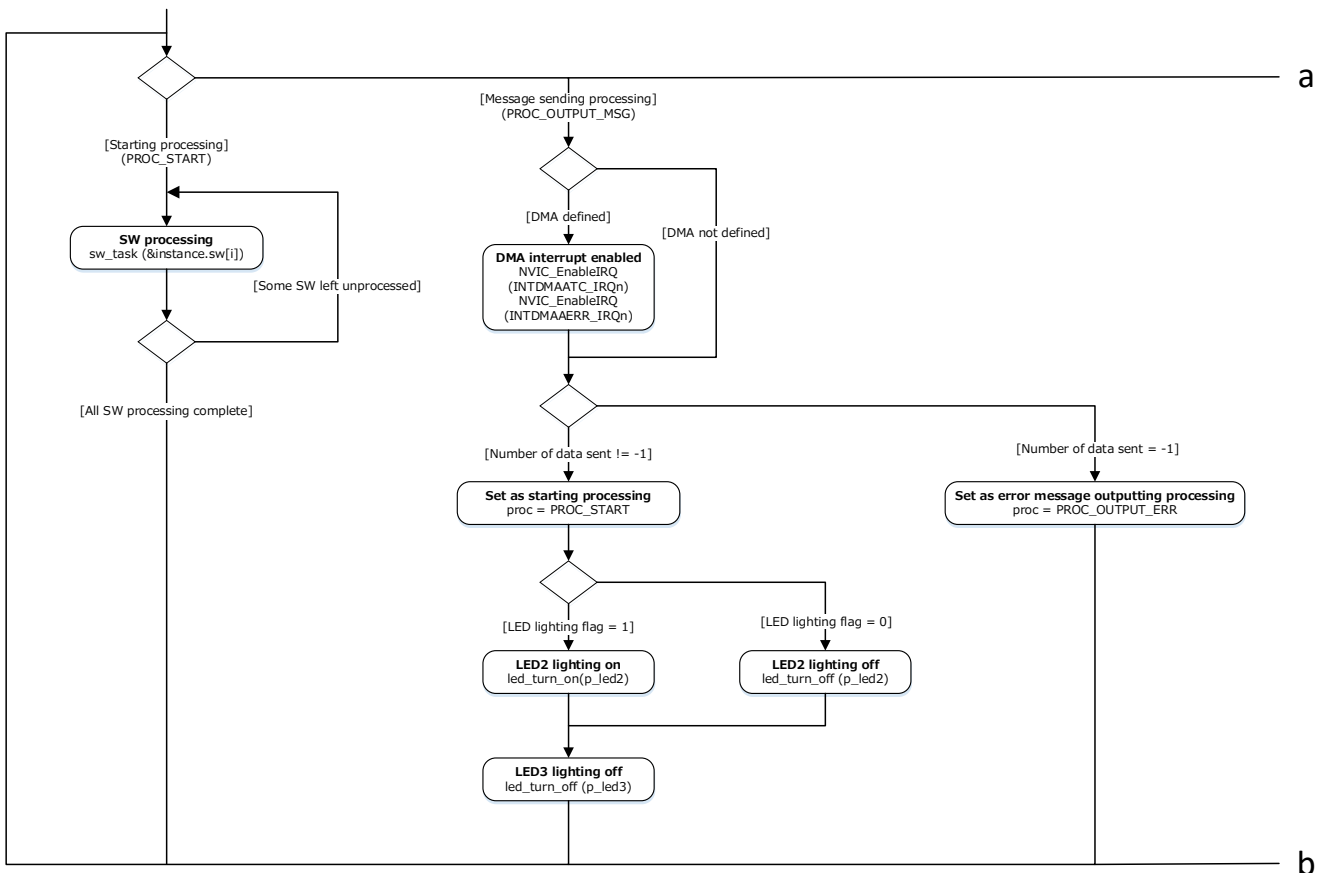

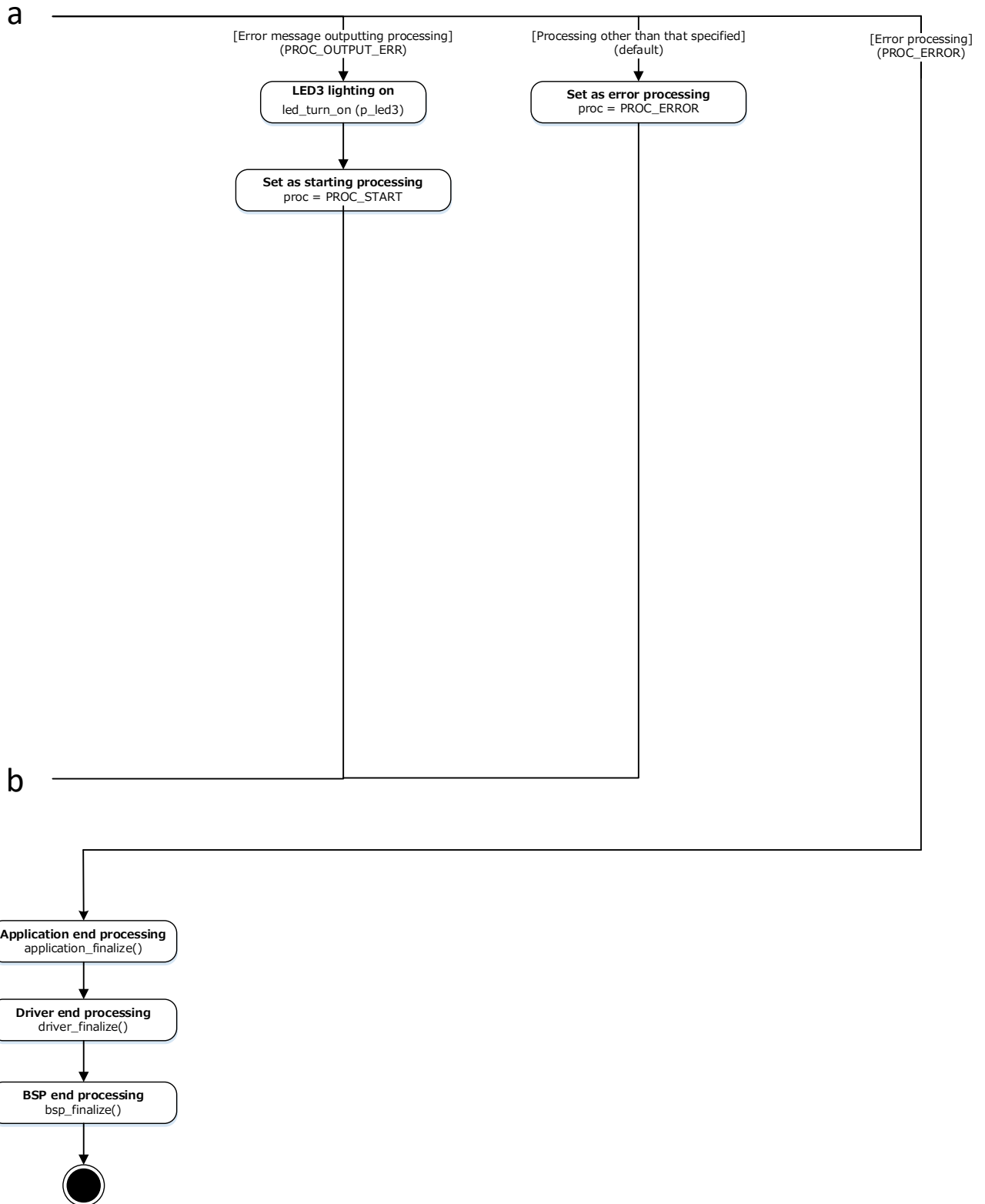

7.2. variable_initialize

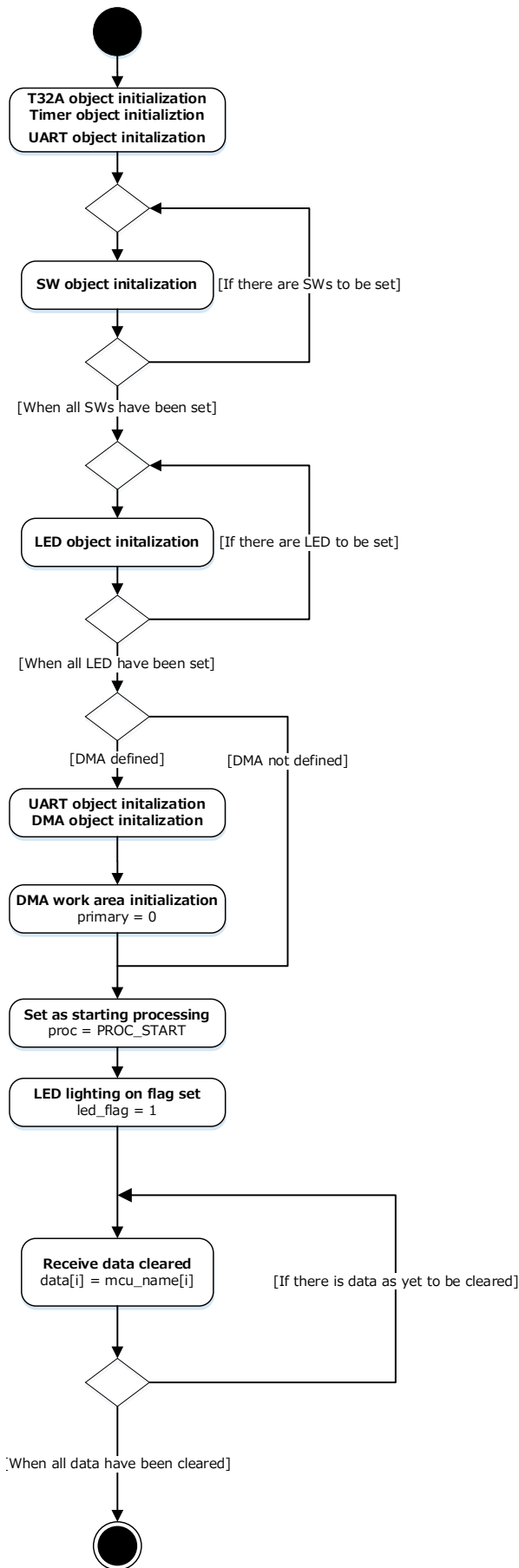

7.3. driver_initialize

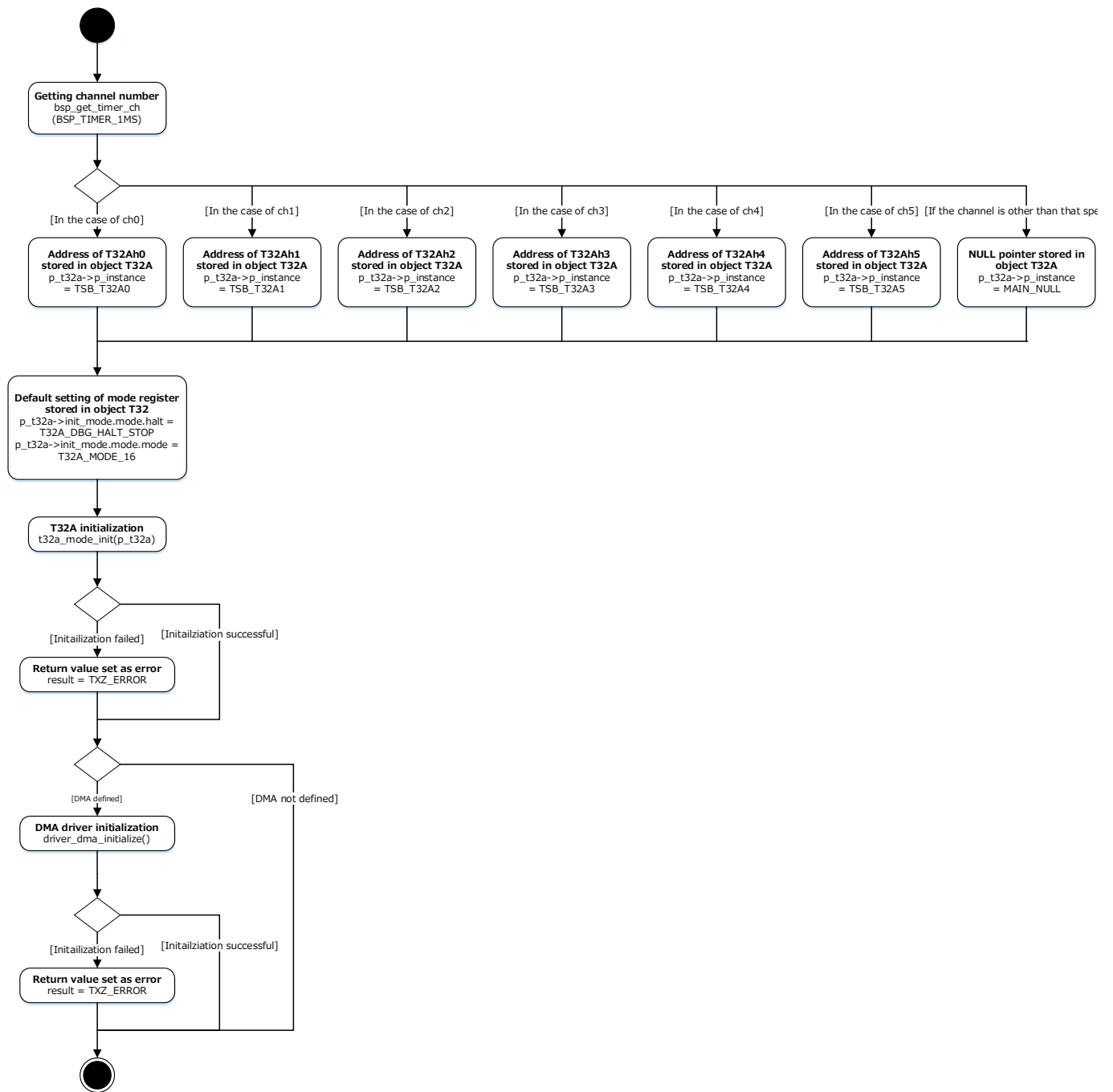

7.4. driver_finalize

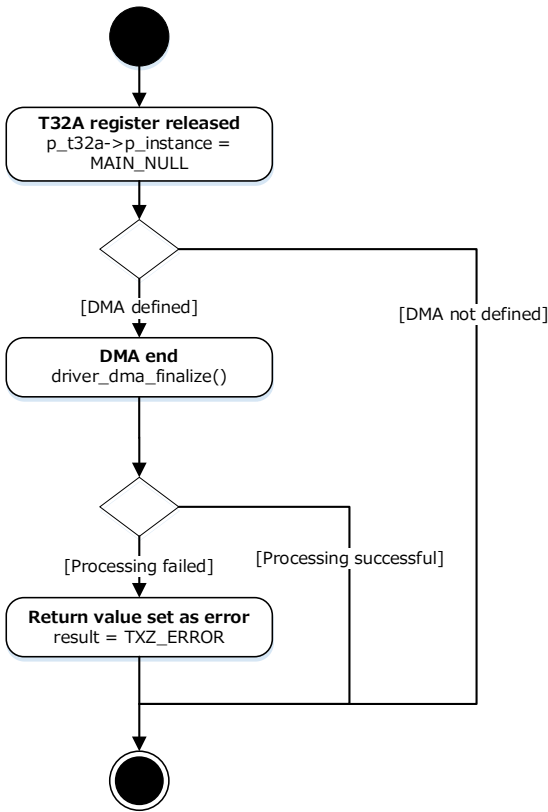

7.5. driver_dma_initialize

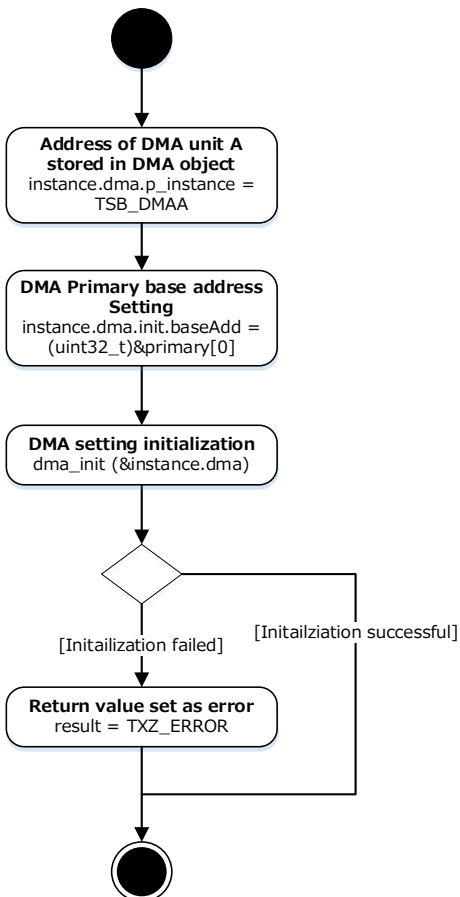

7.6. driver_dma_finalize

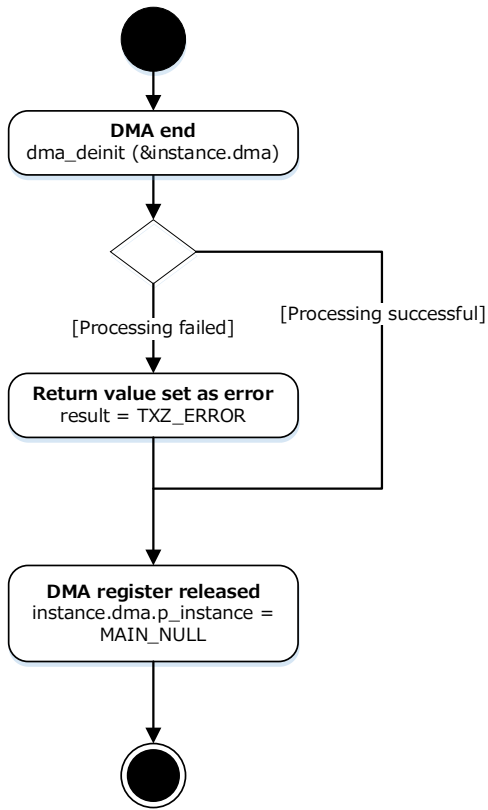

7.7. application_initialize

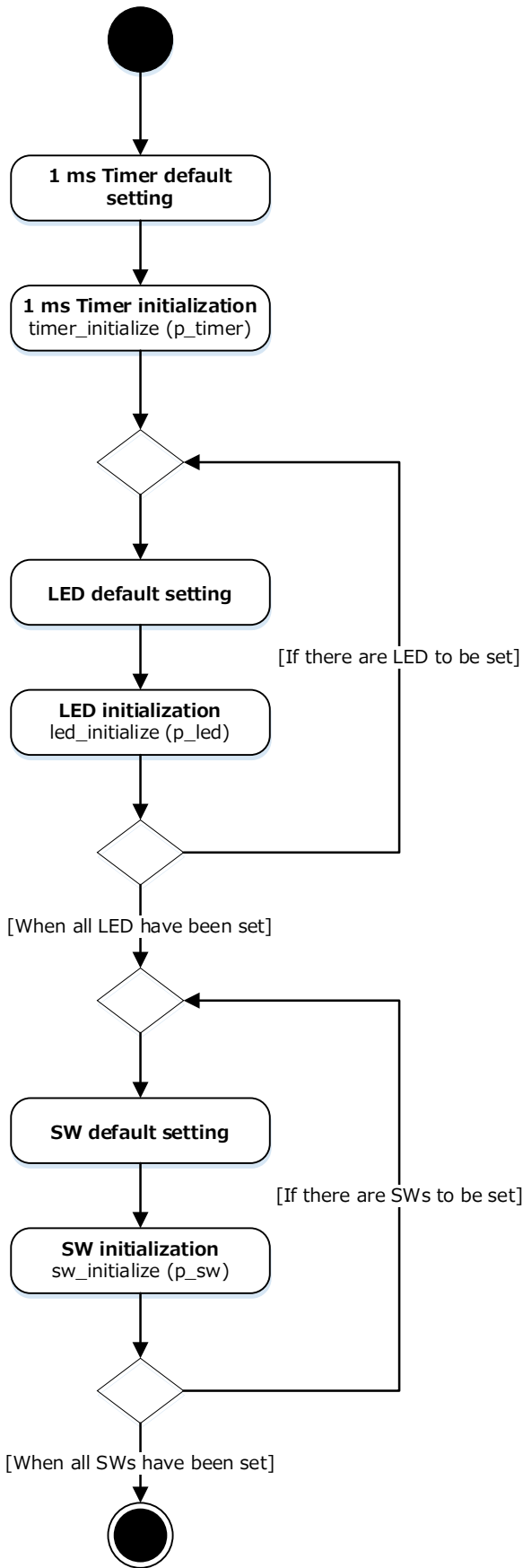

7.8. application_finalize

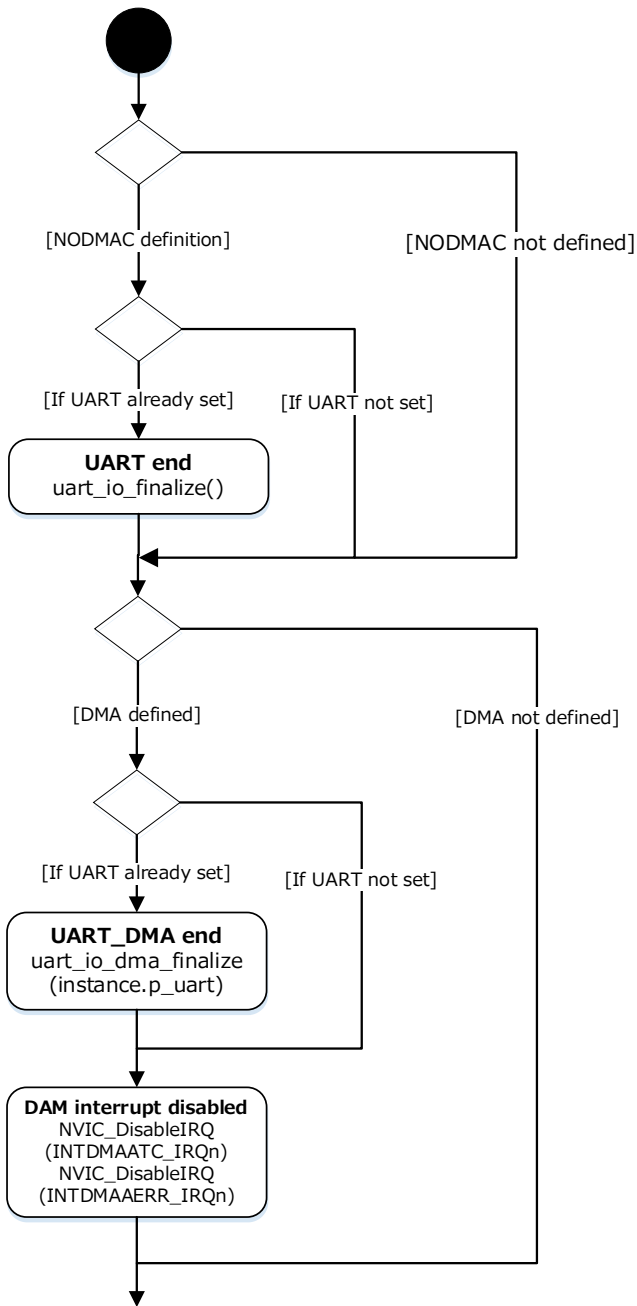

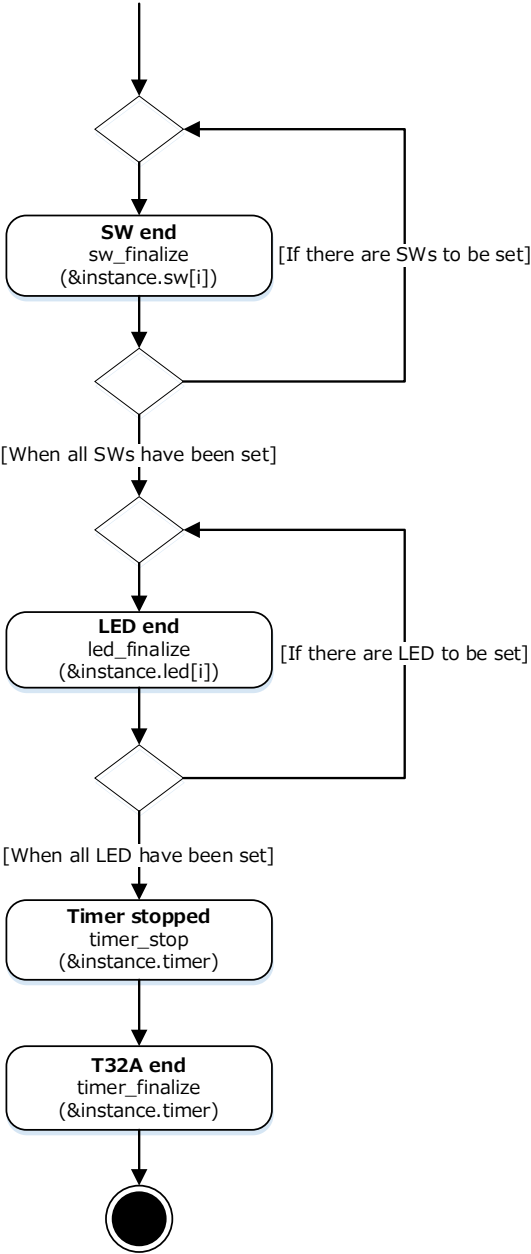

7.9. uart_initialize

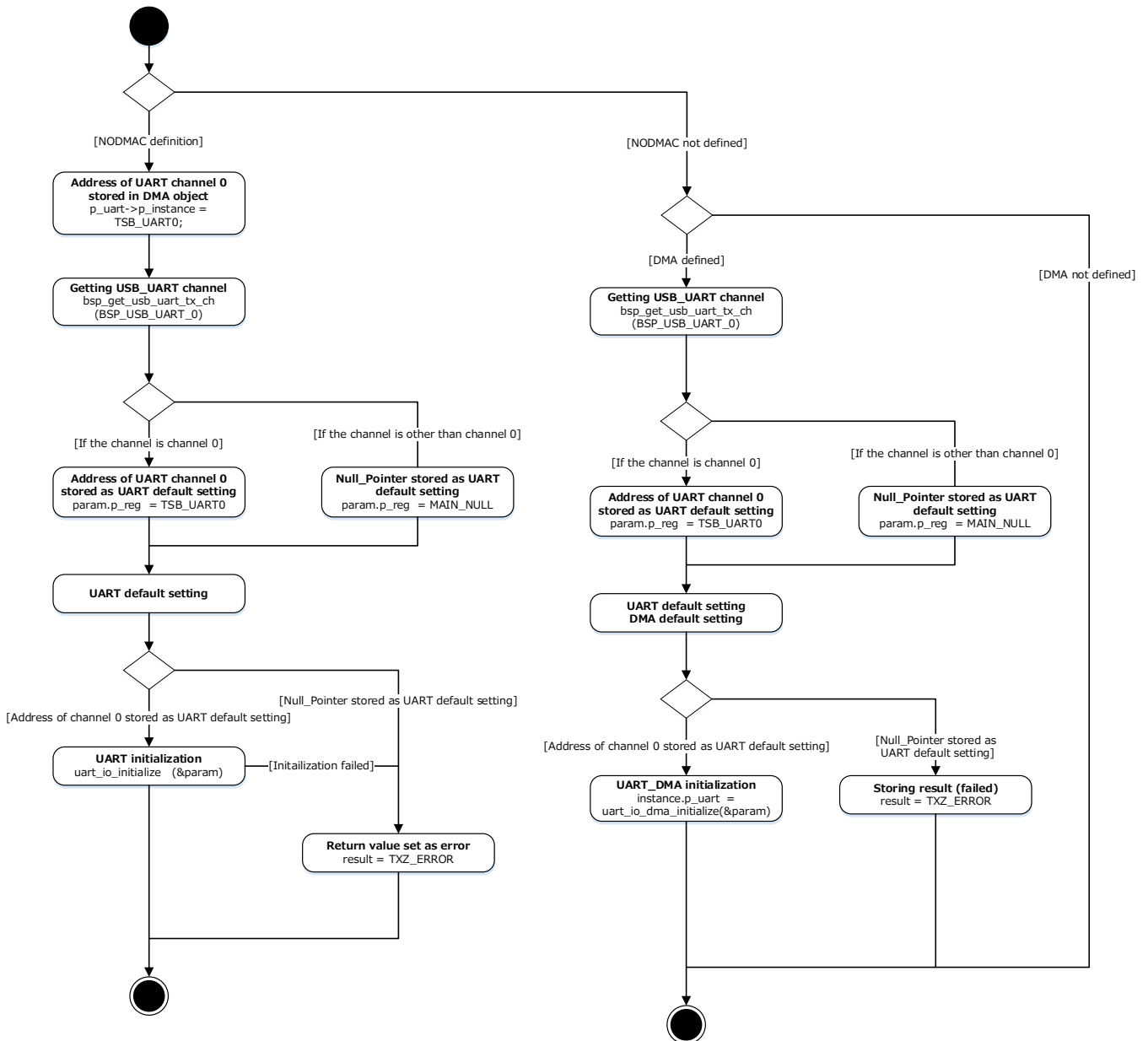

7.10. sw_state_change_handler

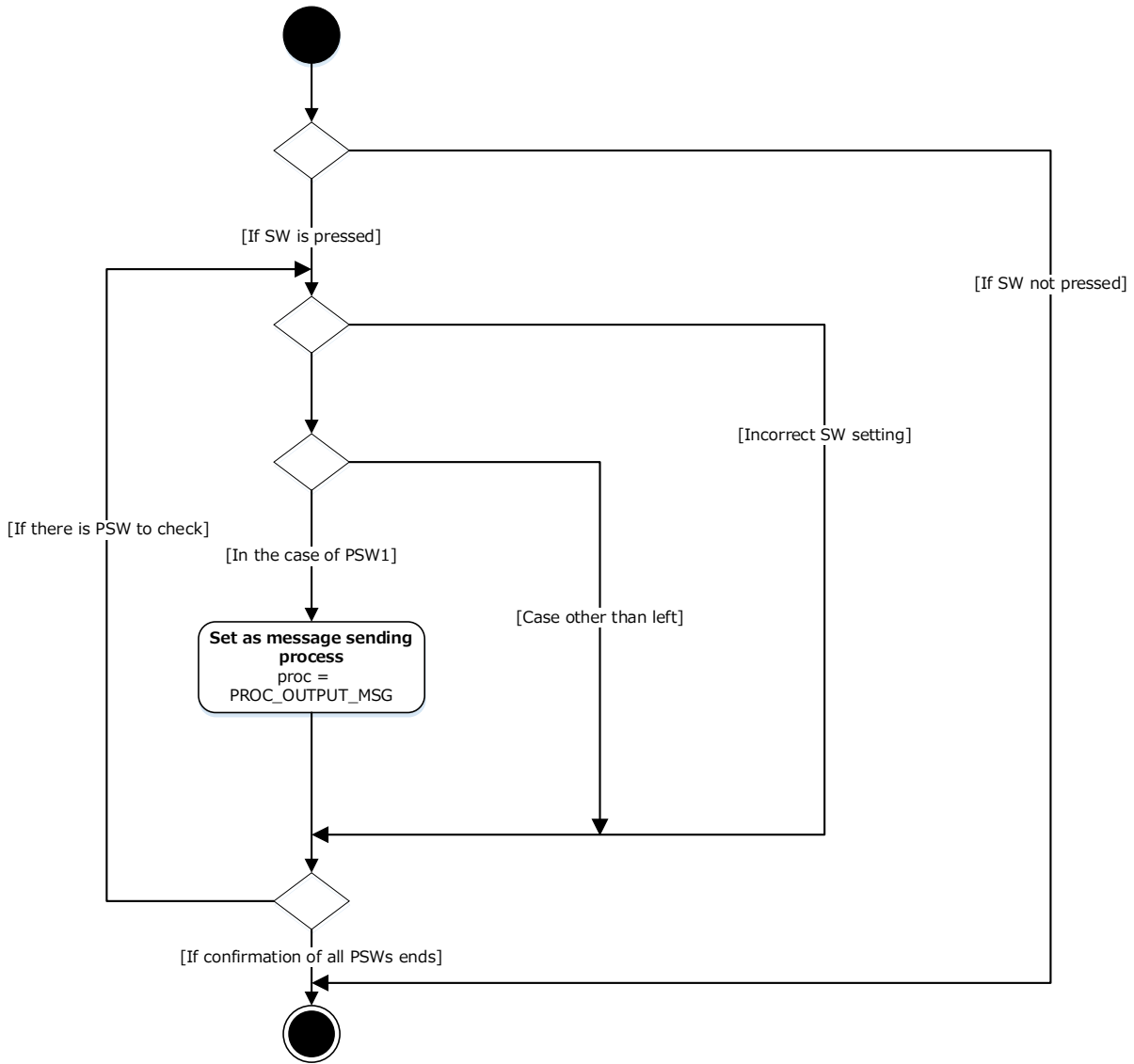

7.11. Interrupt

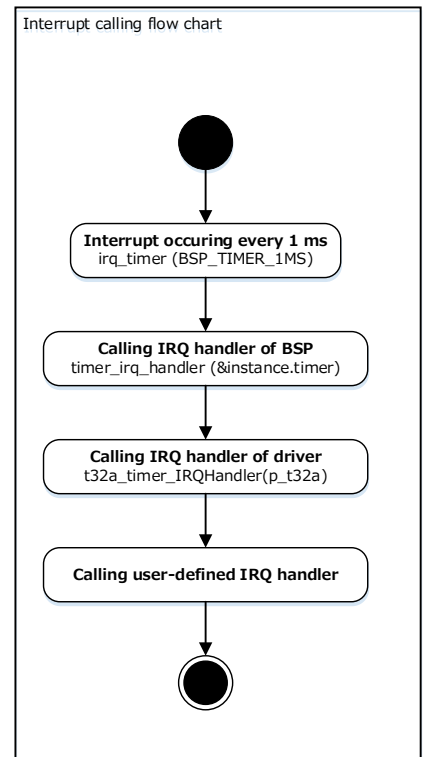
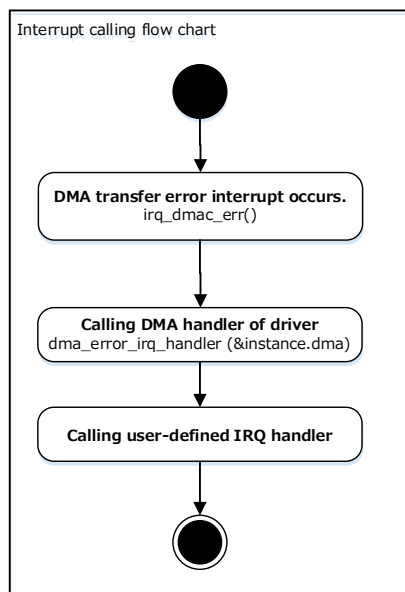
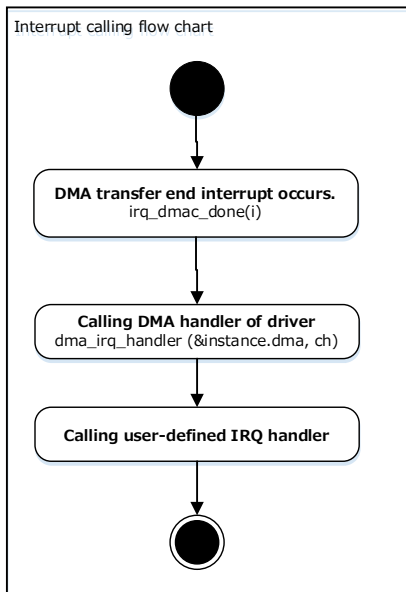
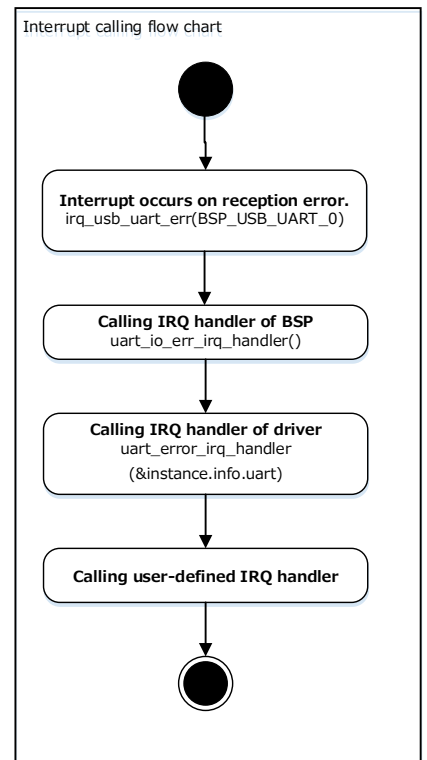
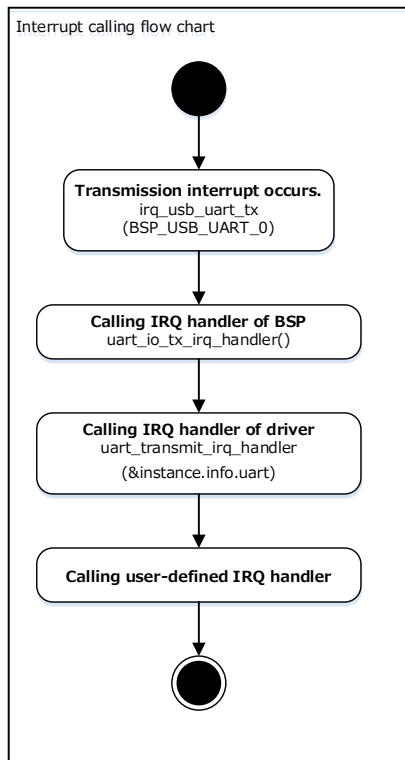
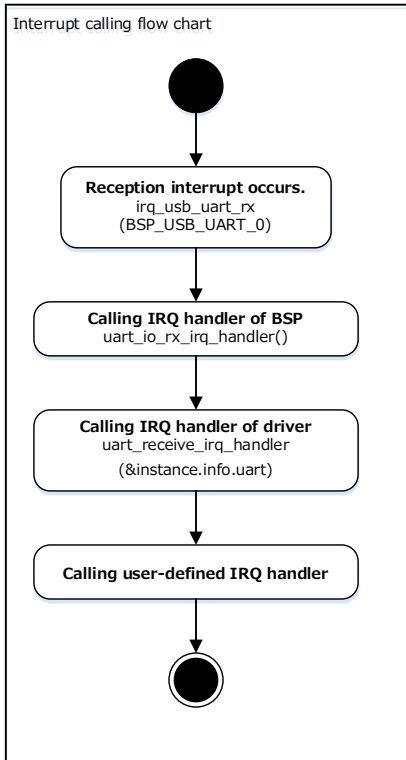

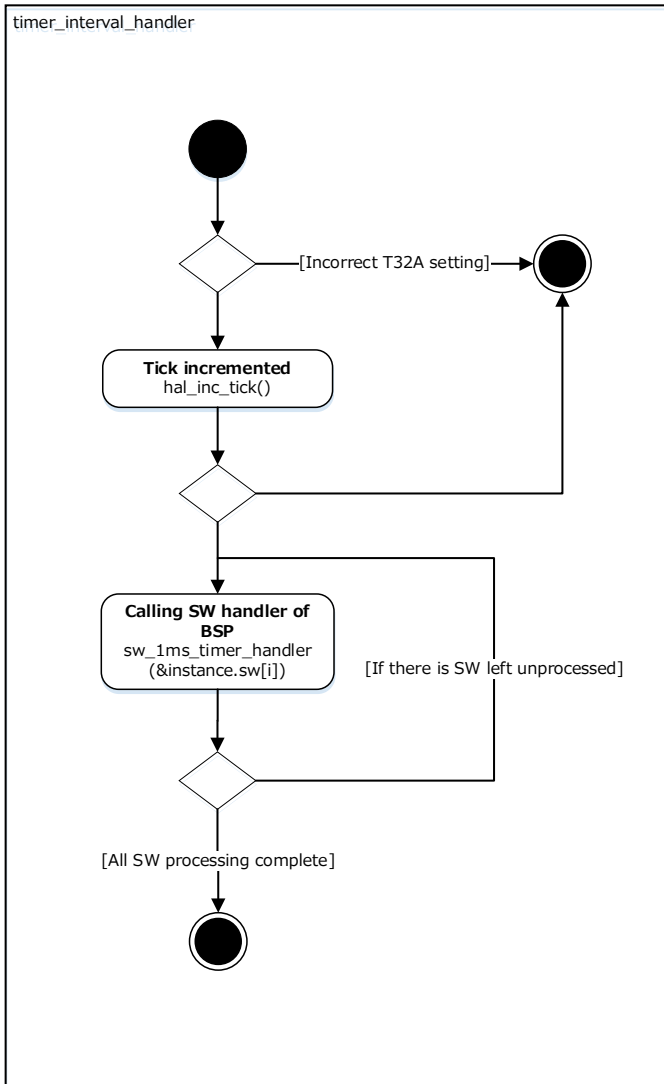

8. Revision History

Revision	Date	Description
1.0	2023-10-16	First release
1.1	2024-03-25	Added method to switch DMAC function

RESTRICTIONS ON PRODUCT USE

Toshiba Corporation and its subsidiaries and affiliates are collectively referred to as "TOSHIBA". Hardware, software and systems described in this document are collectively referred to as "Product".

- TOSHIBA reserves the right to make changes to the information in this document and related Product without notice.
- This document and any information herein may not be reproduced without prior written permission from TOSHIBA. Even with TOSHIBA's written permission, reproduction is permissible only if reproduction is without alteration/omission.
- Though TOSHIBA works continually to improve Product's quality and reliability, Product can malfunction or fail. Customers are responsible for complying with safety standards and for providing adequate designs and safeguards for their hardware, software and systems which minimize risk and avoid situations in which a malfunction or failure of Product could cause loss of human life, bodily injury or damage to property, including data loss or corruption. Before customers use the Product, create designs including the Product, or incorporate the Product into their own applications, customers must also refer to and comply with (a) the latest versions of all relevant TOSHIBA information, including without limitation, this document, the specifications, the data sheets and application notes for Product and the precautions and conditions set forth in the "TOSHIBA Semiconductor Reliability Handbook" and (b) the instructions for the application with which the Product will be used with or for. Customers are solely responsible for all aspects of their own product design or applications, including but not limited to (a) determining the appropriateness of the use of this Product in such design or applications; (b) evaluating and determining the applicability of any information contained in this document, or in charts, diagrams, programs, algorithms, sample application circuits, or any other referenced documents; and (c) validating all operating parameters for such designs and applications. **TOSHIBA ASSUMES NO LIABILITY FOR CUSTOMERS' PRODUCT DESIGN OR APPLICATIONS.**
- **PRODUCT IS NEITHER INTENDED NOR WARRANTED FOR USE IN EQUIPMENTS OR SYSTEMS THAT REQUIRE EXTRAORDINARILY HIGH LEVELS OF QUALITY AND/OR RELIABILITY, AND/OR A MALFUNCTION OR FAILURE OF WHICH MAY CAUSE LOSS OF HUMAN LIFE, BODILY INJURY, SERIOUS PROPERTY DAMAGE AND/OR SERIOUS PUBLIC IMPACT ("UNINTENDED USE").** Except for specific applications as expressly stated in this document, Unintended Use includes, without limitation, equipment used in nuclear facilities, equipment used in the aerospace industry, lifesaving and/or life supporting medical equipment, equipment used for automobiles, trains, ships and other transportation, traffic signaling equipment, equipment used to control combustions or explosions, safety devices, elevators and escalators, and devices related to power plant. **IF YOU USE PRODUCT FOR UNINTENDED USE, TOSHIBA ASSUMES NO LIABILITY FOR PRODUCT.** For details, please contact your TOSHIBA sales representative or contact us via our website.
- Do not disassemble, analyze, reverse-engineer, alter, modify, translate or copy Product, whether in whole or in part.
- Product shall not be used for or incorporated into any products or systems whose manufacture, use, or sale is prohibited under any applicable laws or regulations.
- The information contained herein is presented only as guidance for Product use. No responsibility is assumed by TOSHIBA for any infringement of patents or any other intellectual property rights of third parties that may result from the use of Product. No license to any intellectual property right is granted by this document, whether express or implied, by estoppel or otherwise.
- **ABSENT A WRITTEN SIGNED AGREEMENT, EXCEPT AS PROVIDED IN THE RELEVANT TERMS AND CONDITIONS OF SALE FOR PRODUCT, AND TO THE MAXIMUM EXTENT ALLOWABLE BY LAW, TOSHIBA (1) ASSUMES NO LIABILITY WHATSOEVER, INCLUDING WITHOUT LIMITATION, INDIRECT, CONSEQUENTIAL, SPECIAL, OR INCIDENTAL DAMAGES OR LOSS, INCLUDING WITHOUT LIMITATION, LOSS OF PROFITS, LOSS OF OPPORTUNITIES, BUSINESS INTERRUPTION AND LOSS OF DATA, AND (2) DISCLAIMS ANY AND ALL EXPRESS OR IMPLIED WARRANTIES AND CONDITIONS RELATED TO SALE, USE OF PRODUCT, OR INFORMATION, INCLUDING WARRANTIES OR CONDITIONS OF MERCHANTABILITY, FITNESS FOR A PARTICULAR PURPOSE, ACCURACY OF INFORMATION, OR NONINFRINGEMENT.**
- Do not use or otherwise make available Product or related software or technology for any military purposes, including without limitation, for the design, development, use, stockpiling or manufacturing of nuclear, chemical, or biological weapons or missile technology products (mass destruction weapons). Product and related software and technology may be controlled under the applicable export laws and regulations including, without limitation, the Japanese Foreign Exchange and Foreign Trade Law and the U.S. Export Administration Regulations. Export and re-export of Product or related software or technology are strictly prohibited except in compliance with all applicable export laws and regulations.
- Please contact your TOSHIBA sales representative for details as to environmental matters such as the RoHS compatibility of Product. Please use Product in compliance with all applicable laws and regulations that regulate the inclusion or use of controlled substances, including without limitation, the EU RoHS Directive. **TOSHIBA ASSUMES NO LIABILITY FOR DAMAGES OR LOSSES OCCURRING AS A RESULT OF NONCOMPLIANCE WITH APPLICABLE LAWS AND REGULATIONS.**

Toshiba Electronic Devices & Storage Corporation

<https://toshiba.semicon-storage.com/>