

Application Note

CG_EXINT

(CG-M4K(2)-E)

Arm and Keil are registered trademarks of Arm Limited (or its subsidiaries) in the US and/or elsewhere.

All other company names, product names, and service names mentioned herein may be trademarks of their respective companies.

Table of Contents

Table of Contents.....	2
1. Preface	4
2. Technical Term	4
3. Reference Document	4
4. Target Sample Program.....	5
5. Configuration Diagram	5
6. Sample Program:CG_EXINT	6
6.1. Outlines of Operation.....	6
6.2. Function to Use.....	6
6.3. Interrupt to Use	6
6.4. Configuration.....	7
6.5. Example of Terminal Emulator Output	7
7. Activity diagram.....	8
7.1. main	8
7.2. vaiable_initialize.....	10
7.3. driver_initialize_normal	10
7.4. driver_finalize_normal.....	11
7.5. application_initialize_normal.....	11
7.6. application_finalize_normal	12
7.7. noraml_start.....	12
7.8. normal_end.....	13
7.9. driver_initialize_idle.....	13
7.10. driver_finalize_idle	13
7.11. application_initialize_idle	14
7.12. application_finalize_idle.....	14
7.13. low_power_start_idle	15
7.14. low_power_end_idle	16
7.15. driver_initialize_stop1	16
7.16. driver_finalize_stop1.....	16
7.17. application_initialize_stop1.....	17
7.18. application_finalize_stop1.....	17
7.19. low_power_start_stop1	18
7.20. low_power_end_stop1	20
7.21. driver_initialize_stop2	20
7.22. application_initialize_stop2.....	21
7.23. low_power_start_stop2.....	21
7.24. Interrupt.....	23
8. Revision History	25

RESTRICTIONS ON PRODUCT USE26

1. Preface

This application note describes sample software for the switches between NORMAL mode and low power consumption mode using clock control and operation mode functions.

This document helps the user check operation of a product under development and develop its program.

2. Technical Term

Term/Abbreviation	Definition
BSP	Board Support Package
CG	Clock Control and Operation Mode
EXCEPT	Except
FLASH	Flash Memory
SIWDT	Clock Selective Watchdog Timer
Timer	T32A:32-bit Timer Event Counter

3. Reference Document

Document	Notes
Data sheet	Refer to the data sheet of MCU to be used.
Reference manual	Refer to the reference manual of each IP to be used.
Application note MCU User Guide	Refer to the MCU user guide to be used.

4. Target Sample Program

Sample Program	Outline
CG_EXINT	Sample program of clock control and operation mode switching

5. Configuration Diagram

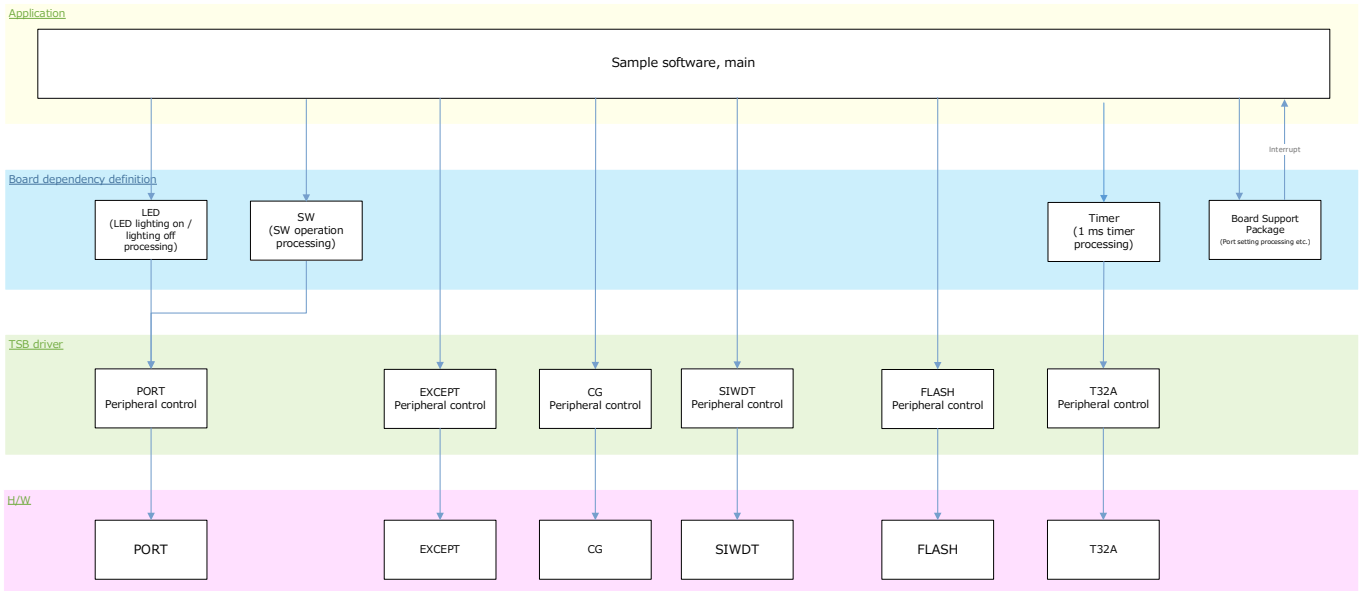

6. Sample Program:CG_EXINT

This is the sample software that uses CG operation mode transition function to shift to the low-power consumption mode and return to NORMAL mode according to the pressed switches.
Visualizes the operation mode by LED.

6.1. Outlines of Operation

Switches (NORMAL/IDLE/STOP1/STOP2) when pressed.

When BSP_PSW_1 is pressed, IDLE mode is entered.
However, it is invalid when pressed during low power consumption mode.

When BSP_PSW_2 is pressed, STOP1 mode is entered.
However, it is invalid when pressed during low power consumption mode.

When BSP_PSW_3 is pressed, STOP2 mode is entered.
However, it is invalid when pressed during low power consumption mode.

When BSP_PSW_5 is pressed, NORMAL mode is entered.
However, if it is pressed during NORMAL, it is disabled.

LED is turned on and off according to the selected mode.

NORMAL mode : BSP_LED_1 blink at a constant Duty for a fixed period. All other LED are turned off.

IDLE mode : BSP_LED_2 is turned on. All other LED are turned off.

STOP1 mode : BSP_LED_3 is turned on. All other LED are turned off.

STOP2 mode : BSP_LED_4 is turned on. All other LED are turned off.

6.2. Function to Use

The functions to use are as follows:

For the Port assignment of each BSP channel, refer to the MCU user guide.

IP	Channel	Objective
PORT (Push Switch)	BSP_PSW_1	Event trigger
	BSP_PSW_2	Event trigger
	*BSP_PSW_3	*Event trigger
	*BSP_PSW_5	*Event trigger
PORT(LED)	BSP_LED_1	For operation check
	BSP_LED_2	For operation check
	BSP_LED_3	For operation check
	BSP_LED_4	For operation check
T32A	BSP_T32A_TIMER_1	Interval timer

* SBK-M4KN does not support STOP2 and does not have BSP_PSW_3.

* SBK-M4KN substitutes BSP_SSW_1.

6.3. Interrupt to Use

Interrupt	Outlines
INT21	External interrupt when pressing BSP_PSW_5. For canceling low power consumption mode
INTT32A00A	T32A Timer A Timer counter increments every 1ms for Switch / LED processing

6.4. Configuration

“main.c” configuration setting.

Configuration	Current Value	Description
CFG_LED_BLINK_FRQ	2	LED blink Cycle (Unit:Hz)
CFG_LED_BLINK_DUTY	0.5	LED blink Duty (50%)

6.5. Example of Terminal Emulator Output

Nothing.

7. Activity diagram

7.1. main

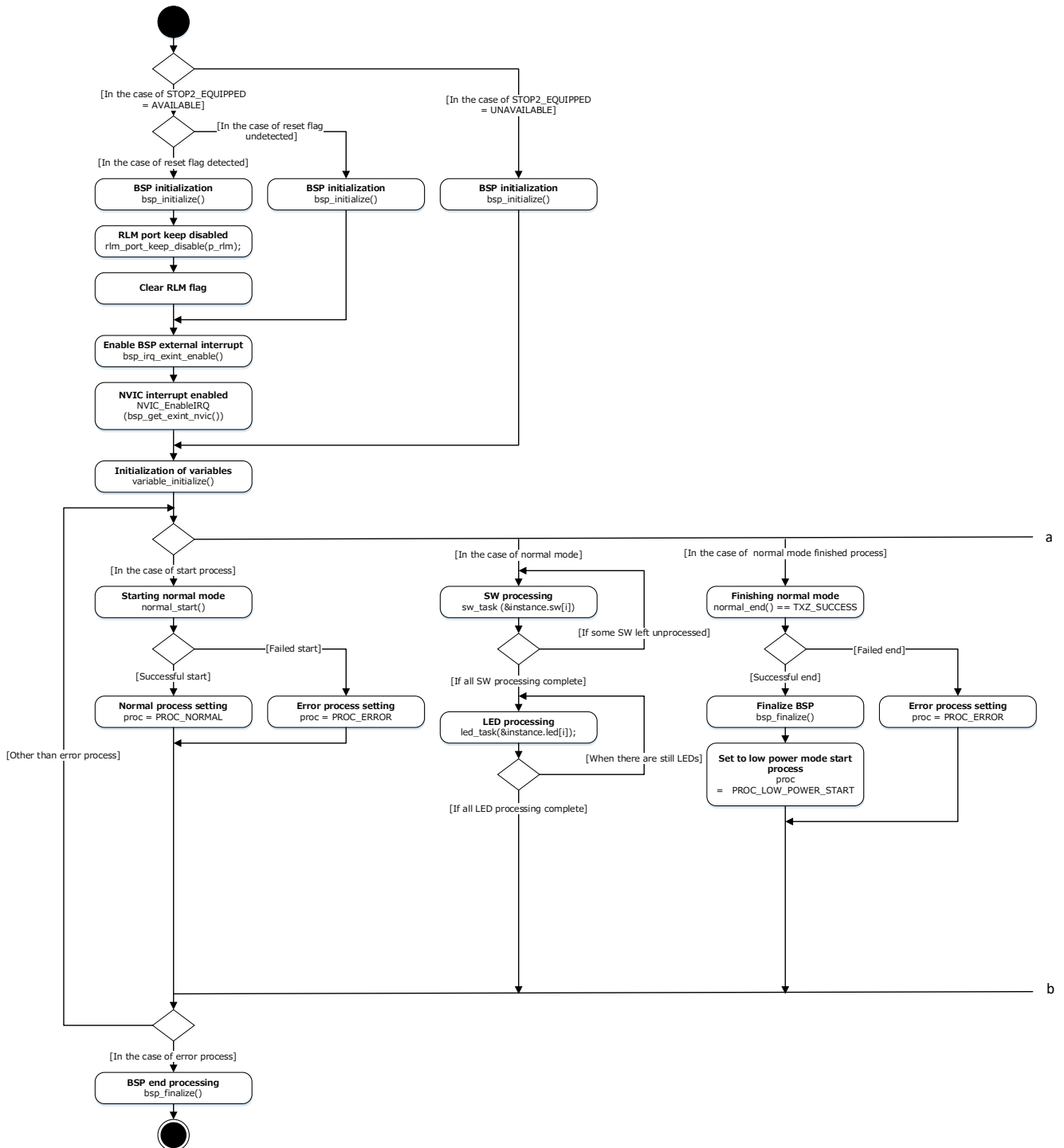

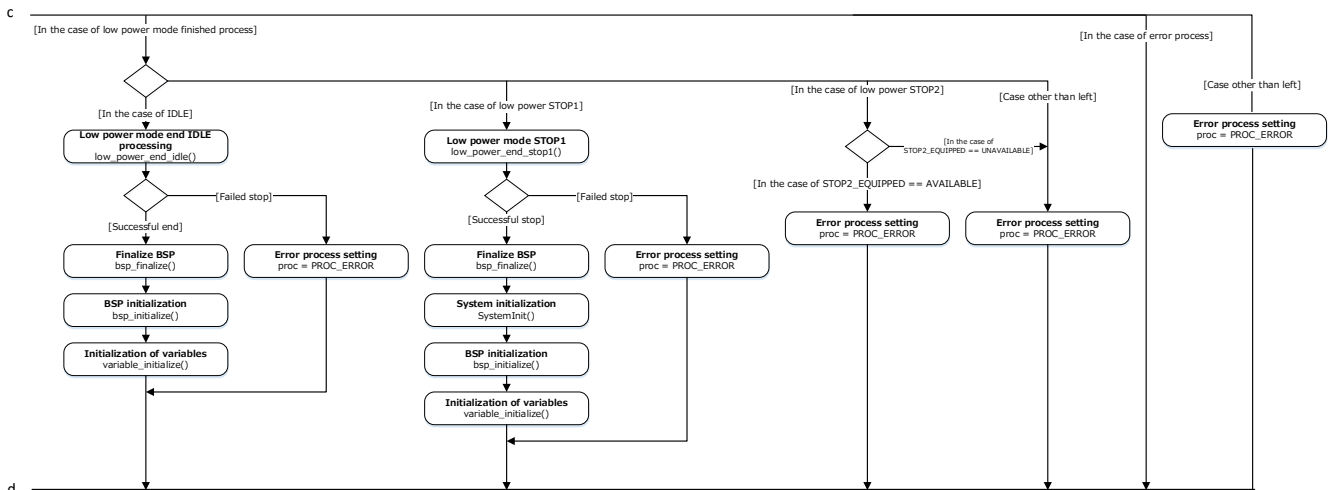
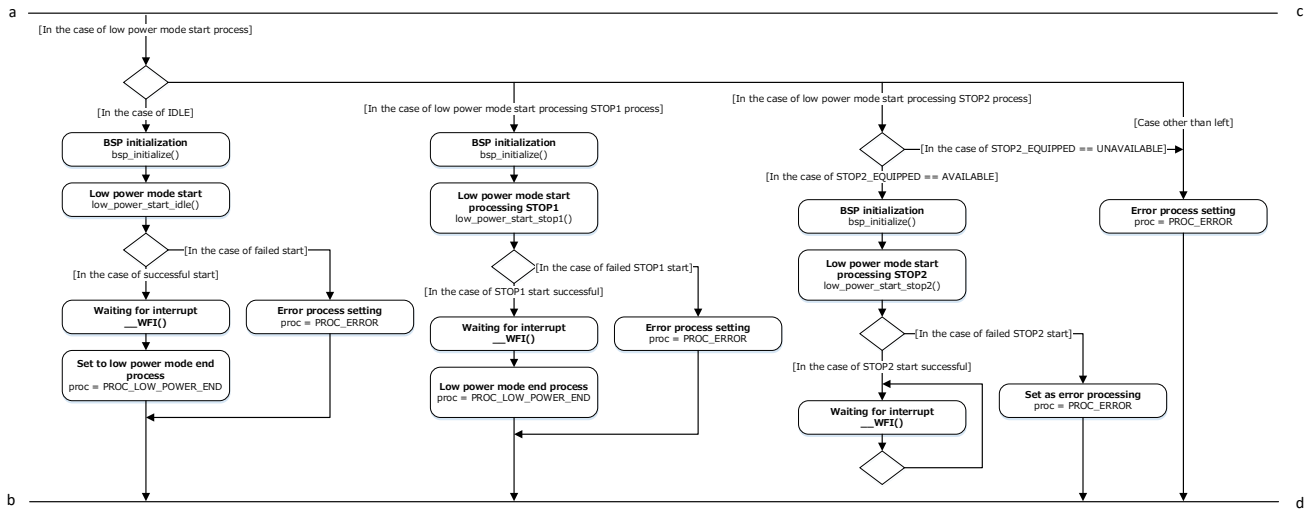

7.2. vaiable_initialize

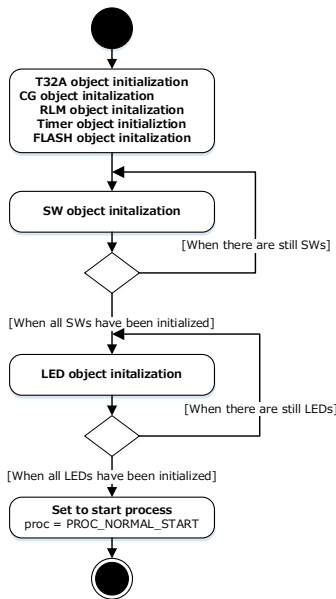

7.3. driver_initialize_normal

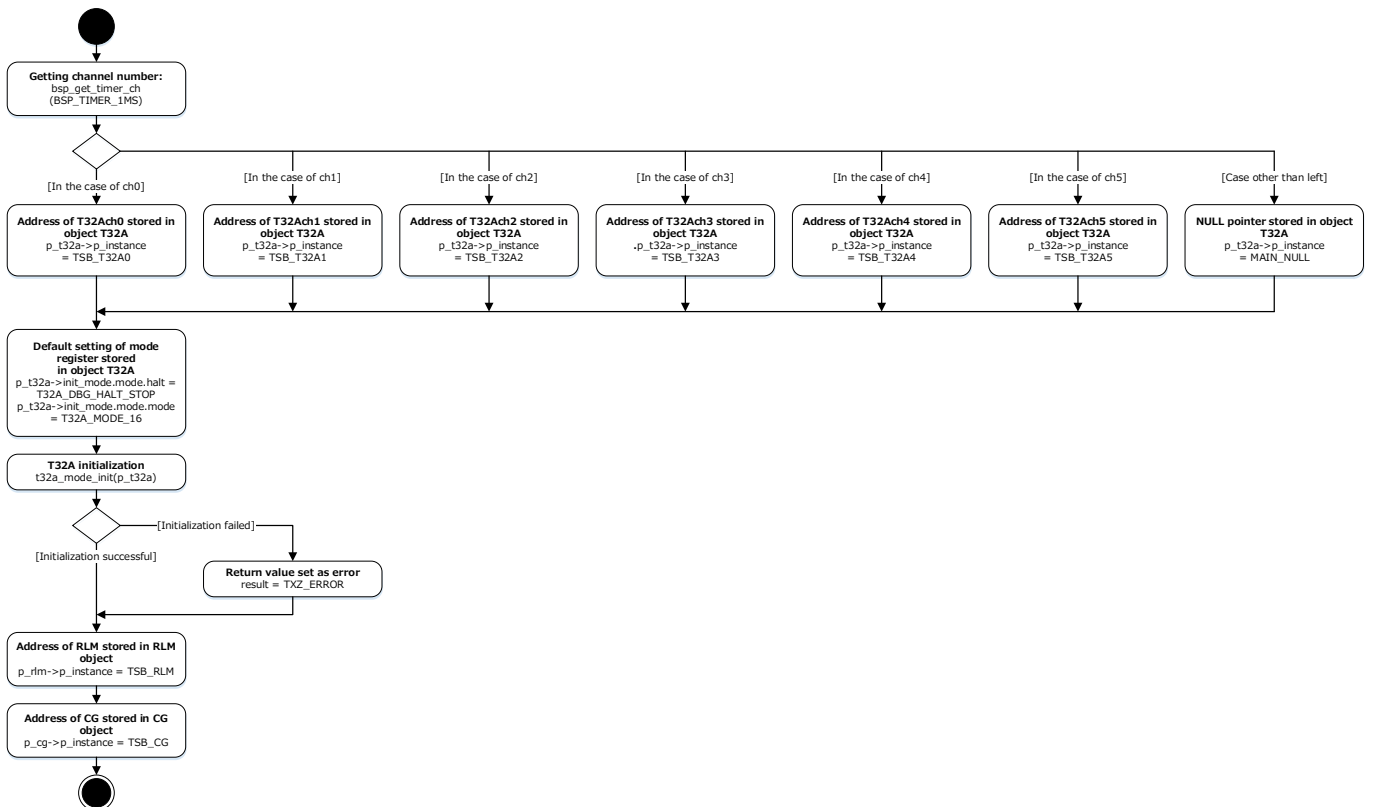

7.4. driver_finalize_normal

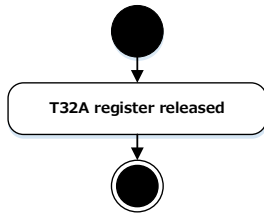

7.5. application_initialize_normal

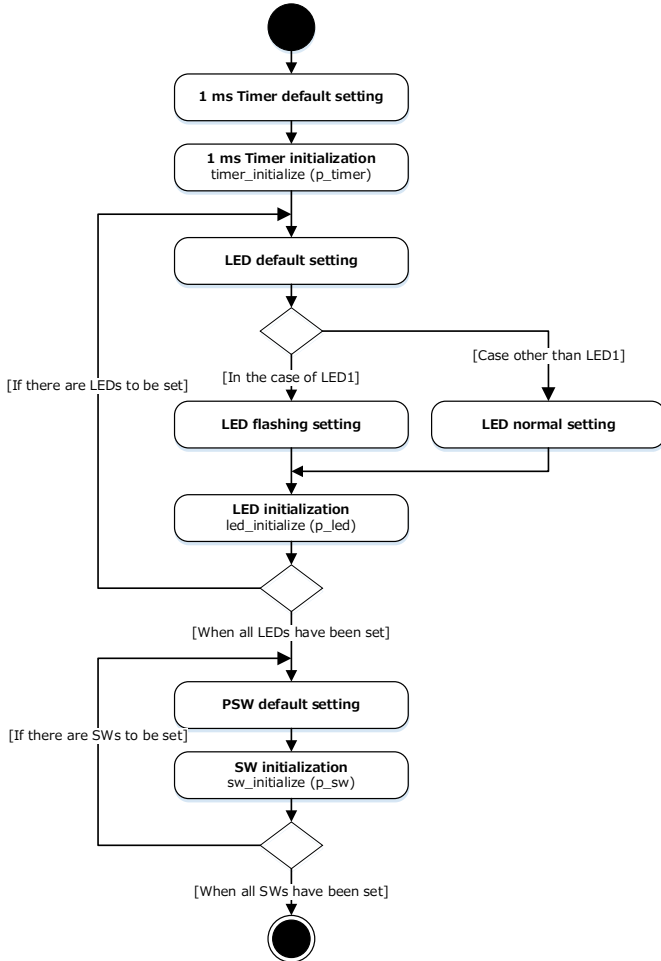

7.6. application_finalize_normal

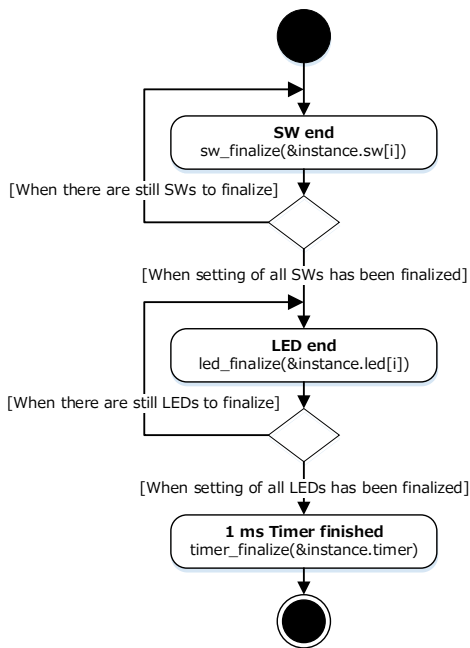

7.7. noraml_start

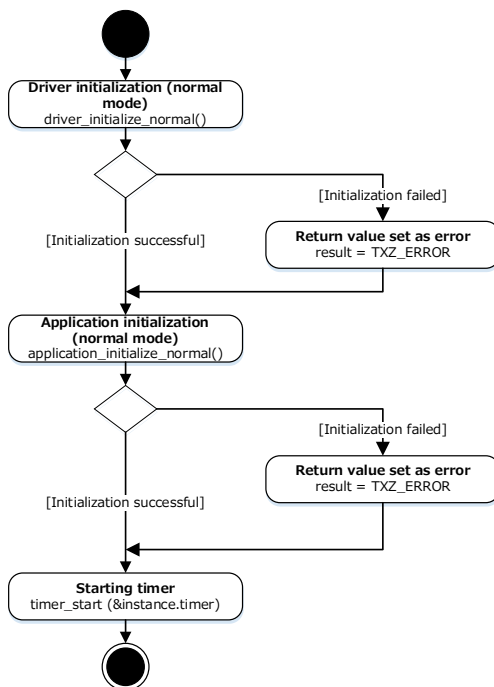

7.8. normal_end

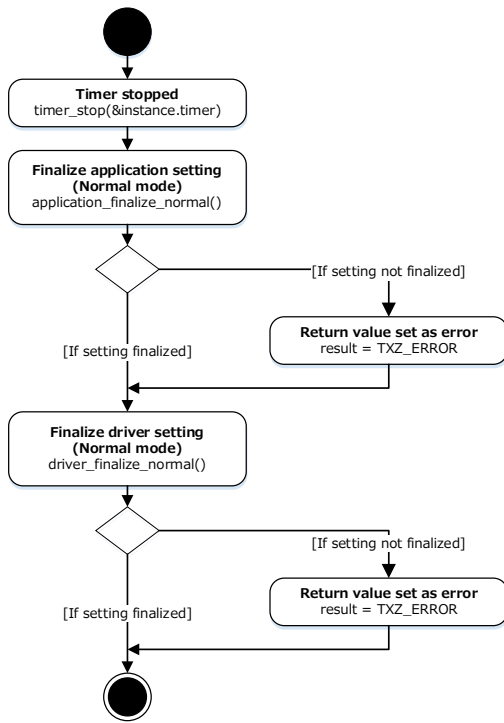

7.9. driver_initialize_idle

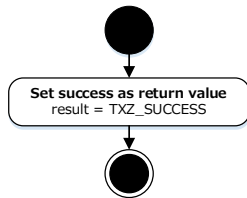

7.10. driver_finalize_idle

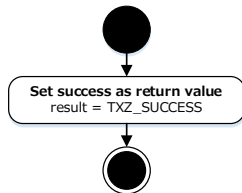

7.11. application_initialize_idle

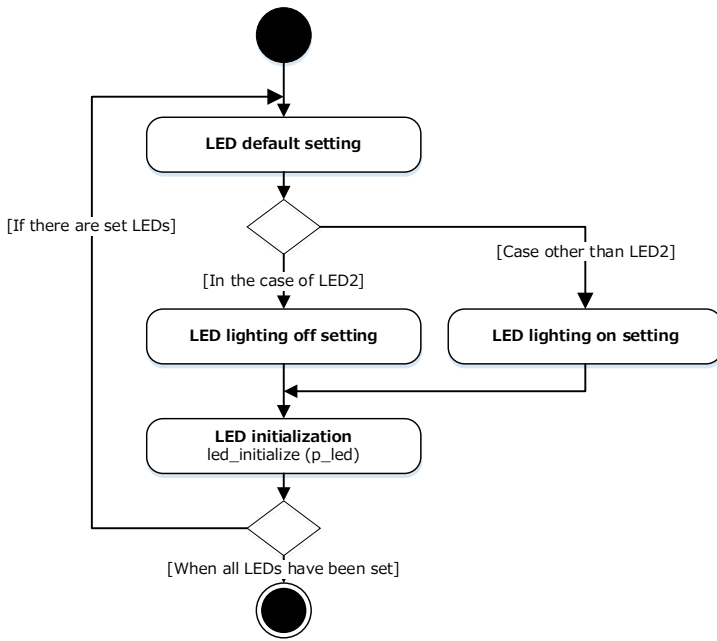

7.12. application_finalize_idle

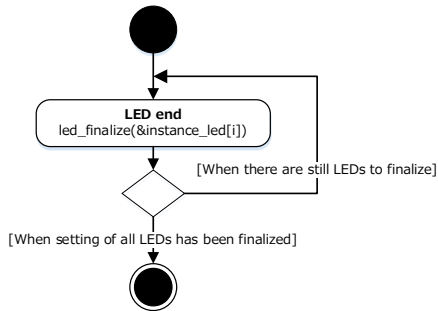

7.13. low_power_start_idle

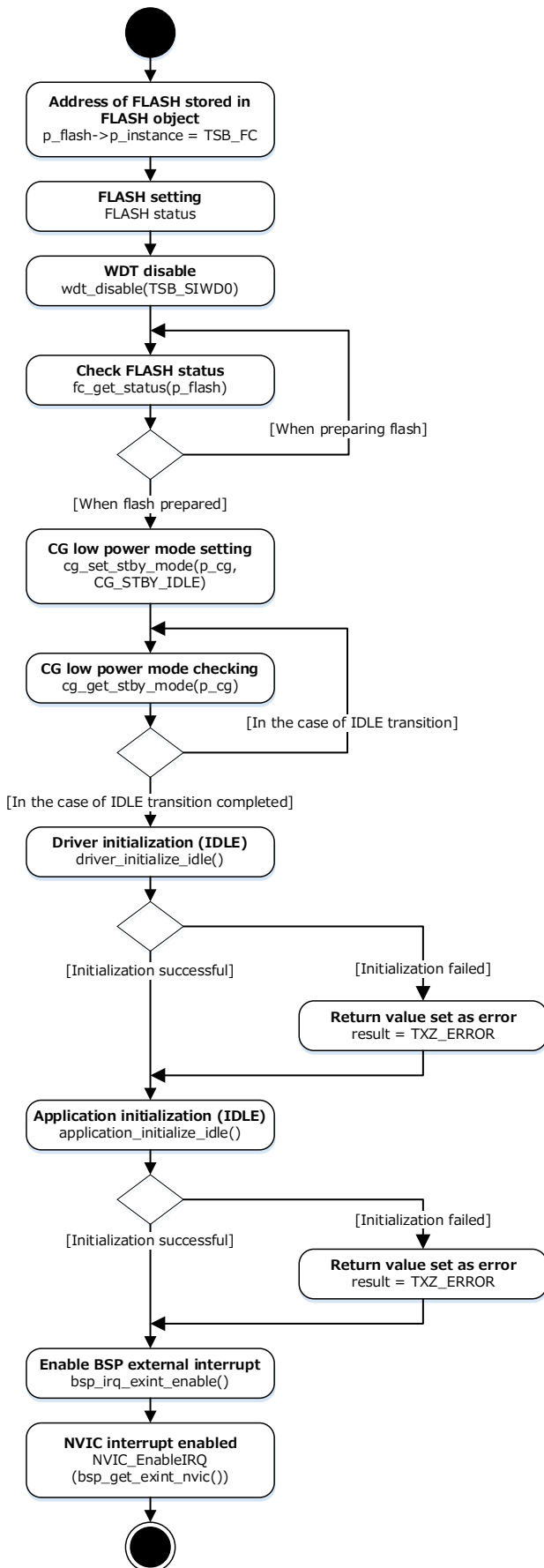

7.14. low_power_end_idle

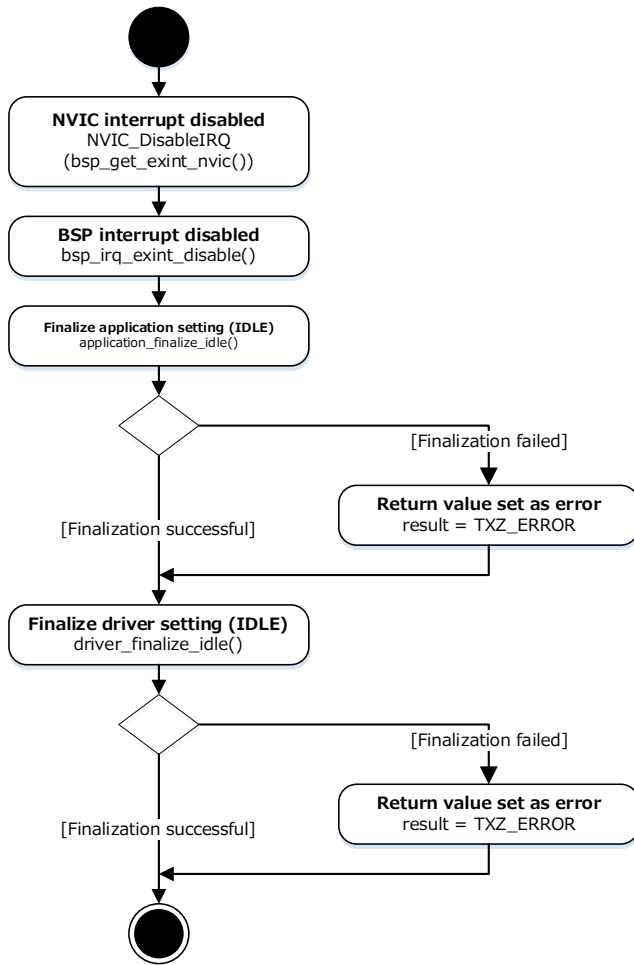

7.15. driver_initialize_stop1

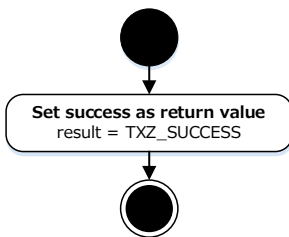

7.16. driver_finalize_stop1

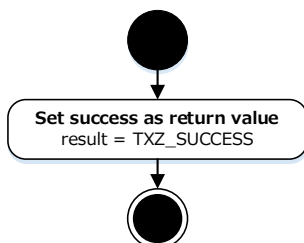

7.17. application_initialize_stop1

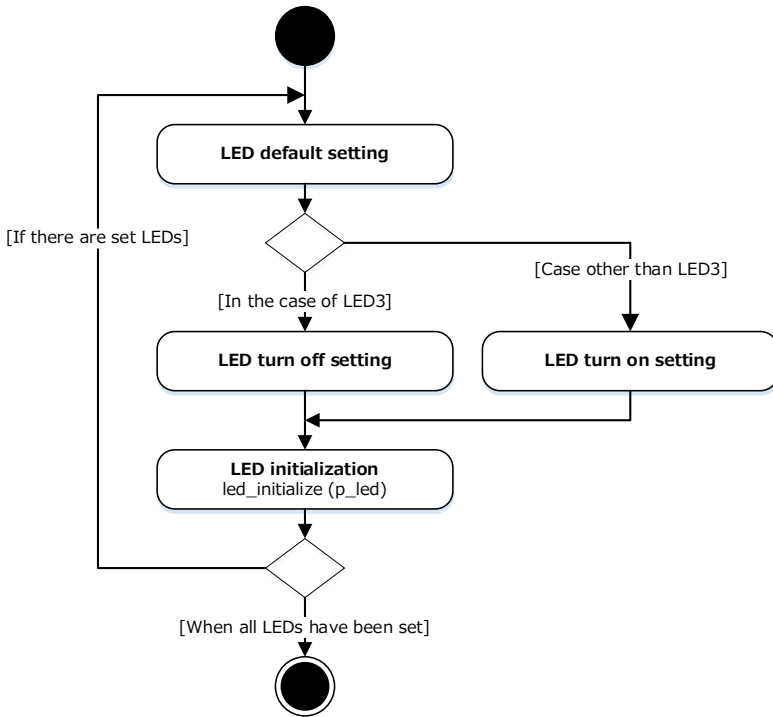

7.18. application_finalize_stop1

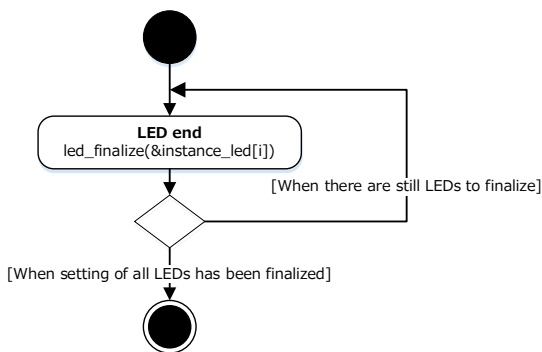

7.19. low_power_start_stop1

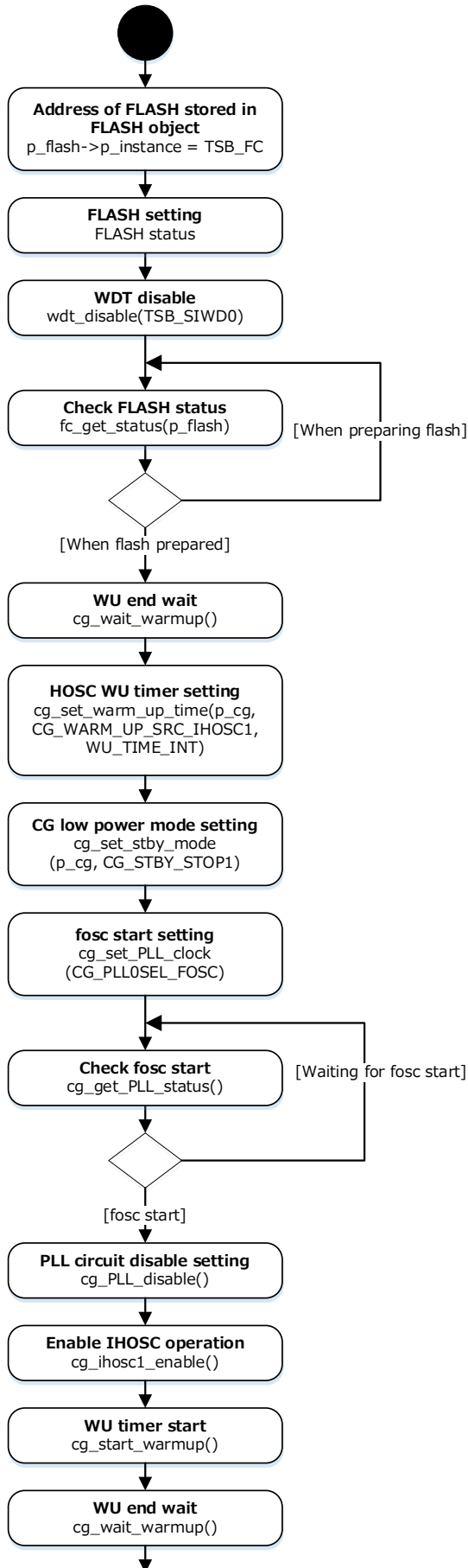

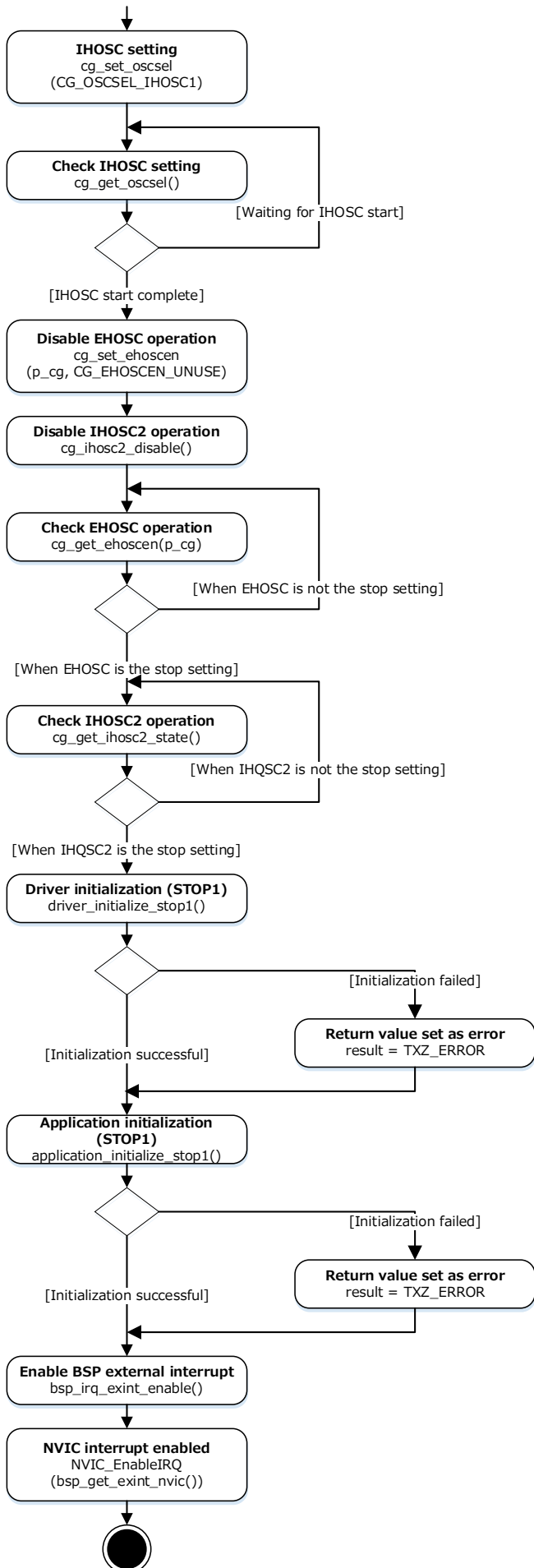

7.20. low_power_end_stop1

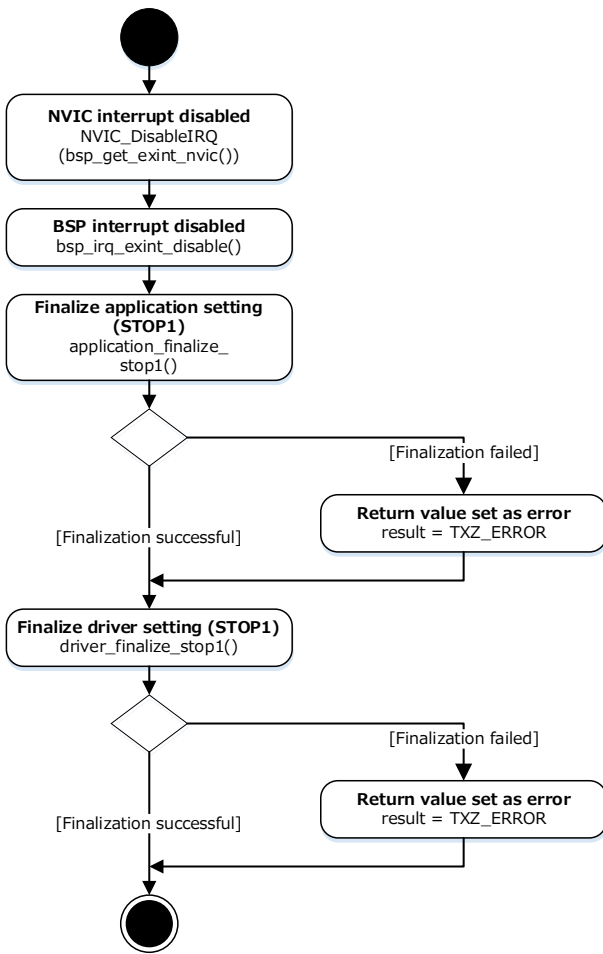

7.21. driver_initialize_stop2

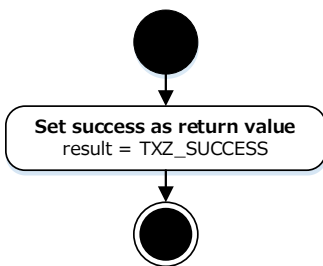

When STOP2_EQUIPPED is defined

7.22. application_initialize_stop2

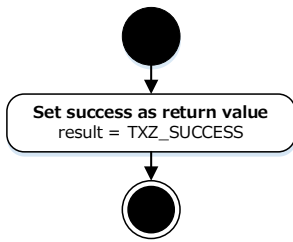

When STOP2_EQUIPPED is defined

7.23. low_power_start_stop2

When STOP2_EQUIPPED is defined

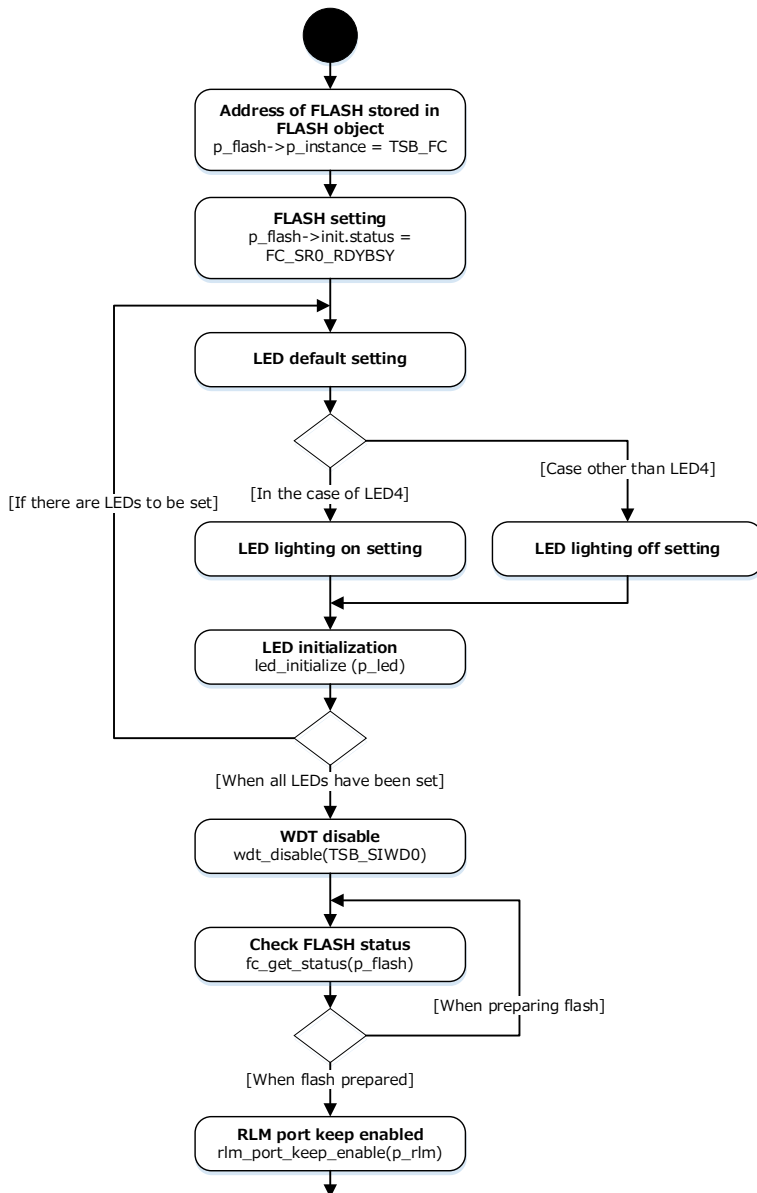

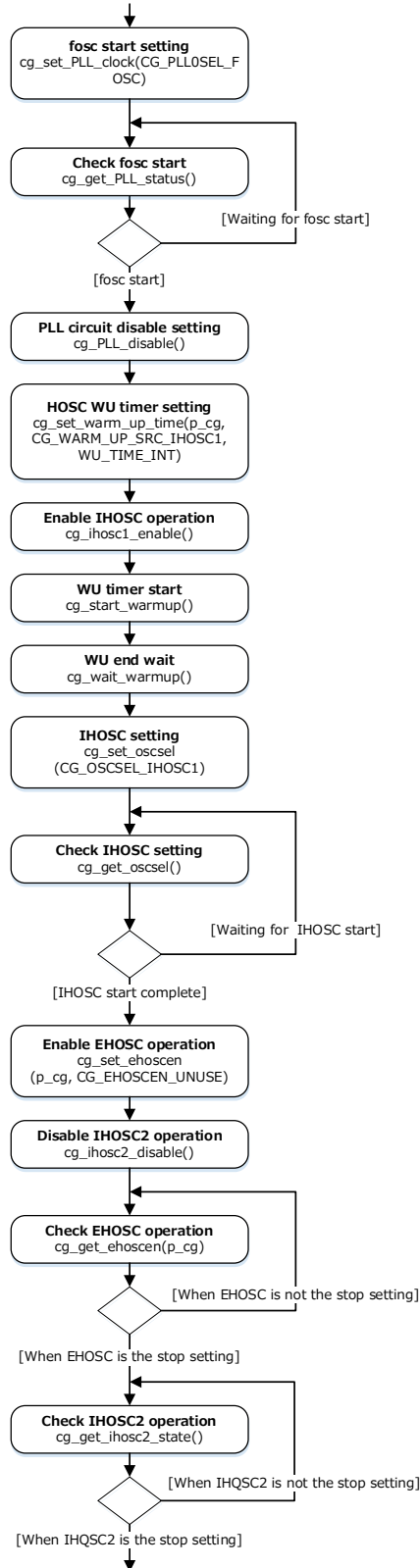

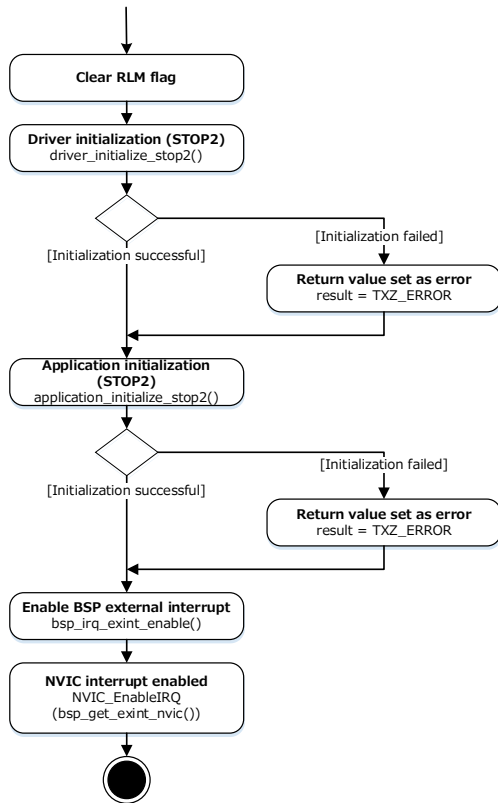

When STOP2_EQIPPED is defined

7.24. Interrupt

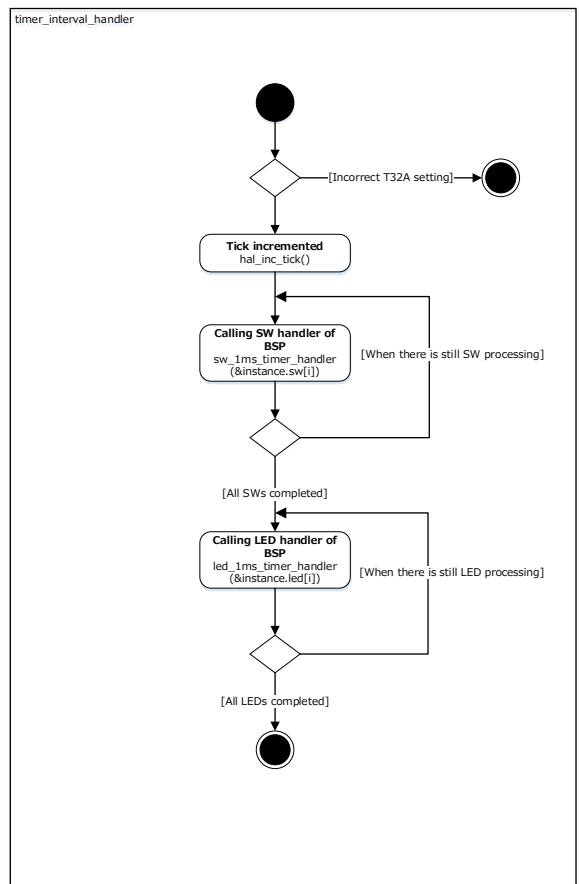
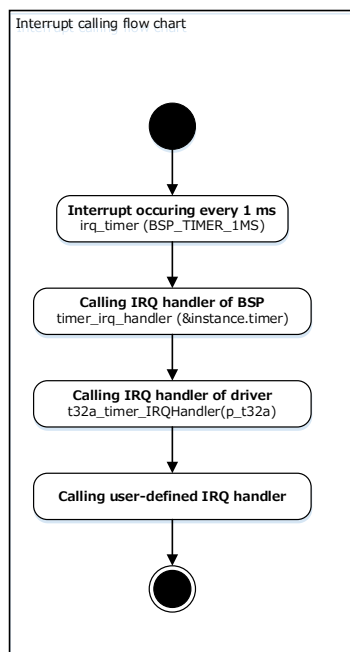
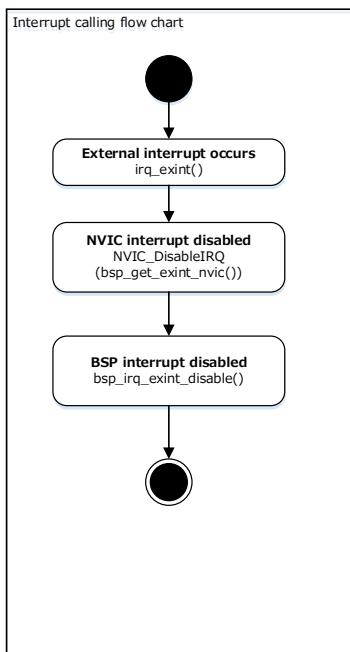

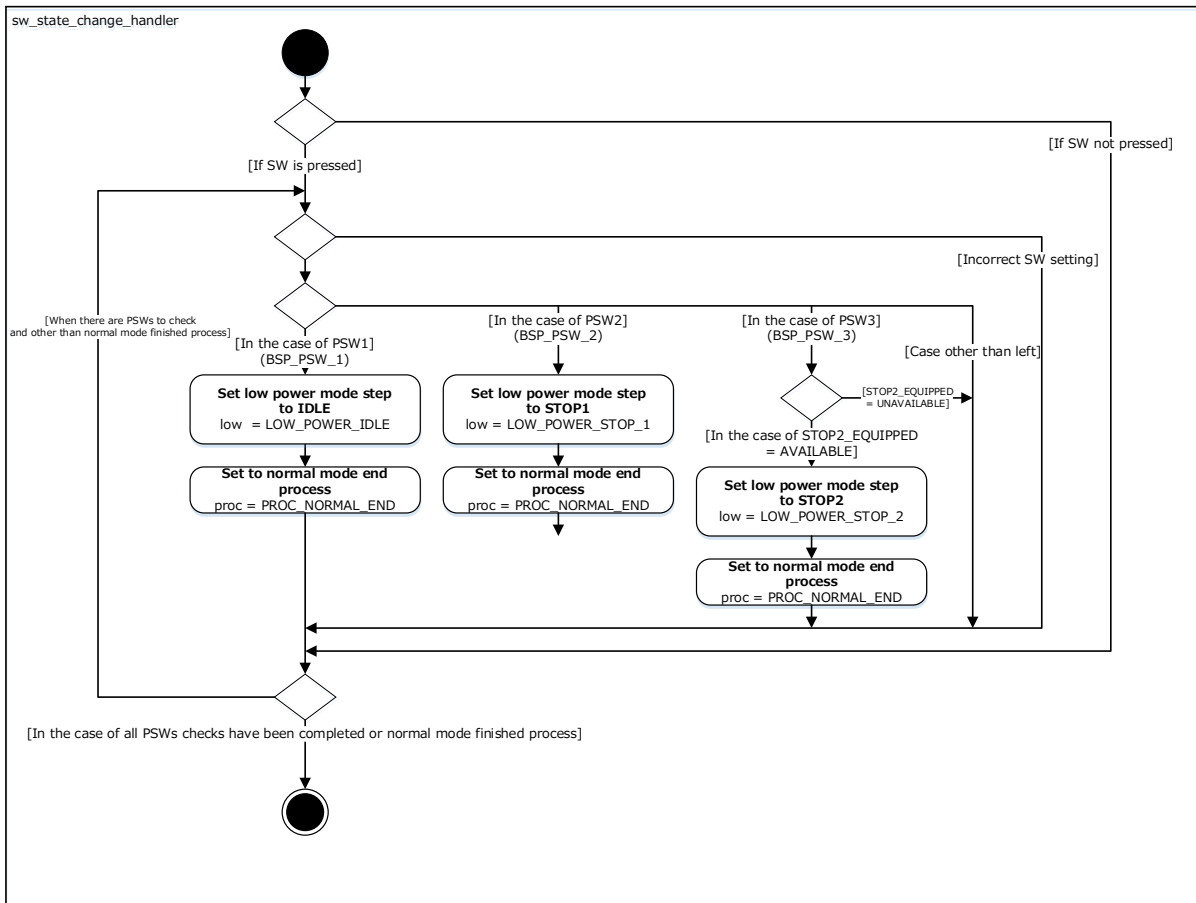

8. Revision History

Revision	Date	Description
1.0	2023-10-16	First release

RESTRICTIONS ON PRODUCT USE

Toshiba Corporation and its subsidiaries and affiliates are collectively referred to as "TOSHIBA". Hardware, software and systems described in this document are collectively referred to as "Product".

- TOSHIBA reserves the right to make changes to the information in this document and related Product without notice.
- This document and any information herein may not be reproduced without prior written permission from TOSHIBA. Even with TOSHIBA's written permission, reproduction is permissible only if reproduction is without alteration/omission.
- Though TOSHIBA works continually to improve Product's quality and reliability, Product can malfunction or fail. Customers are responsible for complying with safety standards and for providing adequate designs and safeguards for their hardware, software and systems which minimize risk and avoid situations in which a malfunction or failure of Product could cause loss of human life, bodily injury or damage to property, including data loss or corruption. Before customers use the Product, create designs including the Product, or incorporate the Product into their own applications, customers must also refer to and comply with (a) the latest versions of all relevant TOSHIBA information, including without limitation, this document, the specifications, the data sheets and application notes for Product and the precautions and conditions set forth in the "TOSHIBA Semiconductor Reliability Handbook" and (b) the instructions for the application with which the Product will be used with or for. Customers are solely responsible for all aspects of their own product design or applications, including but not limited to (a) determining the appropriateness of the use of this Product in such design or applications; (b) evaluating and determining the applicability of any information contained in this document, or in charts, diagrams, programs, algorithms, sample application circuits, or any other referenced documents; and (c) validating all operating parameters for such designs and applications. **TOSHIBA ASSUMES NO LIABILITY FOR CUSTOMERS' PRODUCT DESIGN OR APPLICATIONS.**
- **PRODUCT IS NEITHER INTENDED NOR WARRANTED FOR USE IN EQUIPMENTS OR SYSTEMS THAT REQUIRE EXTRAORDINARILY HIGH LEVELS OF QUALITY AND/OR RELIABILITY, AND/OR A MALFUNCTION OR FAILURE OF WHICH MAY CAUSE LOSS OF HUMAN LIFE, BODILY INJURY, SERIOUS PROPERTY DAMAGE AND/OR SERIOUS PUBLIC IMPACT ("UNINTENDED USE").** Except for specific applications as expressly stated in this document, Unintended Use includes, without limitation, equipment used in nuclear facilities, equipment used in the aerospace industry, lifesaving and/or life supporting medical equipment, equipment used for automobiles, trains, ships and other transportation, traffic signaling equipment, equipment used to control combustions or explosions, safety devices, elevators and escalators, and devices related to power plant. **IF YOU USE PRODUCT FOR UNINTENDED USE, TOSHIBA ASSUMES NO LIABILITY FOR PRODUCT.** For details, please contact your TOSHIBA sales representative or contact us via our website.
- Do not disassemble, analyze, reverse-engineer, alter, modify, translate or copy Product, whether in whole or in part.
- Product shall not be used for or incorporated into any products or systems whose manufacture, use, or sale is prohibited under any applicable laws or regulations.
- The information contained herein is presented only as guidance for Product use. No responsibility is assumed by TOSHIBA for any infringement of patents or any other intellectual property rights of third parties that may result from the use of Product. No license to any intellectual property right is granted by this document, whether express or implied, by estoppel or otherwise.
- **ABSENT A WRITTEN SIGNED AGREEMENT, EXCEPT AS PROVIDED IN THE RELEVANT TERMS AND CONDITIONS OF SALE FOR PRODUCT, AND TO THE MAXIMUM EXTENT ALLOWABLE BY LAW, TOSHIBA (1) ASSUMES NO LIABILITY WHATSOEVER, INCLUDING WITHOUT LIMITATION, INDIRECT, CONSEQUENTIAL, SPECIAL, OR INCIDENTAL DAMAGES OR LOSS, INCLUDING WITHOUT LIMITATION, LOSS OF PROFITS, LOSS OF OPPORTUNITIES, BUSINESS INTERRUPTION AND LOSS OF DATA, AND (2) DISCLAIMS ANY AND ALL EXPRESS OR IMPLIED WARRANTIES AND CONDITIONS RELATED TO SALE, USE OF PRODUCT, OR INFORMATION, INCLUDING WARRANTIES OR CONDITIONS OF MERCHANTABILITY, FITNESS FOR A PARTICULAR PURPOSE, ACCURACY OF INFORMATION, OR NONINFRINGEMENT.**
- Do not use or otherwise make available Product or related software or technology for any military purposes, including without limitation, for the design, development, use, stockpiling or manufacturing of nuclear, chemical, or biological weapons or missile technology products (mass destruction weapons). Product and related software and technology may be controlled under the applicable export laws and regulations including, without limitation, the Japanese Foreign Exchange and Foreign Trade Law and the U.S. Export Administration Regulations. Export and re-export of Product or related software or technology are strictly prohibited except in compliance with all applicable export laws and regulations.
- Please contact your TOSHIBA sales representative for details as to environmental matters such as the RoHS compatibility of Product. Please use Product in compliance with all applicable laws and regulations that regulate the inclusion or use of controlled substances, including without limitation, the EU RoHS Directive. **TOSHIBA ASSUMES NO LIABILITY FOR DAMAGES OR LOSSES OCCURRING AS A RESULT OF NONCOMPLIANCE WITH APPLICABLE LAWS AND REGULATIONS.**

Toshiba Electronic Devices & Storage Corporation

<https://toshiba.semicon-storage.com/>