

## Application Note

# I2C MASTER TRANS (I2C-B)

Arm and Keil are registered trademarks of Arm Limited (or its subsidiaries) in the US and/or elsewhere.

All other company names, product names, and service names mentioned herein may be trademarks of their respective companies.

## Table of Contents

|  |           |
|--|-----------|
| Table of Contents.....                         | 2         |
| 1. Preface .....                               | 3         |
| 2. Technical Term .....                        | 3         |
| 3. Reference Document .....                    | 3         |
| 4. Target Sample Program .....                 | 4         |
| 5. Configuration Diagram .....                 | 4         |
| 6. Sample Program:I2C_MASTER_TRANS .....       | 5         |
| 6.1. Outlines of Operation.....                | 5         |
| 6.2. Function to Use.....                      | 5         |
| 6.3. Interrupt to Use .....                    | 5         |
| 6.4. Configuration.....                        | 5         |
| 6.5. Example of Terminal Emulator Output ..... | 5         |
| 7. Activity diagram.....                       | 6         |
| 7.1. main .....                                | 6         |
| 7.2. variable_initialize.....                  | 7         |
| 7.3. application_initialize .....              | 8         |
| 7.4. configuration .....                       | 9         |
| 7.5. clear_master_tx_data .....                | 9         |
| 7.6. ts_i2c_initialize.....                    | 10        |
| 7.7. ts_i2c_master_non_blocking_write .....    | 11        |
| 7.8. Interrupt.....                            | 12        |
| 8. Revision History .....                      | 14        |
| <b>RESTRICTIONS ON PRODUCT USE .....</b>       | <b>15</b> |

### 1. Preface

This application note describes sample software for I2C\_MASTER\_TRANS using Inter-Integrated Circuit (I2C).

This document helps the user check operation of a product under development and develop its program.

### 2. Technical Term

| Term/Abbreviation | Definition                       |
|-------------------|----------------------------------|
| BSP               | Board Support Package            |
| CG                | Clock Control and Operation Mode |
| I2C               | Inter-Integrated Circuit         |
| Timer             | T32A:32-bit Timer Event Counter  |

### 3. Reference Document

| Document                           | Notes  |
|------------------------------------|--|
| Data sheet                         | Refer to the data sheet of MCU to be used.           |
| Reference manual                   | Refer to the reference manual of each IP to be used. |
| Application note<br>MCU User Guide | Refer to the MCU user guide to be used.              |

## 4. Target Sample Program

| Sample Program   | Outline                                       |
|------------------|---|
| I2C_MASTER_TRANS | Sample program of I2C function (Master Trans) |

## 5. Configuration Diagram

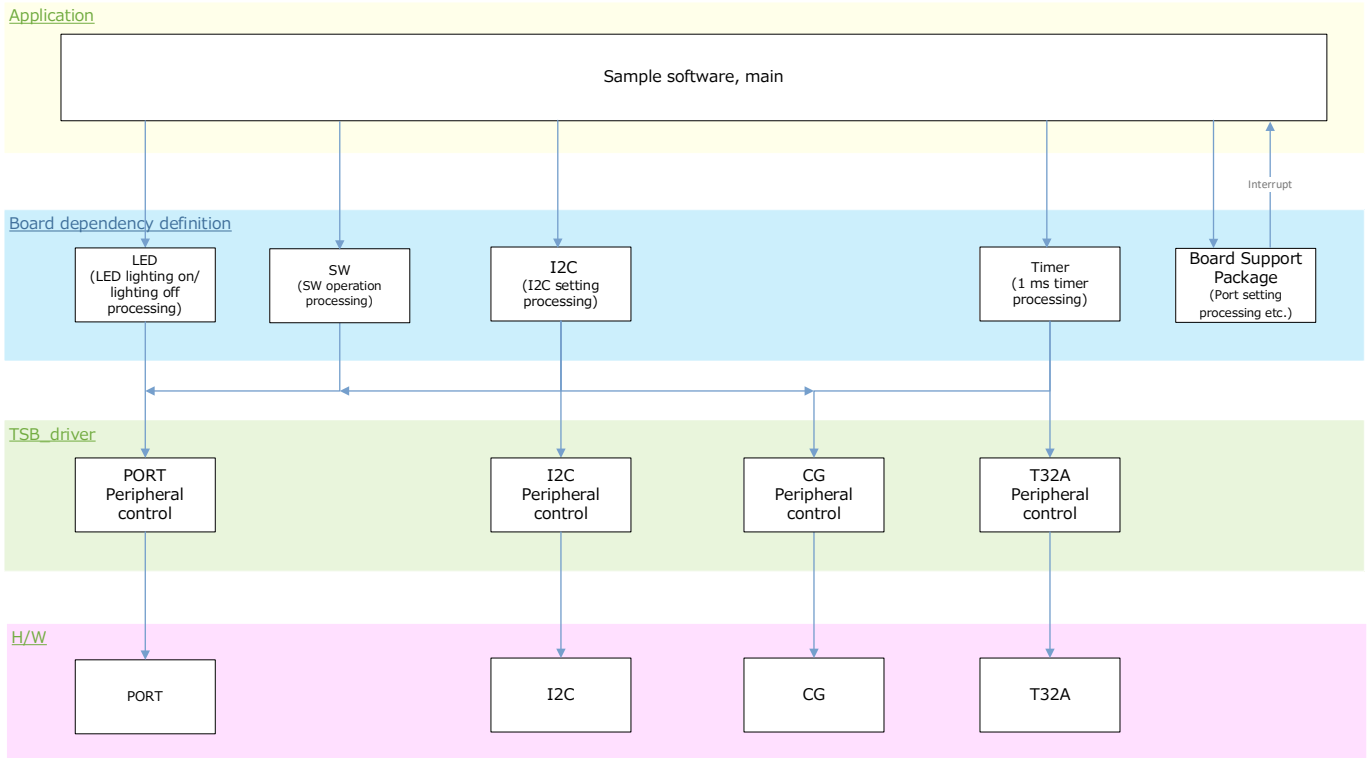

## 6. Sample Program:I2C\_MASTER\_TRANS

This sample software that switches the LED on and off each time data reception is completed using the Master transmission processing of the I2C communication function.

### 6.1. Outlines of Operation

Turn off BSP\_LED\_1 and BSP\_LED\_3.

When BSP\_PSW\_1 is pressed, a character string will be sent.

The character string to send is set in the 6.4 configuration.

After transmission, the lighting state (turn on / turn off) of BSP\_LED\_1 is switched.

When an error occurs, BSP\_LED\_3 is turn on.

### 6.2. Function to Use

The functions to use are as follows:

For the Port assignment of each BSP channel, refer to the MCU user guide.

| IP                | Channel          | Objective           |
|-------------------|------------------|---------------------|
| I2C               | BSP_I2C_1        | I2C communication   |
| T32A              | BSP_T32A_TIMER_1 | Interval timer      |
| PORT(Push-Switch) | BSP_PSW_1        | Event trigger       |
| PORT(LED)         | BSP_LED_1        | For operation check |
|                   | BSP_LED_3        | For operation check |

### 6.3. Interrupt to Use

| Interrupt  | Outlines  |
|------------|---|
| INTT32A00A | T32A Timer A<br>Timer counter increment every 1ms for Switch processing |

### 6.4. Configuration

“main.c” configuration setting.

| Configuration | Current Value | Description                               |
|---------------|---------------|---|
| Character row | *1            | In this sample, it is defined by MCU_NAME |

\*1 For SBK-M4KN, “TMPM4KNFYA”

### 6.5. Example of Terminal Emulator Output

Nothing.

## 7. Activity diagram

### 7.1. main

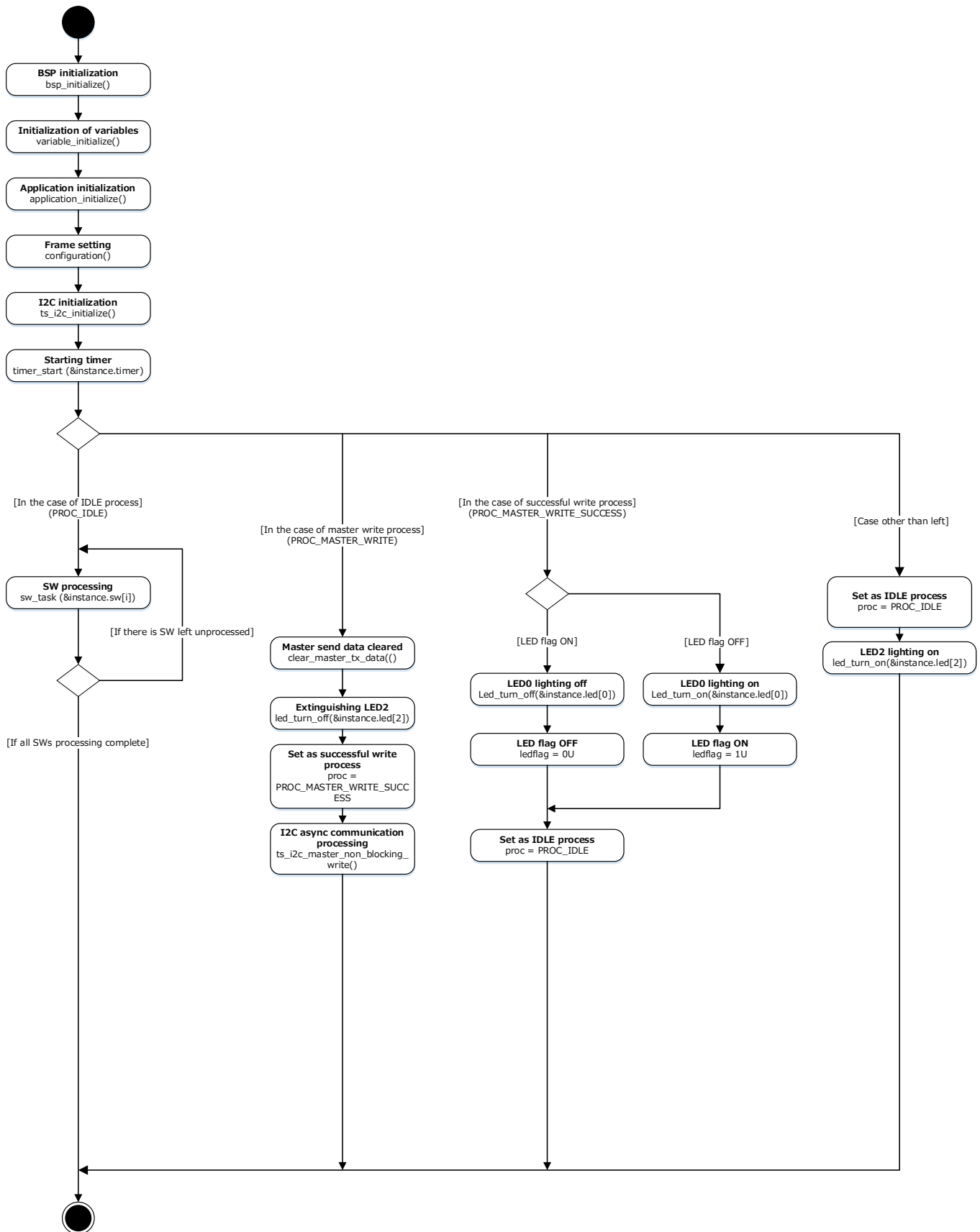

### 7.2. variable\_initialize

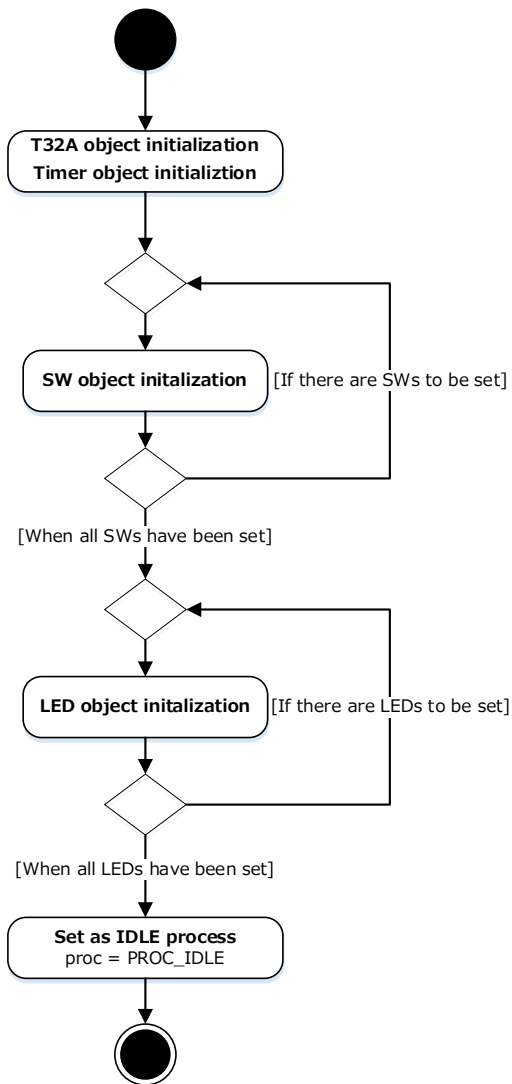

### 7.3. application\_initialize

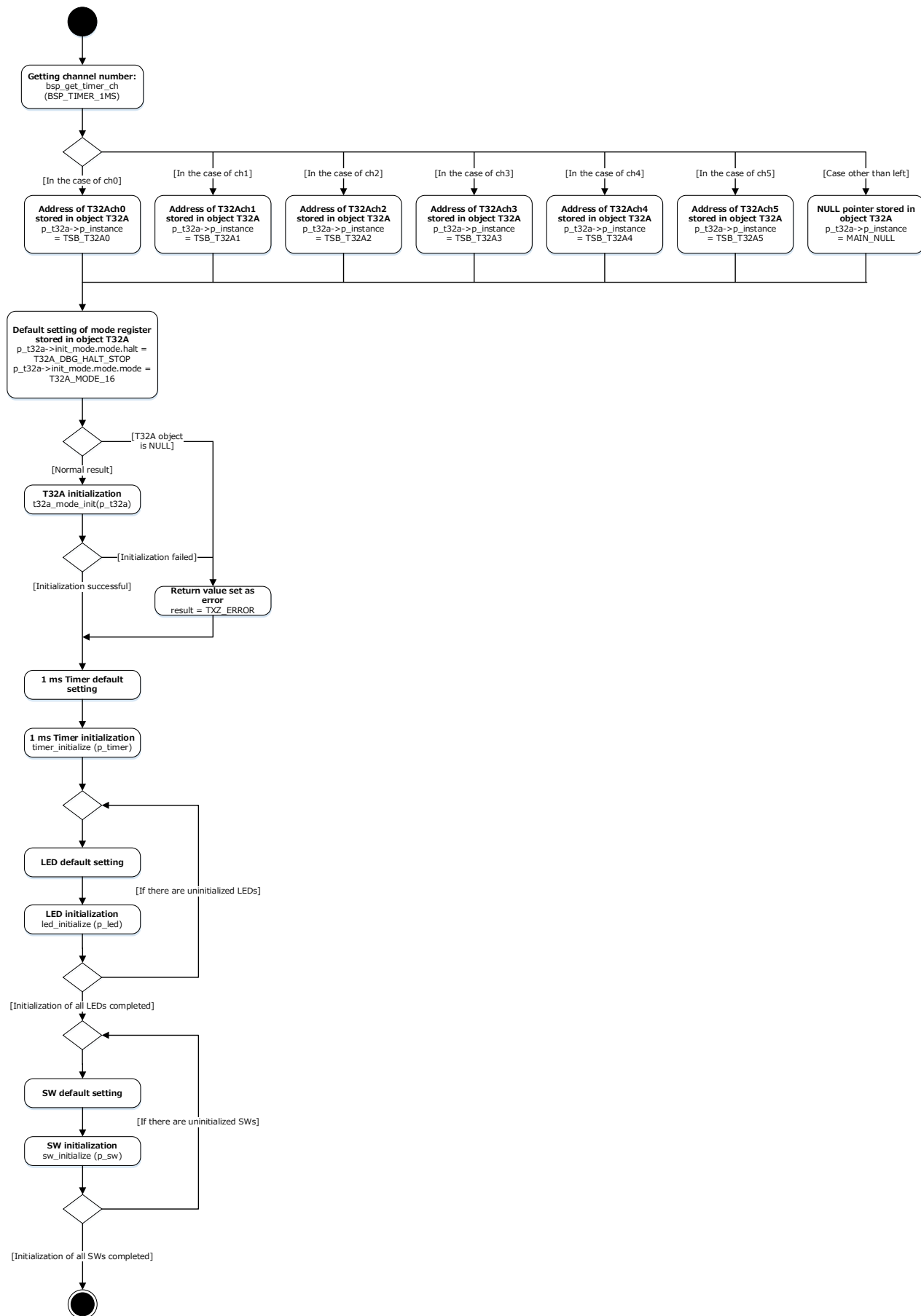



## 7.4. configuration

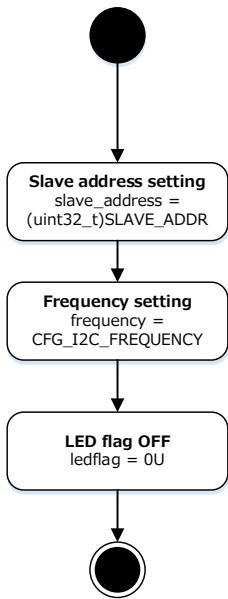

## 7.5. clear\_master\_tx\_data

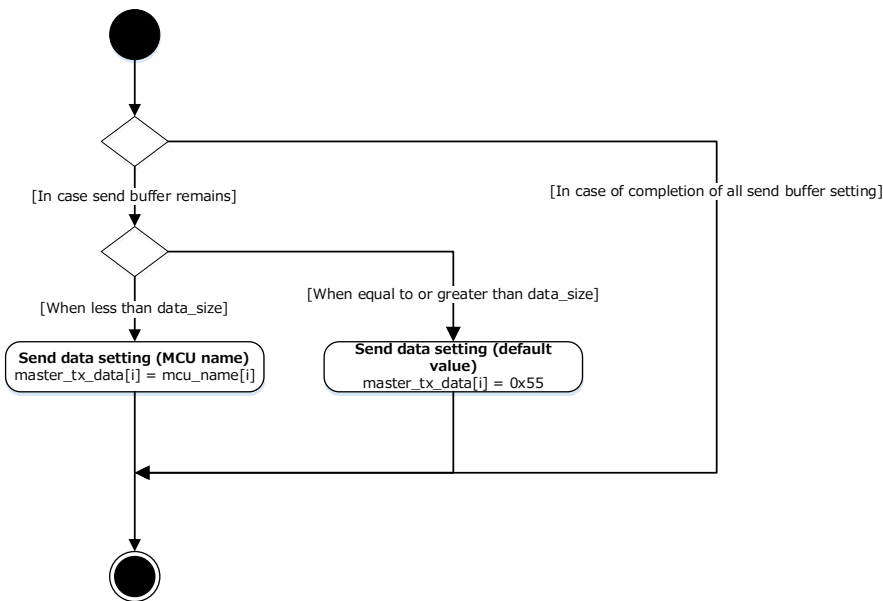

### 7.6. ts\_i2c\_initialize

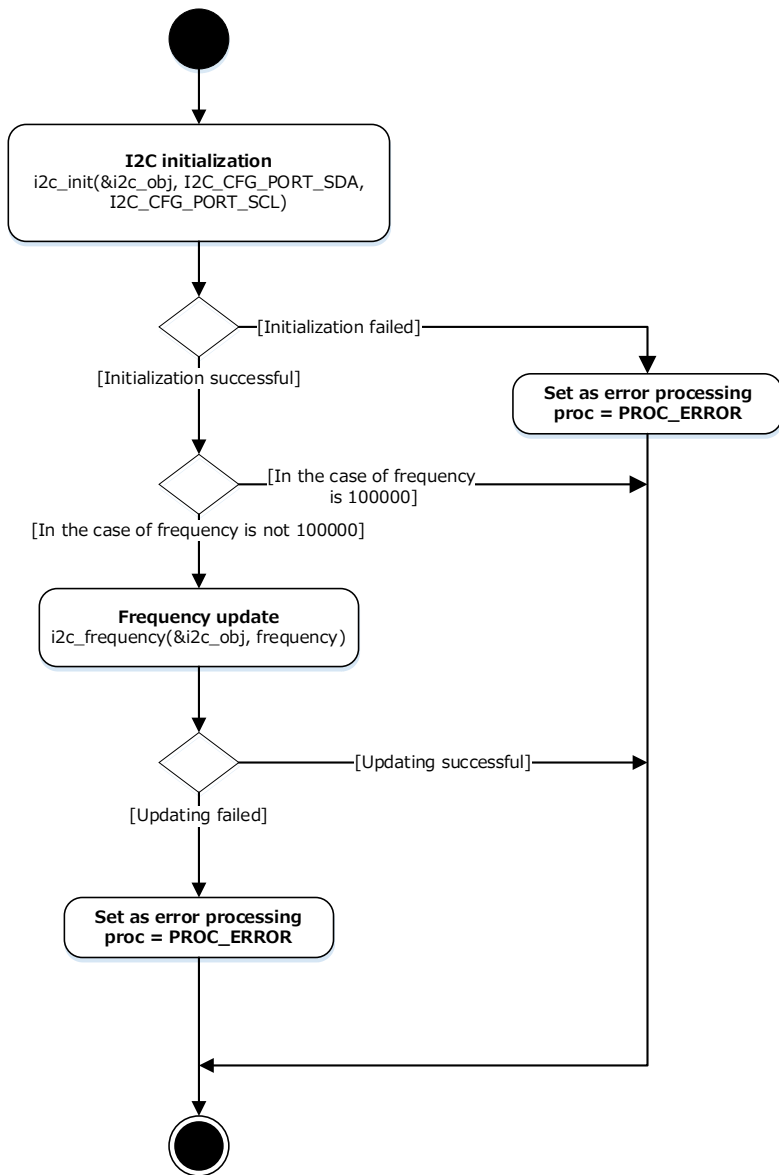

### 7.7. ts\_i2c\_master\_non\_blocking\_write

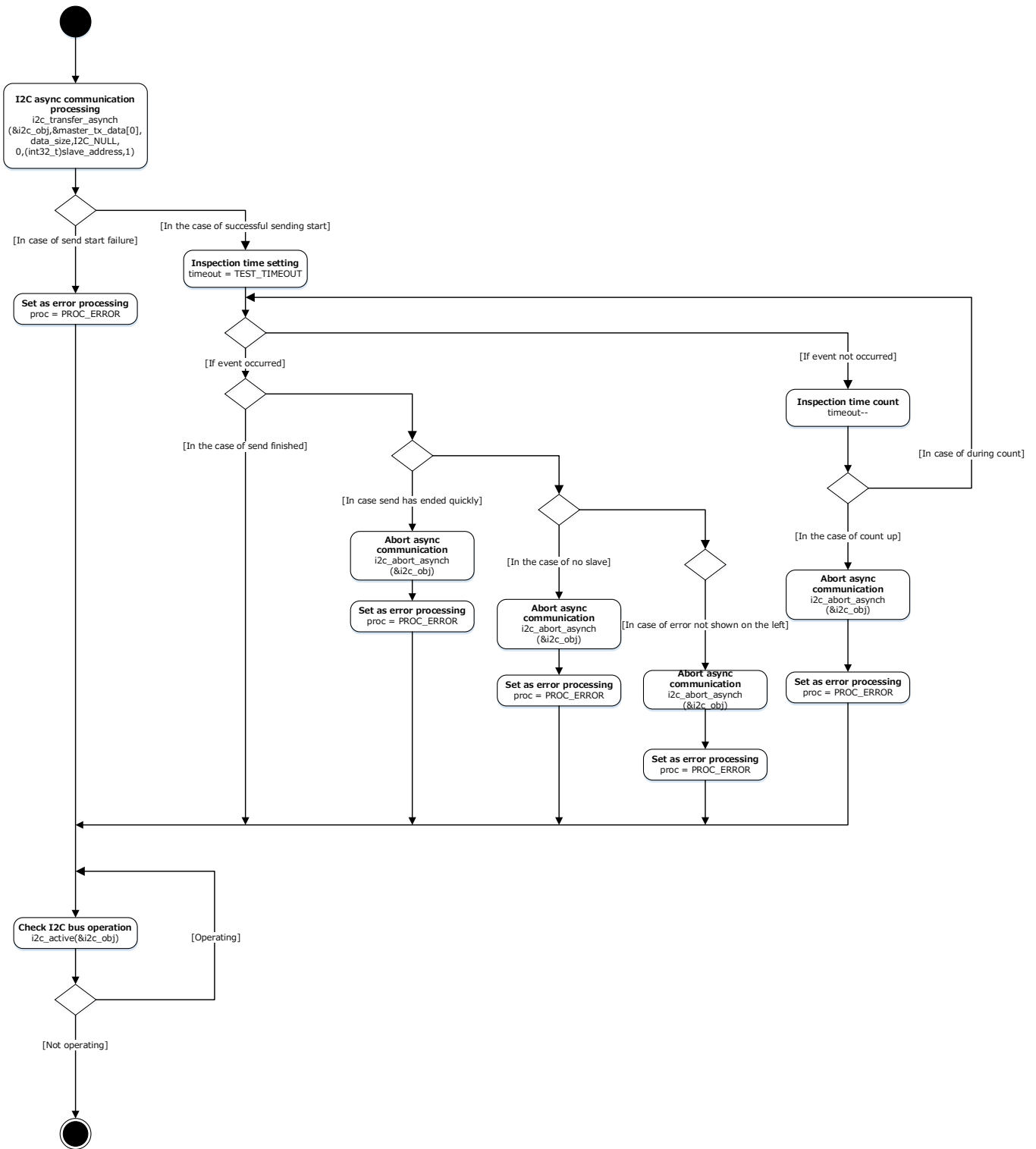

### 7.8. Interrupt

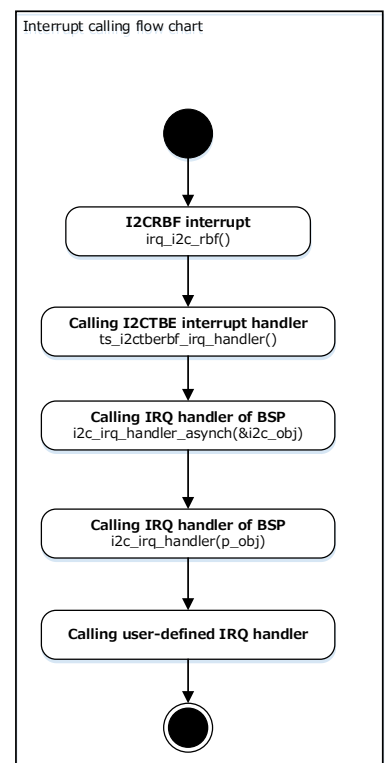
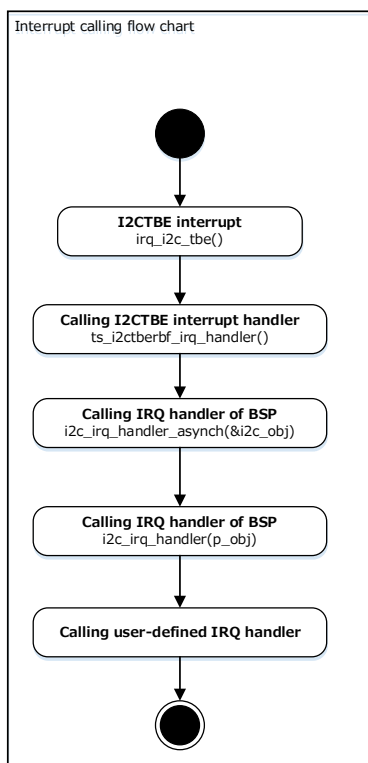
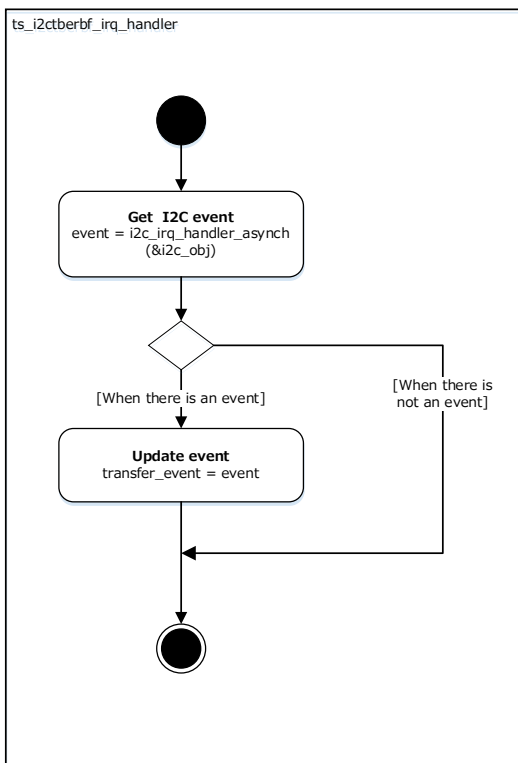
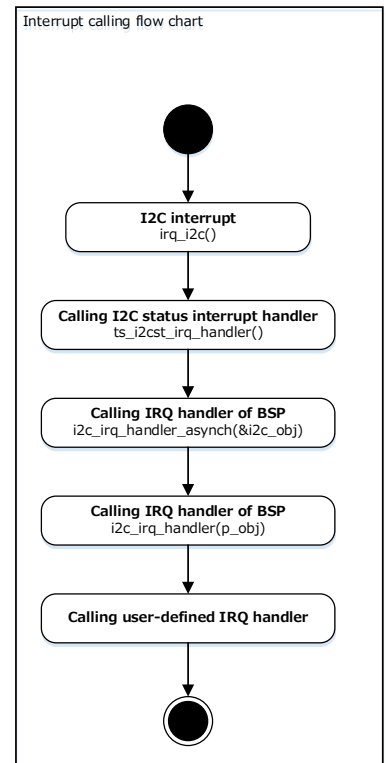
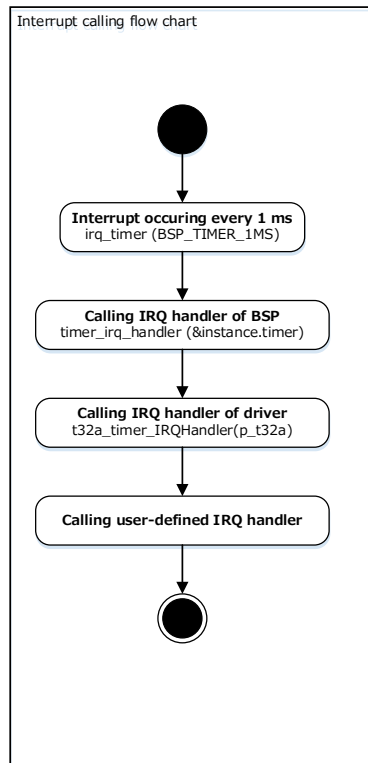
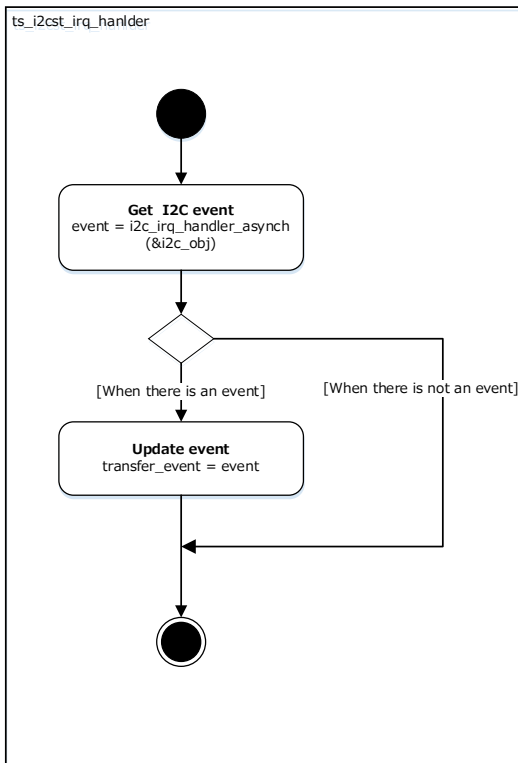

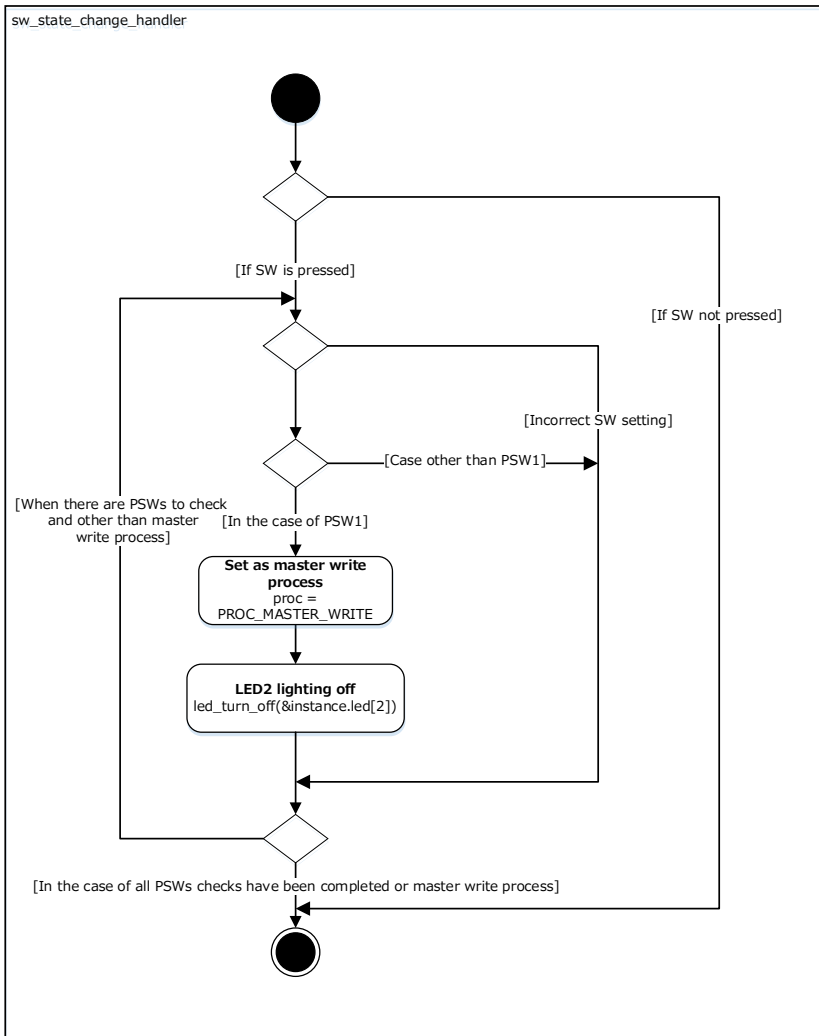
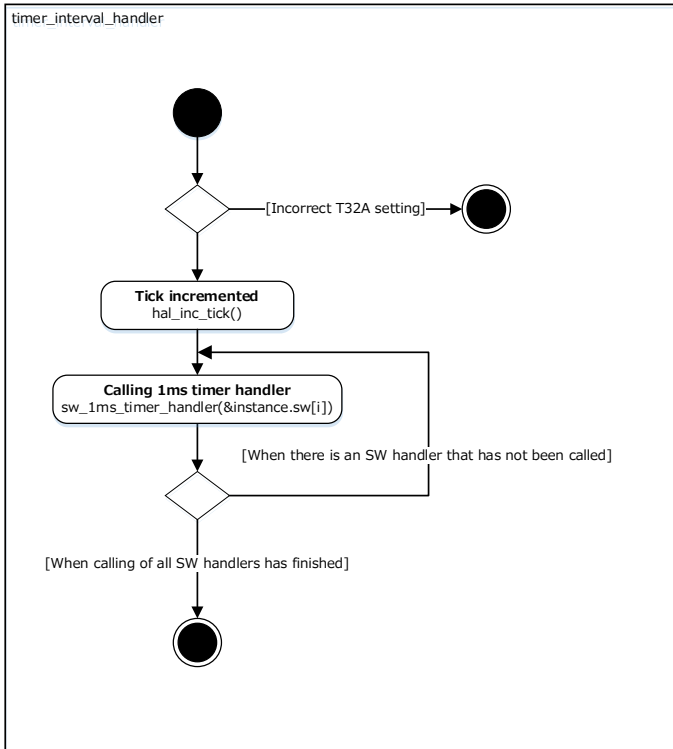

## 8. Revision History

| Revision | Date       | Description   |
|----------|------------|---------------|
| 1.0      | 2023-10-16 | First release |

### RESTRICTIONS ON PRODUCT USE

Toshiba Corporation and its subsidiaries and affiliates are collectively referred to as "TOSHIBA". Hardware, software and systems described in this document are collectively referred to as "Product".

- TOSHIBA reserves the right to make changes to the information in this document and related Product without notice.
- This document and any information herein may not be reproduced without prior written permission from TOSHIBA. Even with TOSHIBA's written permission, reproduction is permissible only if reproduction is without alteration/omission.
- Though TOSHIBA works continually to improve Product's quality and reliability, Product can malfunction or fail. Customers are responsible for complying with safety standards and for providing adequate designs and safeguards for their hardware, software and systems which minimize risk and avoid situations in which a malfunction or failure of Product could cause loss of human life, bodily injury or damage to property, including data loss or corruption. Before customers use the Product, create designs including the Product, or incorporate the Product into their own applications, customers must also refer to and comply with (a) the latest versions of all relevant TOSHIBA information, including without limitation, this document, the specifications, the data sheets and application notes for Product and the precautions and conditions set forth in the "TOSHIBA Semiconductor Reliability Handbook" and (b) the instructions for the application with which the Product will be used with or for. Customers are solely responsible for all aspects of their own product design or applications, including but not limited to (a) determining the appropriateness of the use of this Product in such design or applications; (b) evaluating and determining the applicability of any information contained in this document, or in charts, diagrams, programs, algorithms, sample application circuits, or any other referenced documents; and (c) validating all operating parameters for such designs and applications. **TOSHIBA ASSUMES NO LIABILITY FOR CUSTOMERS' PRODUCT DESIGN OR APPLICATIONS.**
- **PRODUCT IS NEITHER INTENDED NOR WARRANTED FOR USE IN EQUIPMENTS OR SYSTEMS THAT REQUIRE EXTRAORDINARILY HIGH LEVELS OF QUALITY AND/OR RELIABILITY, AND/OR A MALFUNCTION OR FAILURE OF WHICH MAY CAUSE LOSS OF HUMAN LIFE, BODILY INJURY, SERIOUS PROPERTY DAMAGE AND/OR SERIOUS PUBLIC IMPACT ("UNINTENDED USE").** Except for specific applications as expressly stated in this document, Unintended Use includes, without limitation, equipment used in nuclear facilities, equipment used in the aerospace industry, lifesaving and/or life supporting medical equipment, equipment used for automobiles, trains, ships and other transportation, traffic signaling equipment, equipment used to control combustions or explosions, safety devices, elevators and escalators, and devices related to power plant. **IF YOU USE PRODUCT FOR UNINTENDED USE, TOSHIBA ASSUMES NO LIABILITY FOR PRODUCT.** For details, please contact your TOSHIBA sales representative or contact us via our website.
- Do not disassemble, analyze, reverse-engineer, alter, modify, translate or copy Product, whether in whole or in part.
- Product shall not be used for or incorporated into any products or systems whose manufacture, use, or sale is prohibited under any applicable laws or regulations.
- The information contained herein is presented only as guidance for Product use. No responsibility is assumed by TOSHIBA for any infringement of patents or any other intellectual property rights of third parties that may result from the use of Product. No license to any intellectual property right is granted by this document, whether express or implied, by estoppel or otherwise.
- **ABSENT A WRITTEN SIGNED AGREEMENT, EXCEPT AS PROVIDED IN THE RELEVANT TERMS AND CONDITIONS OF SALE FOR PRODUCT, AND TO THE MAXIMUM EXTENT ALLOWABLE BY LAW, TOSHIBA (1) ASSUMES NO LIABILITY WHATSOEVER, INCLUDING WITHOUT LIMITATION, INDIRECT, CONSEQUENTIAL, SPECIAL, OR INCIDENTAL DAMAGES OR LOSS, INCLUDING WITHOUT LIMITATION, LOSS OF PROFITS, LOSS OF OPPORTUNITIES, BUSINESS INTERRUPTION AND LOSS OF DATA, AND (2) DISCLAIMS ANY AND ALL EXPRESS OR IMPLIED WARRANTIES AND CONDITIONS RELATED TO SALE, USE OF PRODUCT, OR INFORMATION, INCLUDING WARRANTIES OR CONDITIONS OF MERCHANTABILITY, FITNESS FOR A PARTICULAR PURPOSE, ACCURACY OF INFORMATION, OR NONINFRINGEMENT.**
- Do not use or otherwise make available Product or related software or technology for any military purposes, including without limitation, for the design, development, use, stockpiling or manufacturing of nuclear, chemical, or biological weapons or missile technology products (mass destruction weapons). Product and related software and technology may be controlled under the applicable export laws and regulations including, without limitation, the Japanese Foreign Exchange and Foreign Trade Law and the U.S. Export Administration Regulations. Export and re-export of Product or related software or technology are strictly prohibited except in compliance with all applicable export laws and regulations.
- Please contact your TOSHIBA sales representative for details as to environmental matters such as the RoHS compatibility of Product. Please use Product in compliance with all applicable laws and regulations that regulate the inclusion or use of controlled substances, including without limitation, the EU RoHS Directive. **TOSHIBA ASSUMES NO LIABILITY FOR DAMAGES OR LOSSES OCCURRING AS A RESULT OF NONCOMPLIANCE WITH APPLICABLE LAWS AND REGULATIONS.**

**Toshiba Electronic Devices & Storage Corporation**

<https://toshiba.semicon-storage.com/>