

Inkjet Printer

Solution Proposal by Toshiba

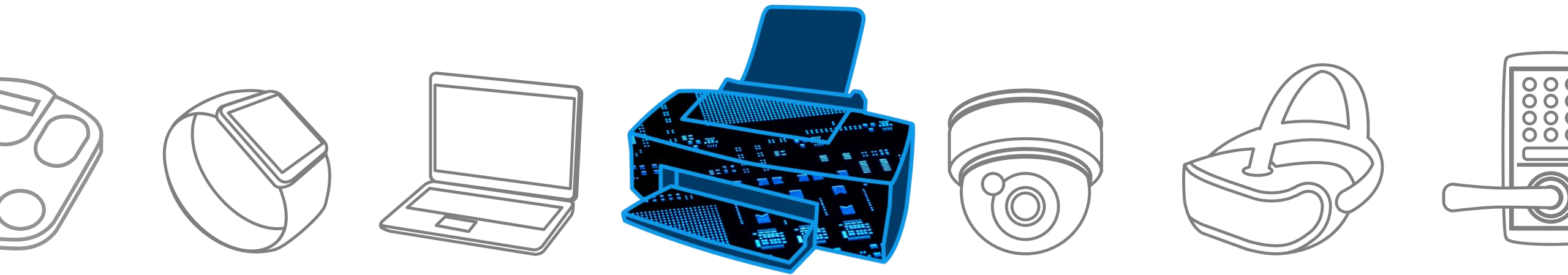

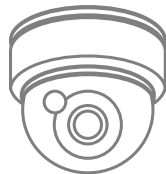
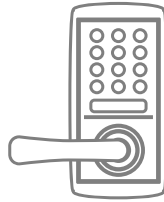

Toshiba Electronic Devices & Storage Corporation provides comprehensive device solutions to customers developing new products by applying its thorough understanding of the systems acquired through the analysis of basic product designs.

Block Diagram

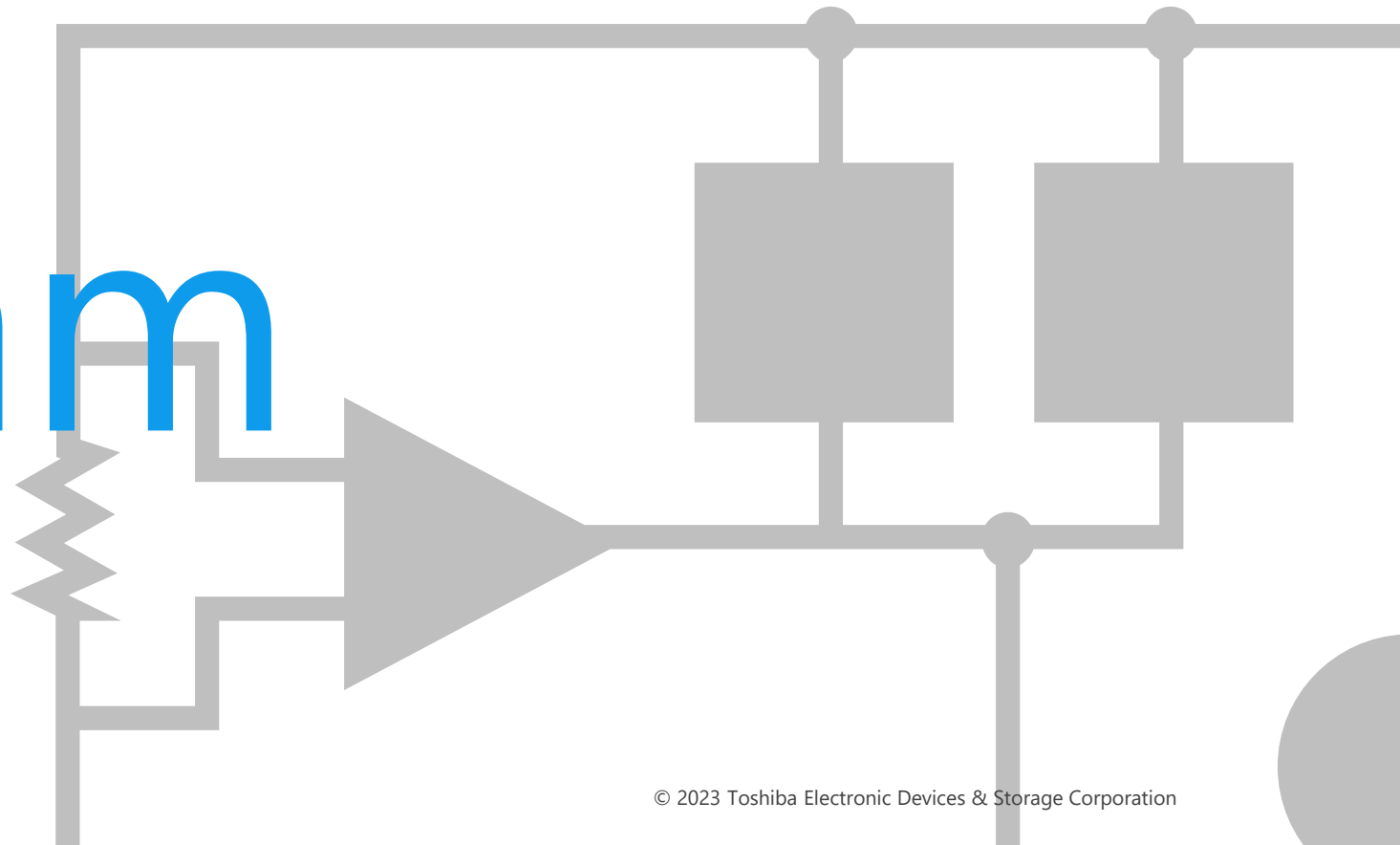

Inkjet Printer Overall block diagram

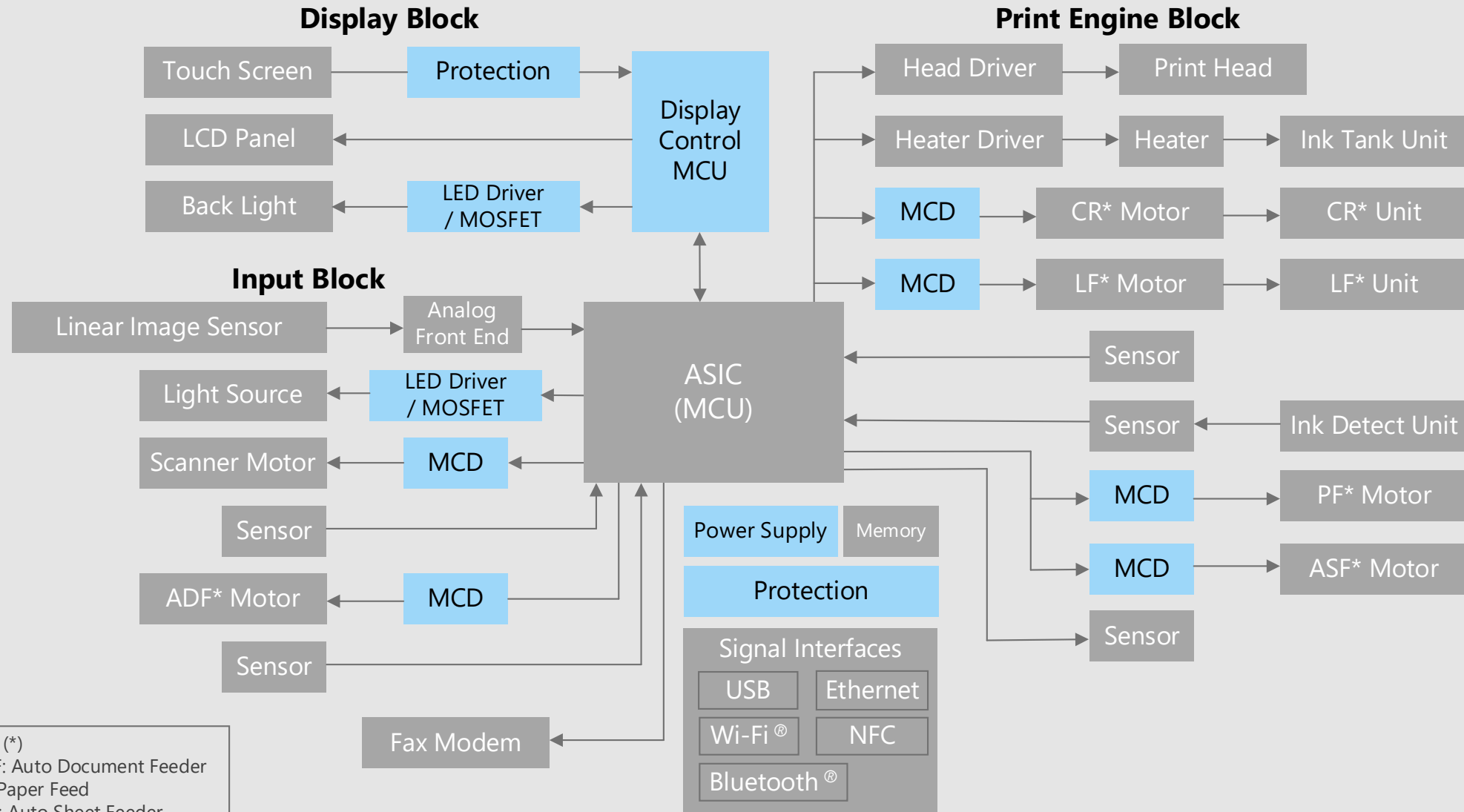

Note (*)
 ADF: Auto Document Feeder
 PF: Paper Feed
 ASF: Auto Sheet Feeder
 CR: Carriage Return
 LF: Line Feed

Inkjet Printer Detail of the power supply circuit

Power supply circuit

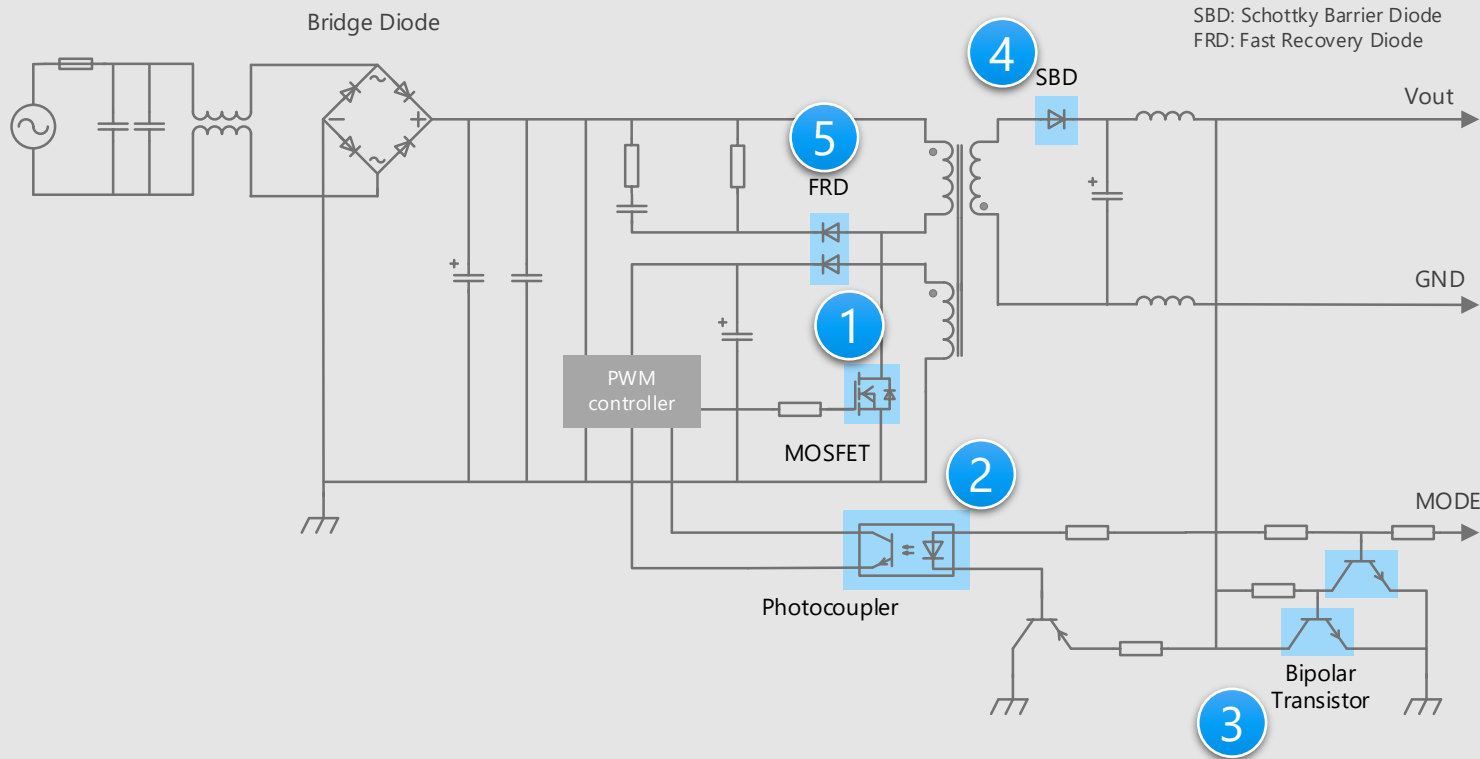

* Click the number in the circuit diagram to jump to the detailed description page

Criteria for device selection

- Transistor output photocoupler is suitable for isolation of feedback signal from the secondary side.
- By using a MOSFET with low on-resistance and high heat dissipation efficiency, a set having low heat generation and low power consumption is realized.
- Small package products contribute to the reduction of circuit board area.

Proposals from Toshiba

- **Suitable for high efficiency power supply switching**
π-MOS Series MOSFET 1
- **Photocoupler with excellent environmental resistance**
Transistor output photocoupler 2
- **For high speed switching and compact surface mounting**
Bipolar transistor 3
- **High speed, low loss**
Schottky barrier diode 4
- **High reverse voltage and short reverse recovery time**
Fast recovery diode 5

Inkjet Printer Detail of display / scanner block

Display block

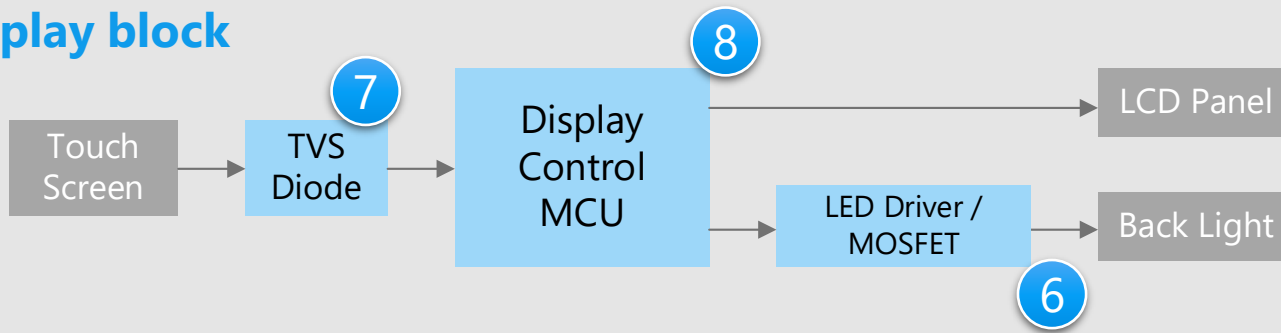

Scanner block

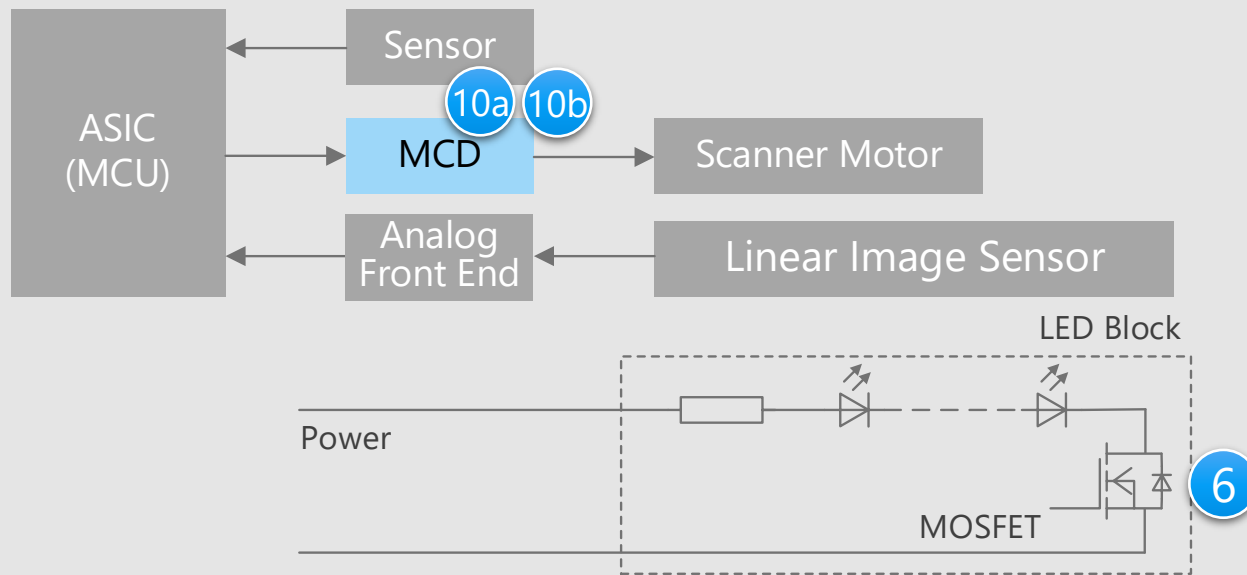

* Click the number in the circuit diagram to jump to the detailed description page

Criteria for device selection

- Small package products contribute to the reduction of circuit board area.
- TVS diodes are suitable for absorbing the static electricity from external terminals to prevent circuit malfunction and device breakdown.
- Document scanning requires fine control of the light source.

Proposals from Toshiba

- **Realizes low on-resistance and low power consumption set**
Small signal MOSFET 6
- **High speed signal line protection with low capacitance characteristics**
TVS diode 7
- **All in one chip with a built-in LCD driver**
MCU TPM061FWFG 8
- **High precision current control for a scanner**
Stepping motor driver 10a 10b

USB circuit

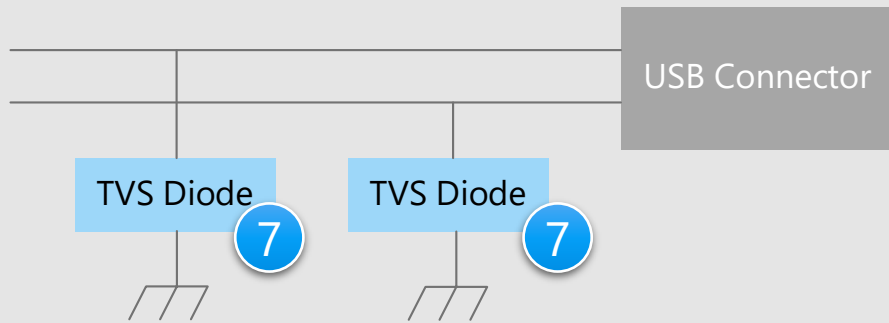

ADF block

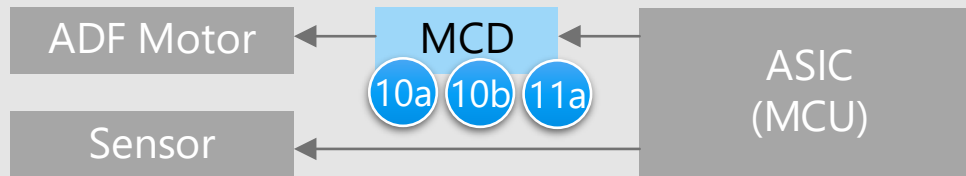

Criteria for device selection

- Small package products contribute to the reduction of circuit board area.
- TVS diodes are suitable for absorbing the static electricity from external terminals to prevent circuit malfunction and device breakdown.
- Document feeding requires fine control.

Proposals from Toshiba

- **High speed signal line protection with low capacitance characteristics**
TVS diode
- **High precision current control for ADF**
Stepping motor driver
Brushed DC motor driver



* [Click the number in the circuit diagram to jump to the detailed description page](#)

Inkjet Printer Detail of print engine block

Print engine block

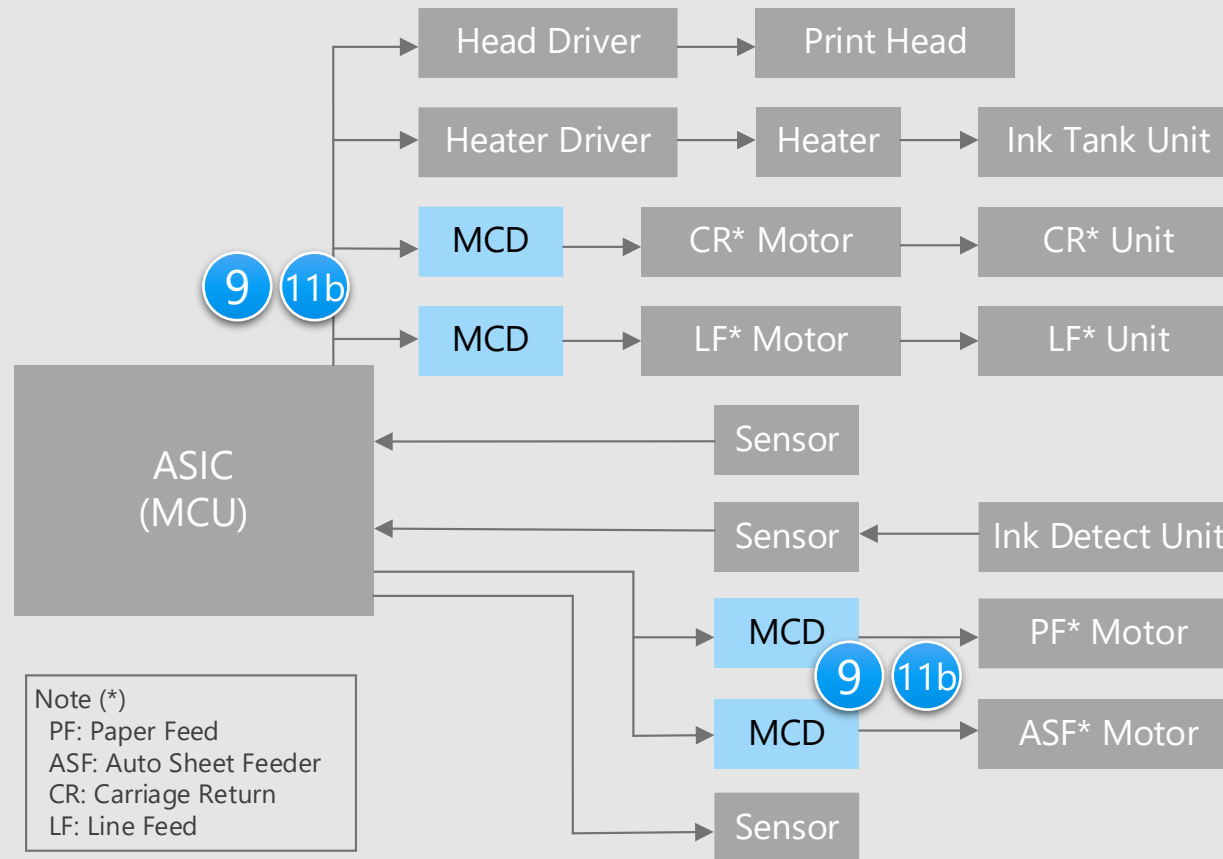

* Click the number in the circuit diagram to jump to the detailed description page

Criteria for device selection

- Feeding printing a document and a paper requires high precision paper position control.

Proposals from Toshiba

- **Positioning sorter and sheet with high accuracy**
Stepping motor driver with a built-in AGC
Brushed DC motor driver

Recommended Devices

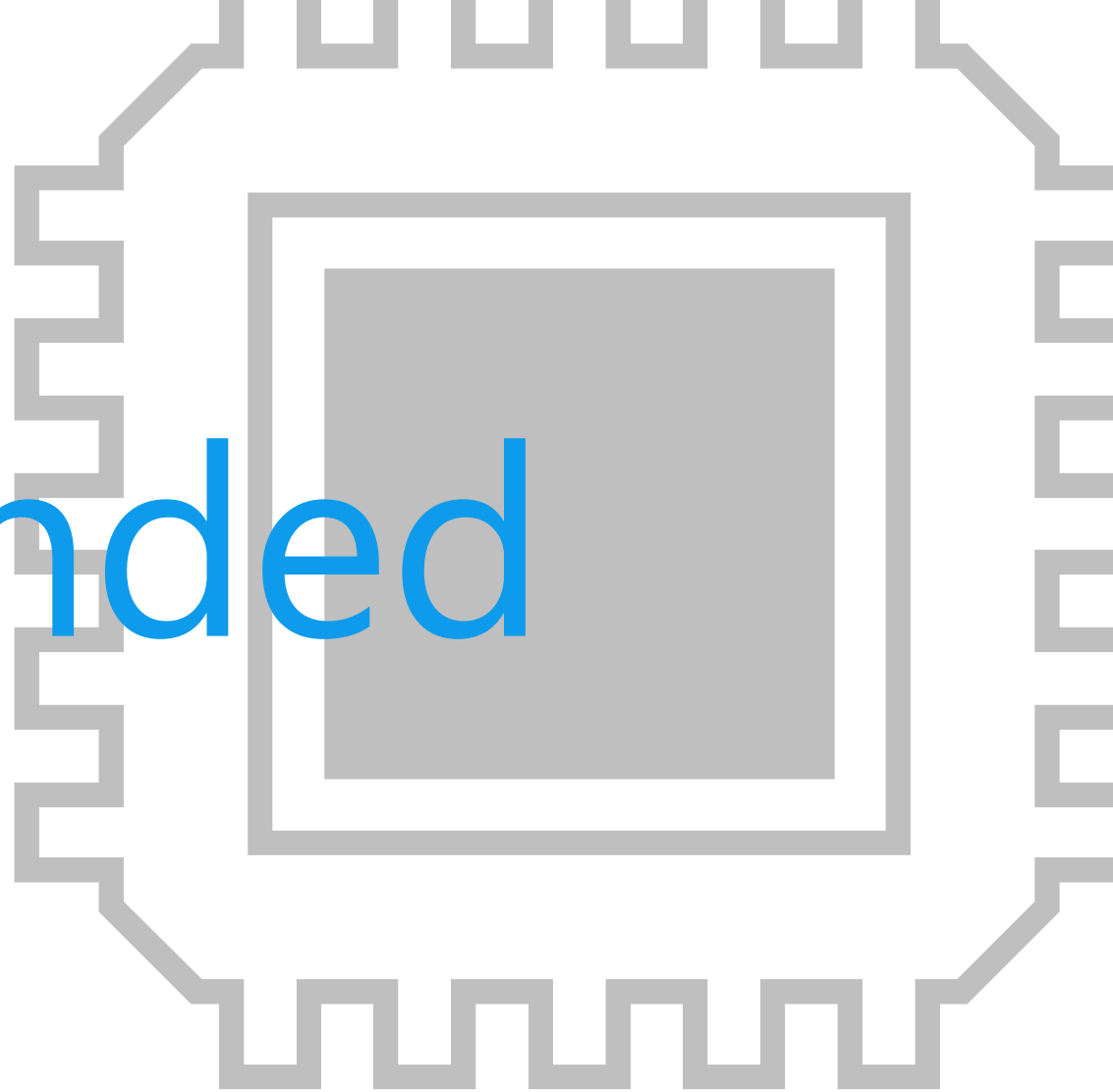

Device solutions to address customer needs

As described above, in the design of Inkjet Printer, "**Miniaturization of circuit boards**", "**Low power consumption of set**" and "**Robust operation**" are important factors. Toshiba's proposals are based on these three solution perspectives.

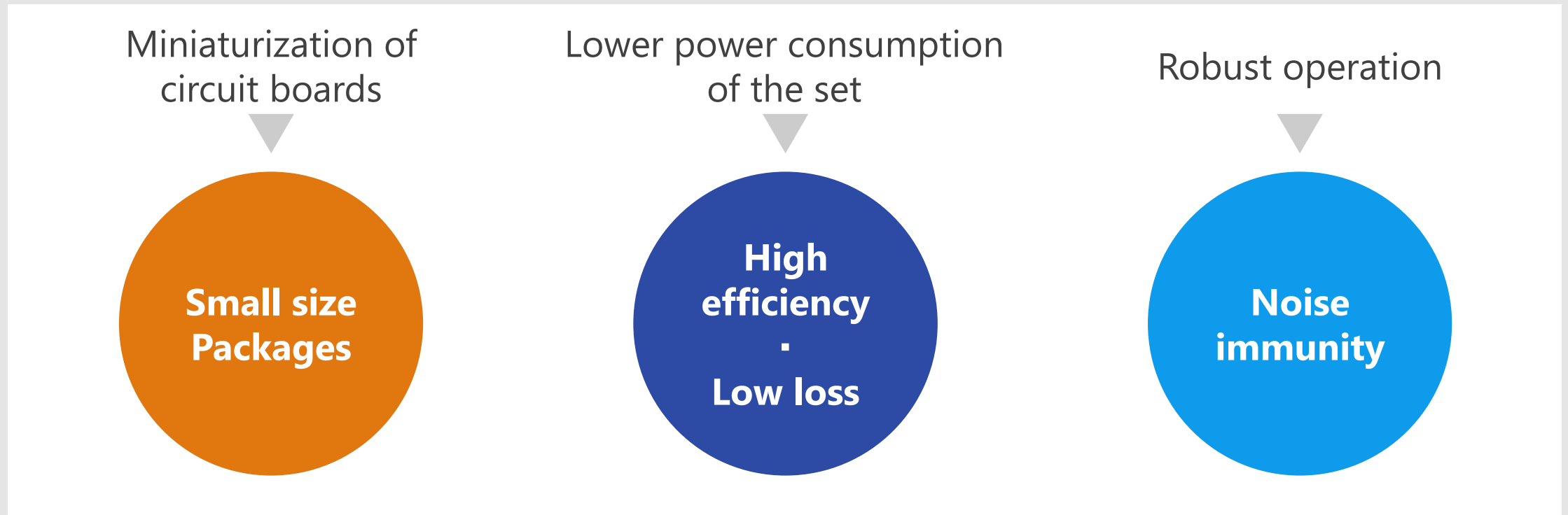

Device solutions to address customer needs

Small size Packages

High efficiency
·
Low loss

Noise immunity

	Small size Packages	High efficiency · Low loss	Noise immunity
① π-MOS Series MOSFET	●	●	
② Transistor output photocoupler	●	●	●
③ Bipolar transistor	●	●	
④ Schottky barrier diode	●	●	●
⑤ Fast recovery diode	●	●	
⑥ Small signal MOSFET	●	●	
⑦ TVS diode	●		●
⑧ MCU <small>TMPM061FWFG</small>	●	●	
⑨ Stepping motor driver with a built-in AGC	●	●	
⑩a ⑩b Stepping motor driver	●	●	
⑪a ⑪b Brushed DC motor driver	●	●	

Value provided

This MOSFET is suitable for switching regulators and is easy to handle and contributes to miniaturization.

1 Low on-resistance

By keeping the on-resistance between the drain and source low, heat generation and power consumption can be kept low.

2 Low leakage current

Drain cut-off current $I_{DSS} = 10 \mu\text{A}$ (Max)
($V_{DS} = 600 \text{ V}$)

3 Enhancement type

It is easy to handle because it is an enhancement type in which no collector current flows when no gate voltage is applied.

TK2K2A60F Characteristics Curves

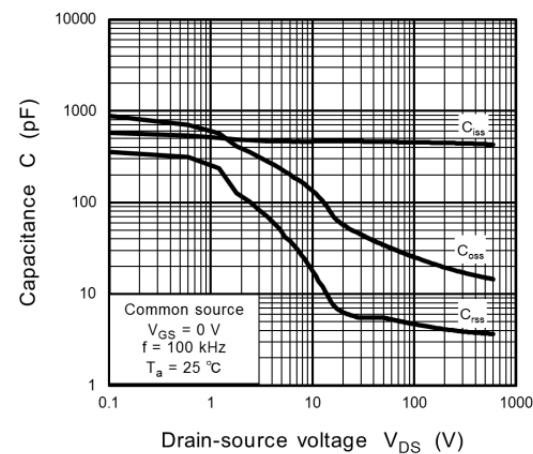
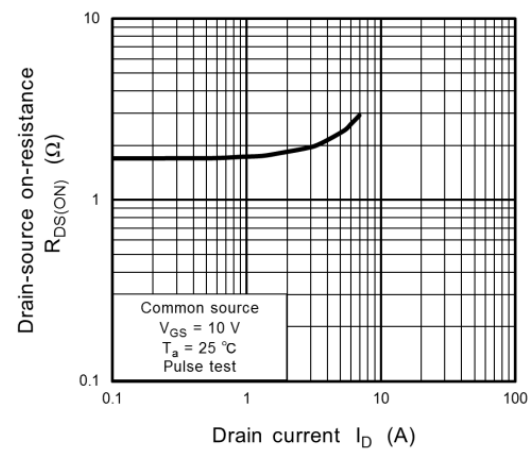

Lineup

Part number	TK2K2A60F	
Package	TO-220SIS	
V_{DSS} [V]	600	
I_D [A]	3.5	
C_{iss} (Typ.) [pF]	450	
$R_{DS(ON)}$ [Ω]	Typ.	1.82
	Max	2.2
Polarity	N-ch	

[Return to Block Diagram TOP](#)

2 Transistor output photocoupler

TLP383 / TLP385 / TLP387 / TLP388

Small size Packages

High efficiency
Low loss

Noise immunity

Value provided

Reduction in required circuit board area and improving reliability enabling maintenance-free operation.

1 High isolation voltage is realized even using compact and thin package

It is a highly isolated photocoupler that phototransistors and infrared light emitting diodes are optically coupled, and achieved a high isolation voltage of 5000 Vrms. In addition, since the SO6L package is smaller and thinner than Toshiba standard DIP package, high density mounting is possible.

2 Operating temperature is expanded to 110 °C or 125 °C

It is designed to operate even under severe ambient temperature conditions, such as inverters, robots, machinery and high output power supplies.

Industrial equipment

- General purpose inverter
- Servo amplifier
- Robot
- Machine Tool
- High output power supply
- Security equipment
- Semiconductor tester
- PLC (Programmable Logic Controller)
- MFP (Multi Function Printer)

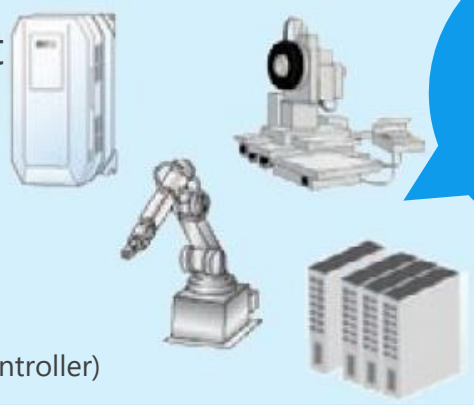

High level of isolation and noise blocking

Lineup

Part number	TLP383	TLP385	TLP387	TLP388
Package	4pin SO6L 			
V _{CEO} [V]	80	80	300	350
BV _S [Vrms]	5000	5000	5000	5000
T _{opr} [°C]	-55 to 125	-55 to 110	-55 to 110	-55 to 125

[Return to Block Diagram TOP](#)

Value provided

It is suitable for low frequency and low noise applications and covers a wide range of applications.

1 High voltage

High voltage allows for large loads and instantaneous voltage changes.

2 Large current (rated collector current)

It covers a wide range of applications, from low frequency applications to power supply applications.

TMBT3904
Characteristics chart

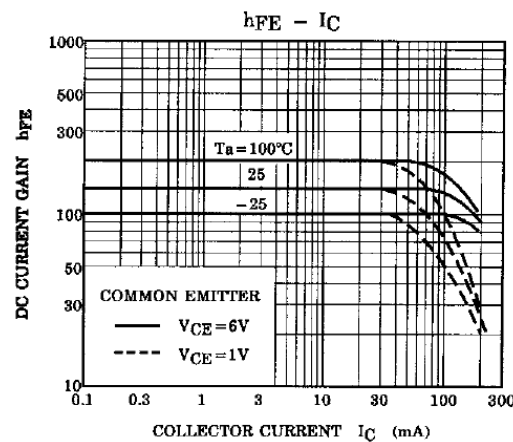
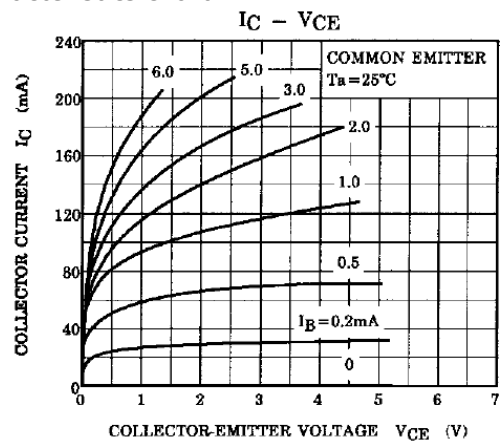

Lineup

Part number	TMBT3904
Package	SOT23 
V _{CEO} [V]	50
I _C [mA]	200
V _{CE(sat)} (Max) [V]	0.3 @ I _C = 50 mA, I _B = 5 mA
h _{FE}	100 to 300 @ V _{CE} = 1 V, I _C = 10 mA
Polarity	NPN

[Return to Block Diagram TOP](#)

4 Schottky barrier diode

CMS15 / CUHS20F60

Small size
Packages

High
efficiency
·
Low loss

Noise
immunity

Value provided

It is suitable for high frequency rectification of switching power supplies and contributes to miniaturization.

1 High speed switching

It is suitable for high speed switching applications.



2 Small package

This small package is suitable for high density mounting.

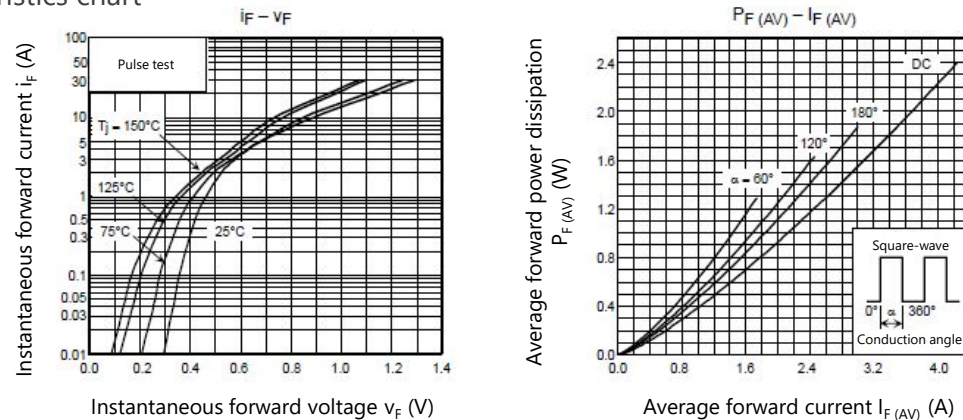
CMS15
Characteristics chart



Lineup

Part number	CMS15	CUHS20F60
Package	 M-FLAT™	 US2H
V_{RRM} / V_R [V]	60	60
$I_{F(AV)} / I_O$ [A]	3.0	2.0
V_{FM} / V_F (Max) [V]	0.58 @ $I_{FM} = 3.0$ A	0.59 @ $I_F = 2.0$ A
C_j (Typ.) [pF]	102	300

[Return to Block Diagram TOP](#)

5 Fast recovery diode

CRF03A

Small size
Packages

High
efficiency
·
Low loss

Noise
immunity

Value provided

This is a silicon diffusion matching type high frequency rectifier diode. Contributes to high efficiency and miniaturization of power supplies.

1 High reverse voltage

Repetitive peak reverse voltage (V_{RRM}) is high.
(CRF03A: Rated 600 V)

2 Fast reverse recovery time

The reverse recovery time (t_{rr}) is fast and is suitable for high speed operation.
(CRF03A: Up to 100 ns)

3 Small package

This small package is suitable for high density mounting.

CRF03A
Characteristics chart

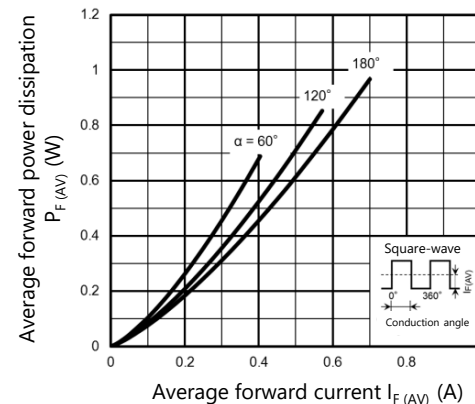
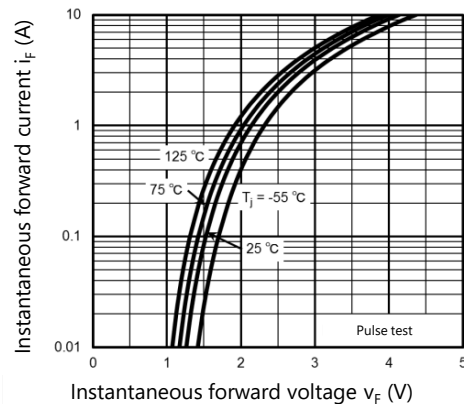

Lineup

Part number	CRF03A
Package	S-FLAT™ 
V_{RRM} [V]	600
$I_{F(AV)}$ [A]	0.7
V_{FM} (Max) [V]	2.0 @ $I_{FM} = 0.7$ A
I_{RRM} (Max) [μ A]	50

[Return to Block Diagram TOP](#)

Value provided

It is suitable for high speed switches and contributes to miniaturization.

1 Low voltage operation

Operate down to $|V_{GS}| = 1.2\text{ V}$.

2 Low on-resistance

By keeping the on-resistance between the drain and source low, heat generation and power consumption can be kept low.

3 Wide package lineup

In addition to SSM packages, we have CST3C packages, VESM packages, ES6 packages and US6 packages.

SSM3K35FS
Internal connection diagram

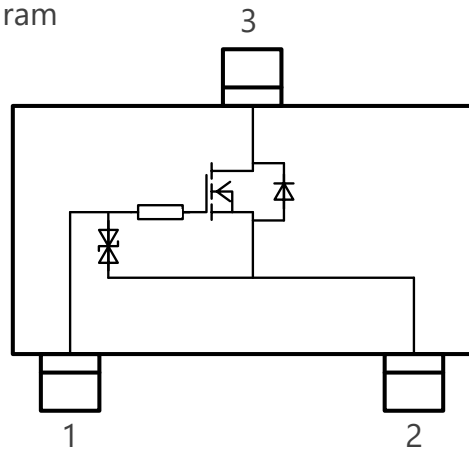

Lineup					
Part number	SSM3K35FS	SSM3K35AFS	SSM3J35FS	SSM3J35AFS	
Package	SSM	SSM	SSM	SSM	
V_{DSS} [V]	20	20	-20	-20	
I_D [A]	0.18	0.25	-0.1	-0.25	
$R_{DS(ON)}$ [Ω] @ $ V_{GS} = 2.5\text{ V}$	Typ.	2	1.1	5.6	1.5
	Max	4	1.6	11	2.1
Polarity	N-ch	N-ch	P-ch	P-ch	

[Return to Block Diagram TOP](#)

Value provided

This absorbs static electricity from external terminals, prevents circuit malfunction and protects devices.

1 Improved ESD pulse absorption

We have improved the absorbency of ESD compared to Toshiba conventional products (50 % reduction in operating resistance). It achieves both low operating resistance and low capacitance, and ensures high signal protection performance and signal quality.

2 Suppress ESD energy by low clamp voltage

TVS diodes protect connected circuits and devices by adopting proprietary technology.

3 Suitable for high density mounting

Small size package is suitable for high density mounting.

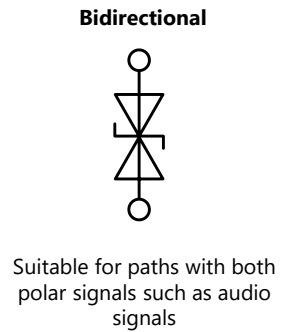
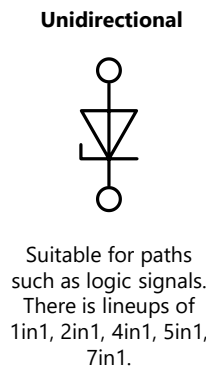
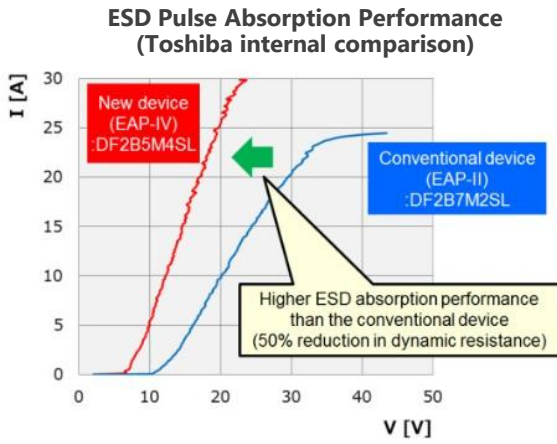

Lineup					
Part number	DF2B5M4ASL	DF2B6M4ASL	DF2B6USL	DF6D6UFE	DF2B6M4BSL
Package	SL2	SL2	SL2	ES6	SL2
V_{ESD} [kV]	±16	±15	±10	±10	±8
V_{RWM} (Max) [V]	3.6	5.5	5.5	5.5	5.5
C_t (Typ.) [pF]	0.15	0.15	1.5	1.5	0.12
R_{DYN} (Typ.) [Ω]	0.7	0.7	0.25	0.25	1.05

(NOTE) This product is an ESD protection diode and cannot be used for purposes other than ESD protection.

[Return to Block Diagram TOP](#)

Value provided

System cost down, high efficiency system, development efficiency improvement

1 Built-in Arm® Cortex®-M0 CPU core

Built-in Arm Cortex-M0 core with Thumb® instruction set improves energy efficiency. Various development tool and their partners allow users many options.

2 Suitable for sensing analog signal

Built-in multichannel AD converter and CPU system executes sensing data processing efficiently at low cost.

3 Small package and low power consumption

Cortex-M0 and original NANOFFLASH™ technology bring to the small package and low power consumption. They contribute to reduction of board area and power consumption.

TMPM061FWFG

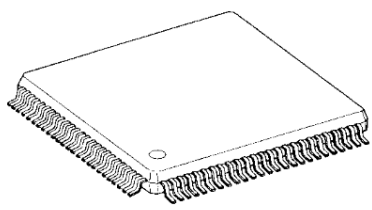

Package: LQFP100-P-1414-0.50G

Lineup

Part number	TMPM061FWFG
Maximum operation frequency	16 MHz
Instruction ROM	128 KB
RAM	8 KB
Timer	9ch
UART/SIO	4ch
AD converter	2ch (10bit), 3ch (24bit)
LCDD	40 seg x 4 com

[Return to Block Diagram TOP](#)

Value provided

Motor current is optimized in real time by using built-in AGC (Active Gain Control).

1 High voltage (50 V)

The maximum rated voltage of these products is 50 V, it can be used in a supply of 12 to 36 V with sufficient margin.

2 Step-out prevention and high efficiency control using AGC

By detecting the motor load torque with just the driver IC and automatically optimizing the current according to the drive condition, step-out avoidance and highly efficient motor control are possible.

3 ADMD (Advanced Dynamic Mixed Decay) realizes high-efficiency operation at high rpm.

Toshiba's original ADMD technology tracks input current more closely than the conventional mixed decay mode ^[Note 1], making highly efficient motor control possible at high rpm.

[Note 1] Comparison with our products

Active Gain Control

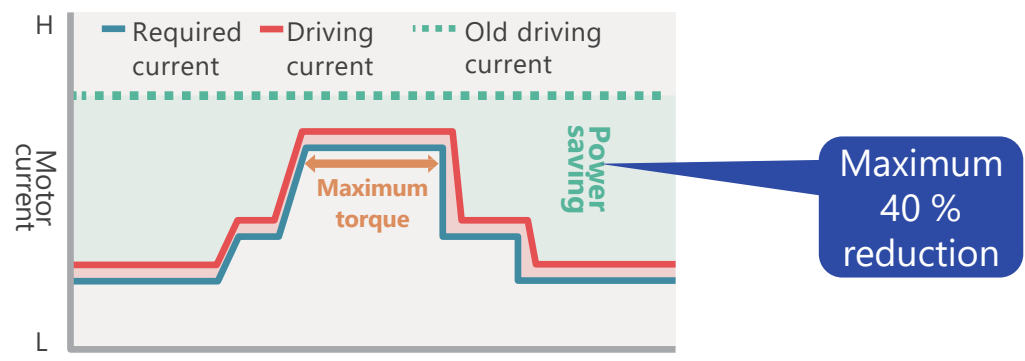

[Note 2] Toshiba internal comparison

Lineup			
Part number		TB67S128FTG	TB67S289FTG
Absolute maximum ratings	Output voltage [V]	50	
	Output current [A]	5.0	3.0
Output ON-resistance (H+L) (Typ.) [Ω]		0.25	0.4
Control interface		Clock / Serial	Clock
Step		1/1, 1/2, 1/4, 1/8, 1/16, 1/32, 1/64, 1/128	1/1, 1/2, 1/4, 1/8, 1/16, 1/32
Features		ADMD (high efficiency control)	ACDS (without current sense resistor)
Error detection function		Thermal shutdown (TSD), over current detection (ISD), power-on-reset (POR), motor load open (OPD)	
Package		P-VQFN64-0909-0.50-006	P-VQFN48-0707-0.50-004

[Return to Block Diagram TOP](#)

Value provided

The maximum voltage rating of 40 V. Standard stepping motor drivers with a small package

1 High voltage and current

The maximum rated voltage of these products is 40 V, and the maximum rated current is 2 or 2.8 A. Low on-resistance contributes low power consumption and low heat.

2 Small size and high heat dissipation

The package uses a high heat dissipation QFN with an E-Pad on the bottom. Heat is dissipated by connecting the E-Pad part to the board GND. It also contributes to the reduction of board area.

3 Error detection functions

Over current detection (ISD), thermal shutdown (TSD) and power on reset (POR) are available for safe motor driving.

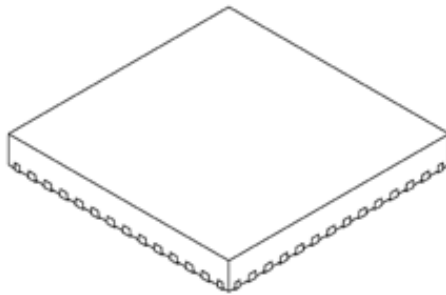

Package: P-WQFN36-0606-0.50-002
(6 x 6 mm)

Lineup

Part number		TB67S511FTAG	TB67S512FTAG	TB67S521FTAG	TB67S522FTAG
Absolute maximum ratings	Output voltage [V]	40			
	Output current [A]	2.0		2.8	
Output ON-resistance (H+L) (Typ.) [Ω]		0.8		0.53	
Driving type		PWM constant current drive			
Excitation mode		full, half and quarter step resolutions			
Control interface		Phase	Clock	Phase	Clock
Error detection function		Thermal shut down (TSD), over current (ISD), power on reset (POR)			
Package		P-WQFN36-0606-0.50-002			

[◆Return to Block Diagram TOP](#)

Value provided

The maximum voltage rating of 40 V. Standard stepping motor drivers with a small package

1 High voltage and current

The maximum rated voltage of these products is 40 V, and the maximum rated current is 2 or 1.5 A. Low on-resistance contributes low power consumption and low heat.

2 Small size and high heat dissipation

The package uses a high heat dissipation QFN with an E-Pad on the bottom. Heat is dissipated by connecting the E-Pad part to the board GND. It also contributes to the reduction of board area.

3 Error detection functions

Over current detection (ISD), thermal shut down (TSD) and under voltage lockout (UVLO) are available for safe motor driving.

TB67S539FTG

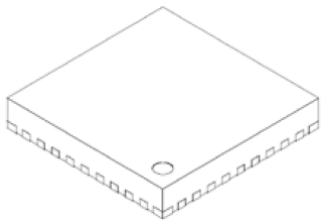

Package: P-VQFN32-0505-0.50-004
(5 x 5 mm)

TB67S549FTG

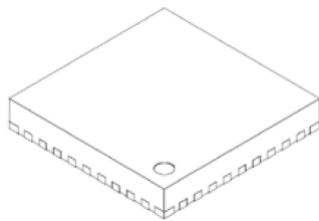

Package: P-VQFN24-0404-0.50-004
(4 x 4 mm)

Lineup

Part number		TB67S539FTG	TB67S549FTG
Absolute maximum ratings	Output voltage [V]	40	40
	Output current [A]	2.0	1.5
Output ON-resistance (H+L) (Typ.) [Ω]		0.8	1.2
Driving type		PWM constant current drive	
Excitation mode		full, half, quarter, 1/8, 1/16 and 1/32 step resolutions	
Control interface		Clock	
Error detection function		Thermal shut down (TSD), over current (ISD), low voltage (UVLO)	
Package		P-VQFN32-0505-0.50-004	P-VQFN24-0404-0.50-004

[◆Return to Block Diagram TOP](#)

Value provided

High voltage, high current and low power consumption with BiCD process. Simple single channel version.

1 High voltage (50 V)/ High current

Maximum rating of the output voltage is improved from 40 to 50 V to allow margin for air discharge test, etc.

2 Wide operation voltage range

Wide power supply voltage range from 4.5 to 44 V supports battery driven applications.

3 Mature package

Adopting HSOP8 package compatible with competitor's products or Toshiba conventional products.

Simple solution

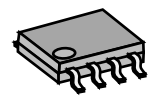
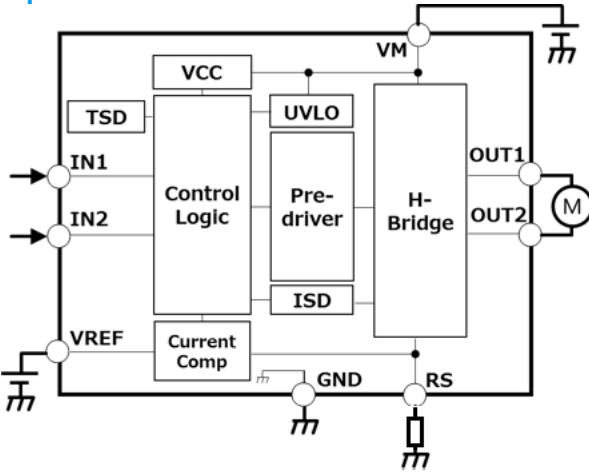

P-HSOP8-0405-1.27-002
(4.9 x 6.0 mm)

Lineup		
Part number	TB67H450AFNG	TB67H451AFNG
Motor type	Brushed DC motor	
Absolute maximum ratings	Output voltage [V]	50
	Output current [A]	3.5
Output ON-resistance (H+L) (Typ.) [Ω]	0.6	
Output circuit	1ch	
Error detection function	Thermal shut down (TSD), over current (ISD), low voltage (UVLO)	
Package	P-HSOP8-0405-1.27-002	

[Return to Block Diagram TOP](#)

Value provided

High voltage, high current with BiCD process. More selection supports higher current driving.

1 High voltage (50 V)/ High current

Maximum rating of the output voltage is improved from 40 to 50 V to allow margin for air discharge test, etc.

2 Wide operation voltage range

Wide operation voltage range from 10 to 47 V supports battery driven applications.

3 High current drive

Built-in 2ch of H-bridge circuit can drive two brushed DC motors or a single brushed motor by using large mode which obtains two times current.

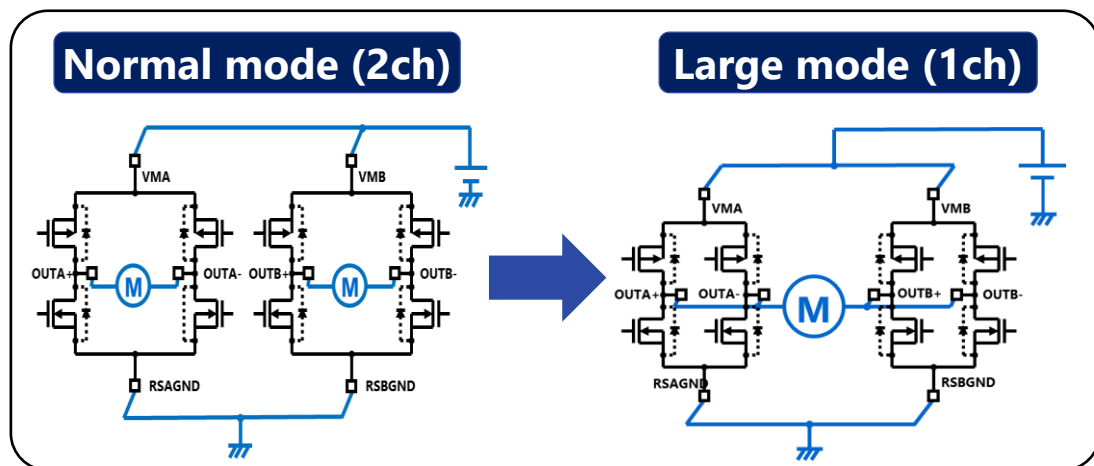

Lineup

Part number		TB67H400AFTG	TB67H410FTG	TB67H420FTG
Motor type		Brushed DC motor		
Absolute maximum ratings	Output voltage [V]	50		
	Output current (Normal) [A]	4.0	2.5	4.5
	Output current (Large) [A]	8.0	5.0	9.0
Output ON-resistance (Normal) (H+L) [Ω]		0.49	0.8	0.33
Error detection function		TSD, ISD, POR*		TSD, ISD, POR, OPD*
Package		P-WQFN48-0707-0.50-003		P-VQFN48-0707-0.50-004

* Thermal shutdown (TSD), over current detection (ISD), power-on-reset (POR), motor load open (OPD)

[Return to Block Diagram TOP](#)

If you are interested in these products and have questions or comments about any of them, please do not hesitate to contact us below:

Contact address: <https://toshiba.semicon-storage.com/ap-en/contact.html>



Terms of use

This terms of use is made between Toshiba Electronic Devices and Storage Corporation (“We”) and Customer who downloads or uses this Reference Design. Customer shall comply with this terms of use. This Reference Design means all documents and data in order to design electronics applications on which our semiconductor device is embedded.

Section 1. Restrictions on usage

1. This Reference Design is provided solely as reference data for designing electronics applications. Customer shall not use this Reference Design for any other purpose, including without limitation, verification of reliability.
2. Customer shall not use this Reference Design for sale, lease or other transfer.
3. Customer shall not use this Reference Design for evaluation in high or low temperature, high humidity, or high electromagnetic environments.
4. This Reference Design shall not be used for or incorporated into any product or system whose manufacture, use, or sale is prohibited under any applicable laws or regulations.

Section 2. Limitations

1. We reserve the right to make changes to this Reference Design without notice.
2. This Reference Design should be treated as a reference only. WE ARE NOT RESPONSIBLE FOR ANY INCORRECT OR INCOMPLETE DATA AND INFORMATION.
3. Semiconductor devices can malfunction or fail. When designing electronics applications by referring to this Reference Design, Customer is responsible for complying with safety standards and for providing adequate designs and safeguards for their hardware, software and systems which minimize risk and avoid situations in which a malfunction or failure of semiconductor devices could cause loss of human life, bodily injury or damage to property, including data loss or corruption. Customer must also refer to and comply with the latest versions of all relevant our information, including without limitation, specifications, data sheets and application notes for semiconductor devices, as well as the precautions and conditions set forth in the "Semiconductor Reliability Handbook".
4. Designing electronics applications by referring to this Reference Design, Customer must evaluate the whole system sufficiently. Customer is solely responsible for applying this Reference Design to Customer's own product design or applications. WE ASSUME NO LIABILITY FOR CUSTOMER'S PRODUCT DESIGN OR APPLICATIONS.
5. WE SHALL NOT BE RESPONSIBLE FOR ANY INFRINGEMENT OF PATENTS OR ANY OTHER INTELLECTUAL PROPERTY RIGHTS OF THIRD PARTIES THAT MAY RESULT FROM THE USE OF THIS REFERENCE DESIGN. NO LICENSE TO ANY INTELLECTUAL PROPERTY RIGHT IS GRANTED BY THIS TERMS OF USE, WHETHER EXPRESS OR IMPLIED, BY ESTOPPEL OR OTHERWISE.
6. THIS REFERENCE DESIGN IS PROVIDED "AS IS". WE (a) ASSUME NO LIABILITY WHATSOEVER, INCLUDING WITHOUT LIMITATION, INDIRECT, CONSEQUENTIAL, SPECIAL, OR INCIDENTAL DAMAGES OR LOSS, INCLUDING WITHOUT LIMITATION, LOSS OF PROFITS, LOSS OF OPPORTUNITIES, BUSINESS INTERRUPTION AND LOSS OF DATA, AND (b) DISCLAIM ANY AND ALL EXPRESS OR IMPLIED WARRANTIES AND CONDITIONS RELATED TO THIS REFERENCE DESIGN, INCLUDING WITHOUT LIMITATION, WARRANTIES OR CONDITIONS OF FUNCTION AND WORKING, WARRANTIES OF MERCHANTABILITY, FITNESS FOR A PARTICULAR PURPOSE, ACCURACY OF INFORMATION, OR NONINFRINGEMENT.

Section 3. Terms and Termination

It is assumed that Customer agrees to any and all this terms of use if Customer downloads or uses this Reference Design. We may, at its sole and exclusive discretion, change, alter, modify, add, and/or remove any part of this terms of use at any time without any prior notice. We may terminate this terms of use at any time and without any cause. Upon termination of this terms of use, Customer shall eliminate this Reference Design. Furthermore, upon our request, Customer shall submit to us a written confirmation to prove elimination of this Reference Design.

Section 4. Export Control

Customer shall not use or otherwise make available this Reference Design for any military purposes, including without limitation, for the design, development, use, stockpiling or manufacturing of nuclear, chemical, or biological weapons or missile technology products (mass destruction weapons). This Reference Design may be controlled under the applicable export laws and regulations including, without limitation, the Japanese Foreign Exchange and Foreign Trade Act and the U.S. Export Administration Regulations. Export and re-export of this Reference Design is strictly prohibited except in compliance with all applicable export laws and regulations.

Section 5. Governing Laws

This terms of use shall be governed and construed by laws of Japan, without reference to conflict of law principle.

Section 6. Jurisdiction

Unless otherwise specified, Tokyo District Court in Tokyo, Japan shall be exclusively the court of first jurisdiction for all disputes under this terms of use.

RESTRICTIONS ON PRODUCT USE

- Toshiba Electronic Devices & Storage Corporation, and its subsidiaries and affiliates (collectively "TOSHIBA"), reserve the right to make changes to the information in this document, and related hardware, software and systems (collectively "Product") without notice.
- This document and any information herein may not be reproduced without prior written permission from TOSHIBA. Even with TOSHIBA's written permission, reproduction is permissible only if reproduction is without alteration/omission.
- Though TOSHIBA works continually to improve Product's quality and reliability, Product can malfunction or fail. Customers are responsible for complying with safety standards and for providing adequate designs and safeguards for their hardware, software and systems which minimize risk and avoid situations in which a malfunction or failure of Product could cause loss of human life, bodily injury or damage to property, including data loss or corruption. Before customers use the Product, create designs including the Product, or incorporate the Product into their own applications, customers must also refer to and comply with (a) the latest versions of all relevant TOSHIBA information, including without limitation, this document, the specifications, the data sheets and application notes for Product and the precautions and conditions set forth in the "TOSHIBA Semiconductor Reliability Handbook" and (b) the instructions for the application with which the Product will be used with or for. Customers are solely responsible for all aspects of their own product design or applications, including but not limited to (a) determining the appropriateness of the use of this Product in such design or applications; (b) evaluating and determining the applicability of any information contained in this document, or in charts, diagrams, programs, algorithms, sample application circuits, or any other referenced documents; and (c) validating all operating parameters for such designs and applications. **TOSHIBA ASSUMES NO LIABILITY FOR CUSTOMERS' PRODUCT DESIGN OR APPLICATIONS.**
- **PRODUCT IS NEITHER INTENDED NOR WARRANTED FOR USE IN EQUIPMENTS OR SYSTEMS THAT REQUIRE EXTRAORDINARILY HIGH LEVELS OF QUALITY AND/OR RELIABILITY, AND/OR A MALFUNCTION OR FAILURE OF WHICH MAY CAUSE LOSS OF HUMAN LIFE, BODILY INJURY, SERIOUS PROPERTY DAMAGE AND/OR SERIOUS PUBLIC IMPACT ("UNINTENDED USE").** Except for specific applications as expressly stated in this document, Unintended Use includes, without limitation, equipment used in nuclear facilities, equipment used in the aerospace industry, lifesaving and/or life supporting medical equipment, equipment used for automobiles, trains, ships and other transportation, traffic signaling equipment, equipment used to control combustions or explosions, safety devices, elevators and escalators, and devices related to power plant. **IF YOU USE PRODUCT FOR UNINTENDED USE, TOSHIBA ASSUMES NO LIABILITY FOR PRODUCT.** For details, please contact your TOSHIBA sales representative or contact us via our website.
- Do not disassemble, analyze, reverse-engineer, alter, modify, translate or copy Product, whether in whole or in part.
- Product shall not be used for or incorporated into any products or systems whose manufacture, use, or sale is prohibited under any applicable laws or regulations.
- The information contained herein is presented only as guidance for Product use. No responsibility is assumed by TOSHIBA for any infringement of patents or any other intellectual property rights of third parties that may result from the use of Product. No license to any intellectual property right is granted by this document, whether express or implied, by estoppel or otherwise.
- **ABSENT A WRITTEN SIGNED AGREEMENT, EXCEPT AS PROVIDED IN THE RELEVANT TERMS AND CONDITIONS OF SALE FOR PRODUCT, AND TO THE MAXIMUM EXTENT ALLOWABLE BY LAW, TOSHIBA (1) ASSUMES NO LIABILITY WHATSOEVER, INCLUDING WITHOUT LIMITATION, INDIRECT, CONSEQUENTIAL, SPECIAL, OR INCIDENTAL DAMAGES OR LOSS, INCLUDING WITHOUT LIMITATION, LOSS OF PROFITS, LOSS OF OPPORTUNITIES, BUSINESS INTERRUPTION AND LOSS OF DATA, AND (2) DISCLAIMS ANY AND ALL EXPRESS OR IMPLIED WARRANTIES AND CONDITIONS RELATED TO SALE, USE OF PRODUCT, OR INFORMATION, INCLUDING WARRANTIES OR CONDITIONS OF MERCHANTABILITY, FITNESS FOR A PARTICULAR PURPOSE, ACCURACY OF INFORMATION, OR NONINFRINGEMENT.**
- Product may include products using GaAs (Gallium Arsenide). GaAs is harmful to humans if consumed or absorbed, whether in the form of dust or vapor. Handle with care and do not break, cut, crush, grind, dissolve chemically or otherwise expose GaAs in Product.
- Do not use or otherwise make available Product or related software or technology for any military purposes, including without limitation, for the design, development, use, stockpiling or manufacturing of nuclear, chemical, or biological weapons or missile technology products (mass destruction weapons). Product and related software and technology may be controlled under the applicable export laws and regulations including, without limitation, the Japanese Foreign Exchange and Foreign Trade Law and the U.S. Export Administration Regulations. Export and re-export of Product or related software or technology are strictly prohibited except in compliance with all applicable export laws and regulations.
- Please contact your TOSHIBA sales representative for details as to environmental matters such as the RoHS compatibility of Product. Please use Product in compliance with all applicable laws and regulations that regulate the inclusion or use of controlled substances, including without limitation, the EU RoHS Directive. **TOSHIBA ASSUMES NO LIABILITY FOR DAMAGES OR LOSSES OCCURRING AS A RESULT OF NONCOMPLIANCE WITH APPLICABLE LAWS AND REGULATIONS.**

TOSHIBA

* Wi-Fi is a registered trademark of Wi-Fi Alliance.

* Bluetooth® word mark is a registered trademark owned by the Bluetooth SIG, Inc.

* Arm, Cortex and Thumb are registered trademarks of Arm Limited (or its subsidiaries) in the US and/or elsewhere.

* M-FLAT™, S-FLAT™ and NANOFLASH™ are trademarks of Toshiba Electronic Devices & Storage Corporation.

* All other company names, product names, and service names may be trademarks of their respective companies.