

## Introduction of Toshiba diode lineup for Industries

Over the years, Toshiba has expanded its lineup by incorporating various diodes into various packages. This document introduces the diode product lineup to support a wide range of industrial equipment.

### Toshiba is Diode's leading company

Since Toshiba began mass production of diodes in 1956, Toshiba has been one of the diode vendors that have continued to bring their products to the market as a pioneer of the industry since the early days of the semiconductor industry. Our typical switching diode M8555, developed in 1966, has contributed to the times as a compact, high-performance, low-cost diode. Based on our experience in delivering products to many customers, we will continue to offer a wide variety of highly reliable diode products.

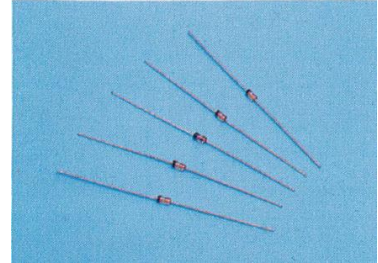

■ Representative old products developed in 1966  
Switching diode M8555

### Stable, high-quality production system at plants in Japan and Thailand

Our current diode products produce a wide range of packages, from small surface mount types, mainly in our own factories, to through-hole types.

### Overview of Toshiba Diode

A diode is a two-terminal semiconductor-device with one PN junction or an alternative junction. Toshiba supplies a wide range of products using its proprietary device technology.

This is Top page for Toshiba Diodes.

#### PN-junction diode

We have a wide range of products, including rectifier diodes and switching diodes, depending on their structure and application.

#### Metal-semiconductor junction diode

Diodes that utilize Schottky barriers generated by the junction between metal and semiconductor. As compared to PN junction diodes

It has the advantage that the forward voltage ( $V_F$ ) is low and the switching performance is fast. The power supply circuit can be made more efficient or smaller.

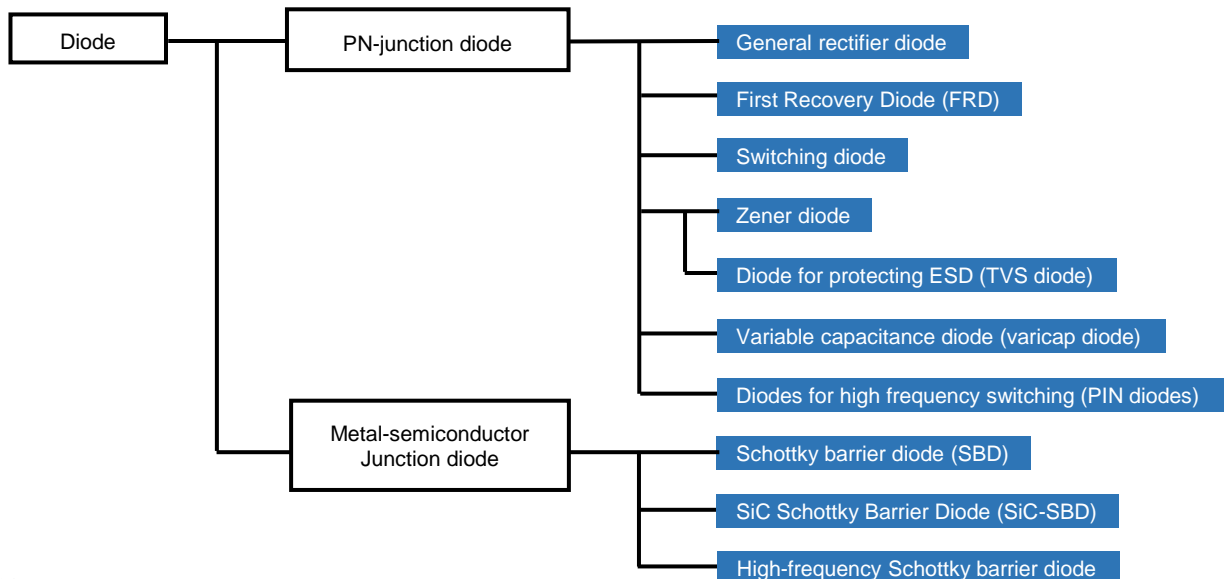

## Toshiba Diode Package Development

Compact and general-purpose USC(2.5 x 1.25 mm), medium-sized and relatively powerable M-FLAT(4.7 x 2.4 mm), and even smaller packages are available for a wide range of applications. In recent years, we have developed US2H packages with heatsinks to achieve compactness and power application. In addition to the power package DFN 8x8(8.0 x 8.0 of SiC devices, we also offer lead-type packages.

### ■ Representative 2Pin surface-mount packaging

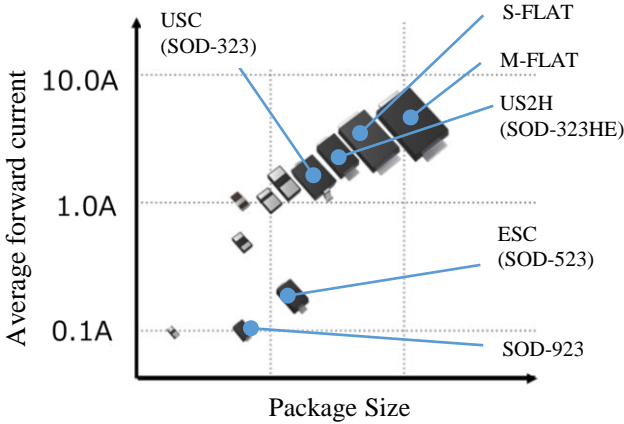

Package Name	Size (mm)	Height (mm)
SOD-923	1.0 × 0.6	0.4
ESC	1.6 × 0.8	0.6
USC	2.5 × 1.25	0.9
US2H	2.5 × 1.4	0.6
S-FLAT	3.5 × 1.6	0.98
M-FLAT	4.7 × 2.4	0.98

### ■ Example Power Package Equipped with SiC SBD

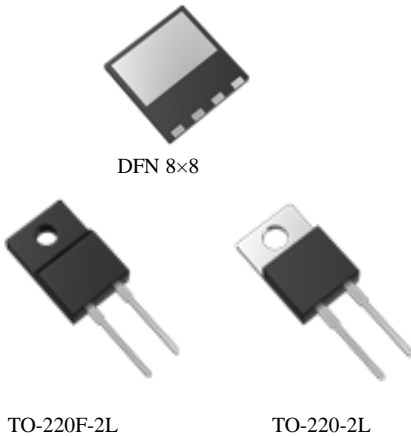

Package Name	Size (mm)	Height (mm)
DFN 8 × 8	8.0 × 8.0	0.85
TO-220F-2L	10.0 × 15.0	4.5
TO-220-2L	10.05 × 15.3	4.45

For other packages, see here.

### Related LINK

- [This is the diode product page.](#)
- [This is the parametric search for the product.](#)
- [Related Application Notes](#)
- [Frequently Asked Questions for Diodes \(FAQ\)](#)
- [Cross reference search is shown here.](#)

Click

Click

Click

Click

Click

## General rectifier diode

### <Product Overview>

Rectifier diodes have been widely used to convert alternating current to direct current. Recently, they are mainly used to prevent backflow and reverse connection.

Our lineup of products has 400V, 600V and high-withstand voltage, so they are used for power supply lines that apply various voltages. Averaged forward currents are available from 0.4A to 2.0A and are available in surface-mount packaging suitable for high-density mounting.

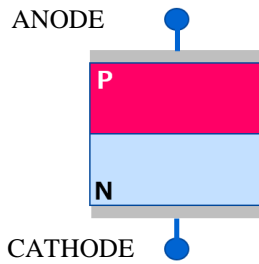

### <Structural drawing>

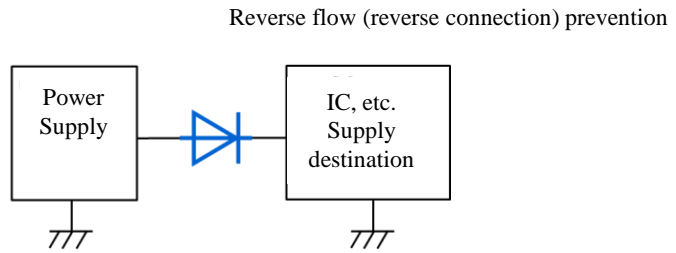

### <Circuit example>



## Our general rectifier diode selection table

$V_{RRM}$ (V)	$I_F$ (A)	$I_{FSM}$ (A)	$T_j$ (°C)	Product name	Product type	$V_{FM}$ Typ (V)	$@I_{FM}$	$I_{RRM}$ Max ( $\mu$ A)	Package (Common Name)	Dimensions (mm)	Purchase
							(A)				
400	0.4	8	150	<a href="#">CRG11B</a>	General rectifier diode	1.1	0.4	5	S-FLAT	 1.6 × 3.5 × 0.98	<a href="#">Buy Online</a>
	1.0	15	150	<a href="#">CRG09A</a>	General rectifier diode	1.1	0.7	5	S-FLAT		<a href="#">Buy Online</a>
	1.0	10	150	<a href="#">CRG09B</a>	General rectifier diode	1.1	0.7	5	S-FLAT		<a href="#">Buy Online</a>
600	0.7	15	150	<a href="#">CRG10A</a>	General rectifier diode	1.1	0.7	5	S-FLAT		<a href="#">Buy Online</a>
	1.0	20	150	<a href="#">CRG04A</a>	General rectifier diode	1.1	1.0	5	S-FLAT	<a href="#">Buy Online</a>	
	1.0	20	150	<a href="#">CMG06A</a>	General rectifier diode	1.1	1.0	5	M-FLAT	 2.4 × 4.7 × 0.98	<a href="#">Buy Online</a>
	2.0	80	150	<a href="#">CMG03A</a>	General rectifier diode	1.1	2.0	5	M-FLAT		<a href="#">Buy Online</a>

## Ultrahigh-speed Rectifier (FRD)

### <Product Overview>

First recovery diodes are a type of rectifier diodes. They have a quicker reverse-recovery-time  $t_{rr}$  than conventional rectifier diodes and are suitable for high-speed rectification. Therefore, it is used as a protective device for the snubber circuit used in the power supply circuit, as shown in the circuit below, or as a rectifying device required for DCDC converter or ACDC converter circuit. On the other hand, the forward voltage and leakage current tend to increase in comparison with the conventional rectifier diode. Therefore, a heat dissipation design considering forward loss and reverse loss should be adopted.

### <Reverse-recovery-time $t_{rr}$ >

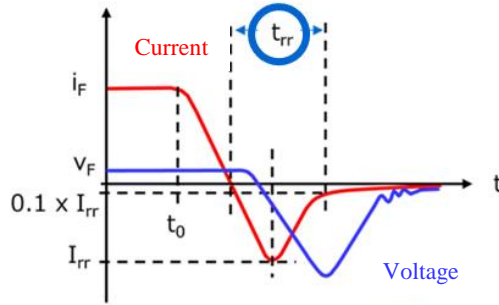

### Trr guideline:

General rectifier diodes:

A few  $\mu$ s to several tens of  $\mu$ s

FRD:

Several ns to hundreds of ns

### <Circuit example>

Switching power supplies  
Snubber circuit

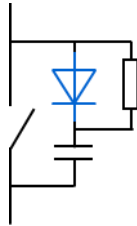

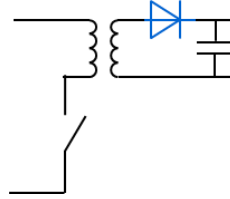

Secondary of DCDC converter



## Our FRD selection table for ultra high-speed rectification

※ 1:IF=1A,di/dt=-30A/ $\mu$ s

$V_{RRM}$ (V)	$I_F$ (A)	$I_{FSM}$ (A)	$T_j$ (°C)	Product name	$V_{FM}$ Max	$I_{RRM}$ Max	Trr Typ. (ns)*1	Package (Common Name)	Dimensions (mm)	Purchase	
					(V)	@ $I_{FM}$ (A)					( $\mu$ A)
200	0.5	10	150	<a href="#">CRH02</a>	0.95	0.5	10	35	S-FLAT		<a href="#">Buy Online</a>
	0.5	10	150	<a href="#">CRH02B</a>	0.95	0.5	5	35		<a href="#">Buy Online</a>	
	1.0	15	150	<a href="#">CRH01</a>	0.98	1.0	10	35		<a href="#">Buy Online</a>	
	1.0	10	150	<a href="#">CRH01B</a>	0.98	1.0	5	35	S-FLAT	1.6 × 3.5 × 0.98	<a href="#">Buy Online</a>
	1.0	20	150	<a href="#">CMH04</a>	0.98	1.0	10	35	M-FLAT		<a href="#">Buy Online</a>
	2.0	40	150	<a href="#">CMH07</a>	0.98	2.0	10	35			<a href="#">Buy Online</a>
	3.0	40	150	<a href="#">CMH01</a>	0.98	3.0	10	35			<a href="#">Buy Online</a>
600	0.7	10	150	<a href="#">CRF03A</a>	2.0	0.7	50	100	S-FLAT	1.6 × 3.5 × 0.98	<a href="#">Buy Online</a>
	1.0	10	150	<a href="#">CMF02A</a>	2.0	1.0	50	100	M-FLAT	2.4 × 4.7 × 0.98	<a href="#">Buy Online</a>
	2.0	30	150	<a href="#">CMF01A</a>	2.0	2.0	50	100	M-FLAT		<a href="#">Buy Online</a>

## Switching diode

<Product Overview>

Diodes that use PN junctions for switching applications. 80mA~500mA rated current is a product lineup that includes one to four circuits in a small package. This product is ideal for high-density electronic equipment.

In addition to signal rectification (switching) applications as in circuit examples, some cases are used for protection applications such as clamp circuits.

A typical 1SS352 is that the reverse-recovery-time  $t_{rr}$  is devised in the same way as the ultra-high-speed rectifier.

<Circuit example>

For signal switching (rectification)

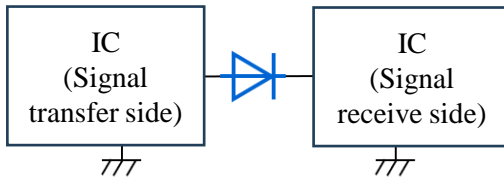

For clamp circuit

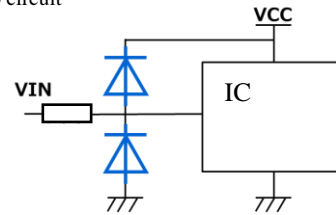

## Our switching diode selection table

Product Number	VR (Max) (V)	IO (Max) (A)	Internal connection	Pin Number	Packaging (Toshiba)	AEC-Q101	Package dimensions (mm)	Purchase
<a href="#">1SS387CT</a>	80	0.1	Single	2	CST2		1.0 x 0.6 x 0.38	<a href="#">Buy Online</a>
<a href="#">1SS307E</a>	80	0.1	Single	2	ESC	Compatible products	1.6 x 0.8 x 0.6	<a href="#">Buy Online</a>
<a href="#">1SS387</a>	80	0.1	Single	2	ESC	Compatible products	1.6 x 0.8 x 0.6	<a href="#">Buy Online</a>
<a href="#">1SS403E</a>	200	0.1	Single	2	ESC		1.6 x 0.8 x 0.6	<a href="#">Buy Online</a>
<a href="#">BAS516</a>	100	0.25	Single	2	ESC		1.6 x 0.8 x 0.6	<a href="#">Buy Online</a>
<a href="#">1N4148WT</a>	100	0.25	Single	2	ESC		1.6 x 0.8 x 0.6	<a href="#">Buy Online</a>
<a href="#">1SS187</a>	80	0.1	Single	3	S-Mini	Compatible products	2.9 x 2.5 x 1.1	<a href="#">Buy Online</a>
<a href="#">1SS190</a>	80	0.1	Single	3	S-Mini		2.9 x 2.5 x 1.1	<a href="#">Buy Online</a>
<a href="#">1SS193</a>	80	0.1	Single	3	S-Mini	Compatible products	2.9 x 2.5 x 1.1	<a href="#">Buy Online</a>
<a href="#">1SS196</a>	80	0.1	Single	3	S-Mini	Compatible products	2.9 x 2.5 x 1.1	<a href="#">Buy Online</a>
<a href="#">1SS250</a>	200	0.1	Single	3	S-Mini		2.9 x 2.5 x 1.1	<a href="#">Buy Online</a>
<a href="#">1SS307</a>	30	0.1	Single	3	S-Mini		2.9 x 2.5 x 1.1	<a href="#">Buy Online</a>
<a href="#">1SS427</a>	80	0.1	Single	2	SOD-923		1.0 x 0.6 x 0.4	<a href="#">Buy Online</a>
<a href="#">TBAS16</a>	80	0.215	Single	3	SOT23		2.9 x 2.4 x 0.9	<a href="#">Buy Online</a>
<a href="#">1SS352</a>	80	0.1	Single	2	USC	Compatible products	2.5 x 1.25 x 0.9	<a href="#">Buy Online</a>
<a href="#">1SS403</a>	200	0.1	Single	2	USC	Compatible products	2.5 x 1.25 x 0.9	<a href="#">Buy Online</a>
<a href="#">BAS316</a>	100	0.25	Single	2	USC		2.5 x 1.25 x 0.9	<a href="#">Buy Online</a>
<a href="#">1N4148WS</a>	100	0.25	Single	2	USC		2.5 x 1.25 x 0.9	<a href="#">Buy Online</a>
<a href="#">1SS370</a>	200	0.1	Single	3	USM		2.0 x 2.1 x 0.9	<a href="#">Buy Online</a>
<a href="#">1SS397</a>	400	0.1	Single	3	USM		2.0 x 2.1 x 0.9	<a href="#">Buy Online</a>

The other lineup is here.

## Zener diode

### <Product Overview>

The reverse-voltage of PN junction is used to clamp the desired voltage and to protect semiconductors, such as IC, from overvoltages applied to the circuitry. In a power line, etc., a surge may be generated with a long pulse width reaching several milliseconds when the circuit is opened or closed. Zener diodes protect semi-conductor devices from overvoltages close to DC that are difficult to protect with ESD protective diodes. Of course, it can protect semi-conductor devices from ESD of less than 100 nanoseconds and from dielectric lightning surges of the order of microseconds, thus contributing to reliability improvement of equipment.

### <Structural drawing>

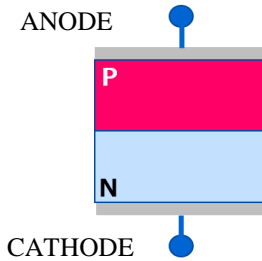

### <Usage example>

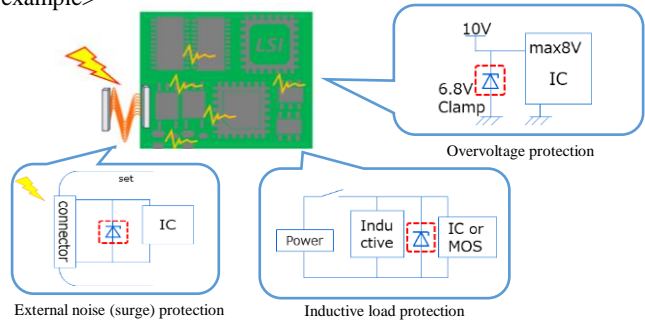

## Our Zener-Diode Selection Table

Allowable Loss (W)	Product name	Zener characteristics				Dimensions (mm) (Common Name)	Purchase
		Vz(V)			@Iz (mA)		
		Min	Typ	Max			
0.7	<a href="#">CRY62</a>	5.6	6.2	6.8	10	 S-FLAT 1.6×3.5×0.98	<a href="#">Buy Online</a>
	<a href="#">CRY68</a>	6.2	6.8	7.4	10		<a href="#">Buy Online</a>
	<a href="#">CRY82</a>	7.4	8.2	9.0	10		<a href="#">Buy Online</a>
	<a href="#">CRZ10</a>	9.0	10.0	11.0	10		<a href="#">Buy Online</a>
	<a href="#">CRZ12</a>	10.8	12.0	13.2	10		<a href="#">Buy Online</a>
	<a href="#">CRZ13</a>	11.7	13.0	14.3	10		<a href="#">Buy Online</a>
	<a href="#">CRZ15</a>	13.5	15.0	16.5	10		<a href="#">Buy Online</a>
	<a href="#">CRZ16</a>	14.4	16.0	17.6	10		<a href="#">Buy Online</a>
	<a href="#">CRZ18</a>	16.2	18.0	19.8	10		<a href="#">Buy Online</a>
	<a href="#">CRZ20</a>	18.0	20.0	22.0	10		<a href="#">Buy Online</a>
	<a href="#">CRZ24</a>	21.6	24.0	26.4	10		<a href="#">Buy Online</a>
	<a href="#">CRZ27</a>	24.3	27.0	29.7	10		<a href="#">Buy Online</a>
	<a href="#">CRZ30</a>	27.0	30.0	33.0	10		<a href="#">Buy Online</a>
	<a href="#">CRZ33</a>	29.7	33.0	36.3	10		<a href="#">Buy Online</a>
	<a href="#">CRZ36</a>	32.4	36.0	39.6	9		<a href="#">Buy Online</a>
<a href="#">CRZ39</a>	35.1	39.0	42.9	8	<a href="#">Buy Online</a>		

Allowable Loss (W)	Product name	Zener characteristics				Dimensions (mm) (Common Name)	Purchase
		Vz(V)			@Iz (mA)		
		Min	Typ	Max			
0.3	<a href="#">CEZ5V6</a>	5.3	5.6	6.0	5	 ESC 1.6×0.8×0.6	<a href="#">Buy Online</a>
	<a href="#">CEZ6V2</a>	5.8	6.2	6.6	5		<a href="#">Buy Online</a>
	<a href="#">CEZ6V8</a>	6.4	6.8	7.2	5		<a href="#">Buy Online</a>
	<a href="#">CEZ7V5</a>	7.0	7.5	7.9	5		<a href="#">Buy Online</a>
	<a href="#">CEZ8V2</a>	7.7	8.2	8.7	5		<a href="#">Buy Online</a>
	<a href="#">CEZ9V1</a>	8.5	9.1	9.6	5		<a href="#">Buy Online</a>
	<a href="#">CEZ10V</a>	9.4	10	10.6	5		<a href="#">Buy Online</a>
	<a href="#">CEZ11V</a>	10.4	11	11.6	5		<a href="#">Buy Online</a>
	<a href="#">CEZ12V</a>	11.4	12	12.6	5		<a href="#">Buy Online</a>
	<a href="#">CEZ13V</a>	12.4	13	14.1	5		<a href="#">Buy Online</a>
	<a href="#">CEZ15V</a>	13.8	15	15.6	5		<a href="#">Buy Online</a>
	<a href="#">CEZ16V</a>	15.3	16	17.1	5		<a href="#">Buy Online</a>
	<a href="#">CEZ18V</a>	16.8	18	19.1	5		<a href="#">Buy Online</a>
	<a href="#">CEZ20V</a>	18.8	20	21.2	5		<a href="#">Buy Online</a>
	<a href="#">CEZ22V</a>	10.8	22	23.3	5		<a href="#">Buy Online</a>
	<a href="#">CEZ24V</a>	22.8	24	25.6	5		<a href="#">Buy Online</a>
	<a href="#">CEZ27V</a>	25.1	27	28.9	2		<a href="#">Buy Online</a>
	<a href="#">CEZ30V</a>	28.0	30	32.0	2		<a href="#">Buy Online</a>
	<a href="#">CEZ33V</a>	31.0	33	35.0	2		<a href="#">Buy Online</a>
	<a href="#">CEZ36V</a>	34.0	36	38.0	2		<a href="#">Buy Online</a>

The other lineup is here.

## Diode for protecting ESD (TVS diode)

### <Product Overview>

ESD protection diodes (TVS diodes) are diodes that protect devices from surge voltages such as static electricity entering from external terminals and prevent IC malfunctions. We contribute to protection of electronic equipment in a wide range of applications, including consumer, industrial, and automotive applications, by developing our own product lineup that focuses on low capacity and protection performance. A typical DF2S5M4FS is a low-capacitance type that uses SOD-923 packaging with excellent mounting visibility.

### <Usage example>

In the event of a voltage surge

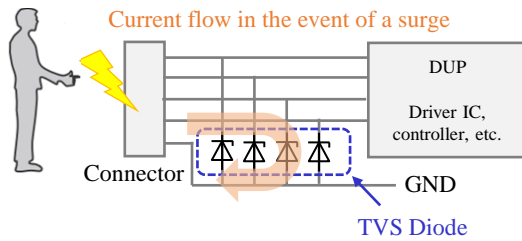

### <Representative Products>

#### DF2S5M4FS



**Features**  
 Compact + Mounting Visibility Package  
 Low capacitance: 0.45pF(typ.)  
 Low dynamic resistor: 0.35 Ω(typ.)  
 AEC-Q101 conformance

## Our diode for protecting ESD (TVS diode) Selection table

Signal line Application	C <sub>t</sub> (typ.)	V <sub>RWM</sub> (MAX)(V)	SL2 (SOD-962) 1.0x0.6mm	CST2 (SOD-882) 1.0x0.6mm	SOD-923 1.0x0.6mm	ESC (SOD-523) 1.6x0.8mm	USC (SOD-323) 2.5x1.25mm
USB 3.2(10Gbps) Thunderbolt™ 3(20Gbps) HDMI® 2.1(16Gbps) Wi-Fi® Bluetooth® (2.4GHz)	0.1~0.15pF	3.6V	<a href="#">DF2B5M4ASL</a>	-	-	-	-
		5.5V	<a href="#">DF2B6M4BSL</a> <a href="#">DF2B6M4ASL</a> <a href="#">DF2B7M3SL</a>	-	-	-	
USB 3.1(10Gbps) HDMI® 2.0(6Gbps)	0.2~0.35pF	3.6V, 3.3V	<a href="#">DF2B5M5SL</a> <a href="#">DF2B5M4SL</a> <a href="#">DF2S5M5SL</a> <a href="#">DF2S5M4SL</a>	<a href="#">DF2B5M4CT</a> <a href="#">DF2B5M5CT</a> <a href="#">DF2S5M4CT</a>	-	-	-
		5.5V, 5V	<a href="#">DF2B6M5SL</a> <a href="#">DF2B6M4SL</a> <a href="#">DF2S6M5SL</a> <a href="#">DF2S6M4SL</a>	<a href="#">DF2B6M4CT</a> <a href="#">DF2B6M5CT</a> <a href="#">DF2S6M4CT</a> <a href="#">DF2B6.8M1ACT</a>	-	-	-
		11V, 18.5V, 24V	<a href="#">DF2B12M4SL</a> <a href="#">DF2B20M4SL</a> <a href="#">DF2B26M4SL</a>	-	-	-	
NFC, Sensor	0.5~0.6pF	3.3V	<a href="#">DF2S5M5SL</a>	<a href="#">DF2S5M5CT</a>	<a href="#">DF2S5M4FS</a>	-	-
		5V	<a href="#">DF2S6M5SL</a>	<a href="#">DF2S6M5CT</a>	<a href="#">DF2S6M4FS</a>	-	-
USB 3.0(5Gbps)	0.9~1.5pF	5.5V, 5V	<a href="#">DF2B6USL</a>	-	-	-	-
USB 2.0(480Mbps)	~45pF	5.5V	<a href="#">DF2B7BSL</a> <a href="#">DF2B7ASL</a>	<a href="#">DF2B7ACT</a> <a href="#">DF2B7PCT</a>	<a href="#">DF2B7AFS</a>	<a href="#">DF2B7AE</a> <a href="#">DF2B6.8E</a>	<a href="#">DF2B7AFU</a>
GPIO, Audio, I2C etc (100MHz~kHz)	~45pF	3.6V, 3.3V	<a href="#">DF2B5BSL</a> <a href="#">DF2B5SL</a>	<a href="#">DF2B5PCT</a>	-	-	-
		Others	<a href="#">DF2S5_1</a> ~30ASL	<a href="#">DF2S5_6</a> ~30CT	<a href="#">DF2S5_1</a> ~30FS	-	<a href="#">DF2S12FU</a> <a href="#">DF2B18FU</a> <a href="#">DF2B29FU</a> <a href="#">DF2B36FU</a>
Automotive CAN FlexRay/ LIN							

\*Thunderbolt and the Thunderbolt logo are trademarks of Intel Corporation or its subsidiaries.

\*The terms HDMI, and HDMI High-Definition Multimedia Interface, and the HDMI Logo are trademarks or registered trademarks of HDMI Licensing Administrator, Inc. in the United States and other countries.

\*Wi-Fi is a registered trademark of Wi-Fi Alliance.

\*Bluetooth® word mark is a registered trademark owned by the Bluetooth SIG, Inc.

\*Other company names, product names, and service names may be trademarks of their respective companies.

The other lineup is here.

## Diodes for RF apps

### ○High-frequency Schottky barrier diode

Low forward voltage and short reverse recovery time make it suitable for high frequency signal mixer circuits.

Product name	Circuit configuration	V <sub>R</sub> (V)	V <sub>FM</sub> Typ (V)	I <sub>R</sub>	C <sub>t</sub> Typ (pF)	@V <sub>R</sub> (V)	@f (MHz)	Package	Purchase		
				Max (μA)						@I <sub>F</sub> (mA)	
<a href="#">JDH2S02SL</a>	Single	10	0.24	1	25	0.5	0.25	0.2	1	SOD-962	<a href="#">Buy Online</a>
<a href="#">JDH2S02FS</a>	Single	10	0.24	1	25	0.5	0.4	0.2	1	SOD-923	<a href="#">Buy Online</a>
<a href="#">ISS315</a>	Single	5	0.25	2	25	0.5	0.6	0.2	1	SOD-323	<a href="#">Buy Online</a>
<a href="#">ISS154</a>	Single	6	0.5	10	0.5	5	0.8	0	1	SOT-346	<a href="#">Buy Online</a>

### ○High frequency switching diode

Used as a switch for high-frequency signals.

Ideal for switching UHF/VHF range of TV tuners, etc.

The other lineup is here.

Product name	Circuit configuration	V <sub>R</sub> (V)	C <sub>t</sub> Typ (pF)	R <sub>S</sub>	I <sub>R</sub> Max (μA)	@V <sub>R</sub> (V)	Package	Purchase				
				Typ (Ohm)					@I <sub>F</sub> (mA)	@f (MHz)		
<a href="#">ISV307</a>	Single	30	0.3	1	1	1.0	10	100	0.1	30	SOD-323	<a href="#">Buy Online</a>
<a href="#">ISV308</a>		30	0.3	1	1	1.0	10	100	0.1	30	SOD-523	<a href="#">Buy Online</a>
<a href="#">ISS381</a>	Single	30	0.7	6	1	0.6	2	100	0.1	15	SOD-523	<a href="#">Buy Online</a>
<a href="#">ISS314</a>		30	0.7	6	1	0.5	2	100	0.1	15	SOD-323	<a href="#">Buy Online</a>

The other lineup is here.

### ○Variable capacitance (VCD) diodes

Diode whose capacitance value is variable depending on the value of reverse bias voltage.

It is mainly used for high-frequency matching circuits for electronic tuning.

Product name	V <sub>R</sub> (V)	C <sub>t</sub> (1) (pF)	C <sub>t</sub> (2)	CT(1)/CT(2)	Package	Purchase				
			@V <sub>R</sub> (V)				@f (MHz)	@V <sub>R</sub> (V)	@f (MHz)	
<a href="#">ISV285</a>	10	4.5	1	1	2	4	1	2.3	SOD-523	<a href="#">Buy Online</a>
<a href="#">ISV311</a>	10	9.7 to 11.1	1	1	4.45 to 5.45	4	1	2.1	SOD-523	<a href="#">Buy Online</a>
<a href="#">ISV281</a>	10	16	1	1	8	4	1	2.0	SOD-523	<a href="#">Buy Online</a>
<a href="#">ISV305</a>	10	18.3	1	1	6.1	4	1	3.0	SOD-523	<a href="#">Buy Online</a>
<a href="#">ISV323</a>	10	26.5 to 29.5	1	1	6 to 7.1	4	1	4.3	SOD-523	<a href="#">Buy Online</a>
<a href="#">ISV325</a>	10	44 to 49.5	1	1	9.2 to 12	4	1	4.3	SOD-523	<a href="#">Buy Online</a>
<a href="#">JDV2S36E</a>	10	44 to 49.5	1	1	5.4 to 7.3	6	1	7.5	SOD-523	<a href="#">Buy Online</a>
<a href="#">ISV280</a>	15	3.8 to 4.7	2	1	1.5 to 2.0	10	1	2.4	SOD-523	<a href="#">Buy Online</a>
<a href="#">JDV2S42FS</a>	15	3.8 to 4.7	2	1	1.5 to 2.0	10	1	2.4	SOD-923	<a href="#">Buy Online</a>
<a href="#">ISV279</a>	15	14 to 16	2	1	5.5 to 6.5	10	1	2.5	SOD-523	<a href="#">Buy Online</a>
<a href="#">JDV2S41AFS</a>	15	14 to 16	2	1	5.5 to 6.5	10	1	2.5	SOD-923	<a href="#">Buy Online</a>

The other lineup is here.



## Schottky barrier diode (SBD)

### <Product Overview>

Schottky barrier diodes are devices that achieve low VF properties by joining metals and semiconductors. We range from small-signal products with a wide range of reverse voltages to products for power supply lines. In addition, by incorporating a JBS structure as compared to the conventional metal-semiconductor junction type structure, we can contribute to high-efficiency and power saving of various devices by offering a variety of low VF/ and low IR types with different performance.

### <Structural drawing>

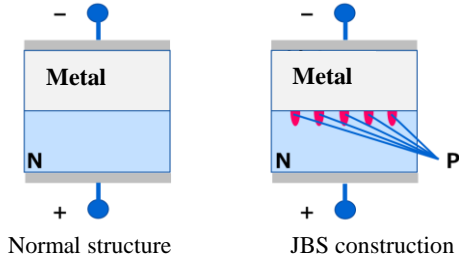

### <Circuit example>

Reverse flow (reverse connection) prevention

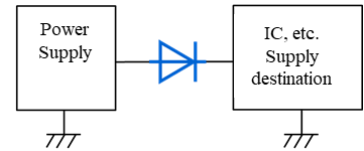

Secondary side of the switching power supply

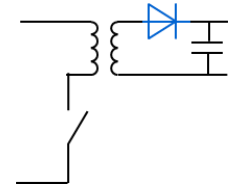

## Our Schottky barrier diode selection table

VR (V)	IF (A)	Product name	Features	VF Typ (V)	IR Max (mA)	Internal element	Package Name (Toshiba)	Dimensions (mm)	Purchase
40	0.5	<a href="#">CUS05F40</a>	Low IR	0.74	15	Single	USC	2.5 × 1.25 × 0.9	<a href="#">Buy Online</a>
		<a href="#">CUS05S40</a>	Low VF	0.56	50		USC	2.5 × 1.25 × 0.9	<a href="#">Buy Online</a>
	1.0	<a href="#">CRS10I40E</a>	High current/low IR	0.55	0.05		S-FLAT	1.6 × 3.5 × 0.98	<a href="#">Buy Online</a>
		<a href="#">CRS10I40B</a>	High current/low VF	0.45	0.1		S-FLAT	1.6 × 3.5 × 0.98	<a href="#">Buy Online</a>
		<a href="#">CUS10F40</a>	High current/low IR	0.60	20		USC	2.5 × 1.25 × 0.9	<a href="#">Buy Online</a>
		<a href="#">CUS10S40</a>	High current/low VF	0.45	150		USC	2.5 × 1.25 × 0.9	<a href="#">Buy Online</a>
	1.5	<a href="#">CMS15I40A</a>	High current/low VF	0.49	0.1		M-FLAT	2.4 × 4.7 × 0.98	<a href="#">Buy Online</a>
		<a href="#">CUHS15F40</a>	High current/low IR	0.57	50		US2H	2.5 × 1.4 × 0.6	<a href="#">Buy Online</a>
		<a href="#">CUHS15S40</a>	High current/low VF	0.45	200		US2H	2.5 × 1.4 × 0.6	<a href="#">Buy Online</a>
	2.0	<a href="#">CRS20I40B</a>	High current/low IR	0.52	0.1		S-FLAT	1.6 × 3.5 × 0.98	<a href="#">Buy Online</a>
		<a href="#">CUHS20F40</a>	High current/low IR	0.47	60		US2H	2.5 × 1.4 × 0.6	<a href="#">Buy Online</a>
		<a href="#">CUHS20S40</a>	High current/low VF	0.40	300		US2H	2.5 × 1.4 × 0.6	<a href="#">Buy Online</a>
3.0	<a href="#">CMS30I40A</a>	High current/low VF	0.55	0.1	M-FLAT	2.4 × 4.7 × 0.98	<a href="#">Buy Online</a>		
60	1.0	<a href="#">CRS10I60E</a>	High withstand voltage/low IR	0.62	0.05	S-FLAT	1.6 × 3.5 × 0.98	<a href="#">Buy Online</a>	
	1.0	<a href="#">CUHS10F60</a>	High withstand voltage/low IR	0.56	40	US2H	2.5 × 1.4 × 0.6	<a href="#">Buy Online</a>	
	1.5	<a href="#">CUHS15F60</a>	High withstand voltage/high current	0.66	50	US2H	2.5 × 1.4 × 0.6	<a href="#">Buy Online</a>	
		<a href="#">CUHS15S60</a>	High withstand voltage/low VF	0.60	450	US2H	2.5 × 1.4 × 0.6	<a href="#">Buy Online</a>	
	2.0	<a href="#">CUHS20F60</a>	High withstand voltage/high current	0.52	70	US2H	2.5 × 1.4 × 0.6	<a href="#">Buy Online</a>	
		<a href="#">CUHS20S60</a>	High withstand voltage/low VF	0.46	650	US2H	2.5 × 1.4 × 0.6	<a href="#">Buy Online</a>	

The other lineup is here.

## SiC Schottky Barrier Diode (SiC-SBD)

### <Product Overview>

The third-generation SiC Schottky Barrier Diode (SBD) offers a lineup of 650 V withstand voltage products (seven TO-220-2L packaged products and five DFN8 eight packaged products) and uses a new Schottky metal <sup>[Note 1]</sup> to optimize the junction barrier Schottky (JBS) <sup>[Note 2]</sup> construction for the second-generation products.

This achieves the industry-leading low <sup>[Note 3]</sup> of forward voltage 1.2 V (Typ.), which is approximately 17% lower than the forward voltage 1.45 V (Typ of the second-generation device).

The third-generation discrete SiC SBD contributes to lower power consumption and higher power output in a variety of devices, mainly switching power supplies.

[Note 1] A metal that is bonded to a semiconductor by a Schottky barrier diode.

[Note 2] JBS: A p-type layer is embedded in the n-type layer. Between the n and p layers when a reverse bias is applied the inverse current ( $I_R$ ) can be suppressed by expanding the depletion layer.

[Note 3] Our investigation. (As of June 2023.)

### <Cross-sectional Structural Drawing> <Circuit, evaluation conditions>

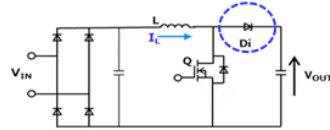
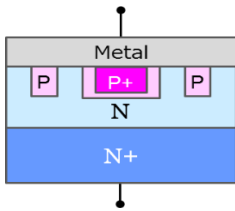

#### Measurement Condition

$V_{IN}$  = 200 V AC  
 $V_{OUT}$  = 400V DC  
 $f$  = 65 kHz  
 MOSFET: TK040Z65Z  
 MOSFET external gate resistance = 4.7 ohm  
 $T_a$  = 25 deg. C

SiC-SBD

### <Efficiency curve>

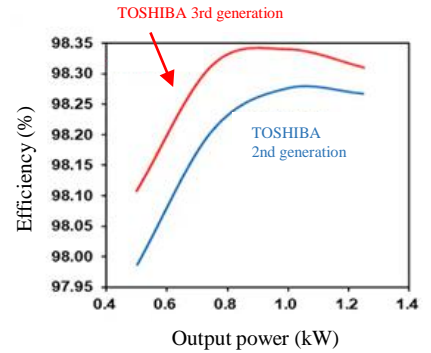

## Our SiC Schottky Barrier Diode (SiC-SBD) Selection Table

VRRM (V)	Io (A)	IFP (A)※1	IFSM (A)※2	Tj (°C)	Product name	VF Typ (V)	IR Max (μA)	C Typ. (pF)※3	Qc Typ. (nC)※3	Package Name (Toshiba)	Package appearance	Purchase			
650	2	120	19	175	<a href="#">TRS2E65H</a>	1.2	40	10	6.5	TO-220-2L		<a href="#">Buy Online</a>			
	3	170	28		<a href="#">TRS3E65H</a>		45	14	9			<a href="#">Buy Online</a>			
	4	230	36		<a href="#">TRS4E65H</a>		55	17	12			<a href="#">Buy Online</a>			
	6	310	41		<a href="#">TRS6E65H</a>		70	24	17			<a href="#">Buy Online</a>			
	8	410	56		<a href="#">TRS8E65H</a>		90	31	22			<a href="#">Buy Online</a>			
	10	510	62		<a href="#">TRS10E65H</a>		100	38	27			<a href="#">Buy Online</a>			
	12	640	74		<a href="#">TRS12E65H</a>	120	46	33	<a href="#">Buy Online</a>						
	4	230	28		<a href="#">TRS4V65H</a>	1.2	DFN8x8	55	17	12		<a href="#">Buy Online</a>			
	6	310	41		<a href="#">TRS6V65H</a>							70	24	17	<a href="#">Buy Online</a>
	8	410	45		<a href="#">TRS8V65H</a>							90	31	22	<a href="#">Buy Online</a>
	10	510	54		<a href="#">TRS10V65H</a>							100	38	27	<a href="#">Buy Online</a>
	12	640	60		<a href="#">TRS12V65H</a>							120	46	33	<a href="#">Buy Online</a>

The other lineup is here.

## RESTRICTIONS ON PRODUCT USE

Toshiba Corporation and its subsidiaries and affiliates are collectively referred to as "TOSHIBA".

Hardware, software and systems described in this document are collectively referred to as "Product".

- TOSHIBA reserves the right to make changes to the information in this document and related Product without notice.
- This document and any information herein may not be reproduced without prior written permission from TOSHIBA. Even with TOSHIBA's written permission, reproduction is permissible only if reproduction is without alteration/omission.
- Though TOSHIBA works continually to improve Product's quality and reliability, Product can malfunction or fail. Customers are responsible for complying with safety standards and for providing adequate designs and safeguards for their hardware, software and systems which minimize risk and avoid situations in which a malfunction or failure of Product could cause loss of human life, bodily injury or damage to property, including data loss or corruption. Before customers use the Product, create designs including the Product, or incorporate the Product into their own applications, customers must also refer to and comply with (a) the latest versions of all relevant TOSHIBA information, including without limitation, this document, the specifications, the data sheets and application notes for Product and the precautions and conditions set forth in the "TOSHIBA Semiconductor Reliability Handbook" and (b) the instructions for the application with which the Product will be used with or for. Customers are solely responsible for all aspects of their own product design or applications, including but not limited to (a) determining the appropriateness of the use of this Product in such design or applications; (b) evaluating and determining the applicability of any information contained in this document, or in charts, diagrams, programs, algorithms, sample application circuits, or any other referenced documents; and (c) validating all operating parameters for such designs and applications. TOSHIBA ASSUMES NO LIABILITY FOR CUSTOMERS' PRODUCT DESIGN OR APPLICATIONS.
- PRODUCT IS NEITHER INTENDED NOR WARRANTED FOR USE IN EQUIPMENTS OR SYSTEMS THAT REQUIRE EXTRAORDINARILY HIGH LEVELS OF QUALITY AND/OR RELIABILITY, AND/OR A MALFUNCTION OR FAILURE OF WHICH MAY CAUSE LOSS OF HUMAN LIFE, BODILY INJURY, SERIOUS PROPERTY DAMAGE AND/OR SERIOUS PUBLIC IMPACT ("UNINTENDED USE"). Except for specific applications as expressly stated in this document, Unintended Use includes, without limitation, equipment used in nuclear facilities, equipment used in the aerospace industry, lifesaving and/or life supporting medical equipment, equipment used for automobiles, trains, ships and other transportation, traffic signaling equipment, equipment used to control combustions or explosions, safety devices, elevators and escalators, and devices related to power plant. IF YOU USE PRODUCT FOR UNINTENDED USE, TOSHIBA ASSUMES NO LIABILITY FOR PRODUCT. For details, please contact your TOSHIBA sales representative or contact us via our website.
- Do not disassemble, analyze, reverse-engineer, alter, modify, translate or copy Product, whether in whole or in part.
- Product shall not be used for or incorporated into any products or systems whose manufacture, use, or sale is prohibited under any applicable laws or regulations.
- The information contained herein is presented only as guidance for Product use. No responsibility is assumed by TOSHIBA for any infringement of patents or any other intellectual property rights of third parties that may result from the use of Product. No license to any intellectual property right is granted by this document, whether express or implied, by estoppel or otherwise.
- ABSENT A WRITTEN SIGNED AGREEMENT, EXCEPT AS PROVIDED IN THE RELEVANT TERMS AND CONDITIONS OF SALE FOR PRODUCT, AND TO THE MAXIMUM EXTENT ALLOWABLE BY LAW, TOSHIBA (1) ASSUMES NO LIABILITY WHATSOEVER, INCLUDING WITHOUT LIMITATION, INDIRECT, CONSEQUENTIAL, SPECIAL, OR INCIDENTAL DAMAGES OR LOSS, INCLUDING WITHOUT LIMITATION, LOSS OF PROFITS, LOSS OF OPPORTUNITIES, BUSINESS INTERRUPTION AND LOSS OF DATA, AND (2) DISCLAIMS ANY AND ALL EXPRESS OR IMPLIED WARRANTIES AND CONDITIONS RELATED TO SALE, USE OF PRODUCT, OR INFORMATION, INCLUDING WARRANTIES OR CONDITIONS OF MERCHANTABILITY, FITNESS FOR A PARTICULAR PURPOSE, ACCURACY OF INFORMATION, OR NONINFRINGEMENT.
- Do not use or otherwise make available Product or related software or technology for any military purposes, including without limitation, for the design, development, use, stockpiling or manufacturing of nuclear, chemical, or biological weapons or missile technology products (mass destruction weapons). Product and related software and technology may be controlled under the applicable export laws and regulations including, without limitation, the Japanese Foreign Exchange and Foreign Trade Law and the U.S. Export Administration Regulations. Export and re-export of Product or related software or technology are strictly prohibited except in compliance with all applicable export laws and regulations.
- Please contact your TOSHIBA sales representative for details as to environmental matters such as the RoHS compatibility of Product. Please use Product in compliance with all applicable laws and regulations that regulate the inclusion or use of controlled substances, including without limitation, the EU RoHS Directive. TOSHIBA ASSUMES NO LIABILITY FOR DAMAGES OR LOSSES OCCURRING AS A RESULT OF NONCOMPLIANCE WITH APPLICABLE LAWS AND REGULATIONS.

**Toshiba Electronic Devices & Storage Corporation**

<https://toshiba.semicon-storage.com/>