

TLP104

IPM (Intelligent Power Module)

Industrial Inverter

Operate at high ambient temperatures up to 125°C

The Toshiba TLP104 consists of an infrared emitting diodes and integrated high gain, high-speed photodetectors. The TLP104 is housed in the SO6 package. The output stage is an open collector type.

The photodetector has an internal Faraday shield that provides a guaranteed common-mode transient immunity of $\pm 15 \text{ kV}/\mu\text{s}$. TLP104 guarantees minimum and maximum of propagation delay time, switching speed dispersion, and high common mode transient immunity. Therefore TLP104 is suitable for isolation interface between IPM (Intelligent Power Module) in motor control application.

- Inverter logic type (Open collector output)
- Package type: SO6
- Guaranteed performance over temperature: -40 to 125°C
- Power supply voltage: -0.5 to 30 V
- Threshold Input Current: $I_{FHL} = 5.0 \text{ mA}$ (max)
- Propagation delay time (t_{pHL}/t_{pLH}): $t_{pHL} = 400\text{ns}$ (max)
 $t_{pLH} = 550\text{ns}$ (max)
- Switching Time Dispersion($|t_{pHL}-t_{pLH}|$): 400ns (max)
- Common mode transient immunity : $\pm 15\text{kV}/\mu\text{s}$ (min)
- Isolation voltage : 3750Vrms (min)
- UL-recognized : UL 1577, File No.E67349
- cUL-recognized : CSA Component Acceptance Service No.5A
File No.E67349
- VDE-approved : EN 60747-5-5, EN 62368-1 (Note 1)
- CQC-approved : GB4943.1, GB8898 Thailand Factory



仅适用于海拔 2000m 以下地区安全使用

Note 1 : When a VDE approved type is needed, please designate the **Option(V4)**.

Truth Table

Input	LED	Output
H	ON	L
L	OFF	H

Unit: mm

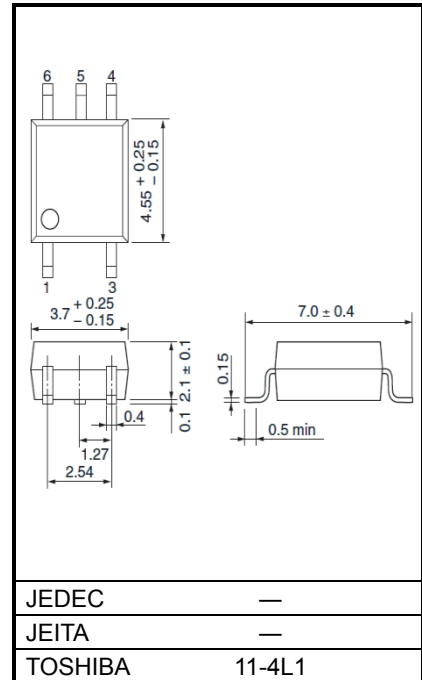

Weight: 0.08 g(typ.)

Pin Configuration (Top View)

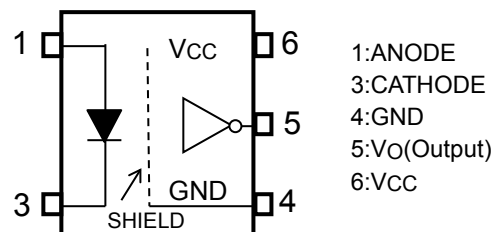

Schematic

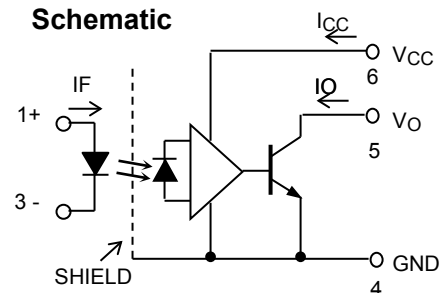

Construction Mechanical Ratings

Creepage distance	5.0 mm (min)
Clearance distance	5.0 mm (min)
Insulation thickness	0.4 mm (min)

Start of commercial production
2009-10

Absolute Maximum Ratings (Ta = 25°C)

Characteristic		Symbol	Rating	Unit
LED	Forward Current	I_F	25	mA
	Forward Current Derating (Ta ≥ 110°C)	$\Delta I_F / ^\circ C$	-0.67	mA/°C
	Pulse Forward Current (Note 1)	I_{FP}	50	mA
	Pulse Forward Current Derating (Ta ≥ 110°C)	$\Delta I_{FP} / ^\circ C$	-1.34	mA/°C
	Reverse Voltage	V_R	5	V
	Input Power Dissipation	P_D	40	mW
	Input power Dissipation Derating (Ta ≥ 110°C)	$\Delta P_D / ^\circ C$	-1.0	mW/°C
Detector	Output Current (Ta ≤ 125°C)	I_O	8	mA
	Output Voltage	V_O	-0.5 to 30	V
	Supply Voltage	V_{CC}	-0.5 to 30	V
	Output Power Dissipation	P_O	80	mW
	Output Power Dissipation Derating (Ta ≥ 110°C)	$\Delta P_O / ^\circ C$	-2.0	mW/°C
Operating Temperature Range		T_{opr}	-40 to 125	°C
Storage Temperature Range		T_{stg}	-55 to 125	°C
Lead Soldering Temperature (10 s)		T_{sol}	260	°C
Isolation Voltage (AC, 60 s, R.H. ≤ 60 %, Ta=25°C) (Note 2)		BV_S	3750	V_{rms}

Note: Using continuously under heavy loads (e.g. the application of high temperature/current/voltage and the significant change in temperature, etc.) may cause this product to decrease in the reliability significantly even if the operating conditions (i.e. operating temperature/current/voltage, etc.) are within the absolute maximum ratings.

Please design the appropriate reliability upon reviewing the Toshiba Semiconductor Reliability Handbook ("Handling Precautions"/"Derating Concept and Methods") and individual reliability data (i.e. reliability test report and estimated failure rate, etc.).

Note 1: Pulse width ≤ 10 μs, duty=10 %.

Note 2: This device is regarded as a two terminal device: pins 1 and 3 are shorted together, as are pins 4, 5 and 6.

Recommended Operating Conditions

Characteristic	Symbol	Min	Typ.	Max	Unit
Input Current , High Level	I_{FHL}	7.5	-	15	mA
Input Voltage , Low Level	V_{FLH}	0	-	0.8	V
Supply Voltage*	V_{CC}	4.5	-	30	V
Operating Temperature	T_{opr}	-40	-	125	°C

* This item denotes operating range, not meaning of recommended operating conditions.

Note: Recommended operating conditions are given as a design guideline to obtain expected performance of the device. Additionally, each item is an independent guideline respectively. In developing designs using this product, please confirm specified characteristics shown in this document.

Electrical Characteristics

(Unless otherwise specified, $T_a = -40$ to 125°C , $V_{CC} = 4.5$ to 30V)

Characteristic		Symbol	Test Circuit	Test Condition	Min	Typ.	Max	Unit
LED	Forward voltage	V_F	—	$I_F = 10\text{ mA}$, $T_a = 25^\circ\text{C}$	1.45	1.61	1.85	V
	Forward voltage temperature coefficient	$\Delta V_F / \Delta T_a$	—	$I_F = 10\text{ mA}$	—	-1.8	—	mV/°C
	Reverse current	I_R	—	$V_R = 5\text{ V}$, $T_a = 25^\circ\text{C}$	—	—	10	μA
	Capacitance between terminals	C_T	—	$V = 0\text{ V}$, $f = 1\text{ MHz}$	—	60	—	pF
Detector	High level output current	I_{OH}	1	$V_F = 0.8\text{ V}$, $V_O < V_{CC}$	—	—	50	μA
	Low level output voltage	V_{OL}	2	$I_F = 10\text{ mA}$, $I_O = 2.4\text{ mA}$	—	0.2	0.6	V
	Low level supply current	I_{CCL}	3	$I_F = 10\text{ mA}$	—	—	1.3	mA
	High level supply current	I_{CCH}	4	$I_F = 0\text{ mA}$	—	—	1.3	mA
	Output current	I_O	—	$I_F = 10\text{ mA}$, $V_O = 0.6\text{ V}$	4.0	—	—	mA
Input current logic LOW output	I_{FHL}	—	$I_O = 0.75\text{ mA}$, $V_O < 0.8\text{ V}$	—	1.0	5	mA	
Input voltage logic HIGH output	V_{FLH}	—	$I_O = 0.75\text{ mA}$, $V_O > 2.0\text{ V}$	0.8	—	—	V	

*All typical values are at $T_a = 25^\circ\text{C}$, $V_{CC} = 5\text{ V}$ unless otherwise specified

Isolation Characteristics ($T_a = 25^\circ\text{C}$)

Characteristic	Symbol	Test Conditions	Min	Typ.	Max	Unit
Capacitance input to output	C_S	$V_S = 0\text{ V}$, $f = 1\text{ MHz}$	—	0.8	—	pF
Isolation resistance	R_S	R.H. $\leq 60\%$, $V_S = 500\text{ V}$	1×10^{12}	10^{14}	—	Ω
Isolation voltage	BV_S	AC, 60 s	3750	—	—	V_{rms}

Switching Characteristics (Unless otherwise specified, $T_a = -40$ to 125°C , $V_{CC}=15\text{V}$)

Characteristic	Symbol	Test Circuit	Test Condition	Min	Typ.	Max	Unit	
Propagation delay time (H→L)	t_{pHL}	5	$I_F = 10\text{ mA}$, $R_L = 20\text{ k}\Omega$ (Note 1)	$C_L = 100\text{ pF}$	30	150	400	ns
Propagation delay time (L→H)	t_{pLH}			$C_L = 10\text{ pF}$	—	90	—	
				$C_L = 100\text{ pF}$	150	350	550	
Switching Time Dispersion between ON and OFF	$ t_{pHL} - t_{pLH} $			$C_L = 100\text{ pF}$	—	—	400	
Propagation Delay Skew (Note 2)	$t_{pLH} - t_{pHL}$				-50	—	450	
Common mode transient immunity at high output level	CMH	6	$V_{CM} = 1500\text{ V}_{p-p}$, $I_F = 0\text{ mA}$ $R_L = 20\text{ k}\Omega$, $T_a = 25^\circ\text{C}$	15	—	—	kV/ μs	
Common mode transient immunity at low output level	CM _L		$V_{CM} = 1500\text{ V}_{p-p}$, $I_F = 10\text{ mA}$ $R_L = 20\text{ k}\Omega$, $T_a = 25^\circ\text{C}$	-15	—	—	kV/ μs	

*All typical values are at $T_a = 25^\circ\text{C}$

Note : A ceramic capacitor (0.1 μF) should be connected from pin 6 (V_{CC}) to pin 4 (GND) to stabilize the operation of the high gain linear amplifier. Failure to provide the bypass may impair the switching property.

The total lead length between capacitor and coupler should not exceed 1 cm.

Note 1: $f = 10\text{kHz}$, duty=10%, input current $t_r = t_f = 5\text{ ns}$

Note 2: Propagation delay skew is defined as the propagation delay time of the largest or smallest t_{pLH} minus the largest or smallest t_{pHL} of multiple samples. Evaluations of these samples are conducted under identical test conditions (supply voltage, input current, temperature, etc.).

TEST CIRCUIT 1: I_{OH}

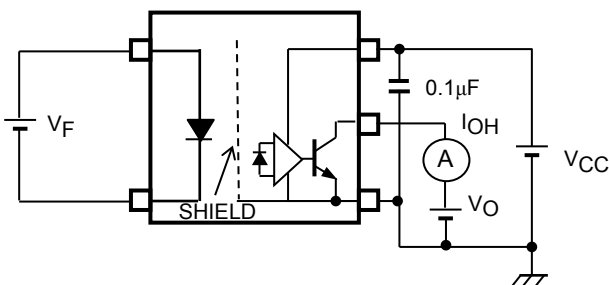

TEST CIRCUIT 2: V_{OL}

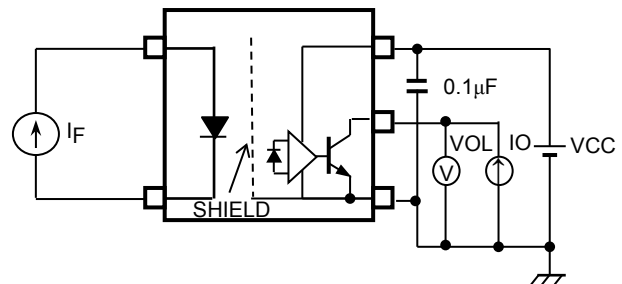

TEST CIRCUIT 3: I_{CCL}

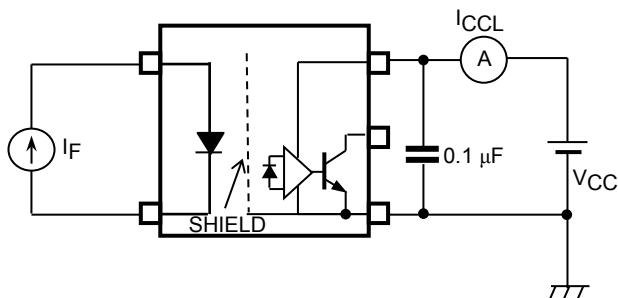

TEST CIRCUIT 4: I_{CCH}

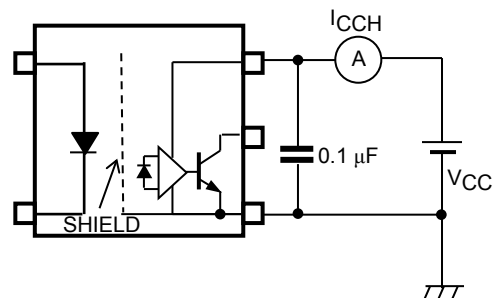

Test Circuit 5: t_{pHL} , t_{pLH} , $|t_{pHL}-t_{pLH}|$

$I_F=10\text{mA(P.G)}$
 ($f=10\text{kHz}$, $\text{duty}=10\%$, $t_r=t_f=5\text{ns}$)

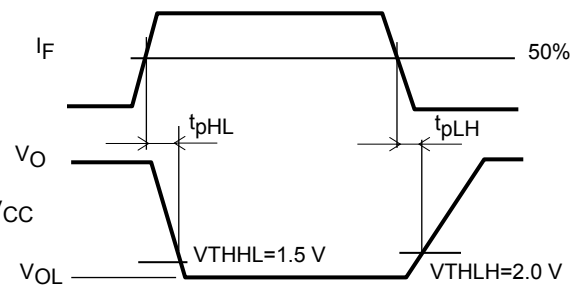
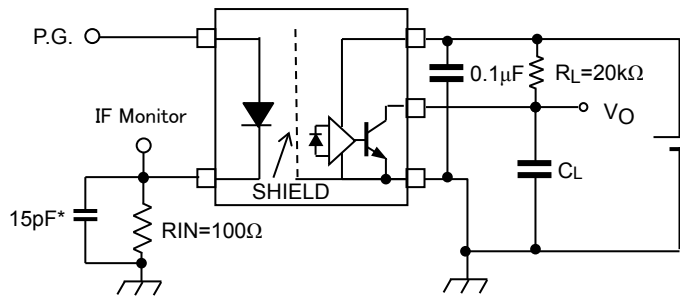

*: probe and stray capacitance.
 P.G.: Pulse generator

Test Circuit 6: CM_H , CM_L

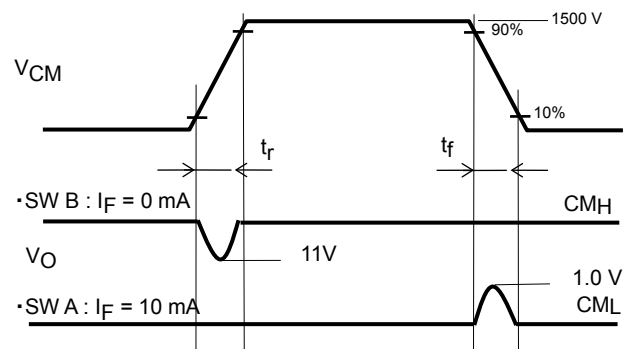
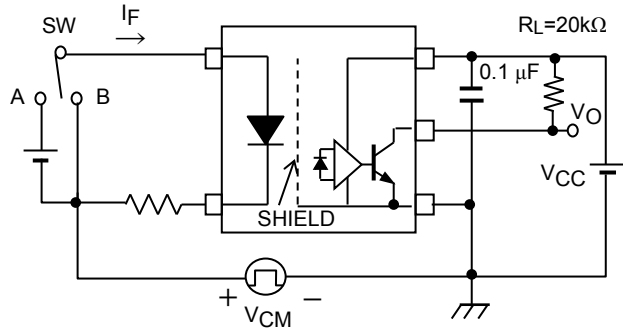

$$CM_H = \frac{1200(V)}{t_r(\mu s)} \quad CM_L = -\frac{1200(V)}{t_f(\mu s)}$$

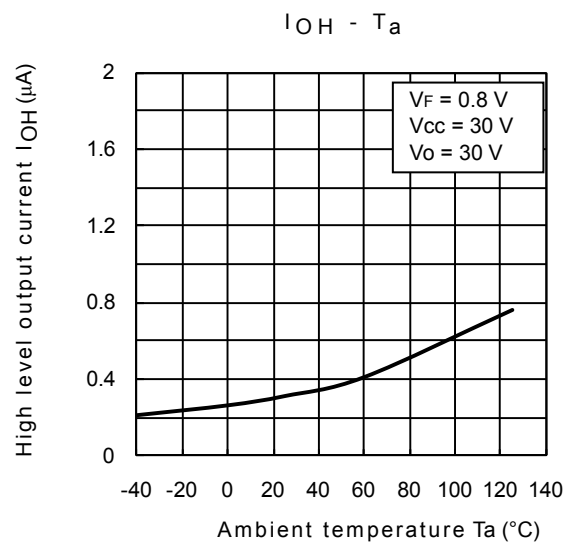
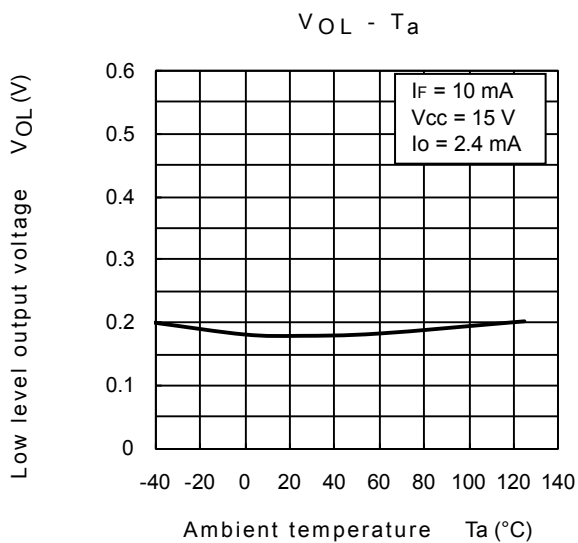
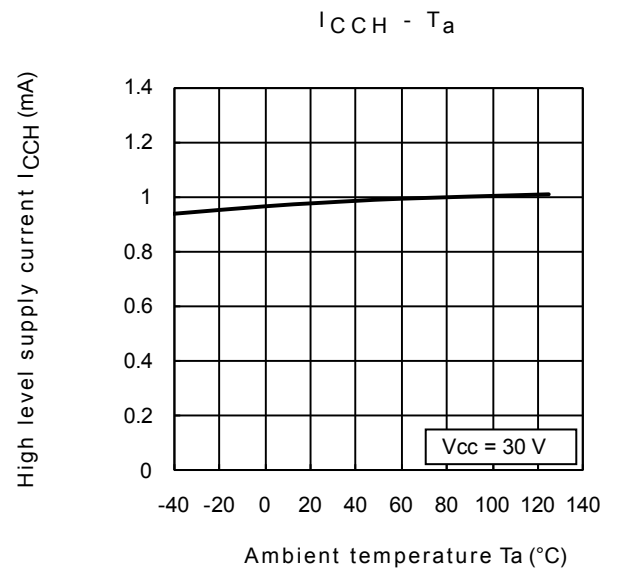
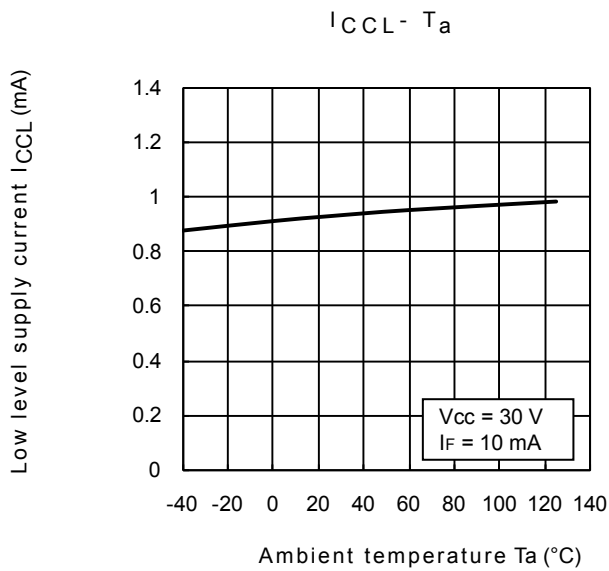
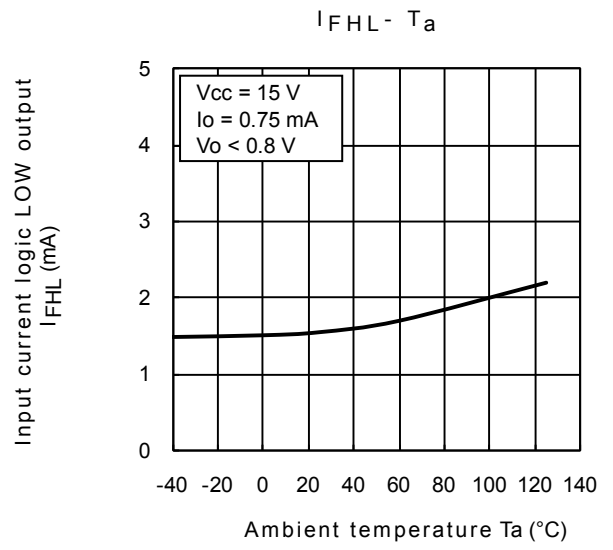
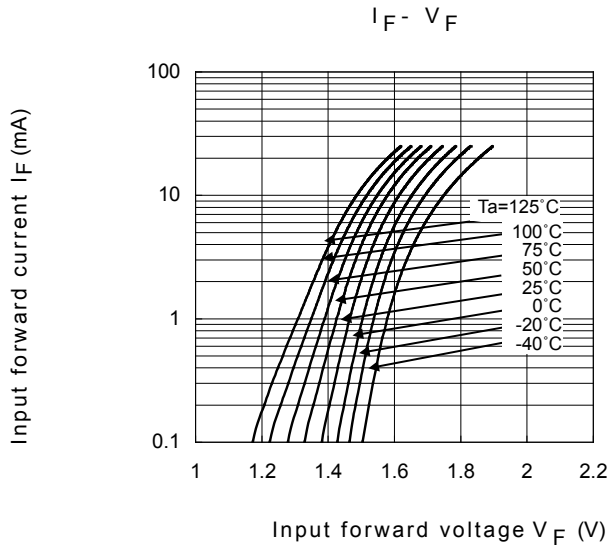

NOTE: The above characteristics curves are presented for reference only and not guaranteed by production test, unless otherwise noted.

$t_{PHL}/t_{PLH}/|t_{PLH}-t_{PHL}| - C_L$

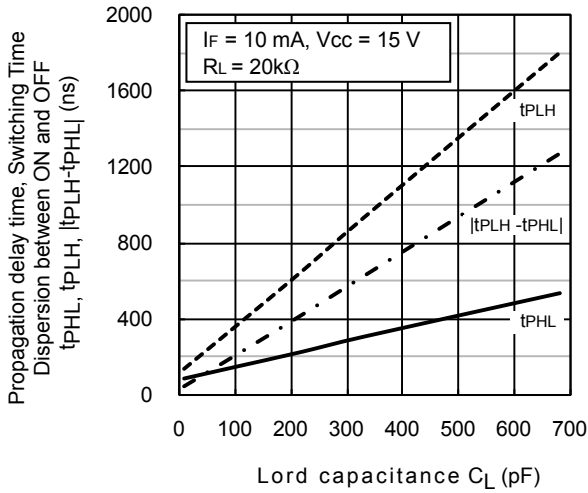

$t_{PHL}/t_{PLH}/|t_{PLH}-t_{PHL}| - T_a$

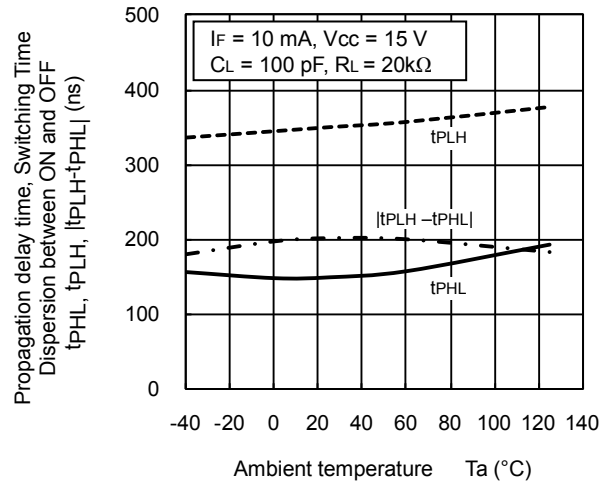

$t_{PHL}/t_{PLH}/|t_{PLH}-t_{PHL}| - I_F$

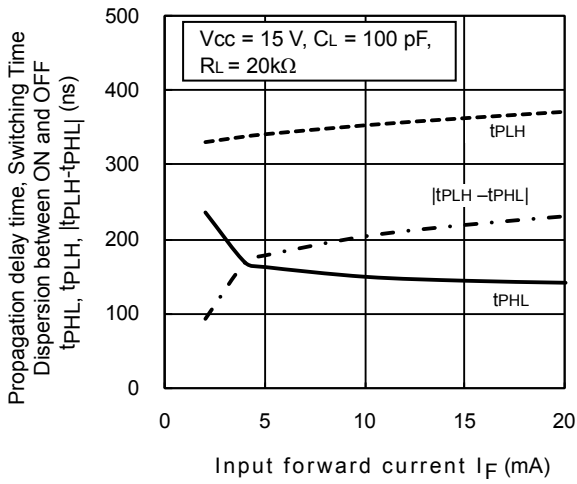

$t_{PHL}/t_{PLH}/|t_{PLH}-t_{PHL}| - V_{CC}$

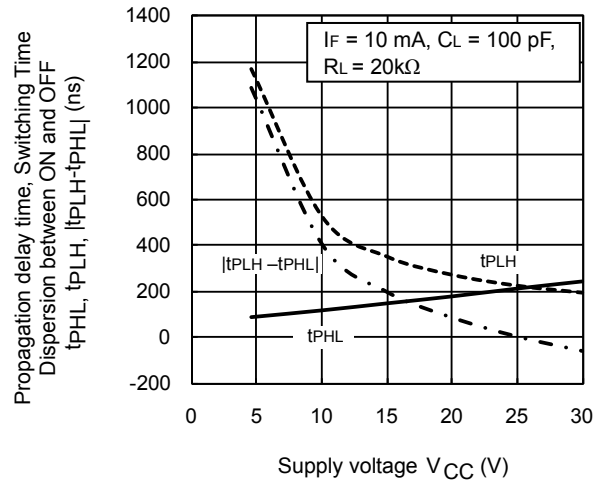

$t_{PHL}/t_{PLH}/|t_{PLH}-t_{PHL}| - R_L$

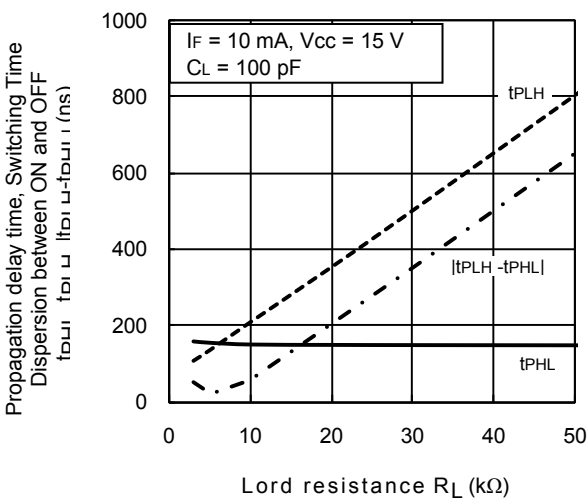

$t_{PHL}/t_{PLH}/|t_{PLH}-t_{PHL}| - R_L$

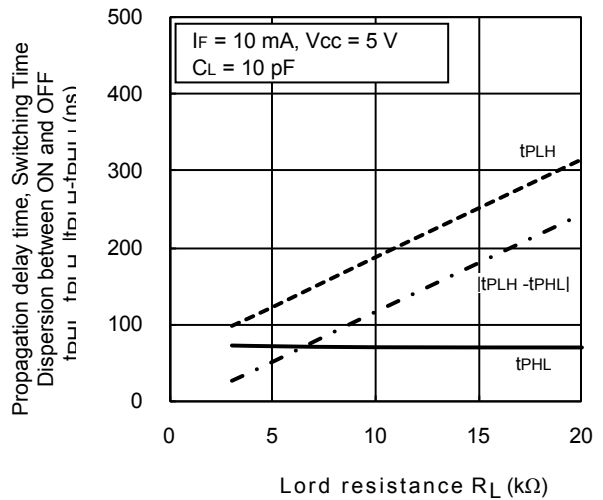

NOTE: The above characteristics curves are presented for reference only and not guaranteed by production test, unless otherwise noted.

PRECAUTIONS OF SURFACE MOUNTING TYPE PHOTOCOUPLER SOLDERING & GENERAL STORAGE

● Precautions for Soldering

The soldering temperature should be controlled as closely as possible to the conditions shown below, irrespective of whether a soldering iron or a reflow soldering method is used.

1) When Using Soldering Reflow

The soldering temperature profile is based on the package surface temperature.

(See the figure shown below.)

An example of a temperature profile when lead (Pb)-free solder is used

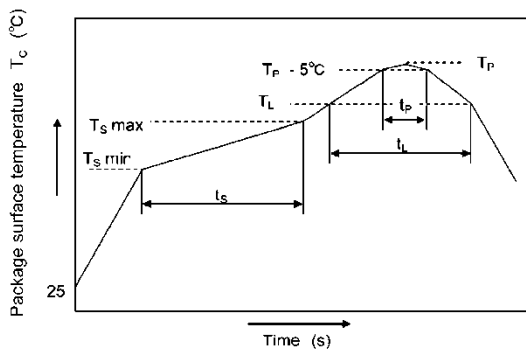

	Symbol	Min	Max	Unit
Preheat temperature	T_S	150	200	°C
Preheat time	t_s	60	120	s
Ramp-up rate (T_L to T_P)			3	°C/s
Liquidus temperature	T_L	217		°C
Time above T_L	t_L	60	150	s
Peak temperature	T_P		260	°C
Time during which T_c is between ($T_P - 5$) and T_P	t_p		30	s
Ramp-down rate (T_P to T_L)			6	°C/s

- Reflow soldering must be performed once or twice.
- The mounting should be completed with the interval from the first to the last mountings being 2 weeks.

2) When using soldering Flow

- Apply preheating of 150 °C for 60 to 120 seconds.
- Mounting condition of 260 °C or less within 10 seconds is recommended.
- Flow soldering must be performed once

3) When using soldering Iron

- Complete soldering within 10 seconds for lead temperature not exceeding 260 °C or within 3 seconds not exceeding 350 °C.
- Heating by soldering iron must be only once per 1 lead

(2) Precautions for General Storage

- 1) Do not store devices at any place where they will be exposed to moisture or direct sunlight.
- 2) When transportation or storage of devices, follow the cautions indicated on the carton box.
- 3) The storage area temperature should be kept within a temperature range of 5 °C to 35 °C, and relative humidity should be maintained at between 45% and 75%.
- 4) Do not store devices in the presence of harmful (especially corrosive) gases, or in dusty conditions.
- 5) Use storage areas where there is minimal temperature fluctuation. Because rapid temperature changes can cause condensation to occur on stored devices, resulting in lead oxidation or corrosion, as a result, the solderability of the leads will be degraded.
- 6) When repacking devices, use anti-static containers.
- 7) Do not apply any external force or load directly to devices while they are in storage.
- 8) If devices have been stored for more than two years, even though the above conditions have been followed, it is recommended that solderability of them should be tested before they are used.

Specification for Embossed-Tape Packing (TPL)(TPR) for SO6 Coupler

1. Applicable Package

Package	Product Type
SO6	Mini-flat coupler

2. Product Naming System

Type of package used for shipment is denoted by a symbol suffix after a product number. The method of classification is as below.

(Example)

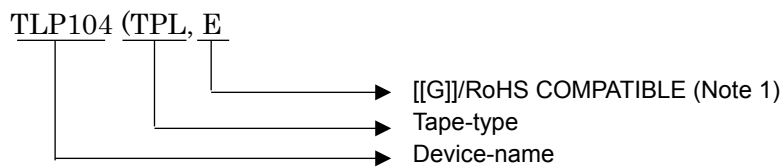

Note 1: Please contact your Toshiba sales representative for details on environmental information such as the product's RoHS compatibility. RoHS is the Directive 2011/65/EU of the European Parliament and of the Council of 8 June 2011 on the restriction of the use of certain hazardous substances in electrical and electronic equipment.

3. Tape Dimensions

3.1 Specification Classification Are as Shown in Table 1

Table 1 Tape Type Classification

Tape type	Classification	Quantity (pcs / reel)
TPL	L direction	3000
TPR	R direction	3000

3.2 Orientation of Device in Relation to Direction of Tape Movement

Device orientation in the recesses is as shown in Figure 1.

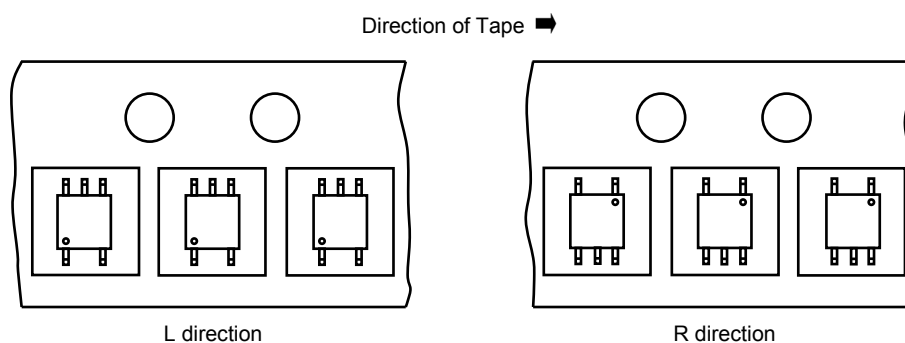

Figure 1 Device Orientation

3.3 Empty Device Recesses Are as Shown in Table 2.

Table 2 Empty Device Recesses

	Standard	Remarks
Occurrences of 2 or more successive empty device recesses	0 device	Within any given 40 mm section of tape, not including leader and trailer
Single empty device recesses	6 devices (max) per reel	Not including leader and trailer

3.4 Start and End of Tape

The start of the tape has 50 or more empty holes. The end of tape has 50 or more empty holes and two empty turns only for a cover tape.

3.5 Tape Specification

- (1) Tape material: Plastic (protection against electrostatics)
- (2) Dimensions: The tape dimensions are as shown in Figure 2 and Table 3.

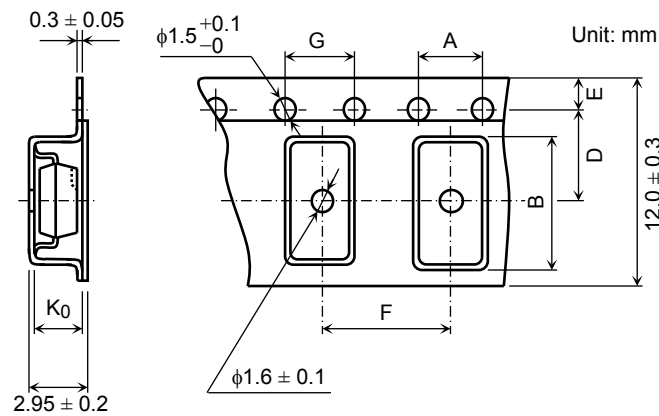

Figure 2 Tape Forms

Table 3 Tape Dimensions

Unit: mm
Unless otherwise specified: ±0.1

Symbol	Dimension	Remark
A	4.0	—
B	7.6	—
D	5.5	Center line of indented square hole and sprocket hole
E	1.75	Distance between tape edge and hole center
F	8.0	Cumulative error $\begin{matrix} +0.1 \\ -0.3 \end{matrix}$ (max) per 10 feed holes
G	4.0	Cumulative error $\begin{matrix} +0.1 \\ -0.3 \end{matrix}$ (max) per 10 feed holes
K0	2.6	Internal space

3.6 Reel

- (1) Material: Plastic
- (2) Dimensions: The reel dimensions are as shown in Figure 3 and Table 4.

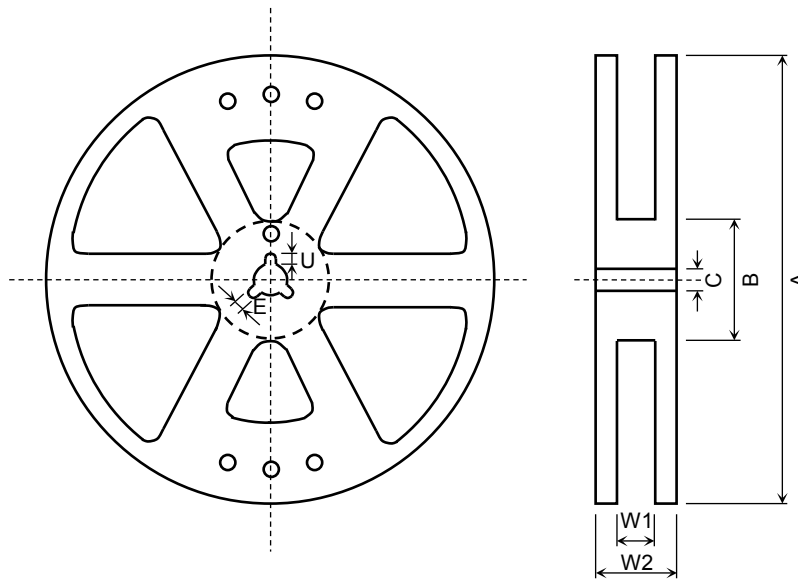

Figure 3 Reel Form

Table 4 Reel Dimensions

Unit: mm

Symbol	Dimension
A	$\Phi 380 \pm 2$
B	$\Phi 80 \pm 1$
C	$\Phi 13 \pm 0.5$
E	2.0 ± 0.5
U	4.0 ± 0.5
W1	13.5 ± 0.5
W2	17.5 ± 1.0

4. Packing

Packed in a shipping carton.

5. Label Indication

The carton bears a label indicating the product number, the symbol representing classification of standard, the quantity, the lot number and the Toshiba company name.

6. Ordering Method

When placing an order, please specify the product number, the tape type and the quantity as shown in the following example.

(Example)

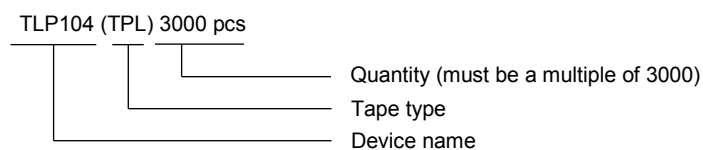

RESTRICTIONS ON PRODUCT USE

Toshiba Corporation and its subsidiaries and affiliates are collectively referred to as "TOSHIBA". Hardware, software and systems described in this document are collectively referred to as "Product".

- TOSHIBA reserves the right to make changes to the information in this document and related Product without notice.
- This document and any information herein may not be reproduced without prior written permission from TOSHIBA. Even with TOSHIBA's written permission, reproduction is permissible only if reproduction is without alteration/omission.
- Though TOSHIBA works continually to improve Product's quality and reliability, Product can malfunction or fail. Customers are responsible for complying with safety standards and for providing adequate designs and safeguards for their hardware, software and systems which minimize risk and avoid situations in which a malfunction or failure of Product could cause loss of human life, bodily injury or damage to property, including data loss or corruption. Before customers use the Product, create designs including the Product, or incorporate the Product into their own applications, customers must also refer to and comply with (a) the latest versions of all relevant TOSHIBA information, including without limitation, this document, the specifications, the data sheets and application notes for Product and the precautions and conditions set forth in the "TOSHIBA Semiconductor Reliability Handbook" and (b) the instructions for the application with which the Product will be used with or for. Customers are solely responsible for all aspects of their own product design or applications, including but not limited to (a) determining the appropriateness of the use of this Product in such design or applications; (b) evaluating and determining the applicability of any information contained in this document, or in charts, diagrams, programs, algorithms, sample application circuits, or any other referenced documents; and (c) validating all operating parameters for such designs and applications. **TOSHIBA ASSUMES NO LIABILITY FOR CUSTOMERS' PRODUCT DESIGN OR APPLICATIONS.**
- **PRODUCT IS NEITHER INTENDED NOR WARRANTED FOR USE IN EQUIPMENTS OR SYSTEMS THAT REQUIRE EXTRAORDINARILY HIGH LEVELS OF QUALITY AND/OR RELIABILITY, AND/OR A MALFUNCTION OR FAILURE OF WHICH MAY CAUSE LOSS OF HUMAN LIFE, BODILY INJURY, SERIOUS PROPERTY DAMAGE AND/OR SERIOUS PUBLIC IMPACT ("UNINTENDED USE").** Except for specific applications as expressly stated in this document, Unintended Use includes, without limitation, equipment used in nuclear facilities, equipment used in the aerospace industry, lifesaving and/or life supporting medical equipment, equipment used for automobiles, trains, ships and other transportation, traffic signaling equipment, equipment used to control combustions or explosions, safety devices, elevators and escalators, and devices related to power plant. **IF YOU USE PRODUCT FOR UNINTENDED USE, TOSHIBA ASSUMES NO LIABILITY FOR PRODUCT.** For details, please contact your TOSHIBA sales representative or contact us via our website.
- Do not disassemble, analyze, reverse-engineer, alter, modify, translate or copy Product, whether in whole or in part.
- Product shall not be used for or incorporated into any products or systems whose manufacture, use, or sale is prohibited under any applicable laws or regulations.
- The information contained herein is presented only as guidance for Product use. No responsibility is assumed by TOSHIBA for any infringement of patents or any other intellectual property rights of third parties that may result from the use of Product. No license to any intellectual property right is granted by this document, whether express or implied, by estoppel or otherwise.
- **ABSENT A WRITTEN SIGNED AGREEMENT, EXCEPT AS PROVIDED IN THE RELEVANT TERMS AND CONDITIONS OF SALE FOR PRODUCT, AND TO THE MAXIMUM EXTENT ALLOWABLE BY LAW, TOSHIBA (1) ASSUMES NO LIABILITY WHATSOEVER, INCLUDING WITHOUT LIMITATION, INDIRECT, CONSEQUENTIAL, SPECIAL, OR INCIDENTAL DAMAGES OR LOSS, INCLUDING WITHOUT LIMITATION, LOSS OF PROFITS, LOSS OF OPPORTUNITIES, BUSINESS INTERRUPTION AND LOSS OF DATA, AND (2) DISCLAIMS ANY AND ALL EXPRESS OR IMPLIED WARRANTIES AND CONDITIONS RELATED TO SALE, USE OF PRODUCT, OR INFORMATION, INCLUDING WARRANTIES OR CONDITIONS OF MERCHANTABILITY, FITNESS FOR A PARTICULAR PURPOSE, ACCURACY OF INFORMATION, OR NONINFRINGEMENT.**
- GaAs (Gallium Arsenide) is used in Product. GaAs is harmful to humans if consumed or absorbed, whether in the form of dust or vapor. Handle with care and do not break, cut, crush, grind, dissolve chemically or otherwise expose GaAs in Product.
- Do not use or otherwise make available Product or related software or technology for any military purposes, including without limitation, for the design, development, use, stockpiling or manufacturing of nuclear, chemical, or biological weapons or missile technology products (mass destruction weapons). Product and related software and technology may be controlled under the applicable export laws and regulations including, without limitation, the Japanese Foreign Exchange and Foreign Trade Law and the U.S. Export Administration Regulations. Export and re-export of Product or related software or technology are strictly prohibited except in compliance with all applicable export laws and regulations.
- Please contact your TOSHIBA sales representative for details as to environmental matters such as the RoHS compatibility of Product. Please use Product in compliance with all applicable laws and regulations that regulate the inclusion or use of controlled substances, including without limitation, the EU RoHS Directive. **TOSHIBA ASSUMES NO LIABILITY FOR DAMAGES OR LOSSES OCCURRING AS A RESULT OF NONCOMPLIANCE WITH APPLICABLE LAWS AND REGULATIONS.**