

Package dimensions  
LQFP48-P-0707-0.50D

"Unit:mm"

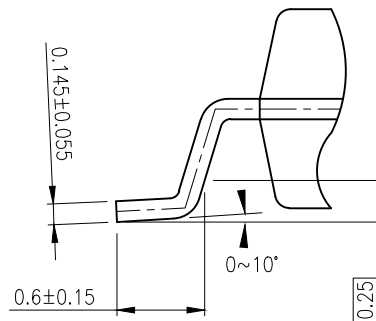
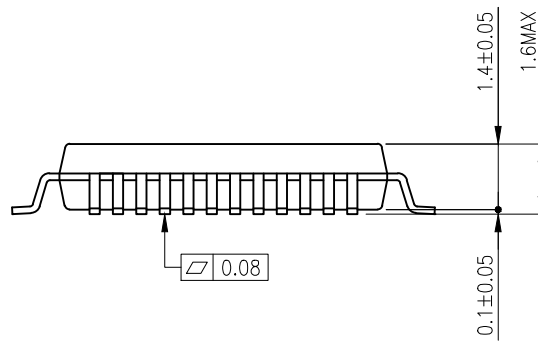
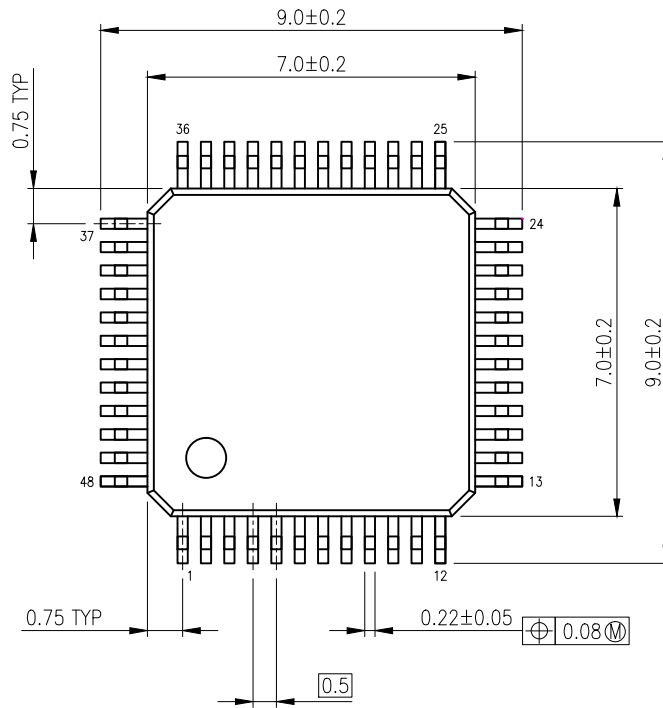

Before creating and producing designs and using, customers must also refer to and comply with the latest versions of all relevant TOSHIBA information and the instructions for the application that Product will be used with or for.

## Package Image

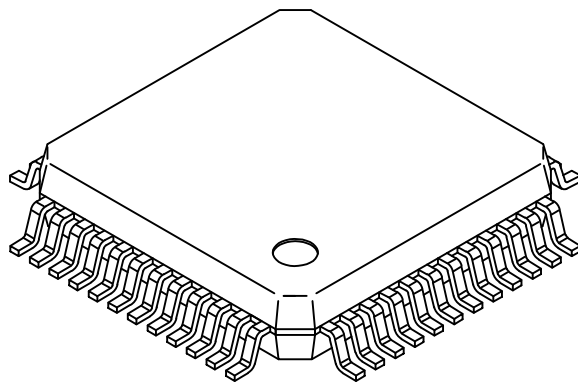

Before creating and producing designs and using, customers must also refer to and comply with the latest versions of all relevant TOSHIBA information and the instructions for the application that Product will be used with or for.