

**M3H Group(1)**  
**Application Note**  
**Clock Control and Operation Mode**  
**(CG-M3H(1)-D)**

**Outlines**

This application note is a reference material for developing products using clock control and operation mode (CG) functions of M3H Group(1).  
This document helps the user check operation of the product and develop its program.

Target sample program: CGRST

**Table of Contents**

Outlines .....	1
Table of Contents .....	2
1. Preface .....	3
2. Reference Document .....	3
3. Function to Use .....	4
4. Target Device .....	4
5. Operation confirmation condition .....	5
6. Evaluation Board Setting .....	6
7. Operation of Evaluation Board .....	7
8. Outline of clock control function .....	8
9. Sample Program .....	9
9.1. Initialization .....	9
9.2. Sample program main operation .....	9
9.3. Operating Mode Switching .....	9
9.4. Operating Flow of Sample Program .....	10
10. Precaution .....	21
11. Revision History .....	21
RESTRICTIONS ON PRODUCT USE .....	22

### 1. Preface

CG function sets the clock gear, the prescaler clock selection, the warm-up interval of the oscillator, and others.

This sample program operates on the evaluation board. The operation mode can be changed from Normal mode to Low power mode by controlling Push switch on the evaluation board. The operation mode state can be checked with the LED.

Structure diagram of Sample program

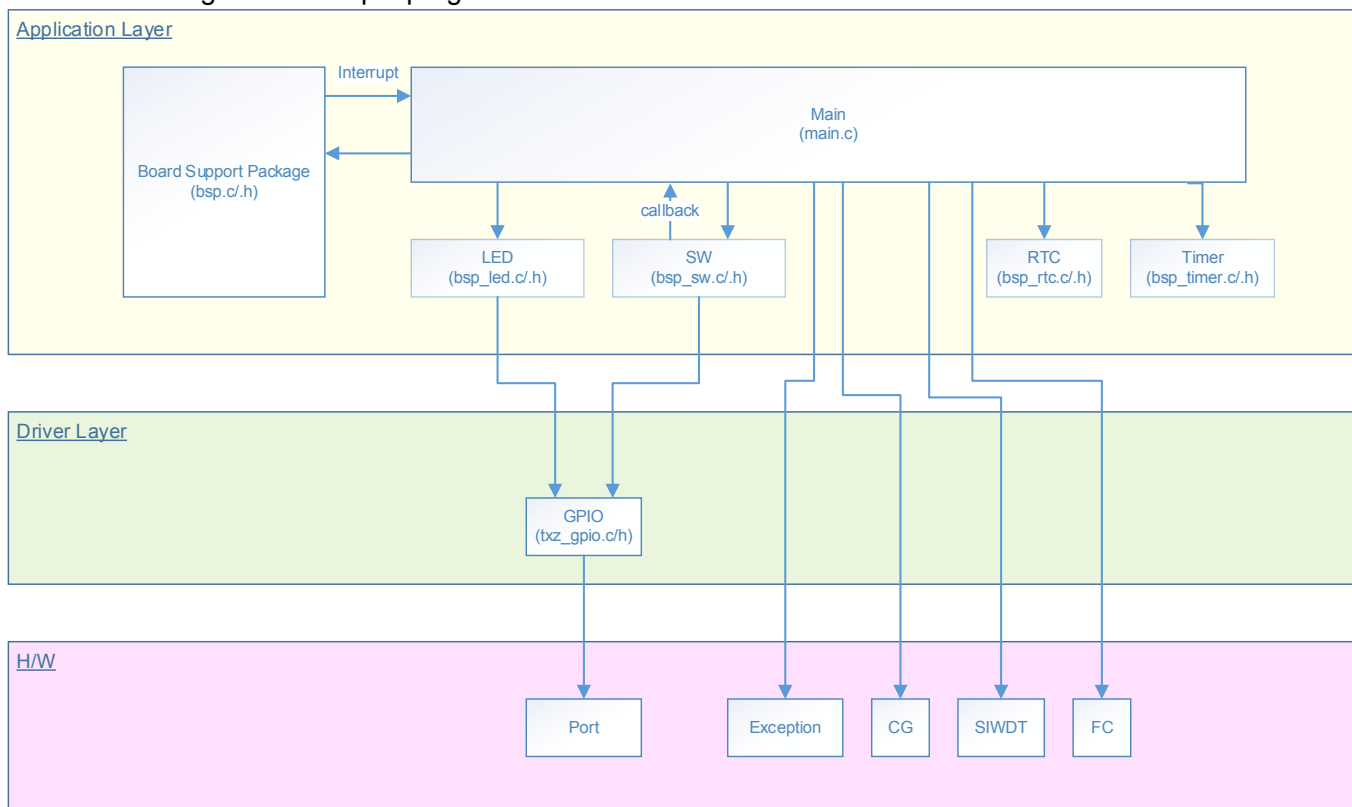

### 2. Reference Document

- Datasheet  
TMPM3H group (1) datasheet Rev2.0 (Japanese edition)
- Reference manual  
Clock Control and Operating Mode (CG-M3H(1)-D) Rev2.0 (Japanese edition)
- Other reference document  
TMPM3H Group Peripheral Driver User Manual (Doxygen)

### 3. Function to Use

IP	channel	port	Function / operation mode
Clock control	–	–	System clock control/Mode switching
Input and output port	–	PN1 (Input Port) PN2 (Input Port) PN3 (Input Port)	Mode switching
	–	PB4 (Output Port) PB5 (Output Port) PB6 (Output Port) PB7 (Output Port)	LED lighting control terminal
Real time clock	–	–	Low Power Mode Timeout

### 4. Target Device

The target devices of application note are as follows.

TMPM3H6FWFG	TMPM3H6FUFG	TMPM3H6FSFG
TMPM3H6FWDFG	TMPM3H6FUDFG	TMPM3H6FSDFG
TMPM3H5FWFG	TMPM3H5FUFG	TMPM3H5FSFG
TMPM3H5FWDFG	TMPM3H5FUDFG	TMPM3H5FSDFG
TMPM3H4FWUG	TMPM3H4FUUG	TMPM3H4FSUG
TMPM3H4FWFG	TMPM3H4FUFG	TMPM3H4FSFG
TMPM3H3FWUG	TMPM3H3FUUG	TMPM3H3FSUG
TMPM3H2FWDUG	TMPM3H2FUDUG	TMPM3H2FSDUG
TMPM3H2FWQG	TMPM3H2FUQG	TMPM3H2FSQG
TMPM3H1FWUG	TMPM3H1FUUG	TMPM3H1FSUG
TMPM3H1FPUG	TMPM3H0FSDUG	TMPM3H0FMDUG

\* This sample program operates on the evaluation board of TMPM3H6FWFG.

If other function than the TMPM3H6 one is checked, it is necessary that CMSIS Core related files (C startup file and I/O header file) should be changed properly.

The BSP related file is dedicated to the evaluation board (TMPM3H6). If other function than the TMPM3H6 one is checked, the BSP related file should be changed properly.

This sample program uses the RTC function.

Because TMPM3H1 and TMPM3H0 are not supported with RTC, operation check with this sample program can not be executed.

## 5. Operation confirmation condition

Used microcontroller    TPM3H6FWFG  
Used board                TPM3H6FWFG Evaluation Board (Product of Sensyst)  
Unified development environment    IAR Embedded Workbench for ARM 8.11.2.13606  
Unified development environment     $\mu$ Vision MDK Version 5.24.2.0  
Sample program        V1100

Evaluation board (TPM3H6FWFG Evaluation Board) (Top view)

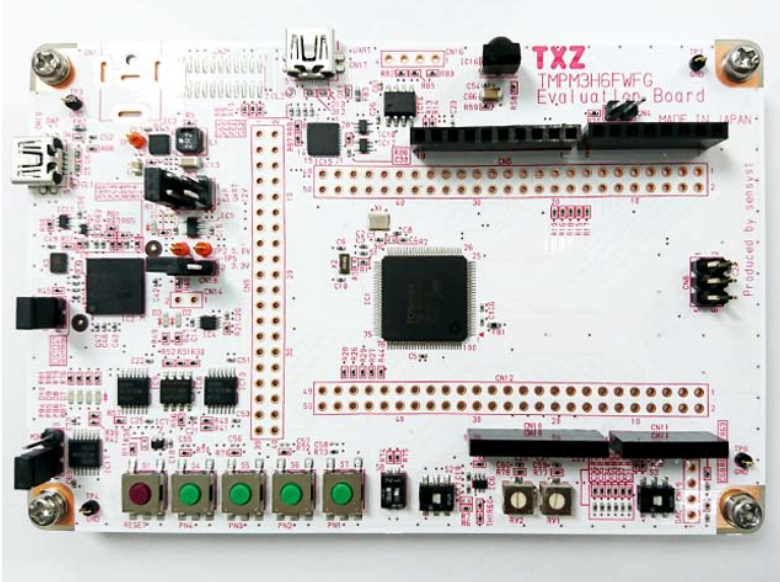

For purchasing the board, refer to the following homepage. (<http://www.chip1stop.com/>)

## 6. Evaluation Board Setting

The following pin connections should be done on the evaluation board.

CN5		
Use	Through-hole No.	Setting
LED (D10)	27-28	Connection
LED (D9)	29-30	Connection
LED (D8)	31-32	Connection
LED (D7)	33-34	Connection

CN9		
Use	Through-hole No.	Setting
Push SW (S4)	19-20	Connection
Push SW (S5)	21-22	Connection
Push SW (S6)	23-24	Connection
Push SW (S7)	25-26	Connection

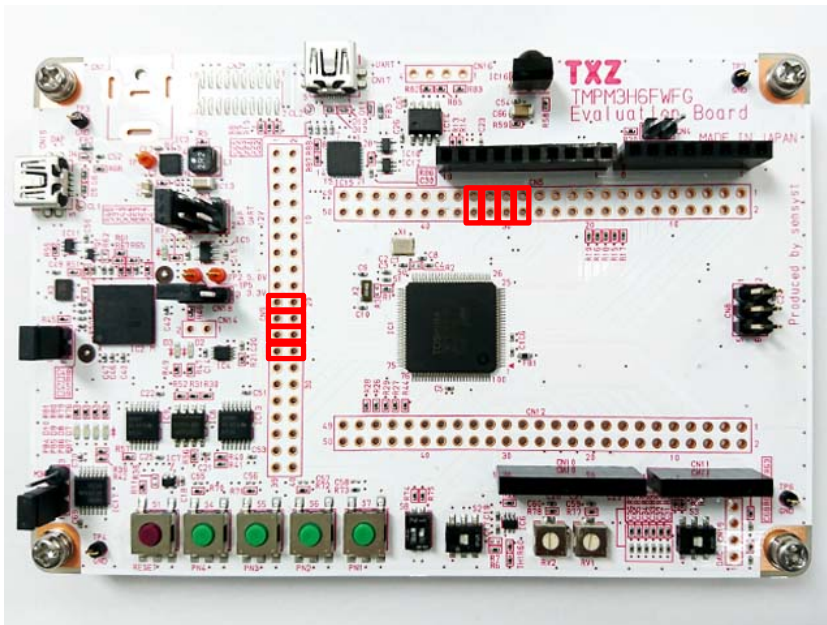

## 7. Operation of Evaluation Board

The initial mode is the Normal mode.

After the reset is deasserted, the controller operates in the Normal mode. The LED on PB4 blinks.

The mode can be changed to one of the Low power modes by the Push switch.

IDLE S7: Port N1

STOP1 S6: Port N2

STOP2 S5: Port N3

The LED's show the current operating mode.

The LED blinking pattern depends on an operating mode, shown as follows:-

Normal mode : Port B4 (Blink)

Low power mode IDLE: Port B5 (LED On)

STOP1: Port B6 (LED On)

STOP2: Port B7 (LED On)

LED blink frequency

Normal mode: LED On for 1 second -> LED Off for 1 second, and it repeats.

Low power mode IDLE: LED On

STOP1: LED On

STOP2: LED On

The controller enters one of the Low power modes. Then, the operation mode changes to the Normal mode after the following RTC setting interval elapses.

RTC setting interval: 1 minute

## 8. Outline of clock control function

The operation mode consists of the Normal mode and the Low power modes. The power consumption can be saved by transition of the operation modes according to the application.

The clock control available are shown as follows:

- System clock control  
As the source of the system clock, the internal high speed oscillation clock and the external high speed oscillation clock (connection of a crystal oscillator or a clock input) can be used.
- Prescaler clock control  
Each peripheral function has a prescaler to divide the clock  $\phi T0$ .

The clock function has the following operation modes.

- Normal mode
- Low power mode (3 modes)  
IDLE/STOP1/STOP2

Operating mode	Name	Description
Normal mode	Normal	Normal operation.
Low power mode	IDLE	CPU stops. Peripheral functions can operate.
	STOP1	System clock stops. Low frequency clock can operate.
	STOP2	System clock stops. Power supply for the internal circuits is shut down.

The operation mode can be changed by the Push switch in this sample program. And the operation mode is shown by the LED blinking pattern.



## 9. Sample Program

The port input signal from the Push switch is a trigger to change to the Low power mode (IDLE/STOP1/STOP2).  
A corresponding LED turns on at the transition to the Low power mode.  
The operation mode of the CPU shift to normal mode by RTC interrupt.

### 9.1. Initialization

The following initialization is done after power is supplied.  
The port setting is executed after the initialization of clock setting.

### 9.2. Sample program main operation

This sample program executes the reset setting, the timer initialization, the LED initialization, and the Push switch setting initialization.  
After each initialization completes, CG function changes the operating mode according to the following conditions.

Operation in the Normal mode (LED: Blink on PB4)  
Change to a Low power mode by the Push switch.

LED On (PB4 to PB7) shows the operating mode (4 modes). The operating mode in the sample program can be checked by using the LED's.

When the operating mode is changed to a Low power mode by the Push switch, the following operations are executed.

The mode timeout is set according to RTC alarm setting condition (1 minute in this sampling program).

After the alarm setting interval elapses, the operating mode is changed to the Normal mode by the alarm interrupt.

The direct transition between Low power modes is invalid in this sample program. The transition should be done via the Normal mode.

\* The RTC function executes the calendar initialization (Sunday, January 01, 2017 00:00:00) and sets the alarm time.

The alarm time can be set for a day, a date, an hour, and a minute

### 9.3. Operating Mode Switching

The mode switching can be done by setting the GND level selectively to the PORT pins (PN1 to PN3) in this sample program.

After power is supplied or the reset is deasserted, the microcontroller enters the Normal state.

The low power mode is switched to the Normal mode after the RTC alarm setting interrupt is executed.

The interval of the RTC alarm interrupt has been set to 1 minute in this sample program.

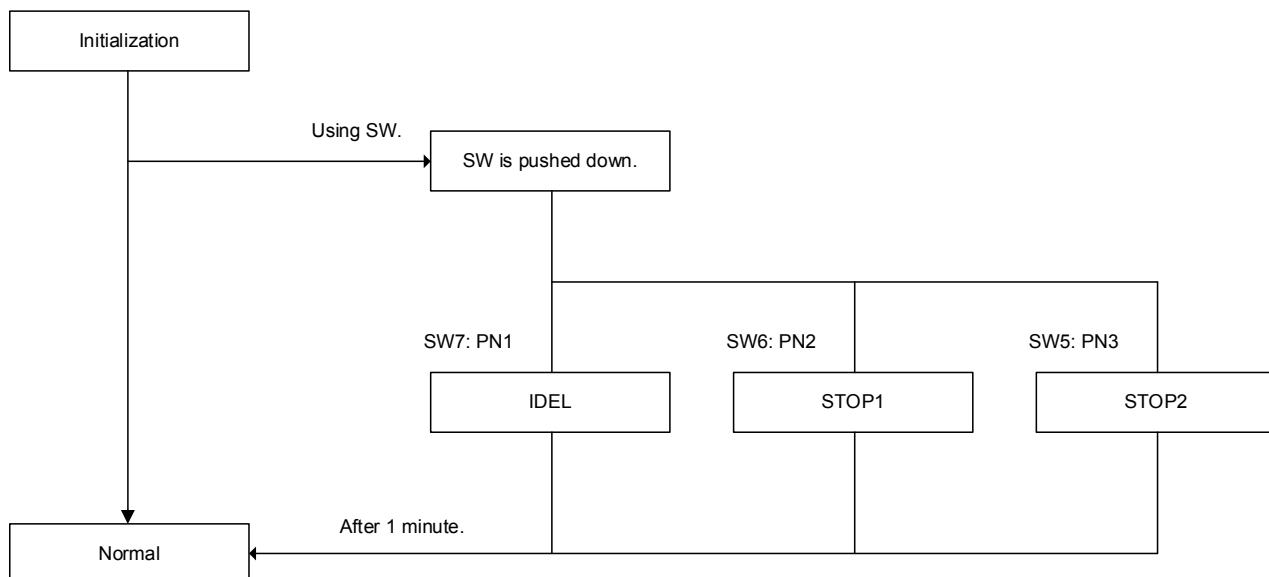

## 9.4. Operating Flow of Sample Program

The operating flows of the sample program are shown as follows.

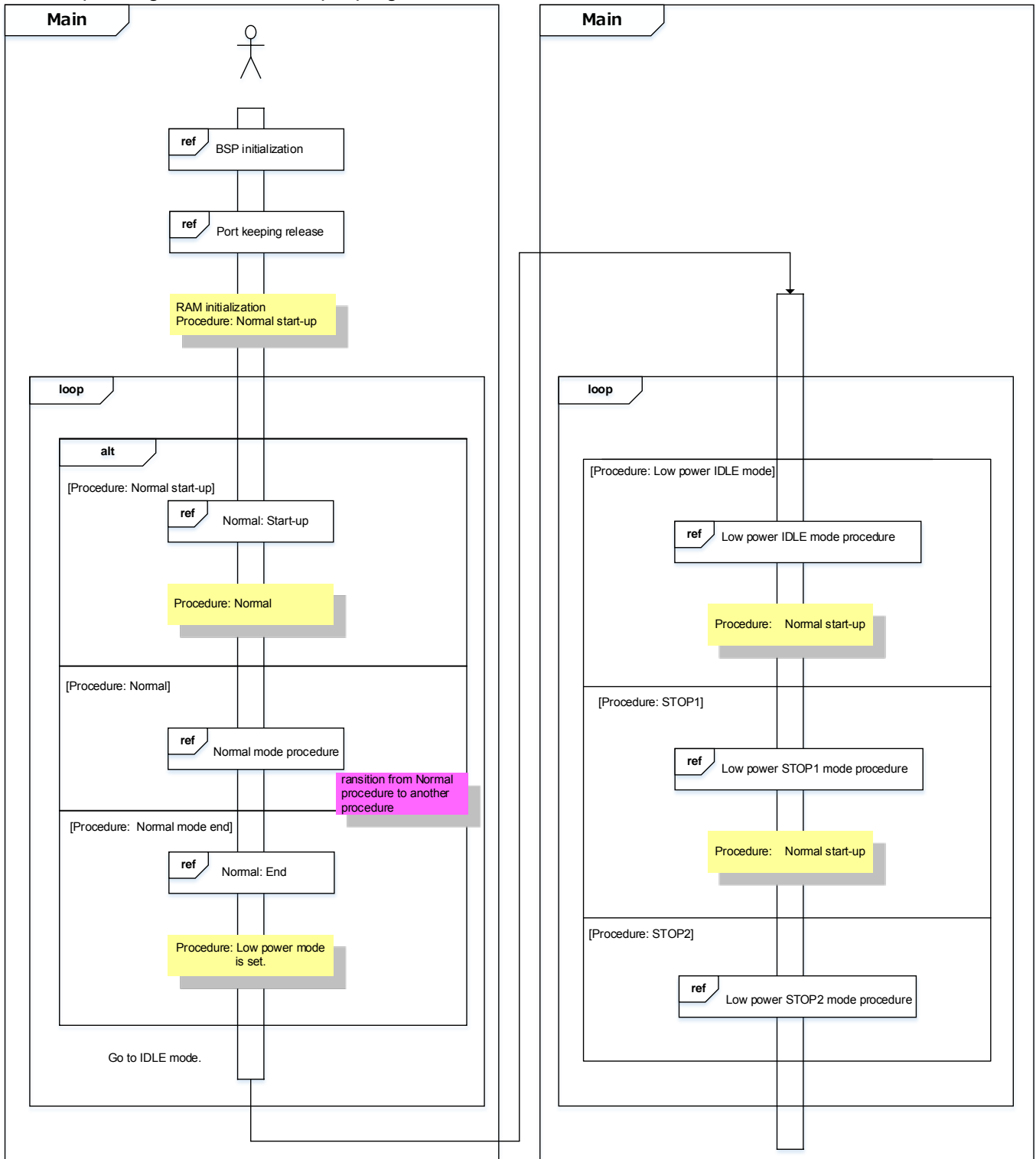

### Normal mode

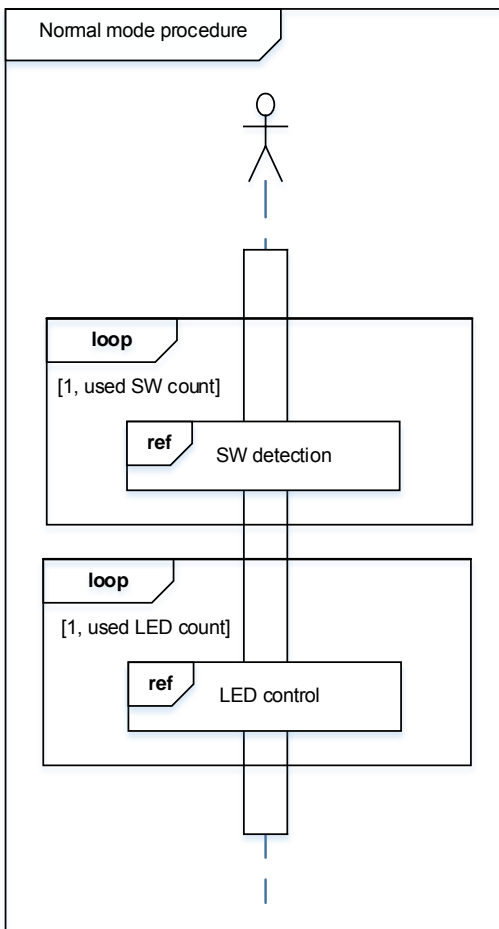
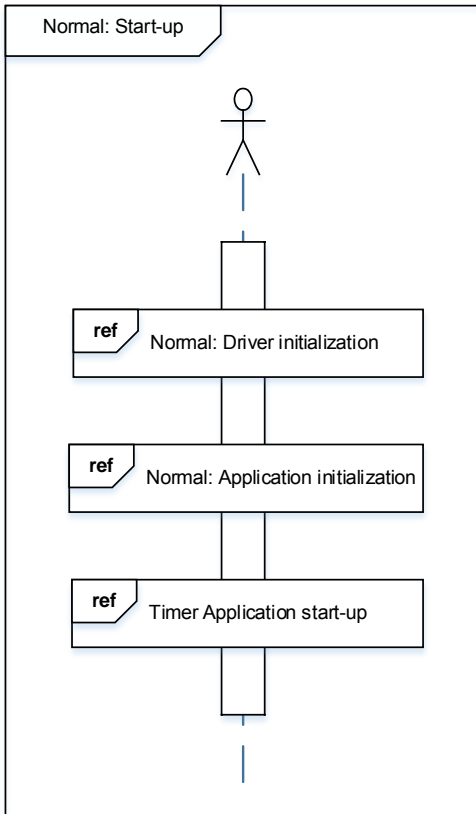

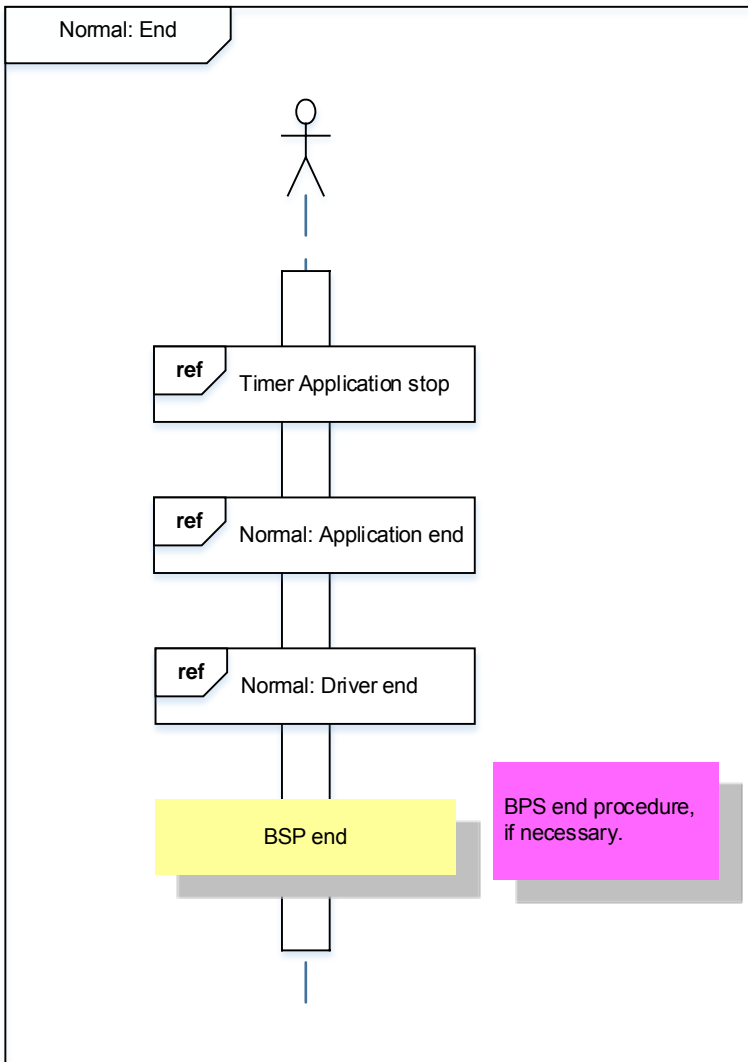

### IDLE mode

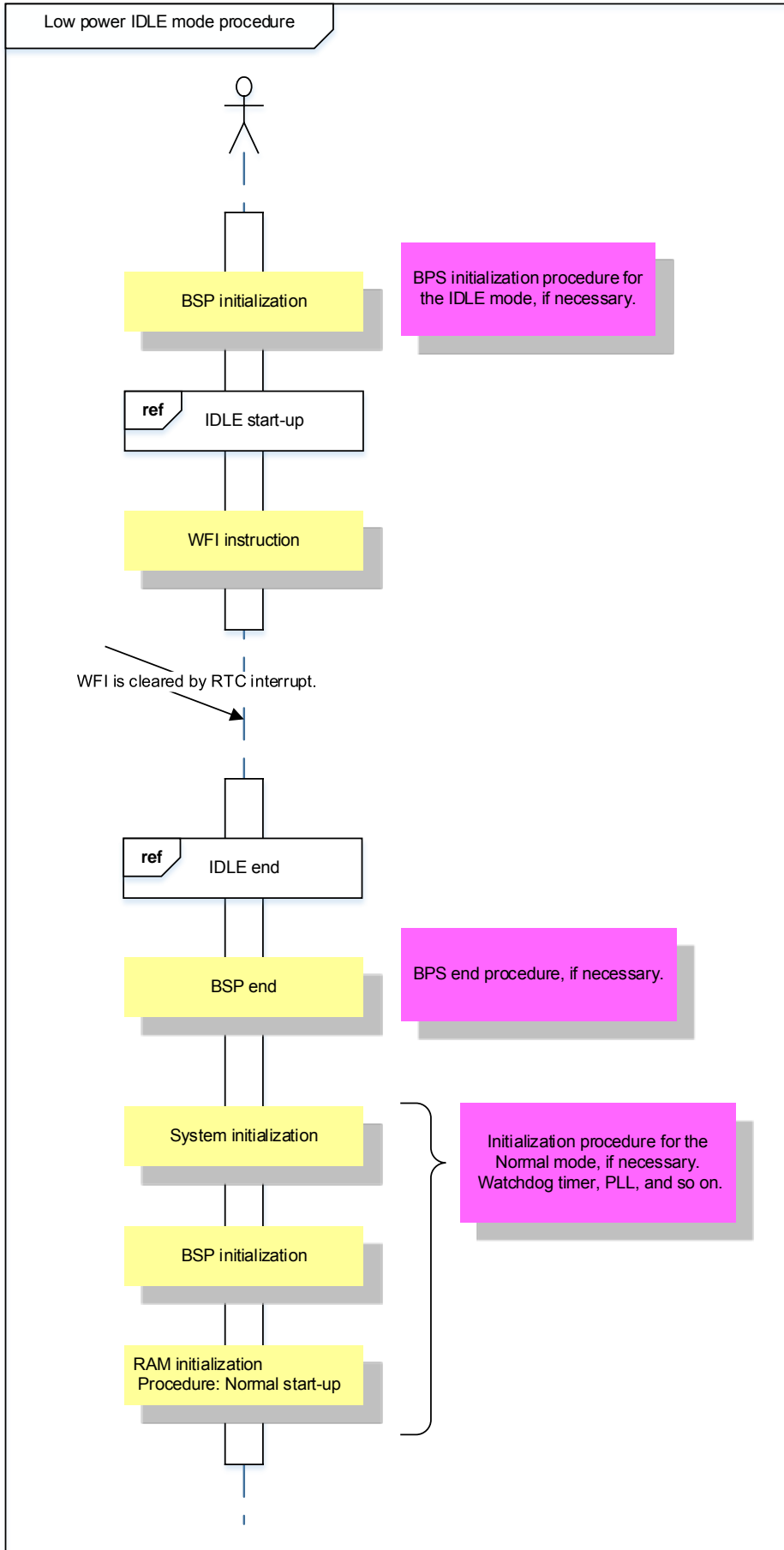

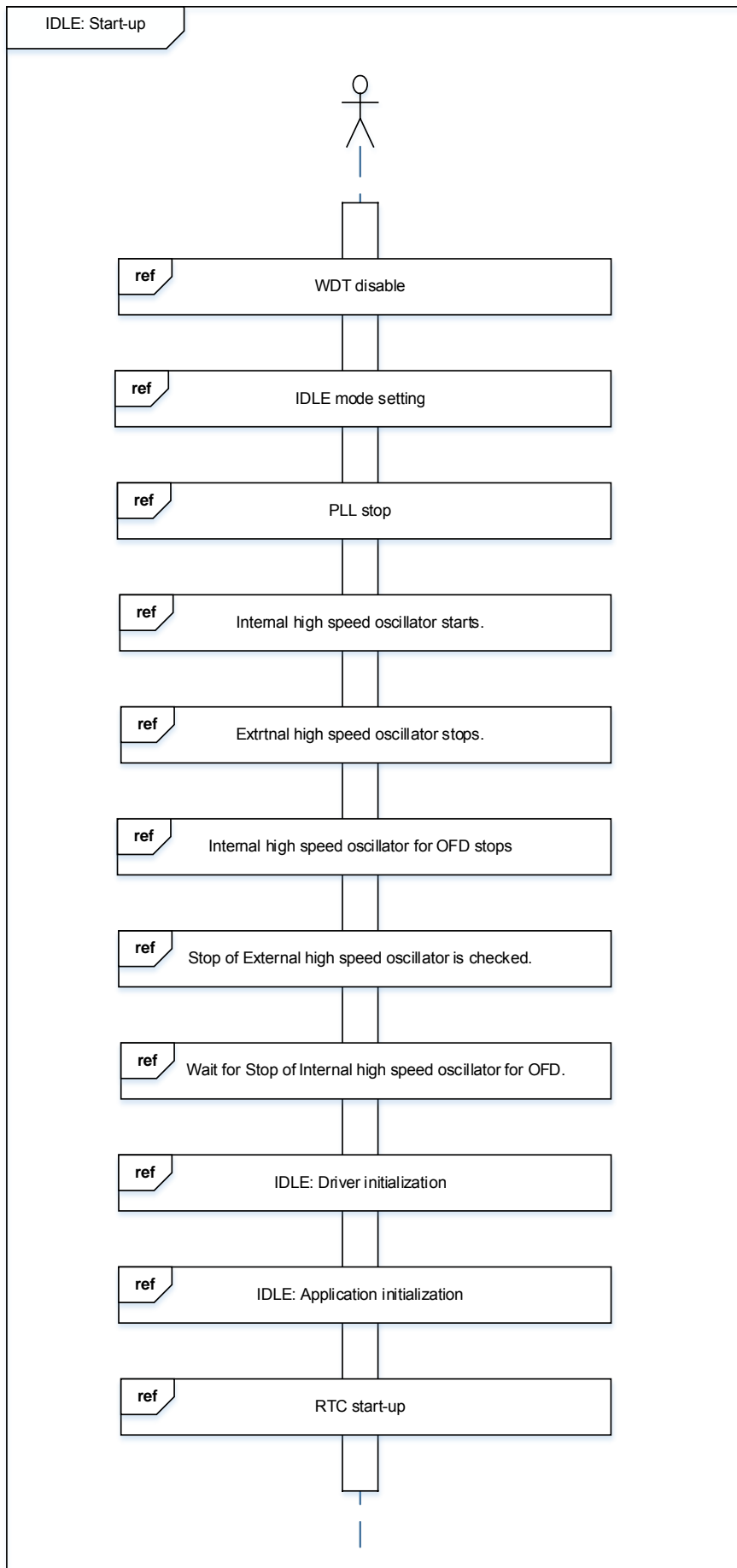

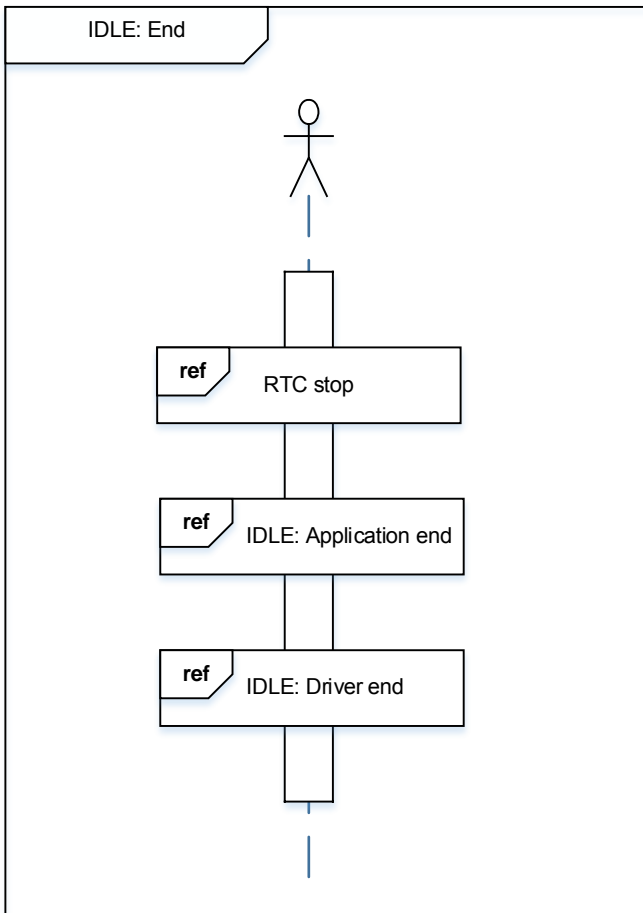

### STOP1 mode

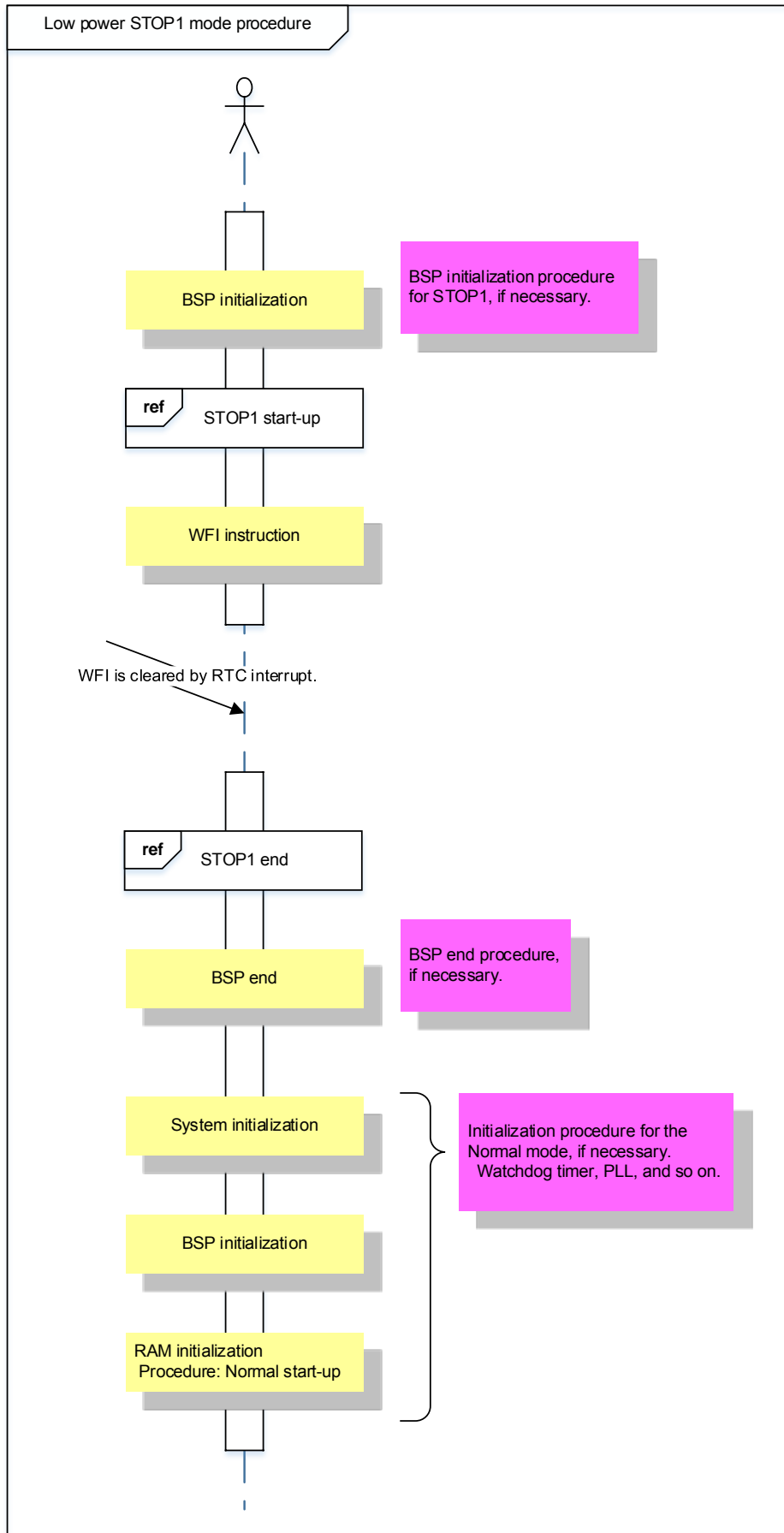



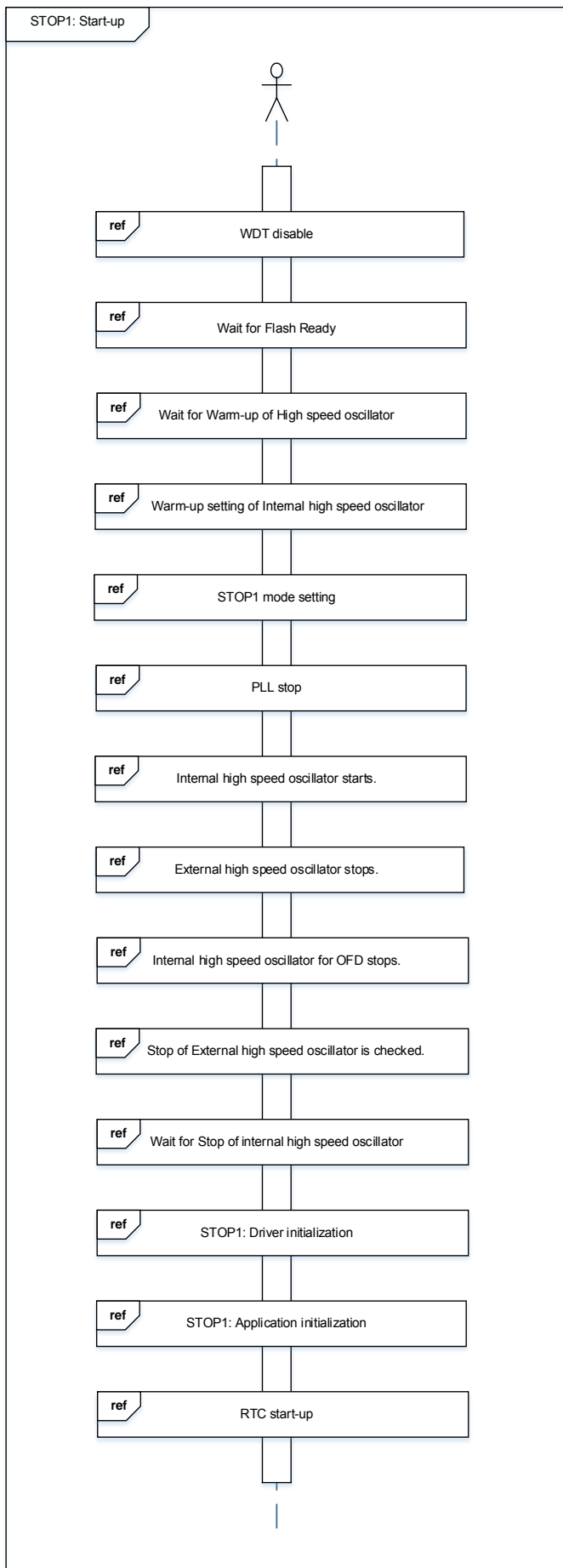

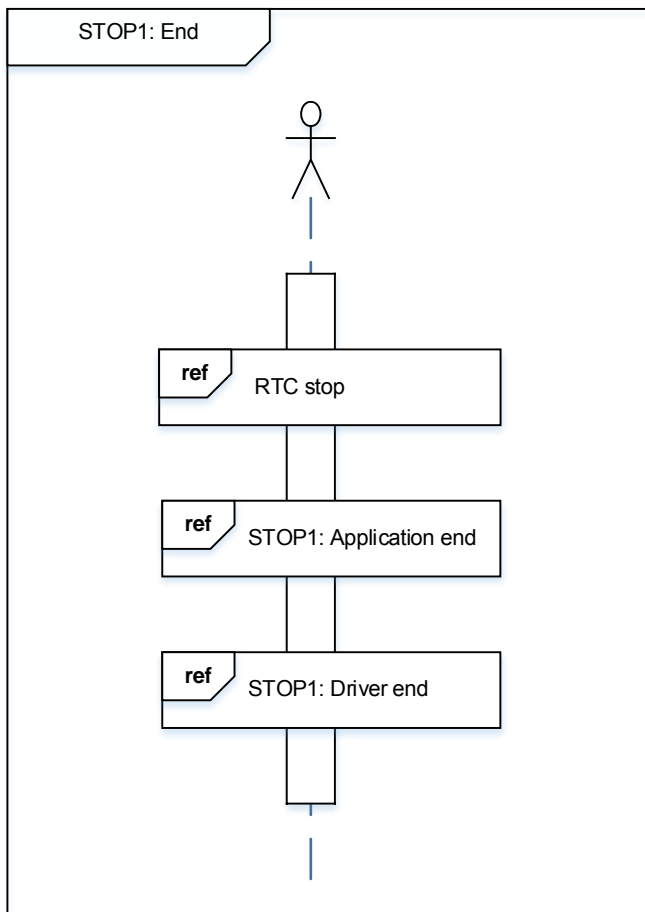

### STOP2 mode

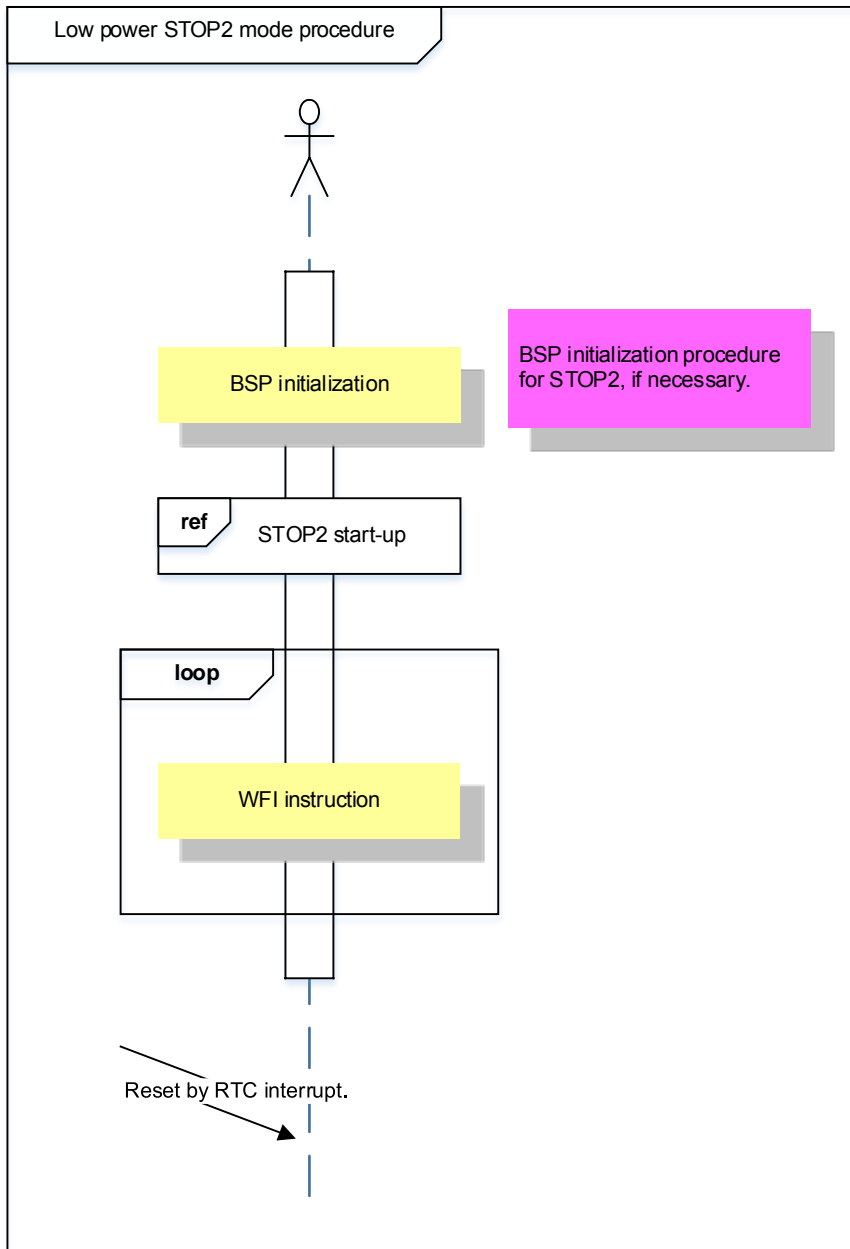

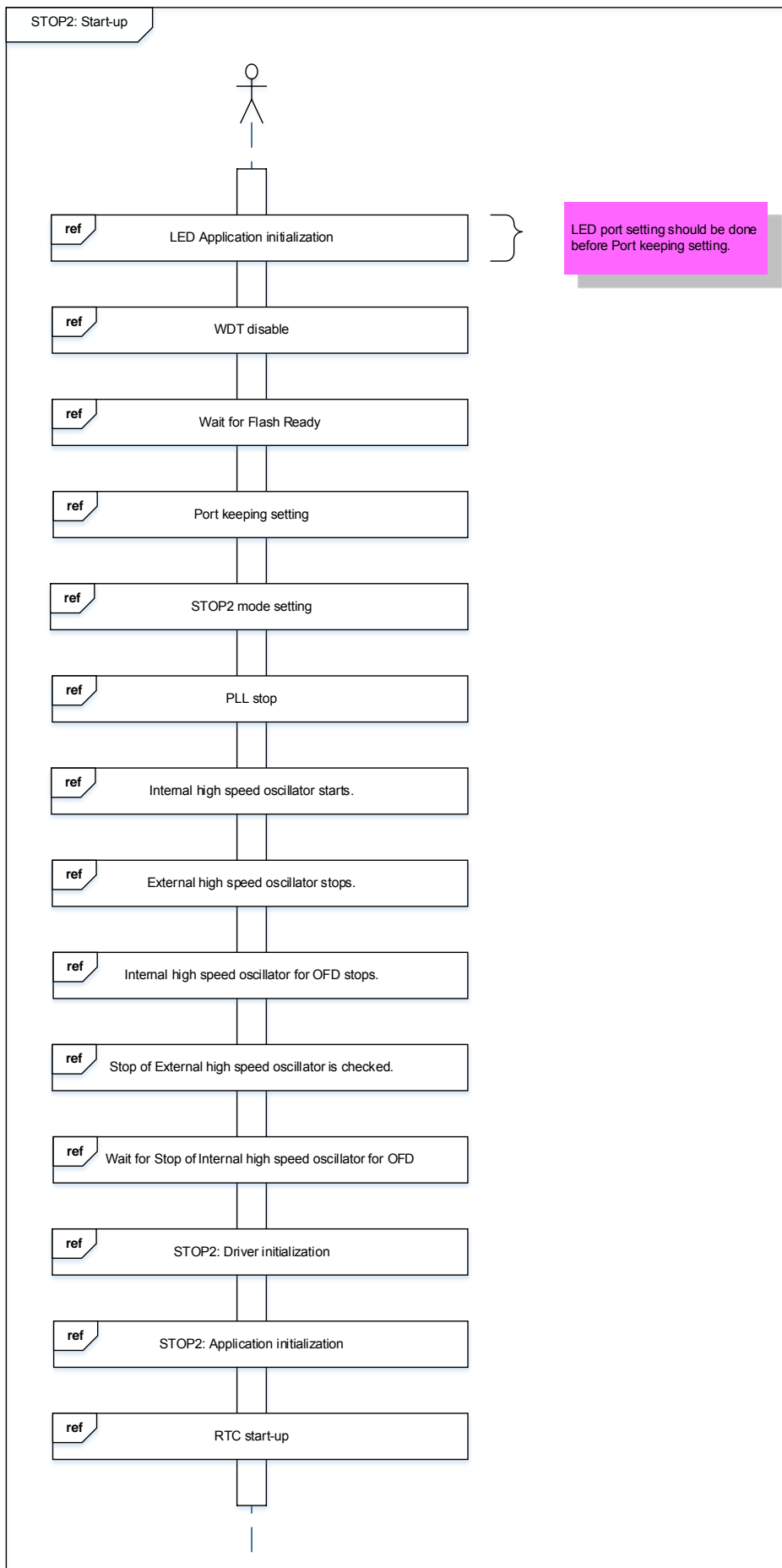

## 10. Precaution

When using the sample program with CPU other than TMPM3H6, please check operation sufficiently.

## 11. Revision History

Rev	Date	Page	Description
1.0	2018-03-22	–	First release

## RESTRICTIONS ON PRODUCT USE

Toshiba Corporation and its subsidiaries and affiliates are collectively referred to as "TOSHIBA". Hardware, software and systems described in this document are collectively referred to as "Product".

- TOSHIBA reserves the right to make changes to the information in this document and related Product without notice.
- This document and any information herein may not be reproduced without prior written permission from TOSHIBA. Even with TOSHIBA's written permission, reproduction is permissible only if reproduction is without alteration/omission.
- Though TOSHIBA works continually to improve Product's quality and reliability, Product can malfunction or fail. Customers are responsible for complying with safety standards and for providing adequate designs and safeguards for their hardware, software and systems which minimize risk and avoid situations in which a malfunction or failure of Product could cause loss of human life, bodily injury or damage to property, including data loss or corruption. Before customers use the Product, create designs including the Product, or incorporate the Product into their own applications, customers must also refer to and comply with (a) the latest versions of all relevant TOSHIBA information, including without limitation, this document, the specifications, the data sheets and application notes for Product and the precautions and conditions set forth in the "TOSHIBA Semiconductor Reliability Handbook" and (b) the instructions for the application with which the Product will be used with or for. Customers are solely responsible for all aspects of their own product design or applications, including but not limited to (a) determining the appropriateness of the use of this Product in such design or applications; (b) evaluating and determining the applicability of any information contained in this document, or in charts, diagrams, programs, algorithms, sample application circuits, or any other referenced documents; and (c) validating all operating parameters for such designs and applications. **TOSHIBA ASSUMES NO LIABILITY FOR CUSTOMERS' PRODUCT DESIGN OR APPLICATIONS.**
- **PRODUCT IS NEITHER INTENDED NOR WARRANTED FOR USE IN EQUIPMENTS OR SYSTEMS THAT REQUIRE EXTRAORDINARILY HIGH LEVELS OF QUALITY AND/OR RELIABILITY, AND/OR A MALFUNCTION OR FAILURE OF WHICH MAY CAUSE LOSS OF HUMAN LIFE, BODILY INJURY, SERIOUS PROPERTY DAMAGE AND/OR SERIOUS PUBLIC IMPACT ("UNINTENDED USE").** Except for specific applications as expressly stated in this document, Unintended Use includes, without limitation, equipment used in nuclear facilities, equipment used in the aerospace industry, medical equipment, equipment used for automobiles, trains, ships and other transportation, traffic signaling equipment, equipment used to control combustions or explosions, safety devices, elevators and escalators, devices related to electric power, and equipment used in finance-related fields. **IF YOU USE PRODUCT FOR UNINTENDED USE, TOSHIBA ASSUMES NO LIABILITY FOR PRODUCT.** For details, please contact your TOSHIBA sales representative.
- Product shall not be used for or incorporated into any products or systems whose manufacture, use, or sale is prohibited under any applicable laws or regulations.
- The information contained herein is presented only as guidance for Product use. No responsibility is assumed by TOSHIBA for any infringement of patents or any other intellectual property rights of third parties that may result from the use of Product. No license to any intellectual property right is granted by this document, whether express or implied, by estoppel or otherwise.
- **ABSENT A WRITTEN SIGNED AGREEMENT, EXCEPT AS PROVIDED IN THE RELEVANT TERMS AND CONDITIONS OF SALE FOR PRODUCT, AND TO THE MAXIMUM EXTENT ALLOWABLE BY LAW, TOSHIBA (1) ASSUMES NO LIABILITY WHATSOEVER, INCLUDING WITHOUT LIMITATION, INDIRECT, CONSEQUENTIAL, SPECIAL, OR INCIDENTAL DAMAGES OR LOSS, INCLUDING WITHOUT LIMITATION, LOSS OF PROFITS, LOSS OF OPPORTUNITIES, BUSINESS INTERRUPTION AND LOSS OF DATA, AND (2) DISCLAIMS ANY AND ALL EXPRESS OR IMPLIED WARRANTIES AND CONDITIONS RELATED TO SALE, USE OF PRODUCT, OR INFORMATION, INCLUDING WARRANTIES OR CONDITIONS OF MERCHANTABILITY, FITNESS FOR A PARTICULAR PURPOSE, ACCURACY OF INFORMATION, OR NONINFRINGEMENT.**
- Do not use or otherwise make available Product or related software or technology for any military purposes, including without limitation, for the design, development, use, stockpiling or manufacturing of nuclear, chemical, or biological weapons or missile technology products (mass destruction weapons). Product and related software and technology may be controlled under the applicable export laws and regulations including, without limitation, the Japanese Foreign Exchange and Foreign Trade Law and the U.S. Export Administration Regulations. Export and re-export of Product or related software or technology are strictly prohibited except in compliance with all applicable export laws and regulations.
- Please contact your TOSHIBA sales representative for details as to environmental matters such as the RoHS compatibility of Product. Please use Product in compliance with all applicable laws and regulations that regulate the inclusion or use of controlled substances, including without limitation, the EU RoHS Directive. **TOSHIBA ASSUMES NO LIABILITY FOR DAMAGES OR LOSSES OCCURRING AS A RESULT OF NONCOMPLIANCE WITH APPLICABLE LAWS AND REGULATIONS.**