

Photocouplers and Photorelays

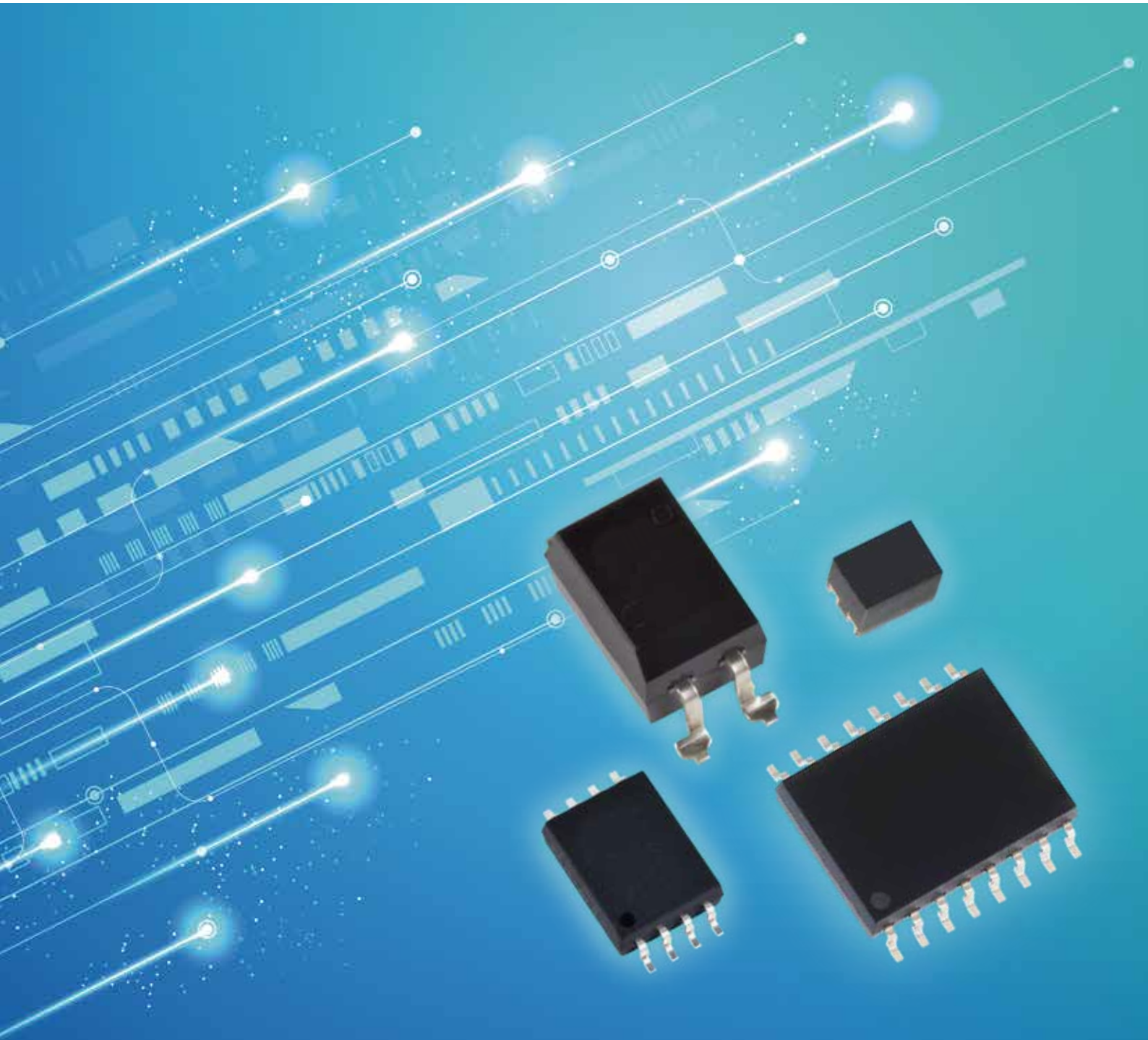

Photocouplers are widely used in various electronic devices to isolate high-speed signals from noise-sensitive circuits. Toshiba's photocouplers consist of a high-intensity infrared light-emitting diode (LED) optically coupled to a photodetector fabricated using the latest process. The LED-photodetector couple is encapsulated in an electrically insulating resin with high transparency. Features of Toshiba's photocouplers include certification to many international safety standards, high isolation and low power consumption. They are suitable for applications requiring a high level of safety.

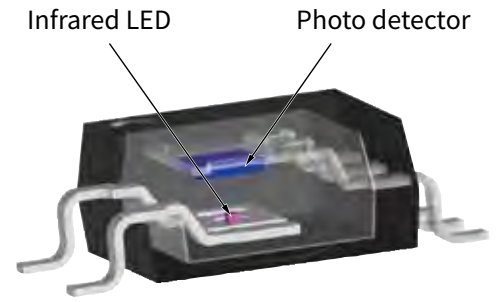

Features of Toshiba's Photocouplers

High
Reliability

- High-power infrared LEDs
- Extended temperature range of up to 125°C
- Long-life LED

Toshiba has developed new high-power infrared LEDs with a multi-quantum-well (MQW) structure, which are being incorporated into various types of photocouplers. The new LEDs exhibit only a 15% reduction in the light output after 100,000 hours of continuous operation, compared with a 50% degradation of the conventional LEDs.

※ MQW (Multiple Quantum Well)

Estimated LED Aging Degradation (\bar{X} -3 σ)

Energy
Saving

- Low LED input current
- Low power consumption
- Low noise

Toshiba offers an extensive portfolio of photocouplers that operate with a low input current on the order of 1 mA. This is achieved by using a high power LED. These photocouplers can be driven directly by a microcontroller without any buffers and thus help reduce the system power consumption.

* As of June 2016 (as surveyed by Toshiba)

Thin flat
Package

- Small, thin packages
- Packages with a long creepage distance
- Reinforced insulation

Small, thin SO packages can be mounted on the backside of a printed circuit board with a strict height limit. Placing photocouplers on the backside of a PCB reduces the number of parts mounted on the top side, making it possible to reduce the board size and improve the design flexibility.

Lineup

Both photocouplers and photorelays consist of a light-emitting element and a light-receiving element in the same package. Their input and output signals are optically coupled with each other to provide electrical isolation. Photocouplers and photorelays are available with many output types to meet various interface needs. Major applications of photocouplers and photorelays are divided into signal transmission and switching. Toshiba offers photocouplers and photorelays with various types of output interface.

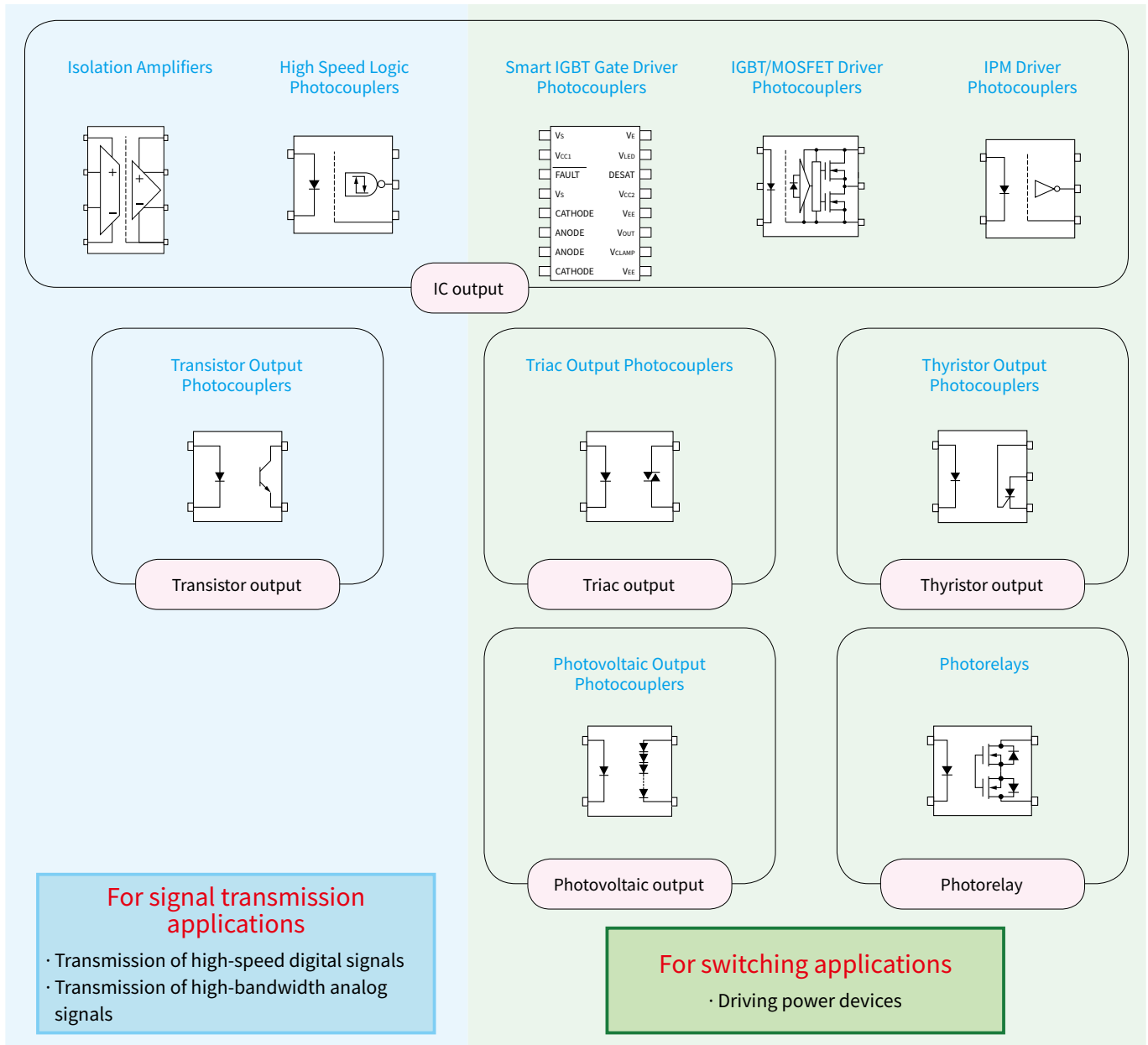

Contents

Features of Toshiba's Photocouplers	2	Package	25
Lineup	3	Safety Standards	30
— Product Information —		Part Naming Conventions	32
Isolation Amplifiers / Delta-Sigma Modulators	4	— Product Table —	
Smart IGBT Gate Driver Photocouplers	6	Selection Guide	34
High-Speed Logic Photocouplers	8	Part Number Index / Safety Standards	51
IPM Driver Photocouplers	10	Package Lineup	56
IGBT/MOSFET Driver Photocouplers	12	Package	
Triac Output Photocouplers /		Package Dimensions and Land Pattern Examples	57
Thyristor Output Photocouplers	14	Rank Marking	65
Transistor-Output Photocouplers	16	Packing	
Photovoltaic Output Photocouplers	18	Magazine Packing Specification	67
Photocouplers for Automotive	19	Tape-and-Reel Specification	69
Photorelays	20	Projected Operating Life of Photocouplers	71

Isolation Amplifiers / Isolated Delta-Sigma Modulators

Toshiba offers optically coupled isolation amplifiers that incorporate a high-precision delta-sigma AD converter on the input side. These isolation amplifiers are suitable for high-precision current and voltage sensing in servo-motor and inverter applications.

High-precision, high-efficiency operation is required for industrial applications, including servo amplifiers and inverters. In these applications, it is necessary to monitor changes in a motor phase current or an inverter bus voltage and provide feedback to a microcontroller. To meet this requirement, Toshiba's optically coupled isolation amplifiers incorporate a delta-sigma AD converter with a high linearity on the input side.

Isolation amplifiers with analog and digital outputs are available; thus you can select isolation amplifiers that suit your application needs.

Features

1. Industry's highest level of linearity

Due to the use of a high-precision delta-sigma AD converter, Toshiba's isolation amplifiers with an analog output provide a nonlinearity of 0.02% (typical), and those with a digital output have a nonlinearity of 4 LSB* (typical).

*: 1LSB = 9.765625 μ V

2. Significant reduction in power consumption

Toshiba's isolation amplifiers incorporate a unique digital modulation/demodulation technology that considerably reduces the dependence of the primary-side supply current on the input voltage, leading to a reduction in the maximum circuit current. (Roughly 67% that of an isolation amplifier from competitor)

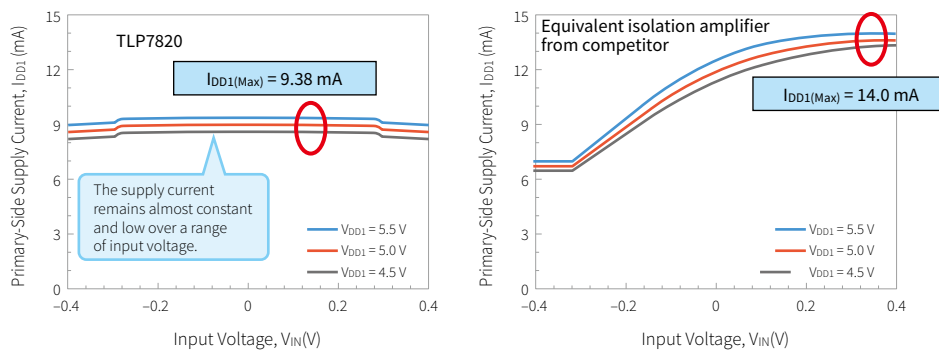

Primary-Side Circuit Current vs. Input Voltage

3. Common-mode transient immunity of 20 kV/ μ s

Due to a common-mode transient immunity (CMTI) of 20 kV/ μ s (typical), Toshiba's isolation amplifiers are also stable even in electrically noisy motor control environments.

4. Thin SO8L package

Toshiba offers an isolation amplifier in the thin SO8L package with a height of 2.3 mm (maximum), which is thinner than the package for a comparable isolation amplifier from competitor. The use of the SO8L package helps reduce the system size.

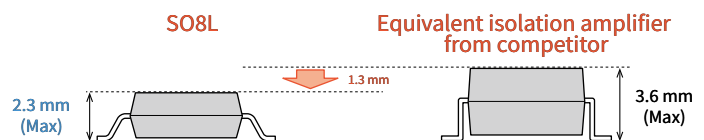

Comparison of the Package Height

Application Example for Isolation Amplifiers (Inverter Circuit)

To achieve high-precision control, an inverter contains several isolation amplifiers for the following purposes:

- 1. Motor phase current detection:** High-precision sensing of a phase current to precisely control the motor torque
- 2. Inverter bus voltage detection:** High-precision sensing of the changes in the inverter bus voltage (DC)
- 3. Overcurrent detection:** Detection of overcurrent conditions of IGBTs or other motor drivers to protect a motor

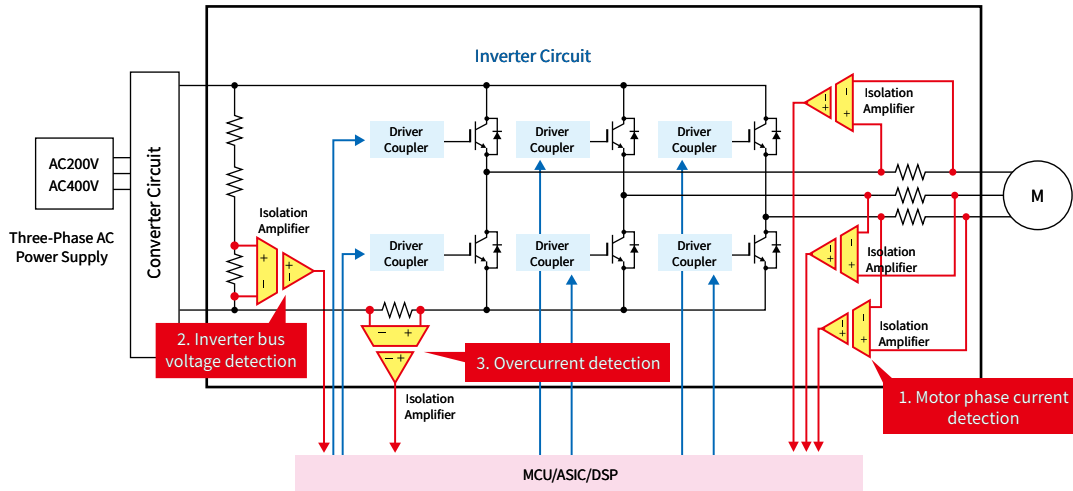

Selection Table

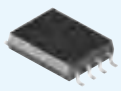
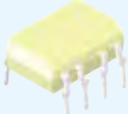
Creepage / Clearance (mm)	8.0	7.0	8.0
Isolation Voltage (V _{rms})	5000	5000	5000
Package	SO8(LF4)	DIP8	
			
Output Configuration			(Type F)
Analog Output	TLP7820	TLP7920	TLP7920F
Digital Output	TLP7830	TLP7930	TLP7930F

Gain Rank

Analog-output isolation amplifiers are available with the following gain ranks:

Gain Rank	Gain
None	± 3%
A	± 1%
B	± 0.5%

Analog- and Digital-Output Isolation Amplifiers

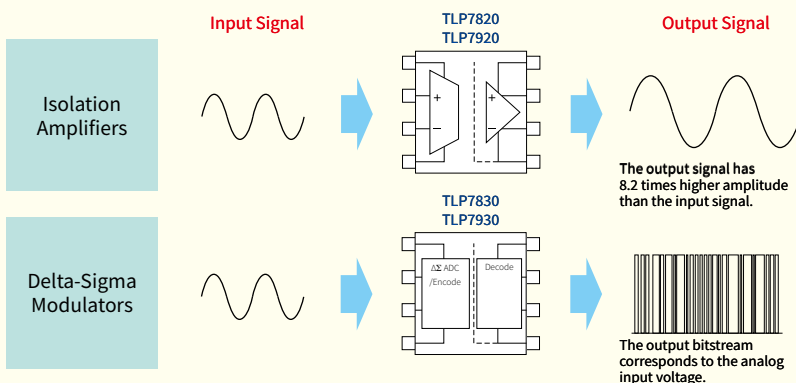

- The delta-sigma AD converter on the primary side converts the analog input voltage into digital data, which are optically transmitted by an LED to the output side.
- On the secondary side, a photodiode receives the digital data, which are converted to an analog signal by a DA converter.

- The process of analog input signal is same as Isolation Amplifiers.
- The secondary side provides a data bitstream and a clock.

Smart Gate Driver Photocouplers

Insulated smart IGBT gate driver photocouplers are enhanced versions of general-purpose gate driver photocouplers that incorporate various protection features, an active Miller clamp, and a fault output function, combining high performance and low cost.

The integrated protection features for the gate drive of a power device help improve the system safety, cut design time, and reduce the circuit footprint.

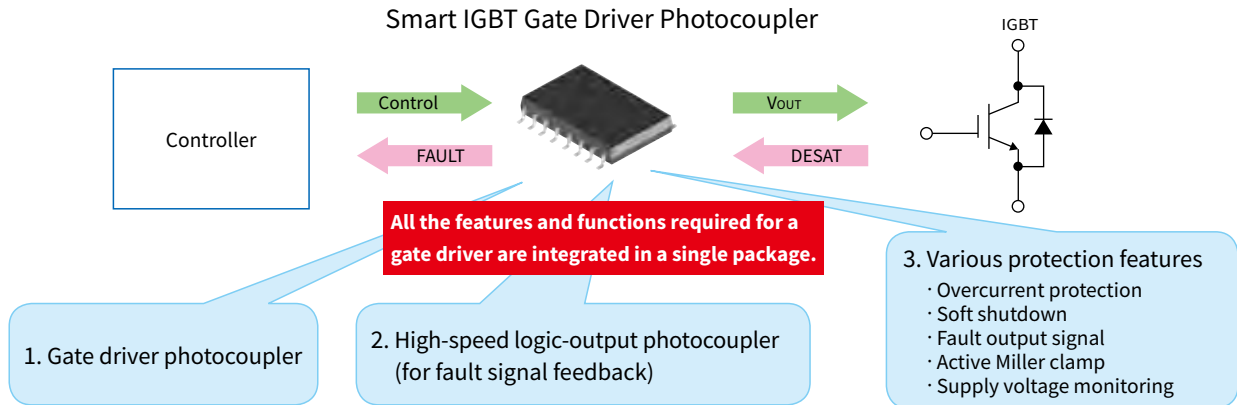

► Features

1. Overcurrent Protection

The overcurrent protection feature available with Toshiba’s smart IGBT gate driver photocouplers senses an excessive current flowing in the circuit and protects it against permanent damage. For example, if an excessive current flows into an IGBT in an inverter circuit, its collector-emitter voltage (V_{CE}) increases, leading to permanent damage of the IGBT due to excessive power. In order to prevent device destruction, it is necessary to cut off the excessive current as soon as possible.

There are several techniques for overcurrent protection. Of these techniques, monitoring the collector-emitter saturation voltage, $V_{CE(sat)}$, of IGBTs has several advantages, including a low power loss and a protection operation that does not require a microcontroller or a controller, which make high-speed operation possible. These photocouplers are suitable to drive power devices whose short-circuit ruggedness is decreasing because of shrinking process geometries.

Toshiba’s smart IGBT gate driver photocouplers incorporate a soft shutdown function, which constantly monitors the collector-emitter saturation voltage and slowly turns off IGBTs in the event of an overcurrent condition. At the same time, smart IGBT gate driver photocouplers send a fault signal to a controller.

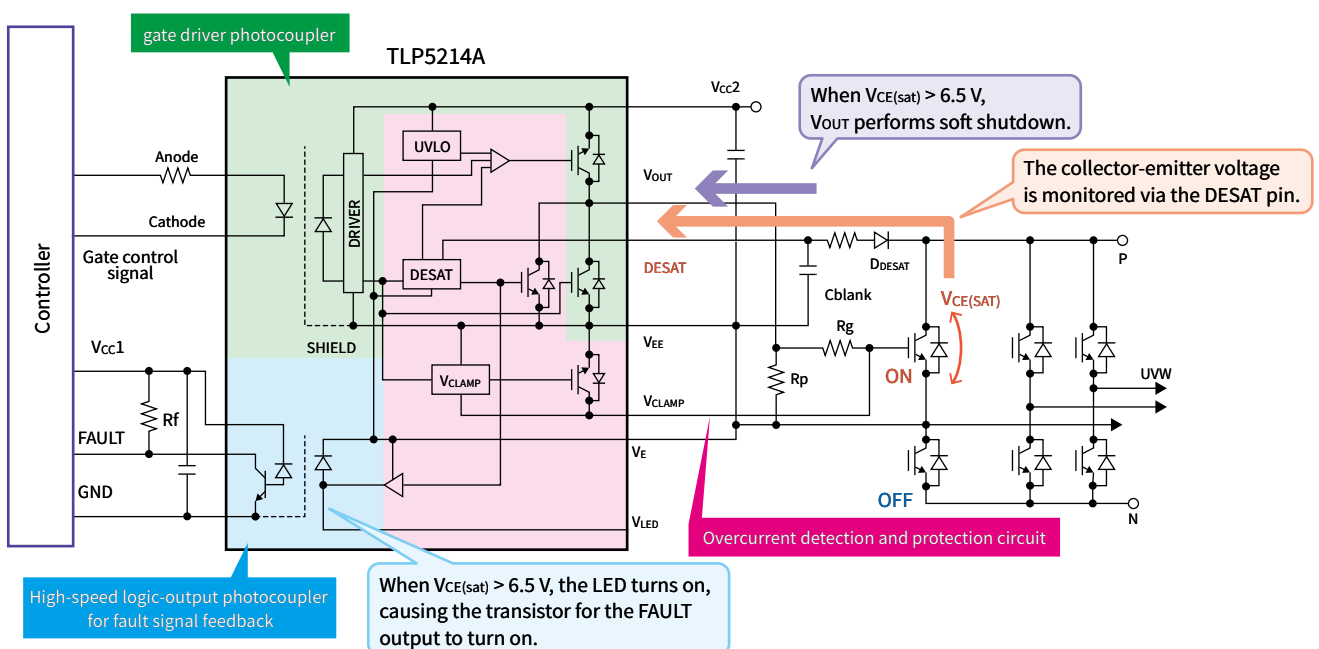

2. Active Miller Clamp

An inverter might malfunction when a switching noise falsely turns on an IGBT owing to the parasitic Miller capacitance (C_{CG}) between the collector and gate. A false turn-on of an IGBT might cause a large current to flow because of a short-circuit between the upper and lower arms, leading to the destruction of the IGBT. A protection circuit composed of external components is complicated and requires large board space.

To address this problem, Toshiba's smart IGBT gate driver photocouplers incorporate a circuit that bypasses a Miller current to GND in order to prevent a false turn-on of the IGBT due to an increase in the gate voltage. This feature is called an active Miller clamp.

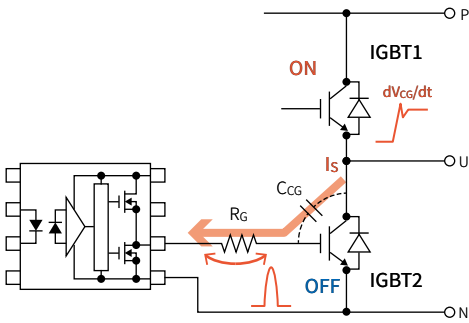

False IGBT turn-on due to Miller capacitance

1. When IGBT1 turns on, the voltage at U increases sharply.
2. A Miller current, I_s , flows through the Miller capacitance (C_{CG}) of IGBT2. When it flows through the gate resistor (R_G), a voltage drop occurs across R_G , causing the gate voltage to increase.
3. Due to a rise in the gate voltage, IGBT2 falsely turns on. With both IGBT1 and IGBT2 being on, a short circuit occurs between them.

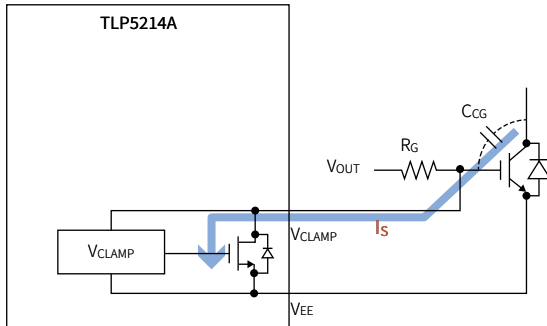

Operation of the active Miller clamp

1. The Miller clamp pin (V_{CLAMP}) is connected to the gate of an IGBT.
2. When a High-to-Low transition of the photocoupler output (V_{OUT}) causes the gate voltage to drop below roughly 3 V, the MOSFET between V_{CLAMP} and V_{EE} integrated in the photocoupler turns on.
3. This IGBT bypasses the Miller current (I_s) from the V_{CLAMP} pin to the emitter, reducing a rise in the gate voltage. This prevents a short-circuit between upper- and low-arm IGBTs.

■ Selection Table

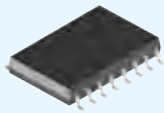
Creepage / Clearance (mm)		8.0
Isolation Voltage (V_{rms})		5000
Package		SO16L 
Peak Output Current I_{OP}	Propagation Delay Time t_{pHL} (Max)	
4.0 A	150 ns	TLP5214 TLP5214A
1.0 A	300 ns	TLP5231**

**: Under Development

Features						
Overcurrent detection	Soft shutdown	Fault output signal	Active Miller clamp	^{(*)1} Undervoltage lockout (UVLO)	^{(*)2} Rail-to-rail output	Dual-output
✓	✓	✓	✓	✓	✓	
✓	✓	✓		✓	✓	✓

*1 Undervoltage lockout: A feature for holding the output at the Low level until the supply voltage reaches a prescribed level.

*2 Rail-to-rail output: An output whose voltage swings almost to the supply voltage.

High-Speed Logic Photocouplers

High-speed logic photocouplers incorporate a photosensor to transfer a signal at high speed between two isolated circuits. Whereas transistor-output photocouplers provide signal transmission at up to tens of kbps, high-speed logic photocouplers are capable of data transmission at up to 50 Mbps.

Toshiba offers high-speed logic photocouplers compliant with a wide range of communication standards such as medium-speed RS-232, and high-speed RS-485 and factory networks. Featuring reinforced insulation compliant with international safety standards, high noise immunity, and a low input drive current on the order of 1 mA, these photocouplers enhance the safety of an end application and provide an energy-efficient solution.

	Analog-Output Photocouplers				Digital-Output Photocouplers		
	Transistor-Output	Medium-Speed IC-Output		High-Speed IC-Output			
Data rate	A few kbps	Up to 20 kbps	Up to 300 kbps	Up to 1 Mbps	Up to 5 Mbps	Up to 20 Mbps	Up to 50 Mbps
Communication standard	—	RS-232	RS-232C	Factory CAN network	I ² C, SPI	RS-422/RS-485	Factory networks
Typical part	TLP385	TLP2701	TLP2703	TLP2719	TLP2710	TLP2768A	TLP2767
Internal schematic							
Propagation delay time (Max)	Not guaranteed	30 μs	10 μs	1 μs	0.25 μs	0.06 μs	0.02 μs

* Usable photocouplers depend on actual operating conditions (frequency, ambient temperature, etc).

Toshiba's Photocouplers Compliant with Major Communication Standards

▶ Medium-Speed Photocouplers (20 to 300 kbps)

Generally, transistor-output photocouplers for communication applications provide a data rate of up to a few kbps. It is difficult to achieve a faster data rate with a transistor-output photocoupler since its propagation delay time is not guaranteed. If you need a faster data rate, you need to use a high-speed IC-output photocoupler that provides a data rate of 1 Mbps or higher. To address the need for intermediate data rates, Toshiba offers low-cost medium-speed photocouplers with a data rate of 20 to 300 kbps. There is also demand for photocouplers that support an extended temperature range of up to 125°C. Toshiba's product portfolio contains photocouplers with an operating temperature range of up to 125°C.

Feature 1

Fills the need for medium speed

Photocouplers with a data rate from 20 to 300 kbps

Feature 2

Guaranteed maximum propagation delay time

Simplifies the design process due to the guaranteed maximum propagation delay time

Feature 3

High-temperature operation

High reliability with guaranteed operation at temperatures of up to 125°C

Feature 4

Low cost

Less costly than high-speed IC photocouplers with a data rate of 1 Mbps or higher

▶ High-Speed Photocouplers (1 to 50 Mbps)

In response to a market shift to low-voltage microcontrollers, Toshiba offers many photocouplers that can operate from 2.5-V*, 3.3-V and 5-V power supplies.

Since these photocouplers can be used in mixed 2.5*/3.3/5-V systems, you can use common parts across multiple system models. In addition, Toshiba offers photocouplers with an LED input threshold current of 2 mA or less and those with reinforced insulation.

Feature 1

2.5*/3.3/5-V power supplies

Directly interfaces with low-voltage microcontrollers

Feature 2

Low LED drive current

Can be directly driven from an output current port of a microcontroller

Feature 3

Small, thin packages

Can be mounted on the backside of a board and thus increases the flexibility in board design

Feature 4















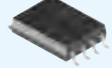























































Reinforced insulation



























Photocouplers in the double-molded SO6 package provide clearance and creepage distances of 5 mm whereas those in the double-molded SO6L package provide clearance and creepage distances of 8 mm.



*: New Product (TLP2312, TLP2372A)

Selection Table

























2.5V / 3.3V / 5V Operating

Creepage / Clearance (mm)			5	8	5	8	8	4	4.2	8	
Isolation Voltage (V _{rms})			3750	5000	3750	5000		3750	2500	5000	
Features			Package			SO6L		SO8		SO8L (LF4)	
Data Rate (bit/s)	Output Form										
						(LF4)		1ch	2ch	2ch	
20 k	OC	INV	TLP2301 	TLP2701 							
100 k	OC	INV			TLP2303 	TLP2703 					
300 k	OC	INV						TLP2403			
1 M	OC	INV			TLP109 	TLP2719*	TLP2719 (LF4)*	TLP2409 			
5 M	TP	BUF			TLP2310  	TLP2710  	TLP2710 (LF4)*  		TLP2110  	TLP2210* 	
					TLP2312*  						
					TLP2355  						
					TLP2395  						
10 M	TP	INV			TLP2358  						
					TLP2398  						
					TLP2362  						
	OC	INV			TLP2363*  						
15 M	TP	INV			TLP2391  						
					TLP2361  	TLP2761  	TLP2761 (LF4)*  		TLP2161  	TLP2261  	
20 M	TP	BUF			TLP2368  	TLP2768A  	TLP2768A (LF4)*  	TLP2468 	TLP2168 		
					TLP2370  	TLP2770  				TLP2270  	
					TLP2372*  						
50 M	TP	INV			TLP2366  	TLP2766A*	TLP2766A (LF4)*	TLP2466 	TLP2160 		
					TLP2367  	TLP2767  					

Creepage / Clearance (mm)			7	8	7	8	7	8
Isolation Voltage (V _{rms})			5000	5000	2500 / 5000	5000	5000	5000
Features			Package				SDIP6	
Data Rate (bit/s)	Output Form							
			1ch	(Type F)	2ch	(Type F)	(Type F)	(Type F)
1 M	OC	INV	TLP759	TLP759F	TLP2530 TLP2531		TLP719	TLP719F
5 M	TP	BUF	TLP2955  	TLP2955F  				
		INV	TLP2958  	TLP2958F  				
10 M	OC	INV			TLP2662  	TLP2662F  		
15 M	OC	INV	TLP2962  	TLP2962F  				
20 M	TP	INV					TLP2768  	TLP2768F  
		INV					TLP2766  	TLP2766F  

 : Operating ambient temperature range of up to 125°C
 : Maximum input threshold current (I_{FLH}/I_{FHL}) of 2 mA or less
 OC: Open Collector Output
 TP: Totem Pole Output
 INV: Inverter Logic Output
 BUF: Buffer Logic Output
 *: New Product

5V Operating

Creepage / Clearance (mm)			5	8	8	4	4.2	7	7	8
Isolation Voltage (V _{rms})			3750	5000		3750	2500	5000	5000	5000
Features			Package			SO8		DIP8	SDIP6	
Data Rate (bit/s)	Output Form									
				(LF4)		1ch	2ch		(Type F)	
1 M	OC	INV	TLP2304*	TLP2704	TLP2704 (LF4)*	TLP2404				
5 M	TP	BUF				TLP2405  	TLP2105  		TLP715	TLP715F
		INV				TLP2408  	TLP2108  		TLP718	TLP718F
10 M	TP	BUF	TLP2345  	TLP2745  	TLP2745 (LF4)*			TLPN137		
		INV	TLP2348  	TLP2748  	TLP2748 (LF4)*					
15 M	OC	INV				TLP2418  	TLP2118E			
20 M	TP	INV	TLP118  							
		INV	TLP116A							

IPM Interface Photocouplers

IPM interface photocouplers are suitable for isolated interfacing to an intelligent power module (IPM). They support a wide range of gate power supply. These photocouplers provide excellent common-mode transient immunity to prevent false operation in an electrically noisy environment.

IPM interface photocouplers are available in both **open-collector** and **totem-pole output** configurations. In addition, IPM interface photocouplers with a totem-pole output are available with an inverting or noninverting output. Therefore, you can find optimal photocouplers that best fit your needs, regardless of the active input level of the driven IPM.



Features

1. Photocouplers with low input current

Toshiba offers many photocouplers with an input threshold current of 1.6 mA or less that can be directly driven from an output current port of a microcontroller without a buffer.

In addition, photocouplers with a totem-pole output eliminate the need for an external pullup resistor.

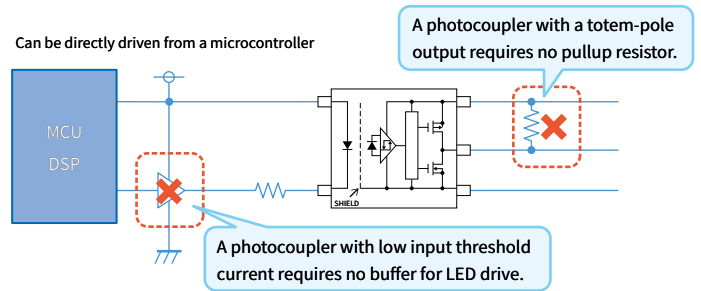

2. High-speed photocouplers

Since IPM interface photocoupler transfer a PWM signal, they must switch fast enough, generally with propagation delay times (t_{pHL}/t_{pLH}) of less than 800 ns. Toshiba offers high-speed photocouplers with a propagation delay of 800 ns or less and those with a propagation delay of 100 ns or less. Toshiba also offers photocouplers that guarantee a propagation delay skew (between multiple devices), t_{psk} , of at most ± 60 ns, which helps improve the PWM signal transmission accuracy.

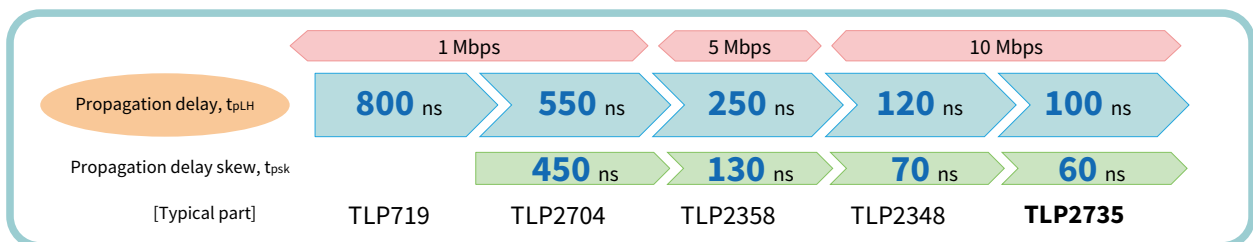



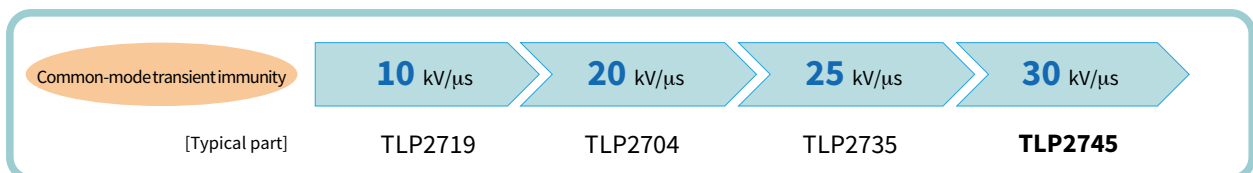
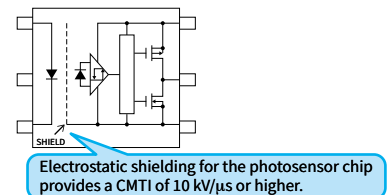

3. High common-mode transient immunity

Generally, a common-mode transient immunity (CMTI) higher than 10 kV/ μ s is required for photocouplers for IPM applications since a sharp voltage difference occurs between the input and output sides. Toshiba's IPM interface photocoupler incorporate an electrostatic shield for the photosensor chip to provide a CMTI higher than 10 kV/ μ s.

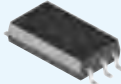

Selection Table

Creepage / Clearance (mm)				5	8		4	4.2	7	8	7	8	
Isolation Voltage (Vrms)				3750	5000	5000	3750	2500	5000	5000	5000	5000	
Features				Package		SO8		SDIP6		DIP8			
Propagation delay time (Max)		Output Form											
				(LF4)		1ch		2ch		(F type)		(F type)	
1 M bps	800 ns	OC	Analog	TLP2309	TLP2719*	TLP2719 (LF4)*	TLP2409		TLP719	TLP719F	TLP759	TLP759F	
	550 ns	OC	Digital	TLP2304* H	TLP2704 H	TLP2704 (LF4)* H	TLP2404 H		TLP714 H	TLP714F H	TLP754 H	TLP754F H	
5 M bps	250 ns	TP	BUF	TLP2355 H L TLP2395 H			TLP2405 L	TLP2105 L	TLP715	TLP715F	TLP2955 H L	TLP2955F H L	
			INV	TLP2358 H L TLP2398 H			TLP2408 L	TLP2108 L	TLP718	TLP718F	TLP2958 H L	TLP2958F H L	
10 M bps	120 ns	TP	BUF	TLP2345 L	TLP2745 L	TLP2745 (LF4)* L							
			INV	TLP2348	TLP2748 L	TLP2748 (LF4)* L							
	100 ns	TP	BUF		TLP2735* H								
	75 ns	OC	INV								TLP2662 H	TLP2662F H	
15 M bps	80 ns	TP	INV	TLP2361 H L									
	75 ns	OC	INV				TLP2418 H				TLP2962 H	TLP2962F H	

TP: Totem Pole Output

INV: Inverter Logic Output

*: New Product

OC: Open Collector Output

BUF: Buffer Logic Output

H: Operating ambient temperature range of up to 125°C

L: Maximum input threshold current (I_{FLH}/I_{FHL}) of 1.6 mA or less

Active-Low and active-High IPMs

Commercially available IPMs have either an **active-High control input** (that turns on an internal IGBT when High) or an **active-Low control input** (that turns on an internal IGBT when Low). Toshiba offers IPM driver photocouplers with a **buffer logic output** (that produce a High output when the LED input is on) for active-High IPMs and those with an **inverter logic output** (that produce a Low output when the LED input is on) for active-Low IPMs. You can use photocouplers with an appropriate output configuration to adapt system boards according to the input logic of an IPM without an intervening inverter IC. The elimination of an on-board inverter IC makes it possible to share the same board design across different product models.

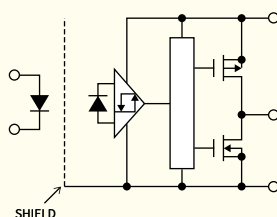

Active-High IPM

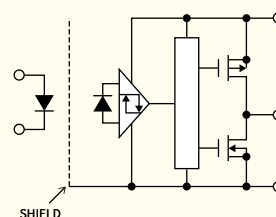

Active-Low IPM

IGBT/MOSFET Gate Driver Photocouplers

Toshiba offers photocouplers suitable for IGBT/MOSFET gate drive. Toshiba's photocouplers guarantee a high common-mode transient immunity, making them suitable for industrial applications such as inverters and servos that will be installed in electrically noisy environments.

Toshiba's photocoupler portfolio includes an extensive lineup of photocouplers with an output current ranging from 0.6 A to the industry's highest, 6.0 A. Thus, you can select photocouplers that best fit your needs according to the gate capacitances of the driven IGBTs and MOSFETs.

Features

1. High output current and low supply current

Due to the output stage fabricated using a BiCD process*, **the TLP358H** combines an output current as high as 6.0 A with a low supply current of at most 2.0 mA. The TLP358H can directly drive a 1200 V/200 A-class IGBT due to a peak output current of 6.0 A.

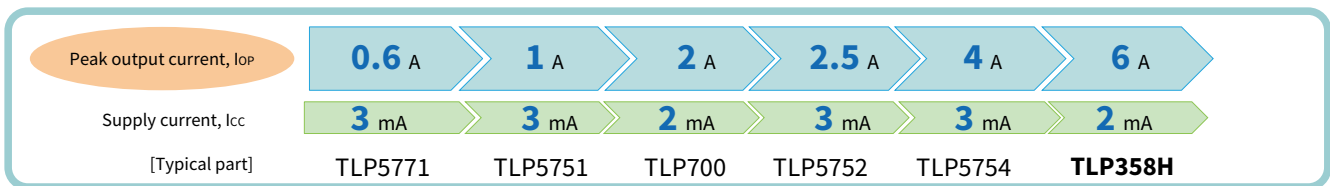

* BiCD stands for Bipolar-CMOS-DMOS. BiCD is a CMOS-based hybrid process that integrates LDMOS and bipolar transistors.
LDMOS: Lateral Double diffused MOS (Metal Oxide Semiconductor)

2. Rail-to-rail output

The output voltage of typical IGBT/MOSFET gate driver photocouplers becomes lower than the supply voltage by a few volts. To address this problem, Toshiba offers photocouplers with a rail-to-rail output, which swings almost between GND and V_{CC} . The rail-to-rail output helps reduce the switching loss of the photocoupler while reducing the gate supply voltage or increasing a design margin.

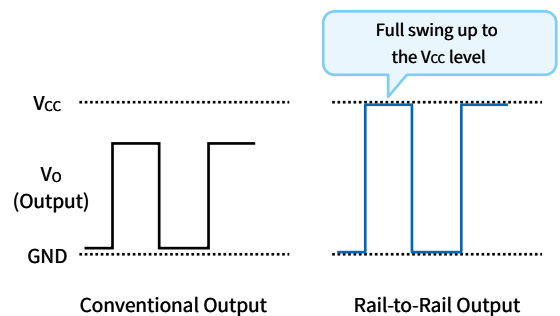

3. Undervoltage lockout (UVLO)

Most of Toshiba's IGBT/MOSFET driver photocouplers incorporate a UVLO feature, which prevents the power device from excessive heating caused by a drop in gate voltage due to an unusual condition. UVLO holds the output Low until the supply voltage exceeds the rising UVLO threshold, making it possible to guarantee a saturated, low-on-resistance operation of a power device.



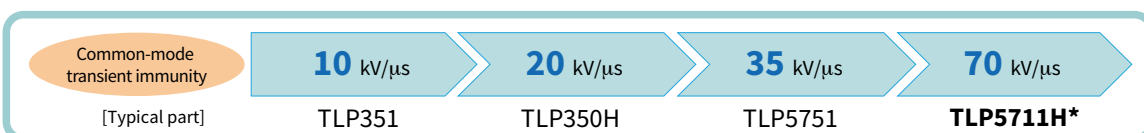

4. High common-mode transient immunity

An inverter circuit might malfunction if a voltage with a steep dV/dt is applied across the input and output of a photocoupler. The common-mode transient immunity of a photocoupler can be improved by adding an electrostatic shield between its input and output to bypass a displacement current to GND.

To provide a sufficient common-mode transient immunity for direct IGBT/MOSFET gate drive, Toshiba's IGBT/MOSFET gate driver photocouplers incorporate a shield for the photosensor chip. In particular, the **TLP5711H*** with a common-mode transient immunity as high as 70 $kV/\mu s$ can be used for industrial applications such as inverters and servos that will be exposed to an electrically noisy environment.

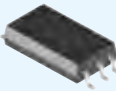

Selection Table

Creepage / Clearance (mm)		5.0	8.0	8.0	4.0	8.0	7.0	8.0	7.0	8.0	
Isolation Voltage (V_{rms})		3750	5000	5000	3750	5000	5000	5000	3750	3750	
Features		Package									
		5pin SO6		SO6L		SO8		SO8L		SDIP6	
											
				(LF4)				(Type F)		(Type F)	
I_{OP} (max)	t_{pLH} (max)										
0.6 A	700 ns							TLP701H	TLP701HF	TLP351H	TLP351HF
	500 ns	TLP151A	TLP5701	TLP5701(LF4)*	TLP2451A			TLP701A	TLP701AF	TLP351A	TLP351AF
	200 ns	TLP155E					TLP705A	TLP705AF			
1.0 A	150 ns			TLP5751	TLP5751(LF4)						
				TLP5771	TLP5771(LF4)*						
2 A / -1 A	380 ns			TLP5711H*							
2.5 A	500 ns							TLP700H	TLP700HF	TLP250H	TLP250HF
	200 ns			TLP5702	TLP5702(LF4)	TLP5832	TLP700A	TLP700AF	TLP352	TLP352F	
	190 ns	TLP152									
	150 ns			TLP5752	TLP5752(LF4)						
4.0 A	150 ns			TLP5772	TLP5772(LF4)*						
				TLP5774	TLP5774(LF4)*						
6.0 A	500 ns							TLP358	TLP358F	TLP358H	TLP358HF

H: Extended operating ambient temperature range of up to 125°C

*: New product

R: Rail-to-rail output

I_{OP} : Peak Output Current

U: Undervoltage lockout (UVLO)

t_{pLH}/t_{pHL} : Propagation Delay Time

Common-Mode Transient Immunity

In the event of a sharp voltage difference appearing across the input and output, a high-frequency noise due to a parasitic stray capacitance might propagate to the output, causing an instantaneous change in the photosensor output voltage. A photocoupler with a high common-mode transient immunity (CMTI) is less susceptible to malfunction in the presence of this noise. CMTI is defined as the maximum permissible change (dV/dt) in the common-mode voltage between the input and the output in order for a photocoupler to hold the prescribed High or Low level.

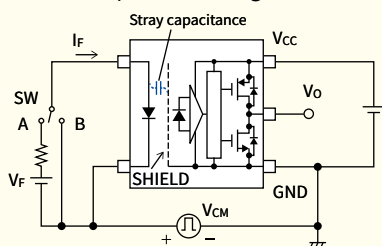

Common-mode transient immunity test circuit

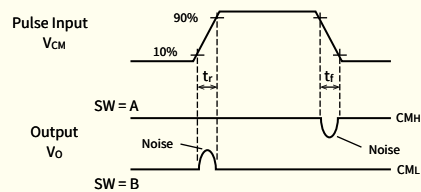

Input and Output Waveforms

Triac Output Photocouplers / Thyristor Output Photocouplers

Triac output photocouplers consist of an infrared light-emitting diode (LED) optically coupled with a triac, whereas thyristor output photocouplers consist of an infrared LED optically coupled with a thyristor. These photocouplers are suitable for controlling an AC load.

▶ Triac Output Photocouplers

Toshiba offers triac output photocouplers with a peak repetitive off-state voltage (V_{DRM}) of 600 V and 800 V. You can choose from non zero cross (NZC) triac output photocouplers that allow phase control of the triac and zero cross (ZC) triac output photocouplers that help reduce switching noise.

1. Low trigger LED current

Toshiba offers triac output photocouplers that can trigger the phototriac with a low LED current of 3 mA or less.

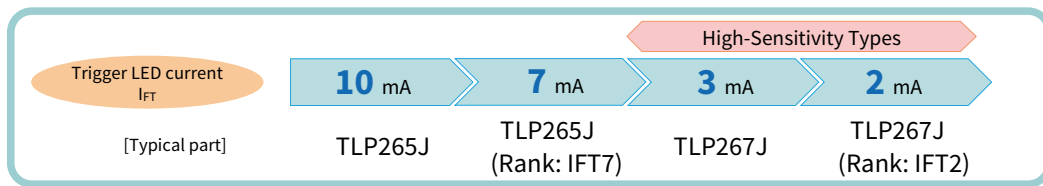

2. Reinforced insulation

The double-molded SO6 and DIP6 packages provide creepage and clearance distances of 5.0 to 8.0 mm and a distance through insulation of 0.4 mm, making them compliant with the reinforced insulation requirements of overseas safety standards.

■ Selection Table

Creepage / Clearance (mm)		5.0	4.0	7.0	8.0	7.0	8.0	7.0	8.0			
Isolation Voltage (V_{rms})		3750	2500	5000		5000		5000				
Features		Package	4pin SO6		4pin MFSOP6 (cut)	DIP4		5pin DIP6		5pin DIP6 (cut)		
		V_{DRM}	Output Type									
600 V	NZC		TLP265J [K] TLP267J [K] [L]		TLP360J	TLP360JF (Type F)	TLP3052A* [K]	TLP3052AF* [K]				
	ZC		TLP266J [K] TLP268J [K] [L]	TLP163J	TLP361J TLP363J	TLP361JF TLP363JF	TLP3062A* [K]	TLP3062AF* [K]	TLP3064(S) [L] TLP663J(S) [L] TLP668J(S) [L]	TLP3064F(S) [L] TLP663JF(S) [L] TLP668JF(S) [L]		
800 V	NZC						TLP3073* [K]	TLP3073F* [K]				
	ZC						TLP3083* [K] TLP669L(S) [L]	TLP3083F* [K] TLP669LF(S) [L]				

NZC: Non Zero Cross

ZC: Zero Cross

V_{DRM} (V): Off-state output terminal voltage

[K]: Reinforced insulation

[L]: Low trigger LED current ($I_{FT} \leq 3$ mA)

[Product for Japan]

*: New Product

Non Zero Cross (NZC) and Zero Cross (ZC) Triac Output Photocouplers

■ Non Zero Cross Type

In response to an input signal, NZC triac output photocouplers turn on immediately, making them suitable for phase control.

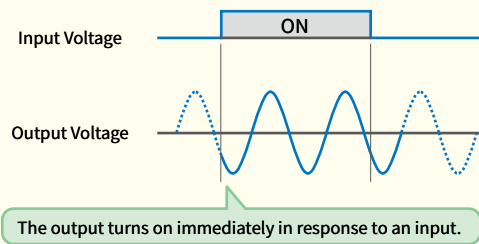
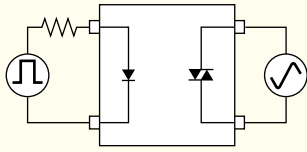

■ Zero Cross Type

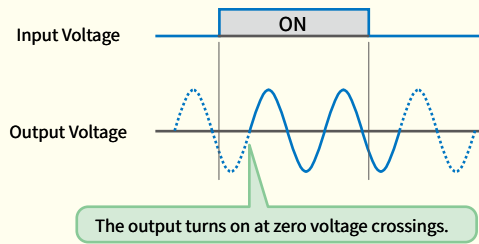
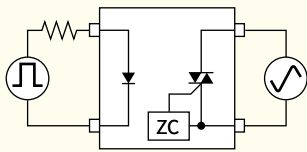

ZC triac output photocouplers turn on only when the output voltage is close to zero. Therefore, ZC triac output photocouplers emit little radio noise and help reduce inrush current.



► Thyristor Output Photocouplers

Thyristor output photocouplers are used to control AC loads that are directly connected to a 100VAC or 200VAC commercial power supply. An AC load of several tens of amperes can be controlled with a current of 10+ mA by using a thyristor output photocoupler in tandem with a power triac.

■ Selection Table

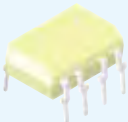
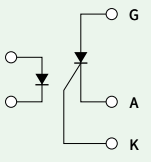
Creepage / Clearance (mm)		4.0	7.0	8.0	7.0
Isolation Voltage (V_{rms})		2500	2500 / 4000	4000	2500
Package		5pin MFSOP6	DIP6		7pin DIP8
Features					
V_{DRM}	Schematic			(Type F)	
400 V		TLP148G	TLP548J	TLP748J	TLP549J
600 V			TLP748J	TLP748JF	

V_{DRM} (V): Peak forward voltage

Transistor-Output Photocouplers

Transistor-output photocouplers, which have been manufactured since the early days of photocouplers, are most widely used in various applications due to their low prices and general versatility.

Transistor-output photocouplers are used for a wide range of applications such as voltage feedback in a power supply and optoelectronic interfacing in industrial equipment. Toshiba offers an extensive lineup of transistor-output photocouplers, including those with an operating ambient temperature range of up to 125°C and those with a high collector-emitter voltage (V_{CE0}) of 350 V.

Features

1. Current transfer ratio (CTR) at a low input current

Toshiba’s transistor-output photocouplers provide a high CTR even at a low input current of $I_F = 0.5 \text{ mA}$ due to the use of a high-power, long-life LED. Due to an equal CTR at $I_F = 5 \text{ mA}$ and $I_F = 0.5 \text{ mA}$, these photocouplers simplify functional design in the low-current region.

2. Expanded use of small, thin SO packages

Toshiba is focusing on migration from the conventional hole-through DIP packages to small, thin surface-mount SO packages. The new 4-pin SO6L package is 45% thinner than the conventional DIP4 package while providing creepage and clearance distances of 8 mm and an isolation voltage of 5000 Vrms equivalent to the DIP4 (Type F) package. Therefore, photocouplers in the SO6L package can be mounted on the backside of a printed circuit board with a strict height limit.

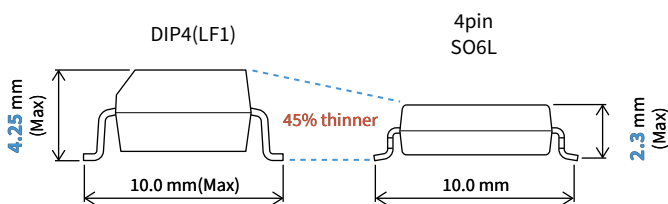
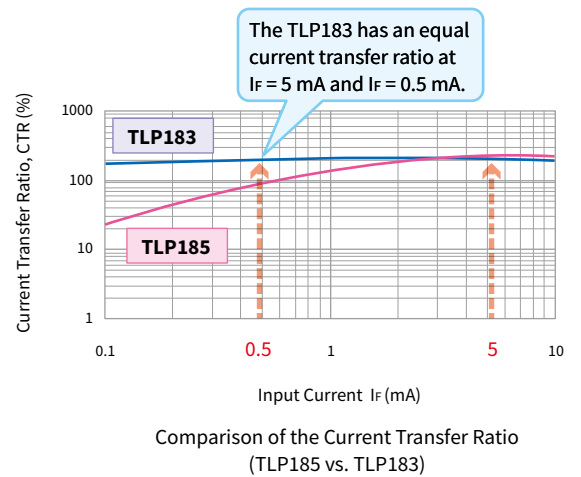

Comparison of the Package Height (DIP Package vs. SO6L Package)

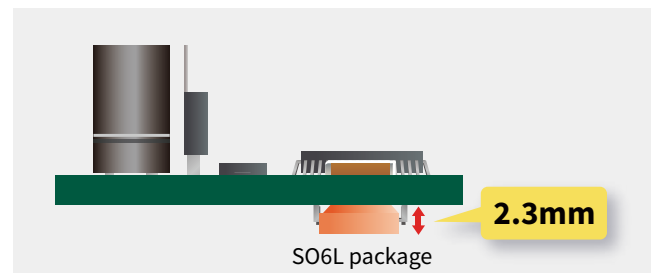

Mounting on the PCB Back Side

Current Transfer Ratio

The following figure shows a typical circuit using a transistor-output photocoupler. When LED current, I_F , is applied to the input side, the collector current, I_C , appears at the output side. The ratio of the collector current to the input LED current is specified as the current transfer ratio (CTR) and represented by the following equation. Photocouplers with a large current transfer ratio provide a large output current with a low input current.

As is the case with hFE for transistors, the current transfer ratio is an important parameter for transistor-output photocouplers.

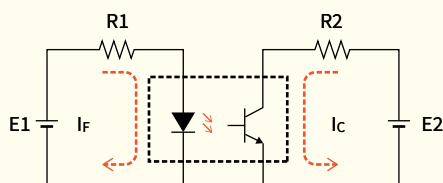





Circuit Configuration

$$CTR = \frac{I_C}{I_F} \times 100 (\%)$$

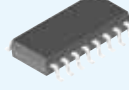
CTR

Selection Table

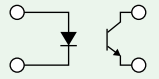
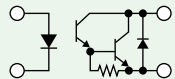
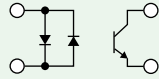
Creepage / Clearance (mm)			5.0	5.0	5.0	8.0	7.0	8.0	
Isolation Voltage (V _{rms})			3750	2500/3750	3750	5000	5000		
Features			Package						
									(Type F)
DC Input	 Single Transistor	General-purpose	TLP291(SE) ☆ 1 K	TLP291-4 ☆ 4	TLP185(SE) ☆ 1 K	TLP385 ☆ 1	TLP785 ☆ 1	TLP785F ☆ 1	
		Low Input Current <i>I_F</i> = 0.5 mA	TLP293 ☆ 1 H K Q	TLP293-4 ☆ 5 H K Q	TLP183 ☆ 1 H K Q	TLP383 ☆ 1 H K Q			
	 Darlington Transistor	High V _{CEO} V _{CEO} = 350 V			TLP188 ☆ 3 K Q	TLP388 ☆ 3 H K Q	TLP628M* ☆ 3 H K Q	TLP628MF* ☆ 3 H K Q	
		High V _{CEO} V _{CEO} = 300 V			TLP187 (Note 1) K Q	TLP387 (Note 1) K Q	TLP627M* K Q	TLP627MF* K Q	
AC Input	 Single Transistor	General-purpose	TLP290(SE) ☆ 2 K	TLP290-4 ☆ 4	TLP184(SE) ☆ 2 K				
		Low Input Current <i>I_F</i> = 0.5 mA	TLP292 ☆ 2 H K Q	TLP292-4 ☆ 5 H K Q	TLP182 ☆ 2 H K Q		TLP620M* ☆ 2 H K Q	TLP620MF* ☆ 2 H K Q	

Note 1: The TLP187 and TLP387 provide a guaranteed current transfer ratio (minimum) of 1000% (at *I_F* = 1 mA and V_{CE} = 1 V).

H: Extended operating ambient temperature range of up to 125°C

K: Reinforced insulation

Q: Incorporates a long-life

*: New product

Gain Rank

Different photocouplers are available with different CTR ranks.

Current Transfer Ratio Rank

Rank Name	CTR (%)		CTR (%)						Relevant Part				
	Min	Max	50	100	200	300	400	500	600	☆ 1	☆ 2	☆ 3	☆ 4
Blank	50	600	[50-600]						☆ 1	☆ 2	☆ 3		
	50	400	[50-400]										☆ 4
Y	50	150	[50-150]						☆ 1	☆ 2			
YH	75	150	[75-150]						☆ 1				
GR	100	300	[100-300]						☆ 1	☆ 2			
GRL	100	200	[100-200]						☆ 1				
GRH	150	300	[150-300]						☆ 1				
GB	100	600	[100-600]						☆ 1	☆ 2	☆ 3		
	100	400	[100-400]										☆ 4
BL	200	600	[200-600]						☆ 1	☆ 2			
BLL	200	400	[200-400]						☆ 1				
LA ^(Note 2)	50	600	[50-600]										☆ 5
LGB ^(Note 2)	100	600	[100-600]										☆ 5

Note 2: LA and LGB are CTR ranks in the low-input-current region.

Photovoltaic Output Photocouplers

In a photovoltaic output photocoupler, the light emitted by an LED is received by a photodiode array (PDA), which converts it into a voltage to drive the gate of a MOSFET or an IGBT. A gate driving circuit can be composed without an external power supply for the output side.

The photovoltaic output photocoupler has a similar configuration to the photorelay except that the former does not have a MOSFET on the output side. The photovoltaic output photocoupler allows you to select an arbitrary MOSFET to control voltage and current levels higher than those achievable with a photorelay.

In addition to general-purpose photovoltaic output photocouplers that require an external shunt resistor, Toshiba offers photocouplers with an internal shunt resistor and those with a discharge circuit.

Operation of the Photovoltaic Output Photocoupler

1. A voltage is applied to the input.
2. The red LED lights up.
3. The photodiode array receives the light from the LED and generates electricity.
4. The photodiode array drives a MOSFET with the generated electricity.

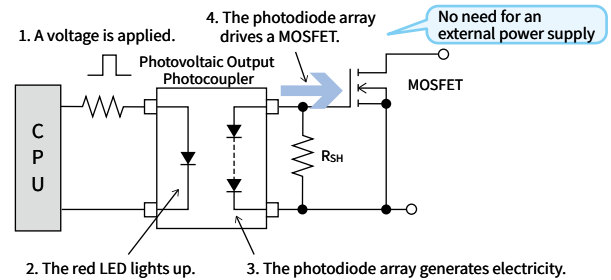

Example of a Circuit Composed of a Photovoltaic Output Photocoupler and a MOSFET

* The shunt resistor for discharging the gate capacitance (R_{SH}) reduces the MOSFET turn-off time.

Selection Table

Creepage / Clearance (mm)		—	5.0	4.0	6.4
Isolation Voltage (V_{rms})		1500	3750	2500	2500
Package		SSOP4	4pin SO6	4pin MFSOP6	5pin DIP6 (cut)
Features					
V_{oc} Min	Schematic	I_{sc} Min			
7 V	 General-purpose	5 μA	TLP3904		TLP3902
		12 μA		TLP3905 [C] [H]	TLP190B [C]
		20 μA	TLP3914		TLP590B [C]
	 Built-in shunt resistor	24 μA			TLP191B
		 Built-in discharge circuit	12 μA		TLP3906 [C] [H]
	30 V	 General-purpose	4 μA	TLP3924	

V_{oc} (V): Open Voltage

I_{sc} (μA): Short-circuit current

[H]: Extended operating ambient temperature range of up to 125°C

Gain Rank

[C] Photocouplers with the C mark are available with the C20 short-circuit rank.

Rank	I_{sc} (μA) Min
None	12
C20	20

Photocouplers for Automotive

Automotive photocouplers undergo reliability tests more stringent than those for the conventional general-purpose photocouplers in order to ensure higher quality and reliability.

Photocouplers for automotive applications are identified by part numbers beginning with TLX9. Automotive photocouplers undergo lot-by-lot screening whereas typical photocouplers are screened according to the week of manufacture. In addition, automotive photocouplers have a special marking for enhanced traceability. These photocouplers are compliant with AEC-Q101, an automotive qualification standard.

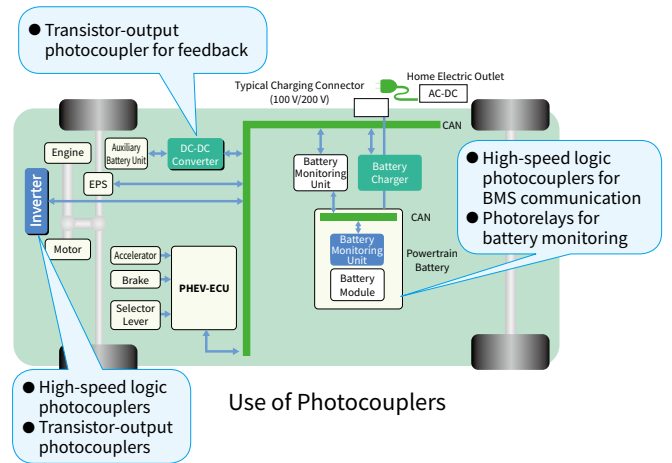

Selection Table

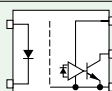
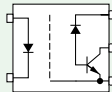
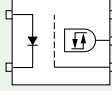
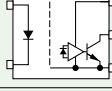
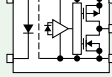

High-Speed Logic Photocouplers

Creepage / Clearance (mm)			5.0
Isolation Voltage (V_{rms})			3750
Features			Package 5pin SO6 
Data Rate	Output Form	Internal Connections	
1 Mbps	OC	Digital	 TLX9304
1 Mbps	OC	Analog	 TLX9309
5 Mbps	TP	BUF	 TLX9310
10 Mbps	OC	Digital	 TLX9378
20 Mbps	TP	INV	 TLX9376

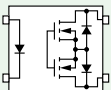

Photorelays 1-Form-A

Creepage / Clearance (mm)			5.0
Isolation Voltage (V_{rms})			3750
Features			Package 4pin SO6 
V_{OFF} Min	I_{ON} Max	Internal Connections	
600 V	15 mA		TLX9175J

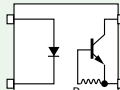
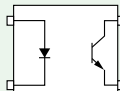
Transistor-Output Photocouplers

Creepage / Clearance (mm)		5.0	5.0
Isolation Voltage (V_{rms})		3750	3750
Features		Package SO4 	Package 4pin SO6 
Input Type	Internal Connections		
DC Input		TLX9000	TLX9300
		TLX9291A	TLX9185A

Photovoltaic Output Photocouplers

Creepage / Clearance (mm)		5.0
Isolation Voltage (V_{rms})		3750
Features		Package 4pin SO6 
Discharging Circuit	Internal Connections	
N		TLX9905
Y		TLX9906

OC: Open Collector Output
TP: Totem Pole Output

Photorelays

Photorelays have a pair of MOSFETs at the output stage and provide the same function as mechanical relays and reed relays. Photorelays offer many advantages over mechanical relays such as long service life, low-current drive and fast response. Photorelays are widely used for contact switching in semiconductor test systems, security systems, etc.

Toshiba offers photorelays with low on-resistance (R_{ON}) and low output terminal capacitance (C_{OFF}) in ultra-small packages for semiconductor test system applications, and general-purpose photorelays in various packages featuring high current and high off-state voltage.

▶ Photorelay Operation

Two MOSFETs are connected in a common-source configuration at the output stage. This configuration makes it possible to turn on and off both AC and DC currents.

The basic configuration of a photorelay is shown at right. These MOSFETs are driven by an array of a few to a few dozen series-connected photodiodes. When the photodiode array receives a light from the LED on the input side, it generates 7 to 10+ volts, turning on the MOSFETs.

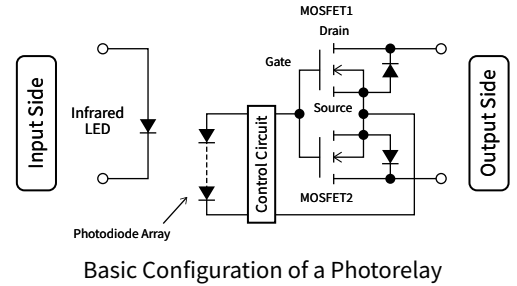

▶ Benefits of Using Photorelays

A mechanical relay has mechanical contacts, whereas a photorelay consists of semiconductor contacts whose output stage is composed of MOSFETs. Compared with mechanical relays, photorelays have the following benefits:

Fast switching & low noise

Since photorelays have no mechanical contacts, they switch much faster and generate less electric noise than mechanical relays.

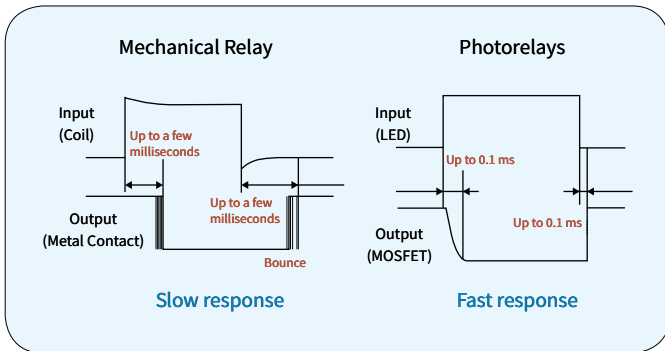

Power-efficient

Due to a low drive supply current of a few milliamperes, photorelays help reduce the system power consumption.

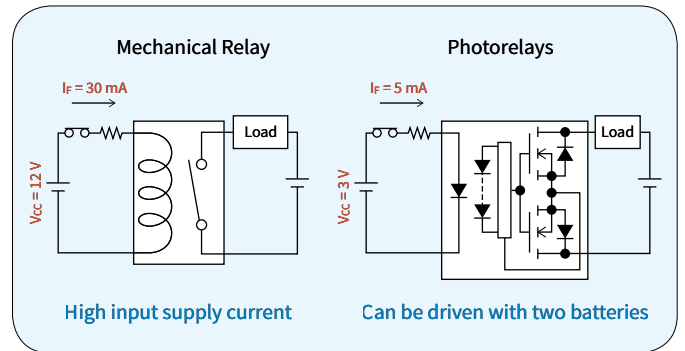

Small footprint

Due to small size, photorelays require much less board space.

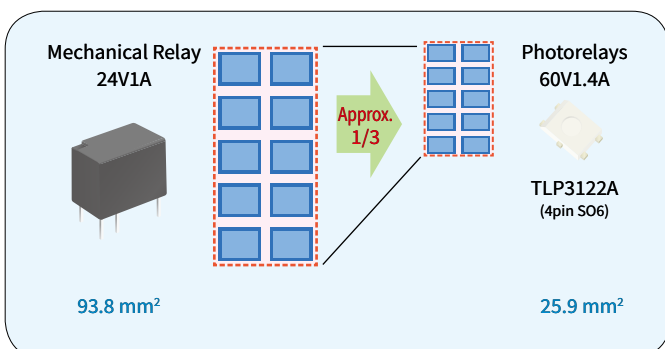

Long life

Photorelays provide high reliability and long life because they have no mechanical contacts.

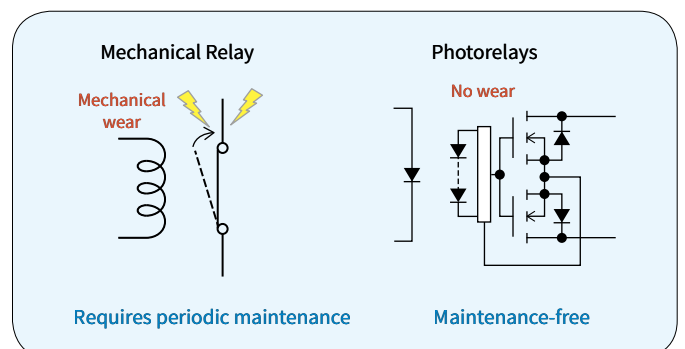

► Features of Toshiba's Photorelays

Integrated process from chip fabrication to assembly

Toshiba is capable of providing highly reliable products as it performs the entire process from chip fabrication at the front end to part assembly at the back end.

Latest MOSFET process

Toshiba can develop high-quality photorelays since the latest MOSFET design and process technologies developed in-house become available in a timely manner for incorporation into photorelays.

Ultra-small packages

Toshiba offers the world's smallest packages, drawing on the expertise for small packages accumulated from its experiences with discrete devices.

► Packages for Photorelays

Toshiba offers photorelays in the world's smallest packages mainly for semiconductor test equipment applications.

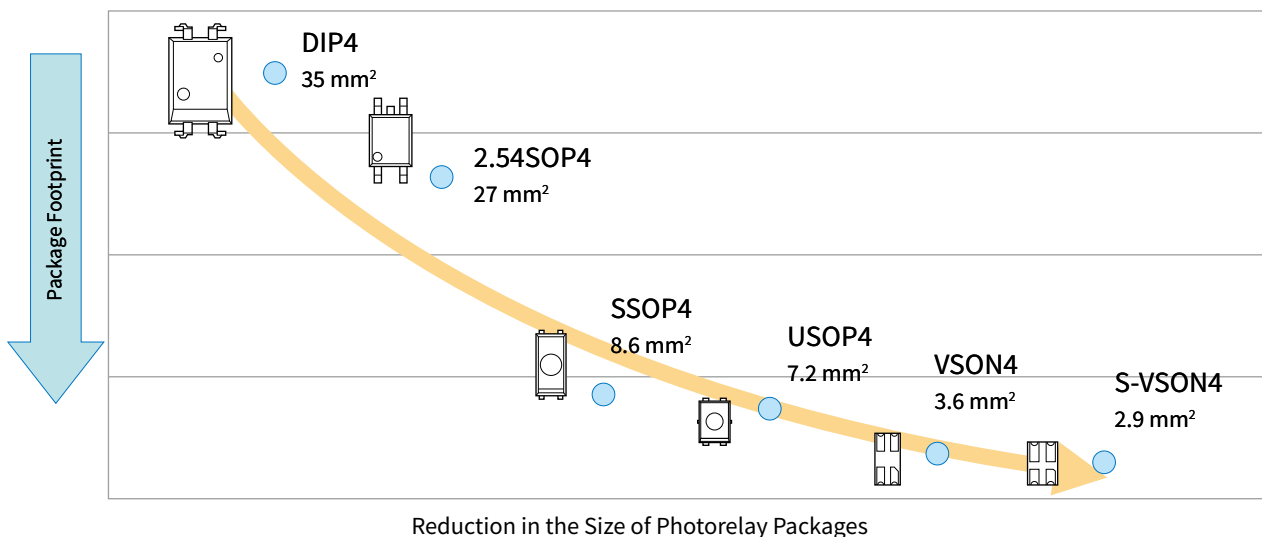

Form-A and Form-B Contacts

A **Form-A contact** is closed when a current higher than a given value is applied to the input side. The Form-A contact is also known as a Normally Open (NO) contact.

1-Form-A (1a) denotes a single-pole, single-throw Form-A relay whereas 2-Form-A (2a) signifies a double-pole Form-A relay.

In contrast, a **Form-B contact** opens when a current higher than a given value is applied to the input side and is closed when the current drops below a given value. The Form-B contact is also known as a Normally Closed (NC) contact.

1-Form-B (1b) denotes a single-pole, single-throw Form-B relay whereas 2-Form-B (2b) signifies a double-pole Form-B relay.

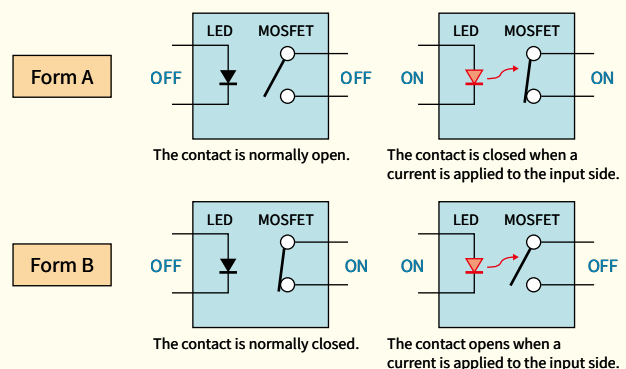











Product of resistance and capacitance of a photorelay

The product of resistance and capacitance (RC product) is one of the important figures of merit for photorelays designed to switch a radio-frequency (RF) or high-speed signal. "C" as in RC refers to the capacitance across the output terminals, C_{OFF} , when a photorelay is off. "R" is the resistance across the output terminals, R_{ON} , when a photorelay is on. A large C_{OFF} causes a current leakage as an RF signal passes through a relay even while it is open. A high R_{ON} causes an insertion loss and signal deterioration. Therefore, for RF switching applications, photorelays with low C_{OFF} and low R_{ON} (i.e., a low RC product) are desirable.

■ Selection Table

1-Form-A (Surface-Mount Package)

(1/2)



Creepage / Clearance (mm)		—	—	—	—	—	—	—	5.0	4.0	4.0
Isolation Voltage (V _{rms})		500	500	500	500	500	1000	1500	3750	1500	1500
Package		S-VSON4T	S-VSON4	VSON4	VSONR4	P-SON4	USOP4	SSOP4	4pin SO6	2.54SOP4	2.54SOP6
Features											
V _{OFF} (V) Min	I _{ON} (A) Max										
20	0.16						TLP3330	TLP3230			
	0.20			TLP3450*			TLP3350	TLP3250			
	0.45			TLP3431*				TLP3231			
	0.90						TLP3303	TLP3203			
	1.0			TLP3403*	TLP3403R*						
2.5										TLP3100	
30	1.5	TLP3406SRH* TLP3406SRL*	TLP3406S*								
	3.3									TLP3146*	
	4.0										TLP3106
	4.5					TLP3480**					TLP3106A*
40	0.10			TLP3442*			TLP3342				
	0.12	TLP3440S*		TLP3440*			TLP3340	TLP3216 TLP3240			
	0.14			TLP3441*			TLP3341	TLP3241			
	0.25			TLP3414*				TLP3214			
	0.30						TLP3315	TLP3215			
	1.0									TLP3123	
50	2.5										TLP3102
	0.30			TLP3475*	TLP3475R*		TLP3375	TLP3275			
60	0.10								TLP175A		
	0.12			TLP3451*			TLP3351				
	0.40	TLP3412SRH*	TLP3475S*	TLP3412*	TLP3412R*		TLP3312	TLP3212		TLP170A TLP171A	TLP192A
	0.50								TLP172AM*		
	0.70								TLP176AM*		
	1.0	TLP3407SRH* TLP3407SRL* TLP3407SR*	TLP3407S*								TLP3122
	1.4								TLP3122A*		
	1.7									TLP3127	
	2.3										TLP3103
	2.5										TLP3147*
	3.0					TLP3481**					
75	3.3										TLP3107
	4.0										TLP3107A*
80	0.40						TLP3306				
	0.12			TLP3417*			TLP3317	TLP3217			
100	0.20			TLP3419*			TLP3319				
	0.08							TLP3220			
	0.10			TLP3420*			TLP3320				
	0.65		TLP3409S*								
	1.4										TLP3105
	1.5										TLP3149*
	2.0					TLP3482**					TLP3109
200	3.0										TLP3109A*
	0.05									TLP179D	TLP199D
	0.20									TLP170D TLP171D TLP176D	
	0.35					TLP3483**					
350	0.40									TLP3145	
	0.10								TLP170G		
	0.11							TLP172GM*			TLP192G
400	0.12									TLP174G TLP176G	TLP197G
	0.10									TLP171GA	
	0.11							TLP172GAM*			
	0.12									TLP174GA TLP176GA	TLP197GA
600	0.18				TLP3484**						
	0.07									TLP171J	
	0.09									TLP170J	

*: New product

** : Under Development

1-Form-A (Through-Hole Package)

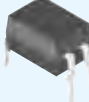
(2/2)

Creepage / Clearance (mm)		7.0	8.0	7.0	8.0	7.0
Isolation Voltage (V _{rms})		2500/5000	5000	2500/5000	5000	2500
Features		DIP4		DIP6		DIP8
						
V _{OFF} (V) Min	I _{ON} (A) Max					
20	3.0	TLP3553				
	4.0			TLP3543		
30	3.5	TLP3553A*				
	5.0			TLP3543A*		
40	2.0	TLP241A*	TLP241AF*			
	2.5	TLP3554				
	3.5			TLP3544		
60	0.5	TLP222A		TLP592A		
		TLP240A	TLP240AF	TLP597A		
			TLP598AA			
	2.0	TLP3555				
	2.5			TLP3542		
3.0	TLP3555A*		TLP3545			
4.0			TLP3545A*			
5.0					TLP3547*	
100	1.0	TLP3556				
	2.0	TLP3556A*		TLP3546		
	3.0					TLP3823*
	3.5			TLP3546A*		
200	0.25	TLP240D	TLP240DF			
	0.30	TLP222D				
	0.70	TLP3558A*				
	1.5					TLP3825*
350	0.10	TLP240G	TLP240GF			
	0.12	TLP222G		TLP592G		
		TLP224G		TLP597G		
TLP228G						
400	0.12	TLP224GA		TLP597GA		
		TLP240GA	TLP240GAF	TLP797GA	TLP797GAF	
	0.15			TLP598GA		
0.40			TLP798GA		TLP3548*	
600	0.09	TLP240J	TLP240JF			
	0.10			TLP797J	TLP797JF	
	0.60					TLP3549*

V_{OFF} (V): OFF-state output terminal voltage

*: New product



I_{ON} (A): On-state current

Trigger LED current



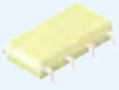

To activate the output of a photorelay or a photocoupler, application of an input current called trigger LED current is required at a minimum.

In practice, the LED current should be set to a value greater than the maximum trigger LED current specified in a datasheet.



2-Form-A

Creepage / Clearance (mm)		4.0	7.0
Isolation Voltage (V_{rms})		1500	2500
Features		Package	
		2.54SOP8	DIP8
V_{OFF} (V) Min	I_{ON} (A) Max		
60	0.4	TLP202A TLP206A	
	0.5		TLP222A-2
200	0.2	TLP200D	
350	0.11	TLP202G	
	0.12	TLP206G	TLP222G-2 TLP224G-2 TLP228G-2
400	0.12	TLP206GA	TLP224GA-2

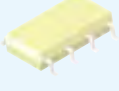

1-Form-B

Creepage / Clearance (mm)		4.0	4.0	7.0	7.0
Isolation Voltage (V_{rms})		1500	1500	2500	2500
Features		Package			
		2.54SOP4	2.54SOP6	DIP4	DIP6
V_{OFF} (V) Min	I_{ON} (A) Max				
60	0.5	TLP4176A			
350	0.12	TLP4176G	TLP4197G		
	0.15			TLP4227G	TLP4597G

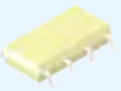

2-Form-B

Creepage / Clearance (mm)		4.0	7.0
Isolation Voltage (V_{rms})		1500	2500
Features		Package	
		2.54SOP8	DIP8
V_{OFF} (V) Min	I_{ON} (A) Max		
350	0.12	TLP4206G	
	0.15		TLP4227G-2

1-Form-A, 1-Form-B

Creepage / Clearance (mm)		4.0	7.0
Isolation Voltage (V_{rms})		1500	2500
Features		Package	
		2.54SOP8	DIP8
V_{OFF} (V) Min	I_{ON} (A) Max		
350	0.12	TLP4026G	TLP4006G

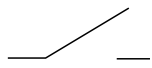
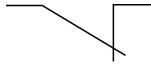
Contact Symbols

Name	Form A	Form B
Synonyms	Normally Open (NO) Make	Normally Closed (NC) Break
Number of contacts	1	1
Definition	The switch is normally open, and is closed when activated.	The switch is normally closed, and opens when activated.
JIS symbol (JIS C 0617)		
Obsolete JIS symbol (JIS C 0301)		

► Packaging

To help reduce the system size and thickness, Toshiba is developing small, thin packages for photocouplers.

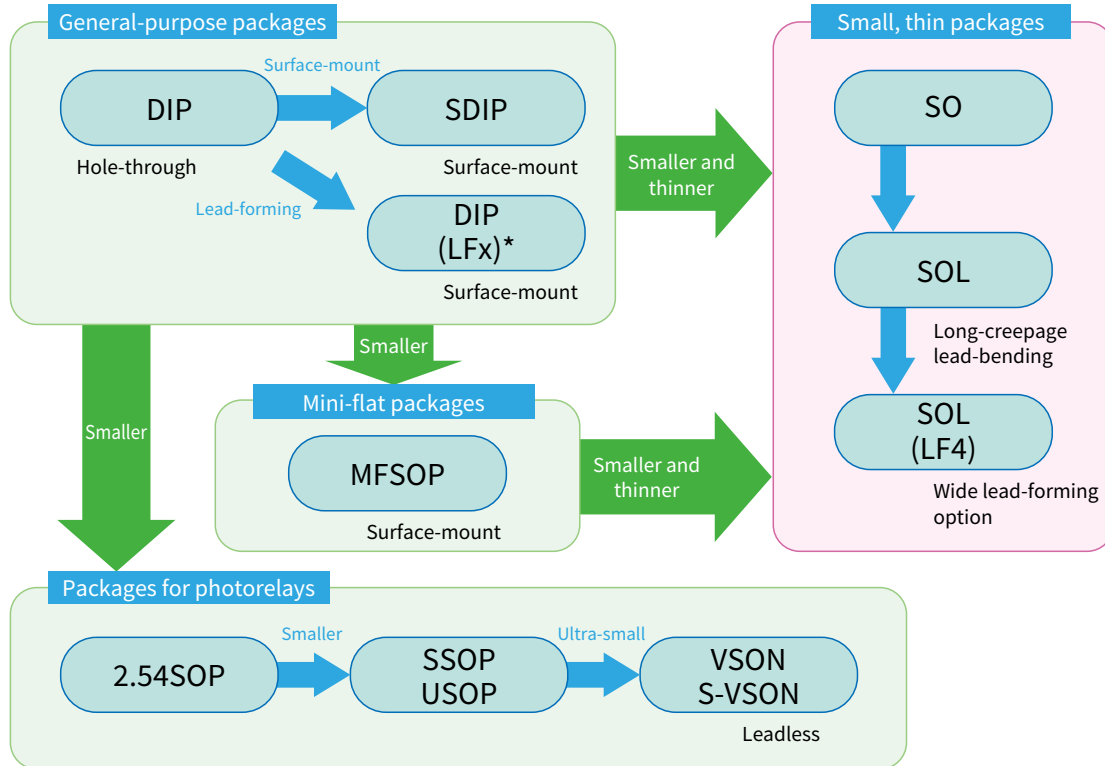

* Toshiba offers lead-forming options for DIP packages that make them surface-mountable. Lead-forming options are represented by suffixes such as (LF1), (LF4), and (LF5).

► Internal Structures of Photocouplers

Photocouplers are constrained by various factors, including the insulation performance requirement, package size, and chip size. Therefore, packages for photocouplers are available with several internal structure variations.

(A) Single-molded reflective type	(B) Single-molded transmissive type	(C) Single-molded transmissive type with film	(D) Double-molded transmissive type
Mainly, reflected light reaches a photosensor.	Both direct and reflected light reach the photosensor.	Both direct and reflected light reach the photosensor.	Mainly, direct light reaches the photosensor.
A frame-mounted LED is flush with a frame-mounted photosensor. This device is known as a reflective photocoupler since the LED light is reflected inside the silicone resin before reaching a photosensor.	A frame-mounted LED and a frame-mounted photosensor face each other. The light-transmissive sections of the LED and the photosensor are made of silicone resin.	To increase isolation voltage, a polyimide film is inserted between an LED and a photosensor.	An LED and a photosensor face each other. The inner mold is white whereas the outer mold is black. A mold resin with high infrared transmissivity is used for the white mold in the light-transmissive section.

Through-Hole Packages

DIP Packages

In addition to DIP packages with standard leads, Toshiba offers Type-F DIP packages with a greater lead width that provide a longer creepage distance.

 **Standard Packages** Creepage / Clearance: 6.4/7.0 mm

Standard DIP packages
Toshiba also offers DIP packages with part of the leads cut off.

 **Wide Size Lead Bend Option** Creepage / Clearance: 8 mm

Type-F DIP packages have wider leads than standard DIP packages. These packages are suitable for applications requiring a creepage distance of 8 mm or more on a printed circuit board.

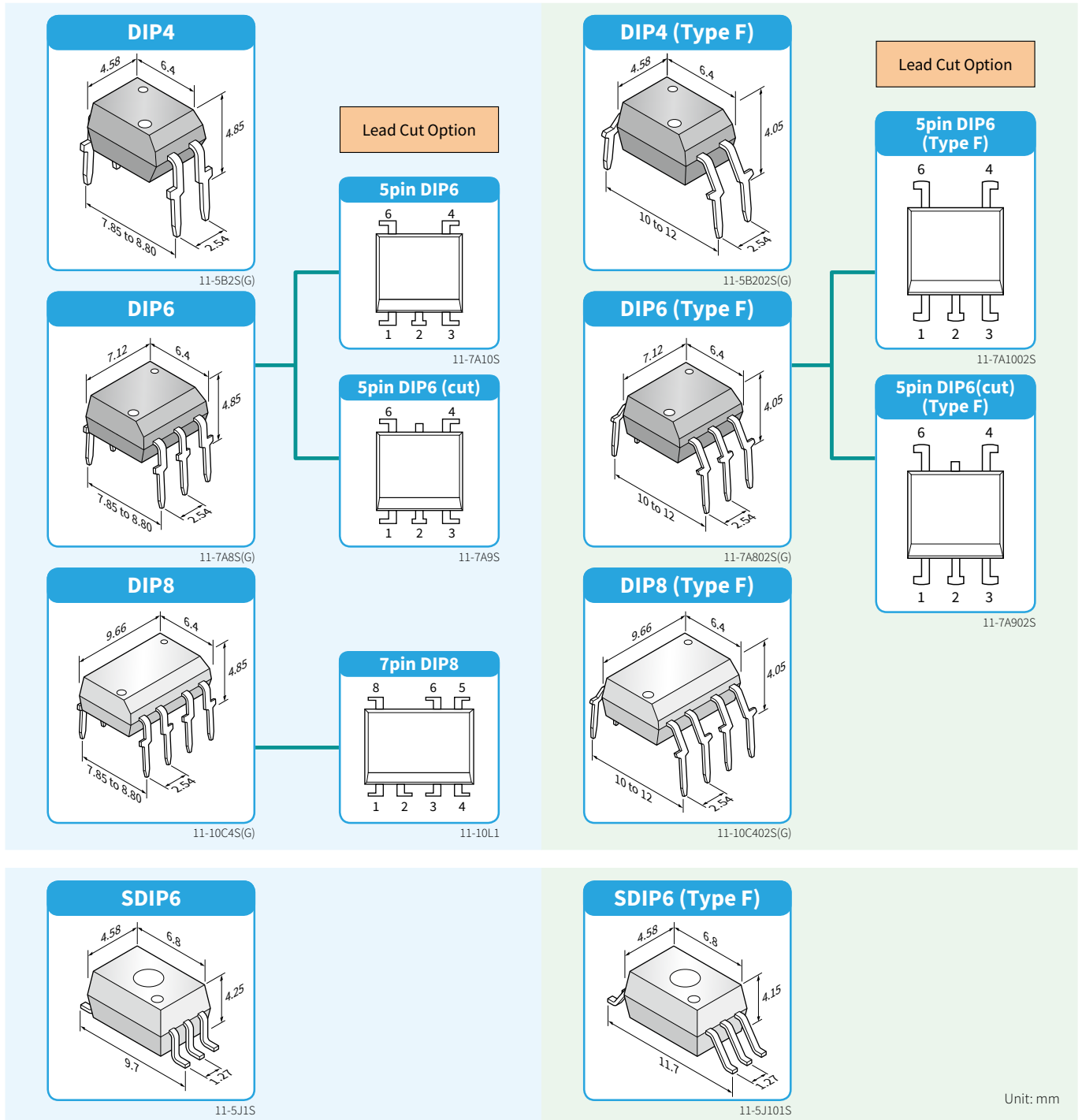

Unit: mm

DIP: Dual In-line Package / SDIP: Shrink Dual In-line Package

* All values are nominal values, not including tolerances. For tolerances, see the datasheets for individual photocouplers.

* The package heights are the maximum board-mounted heights, which are the sum of the package body height and the stand-off height (i.e., the distance from the board surface to the bottom of the package body).

* The TLP785 has different external dimensions from the values shown above. See the datasheet for the TLP785 for its dimensions.

Lead-Forming Options for DIP Packages

Toshiba offers several lead-forming options for photocouplers in the DIP4, DIP6, and DIP8 packages (including Type F) to make them surface-mountable.

The electrical characteristics of the photocoupler are not affected by lead-forming.

	Through-Hole		Surface-Mount		
Lead Form Code	Standard	Type F (LF2)	(LF1)	(LF5)	(LF4)
Taping Code	—	—	(TP1)	(TP5)	(TP4)
Appearance					
Package Outline					
Creepage / Clearance	6.4 / 7.0 (mm)	8.0 (mm)	6.4 / 7.0 (mm)	6.4 / 7.0 (mm)	8.0 (mm)

* The lead-forming options for the TLP785 are named (LF6) and (LF7). For details, see its datasheet.

Unit: mm

■ Packages with Lead-Forming Options

Type F (long creepage type) is identical to the LF2 lead-forming option available with standard DIP packages.

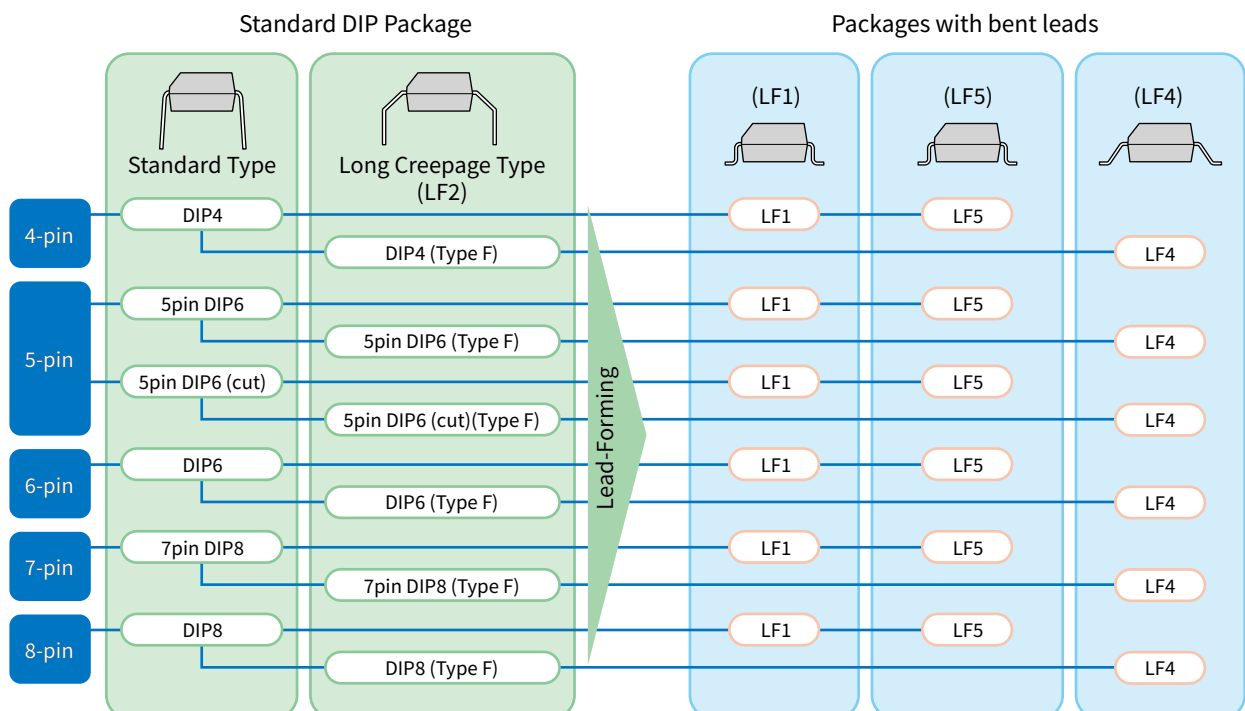

Surface-Mount Package

SO Packages

A wide-lead option (LF4) is available for packages with a long creepage distance. The SO6L(LF4) package can be soldered on the land patterns for the SDIP6 (Type F) package.

 **Standard Packages**

Creepage / Clearance: 4 mm / 5 mm

 **Wide Size Lead Bend Option**

Creepage / Clearance: 8 mm

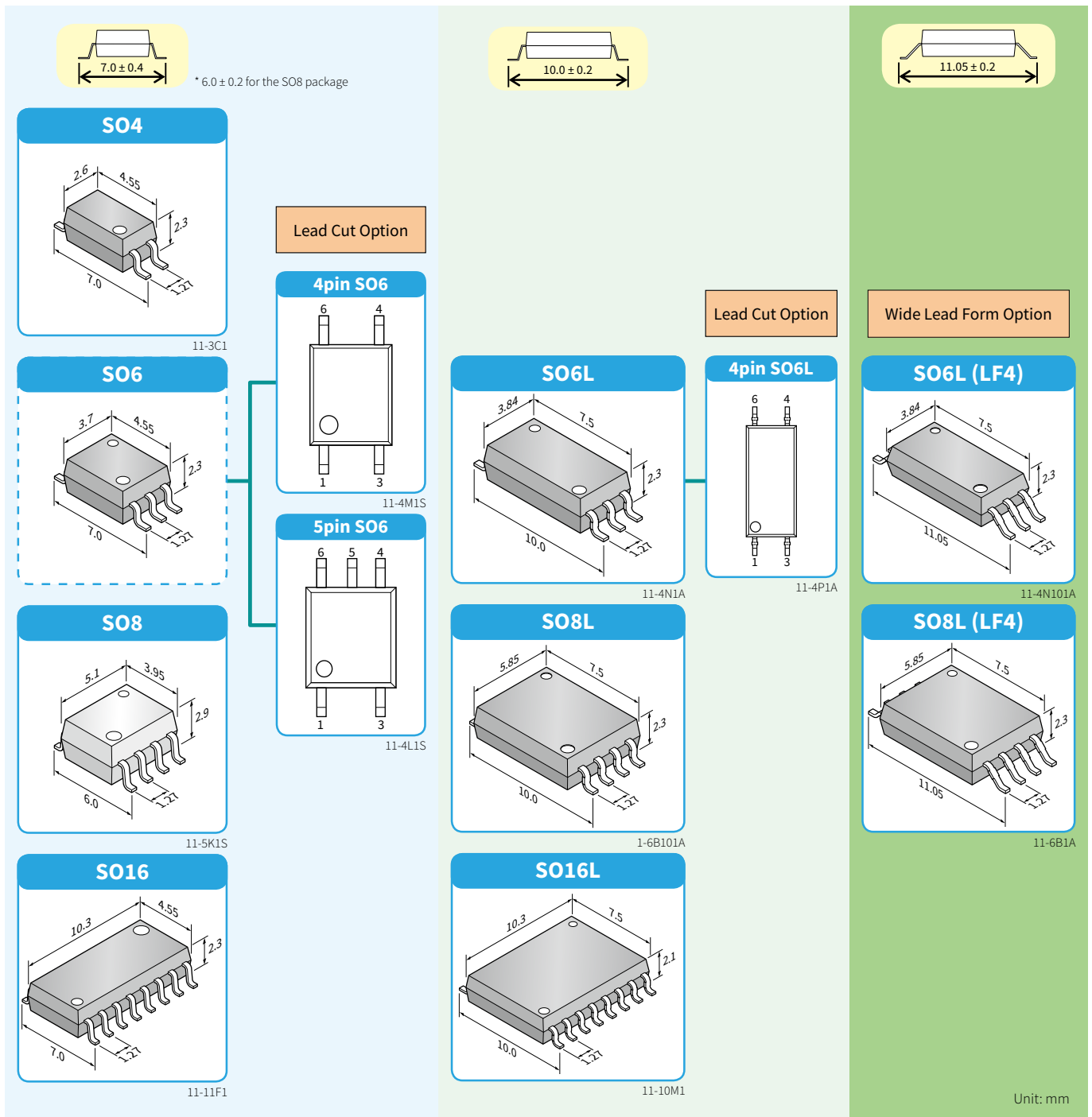

* All values are nominal values, not including tolerances. For tolerances, see the datasheets for individual photocouplers.

* The package heights are the maximum board-mounted heights, which are the sum of the package body height and the stand-off height (i.e., the distance from the board surface to the bottom of the package body).

■ MFSOP Packages

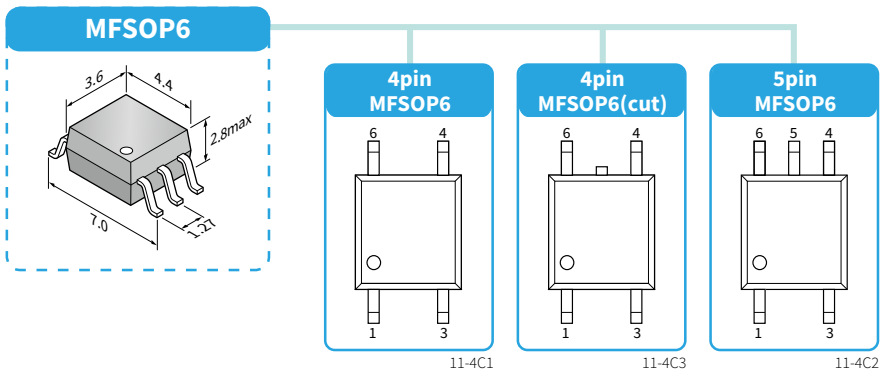

MFSOP: Mini Flat Small Outline Package

■ 2.54SOP Packages

The 2.54SOP packages are surface-mount packages with a lead pitch of 2.54 mm.

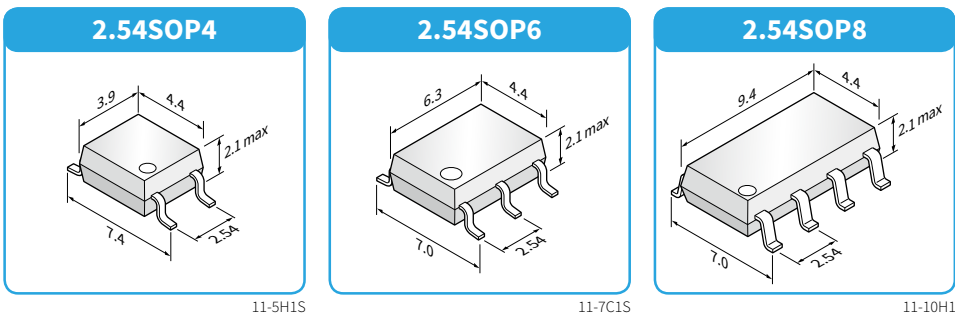

■ S-VSON/VSON/USOP/SSOP Packages

These packages are designed specifically for photorelays to help increase the board density.

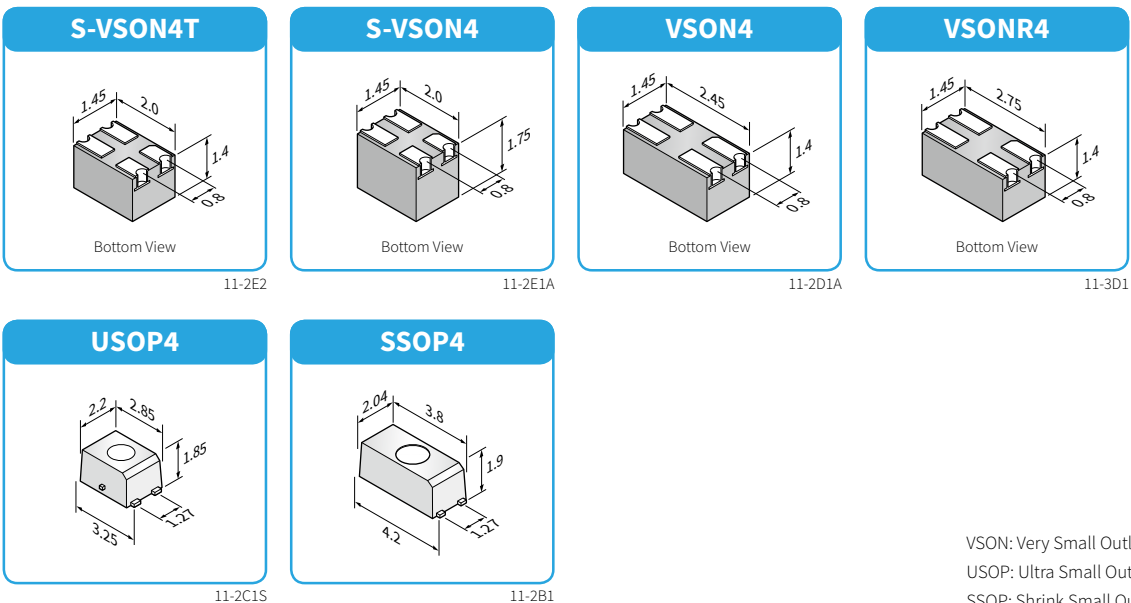

VSON: Very Small Outline Non-leaded Package

USOP: Ultra Small Outline Package

SSOP: Shrink Small Outline Package

Safety Standards

Photocouplers are used in electronic equipment to provide electrical isolation between two circuits. Therefore, photocouplers are subject to safety regulations according to their applications.

Each nation has safety standards established based on international standards. Toshiba's photocouplers have been certified to national safety standards by accredited certification bodies in each country.

■ Safety Standards

International electric, electronic, and communication standards are established by the International Electrotechnical Commission (IEC). Regional standards are developed based on the IEC standards, taking differences in voltage and other factors into account. In addition, national safety standards are established based on the IEC and regional standards.



■ Equipment and Parts Standards

The safety standards are divided into equipment standards that apply to end products and parts standards that apply to individual photocouplers. The safety standards for photocouplers are listed below. The accredited certification body in each country examines compliance with these safety standards and issues certificates.

Each photocoupler is certified to appropriate safety standards according to its applications. For information on the compliance with safety standards, see Toshiba's website or technical datasheets for each photocoupler.

Major Safety Standards		IEC Standard	EN Standard	National Standards
Equipment standards	Standards for information technology equipment	IEC 60950-1 IEC 62368-1	EN 60950-1 EN 62368-1	DIN EN 60950-1, DIN EN 62368-1 [Germany] GB4943-1 (IEC 60950-1 MOD ¹) [China]
	Standards for audio, video and similar electronic apparatus	IEC 60065 IEC 62368-1	EN 60065 EN 62368-1	DIN EN 60065, DIN EN 62368-1 [Germany] GB8898 (IEC 60065 MOD ¹) [China]
	Control equipment standard for industrial control switches and non-motor loads	—	—	UL 508 [U.S.]
Parts standards	Photocoupler standards	—	—	UL 1577 [U.S.] CA 5A (cUL ²) [Canada]
		IEC 60747-5-5	EN 60747-5-5	DIN EN 60747-5-5 [Germany]

■ Major Safety Standards for Photocouplers

Toshiba's photocouplers are certified to the major safety standards listed below.

The photocouplers certified to EN 60747-5-5 require a partial discharge test in addition to the typical shipment tests.

These photocouplers are distinguished by the (D4) or (V4) option.

(D4) option: Photocouplers in DIP, SDIP, SOxL, and other packages with creepage and clearance distances of 6.4 mm or more

(V4) option: Photocouplers in SO4, SO6, MFSOP6, and other packages with creepage and clearance distances of 5 mm or less

Organization	Country/Region	Safety Standards	
UL	U.S./North America	UL 1577, UL 508	IEC: International Electrotechnical Commission
CSA	Canada/North America	CA 5A (cUL ²)	EN: European Norm / European Standard
VDE	Germany/Europe	DIN EN / EN 60747-5-5	UL: Underwriters Laboratories Inc.
		DIN EN / EN 62368-1	CSA: Canadian Standards Association
CQC	China	GB4943 (IEC60950MOD)	VDE: Verband Deutscher Elektrotechnischer e.V.
		GB8898 (IEC60065MOD)	CQC: China Quality Certification center
			DIN: Deutsches Institut für Normung

*1: The "MOD" suffix denotes a Chinese version modified based on the IEC standard.

*2: The United States and Canada have a mutual recognition agreement. UL products certified for Canada are also recognized for conformance to CSA under a mutual recognition agreement and can bear the cUL mark.

Toshiba's cUL-recognized photocouplers for the Canadian market are certified under UL1577, but not UL508.

■ Structural Parameters

For photocouplers, several structural parameters are defined in relation to the distances between two conductors that must be isolated from each other.

Structural Parameters	Description
Isolation Voltage	The maximum allowable voltage that can be applied across the input and output pins
Creepage Distance	The shortest distance between two conductors (i.e., input and output pins) over an insulator's surface
Clearance	The shortest distance between two conductors (i.e., input and output pins) through air
Distance through Insulation	The minimum thickness of an insulator between two conductors (i.e., input and output pins)

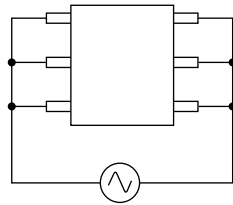

Isolation voltage

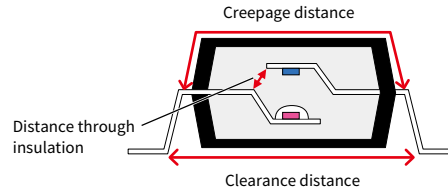

■ Internal Structures and Structural Parameters of Photocouplers

The following table shows the structural parameters of each package and the maximum permissible voltages defined by the EN 60747-5-5 standard.

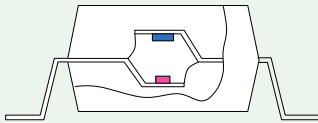
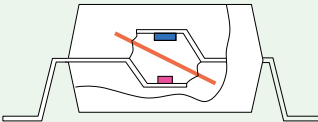
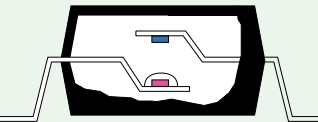
Internal Construction	Package	Construction Mechanical Ratings			VDE-approved EN 60747-5-5	
		Creepage Distance (mm)	Clearance (mm)	Distance through Insulation (mm)	Repetitive Peak Isolation Voltage V_{IORM} (Vpeak)	Maximum Transient Isolation Voltage V_{IOTM} (Vpeak)
 Transmissive Photocouplers in Single-Molded Packages	MFSOP6	4.0	4.0	—	565	4000
	SO8 (2ch)	4.2	4.2	—	565	4000
	2.54SOP	4.0	4.0	—	565	2500
	DIP	6.4 / 7.0	6.4 / 7.0	(0.4)	630 / 890	4000
 Transmissive Photocouplers with an Insulating Film in Single-Molded packages	Type F	8.0	8.0	(0.4)	1140	6000
	SO8 (1ch)	4.0	4.0	—	565	6000
	SDIP6	7.0	7.0	0.4	890	8000
	Type F	8.0	8.0	0.4	1140	8000
 Transmissive Photocouplers in Double-Molded Packages	DIP	6.4 / 7.0	6.4 / 7.0	0.4	890	6000 / 8000
	Type F	8.0	8.0	0.4	1140	6000 / 8000
	MFSOP6	4.0	4.0	—	565	4000 / 6000
	SO4	5.0	5.0	0.4	707	6000
	SO6	5.0	5.0	0.4	707	6000
	SO6L	8.0	8.0	0.4	1140 / 1230	8000
	SO8					
	SO8L	8.0	8.0	0.4	1230	8000
SO16	5.0	5.0	—	565	4000	
SO16L	8.0	8.0	0.4			
DIP	6.5 / 7.0	6.5 / 7.0	0.4	890 / 1130	6000 / 8000	
Type F	8.0	8.0	0.4	1130	6000 / 8000	

Part Naming Conventions

Toshiba's photocouplers and photorelays have a three- or four-digit part number. The letters following the number provide additional ordering information.

3-Digit Part Numbering

TLP 3 60 G F

- ① ② ③ ④ ⑤ ⑥

① Product Group

Denotes either a photocoupler or a photorelay

② Package / Isolation Voltage

Package / Isolation Voltage	
1	SOP
2	SOP / SOP16 DIP (2500 / 5000 V _{rms})
3	SO6L DIP (5000 V _{rms})
4	DIP4 (5000 V _{rms})
5	DIP (2500 V _{rms})
6	DIP (5000 V _{rms})
7	DIP (4000 V _{rms})

③ Output Type

Product Category / Output Type	
00 - 09	IC output, Photorelays
10 - 19	IC output
20 - 29	4-, 8-, or 16-pin package
30 - 39	6-pin package
40 - 49	Thyristor output, Photorelays
50 - 59	IC output
60 - 69	Triac output
70 - 79	Transistor output, Photorelays
80 - 89	Transistor output
90 - 99	Transistor output, Photovoltaic output, Photorelays

④ Off-state voltage

Triac output (V _{DRM}) Thyristor output (V _{DRM})	
G	400 V
J	600 V
L	800 V

Photorelays (V _{OFF})	
A	40 V / 60 V
D	200 V
G	350 V
GA	400 V
J	600 V

May be null for photorelays

⑤ Revision Code

This letter denotes a revision. The revision code is an uppercase letter starting with A.

⑥ Lead forming

The suffix "F" denotes lead-forming that provides a long creepage distance.

4-Digit Part Numbering

TLP 2 7 68 H F

- ① ② ③ ④ ⑤ ⑥ ⑦

① Product Group

Denotes either a photocoupler or a photorelay

② Output Type

Product Category	
2	IC output (high-speed logic photocoupler, IPM driver)
3	Photorelay (Form A), triac- or photovoltaic output photocoupler
4	Photorelay (with a contact other than Form A)
5	IC output (IGBT/MOSFET driver)
7	Isolation amplifier

③ Package

When ② is 3 or 4

Product Category / Output Type	
0	Thyristor output
1	Photorelays SOP
2	Photorelays SSOP
3	Photorelays USOP
4	Photorelays VSON
5	Photorelays DIP
7	Triac output
9	Photovoltaic output

When ② is 2, 5 or 7

Package	
0	SO4 / MFSO6
1	SO8 (Dual)
3	SO6
4	SO8 (Single)
6	DIP8 (Dual)
7	SDIP6 / SO6L
9	DIP8 (Single)

④ Off-state voltage / Property

Triac output (V _{DRM})	
30 - 39	400 V / NZC
40 - 49	400 V / ZC
50 - 59	600 V / NZC
60 - 69	600 V / ZC
70 - 79	800 V / NZC
80 - 89	800 V / ZC

Photorelays	
00 - 09	High-current type
10 - 39	Standard type
40 - 69	Low-C _{OFF} type

Photovoltaic output	
00 - 19	Standard type Economic type
20 - 29	High-V _{CC} type

⑤ Features

Denotes a product feature

⑥ Revision Code

This letter denotes a revision. The revision code is an uppercase letter starting with A.

⑦ Lead forming

The suffix "F" denotes lead-forming that provides a long creepage distance.

Additional Codes

The additional codes following a part number denote a safety standard, performance rank, taping, and other ordering information.

TLP **(D4 - GR - TP ,U ,F (O**

① ② ③ ④ ⑤ ⑥ ⑦ ⑧

①	Part number	Denotes a part number for a product.	
②	Separators symbol	The left parenthesis separates a part number and the following additional codes. The parenthesis cannot be omitted.	
③	Safety Standard option	Safety standard option	e.g., D4: EN 60747-certified (DIP package) V4: EN 60747-certified (SOP package)
④	CTR / I _{FT} / I _{sc} / Gain rank	Transistor-output: Current transfer ratio (CTR) rank. See Table 1.	e.g., GR: CTR rank (100 to 300%)
		Triac output: Trigger LED current (I _{FT}) rank. See Table 2.	e.g., IFT5: 5-mA trigger LED current (max)
		Photovoltaic output: Short-circuit current (I _{sc}) rank. See Table 3.	e.g., C20: 20-μA short-circuit current (min)
		Isolation amplifier: Gain rank. See Table 4.	e.g., A: ±1% gain
⑤	Taping / Lead forming	Taping option. See Table 5.	e.g., TP1: (LF1) lead-forming, taping e.g., TPL: (TPL) taping
		Lead-forming (only for DIP packages). See Page 27.	e.g., LF4: (LF4) lead-forming, sticks
⑥	Modify code	This code may be added for a modified product.	e.g., U: Lead material and limited plated version e.g., J: Modified LED chip
⑦	RoHS Compatible (*)	RoHS compliance	e.g., F: Compliant with European RoHS e.g., E: Compliant with European RoHS and halogen-free
⑧	Country of origin	Country of origin	e.g., (O: Manufactured in Japan e.g., (T: Manufactured in Thailand

* Please contact your Toshiba sales representative for details of RoHS compliance of each product.

Note: There is a limit to the number of characters. For longer order numbers, the hyphen and comma characters may be omitted or additional codes may be abbreviated.

Figure 1. Current Transfer Ratio (CTR) (Transistor Output)

Symbol	CTR
Null	50 to 600% 50 to 400%
Y	50 to 150%
YH	75 to 150%
GR	100 to 300%
GRL	100 to 200%
GRH	150 to 300%
GB	100 to 600% 100 to 400%
BL	200 to 600%
BLL	200 to 400%
LA	50 to 600%
LGB	100 to 600%

Table 2. Trigger LED Current (I_{FT}) (Triac output)

Symbol	Trigger LED Current (Max)
Null	3 / 10 mA
IFT7	7 mA
IFT5	5 mA
IFT2	2 mA

Table 3. Short-Circuit Current (I_{sc}) (Photovoltaic output)

Symbol	Short-Circuit Current (Min)
Null	12 μA
C20	20 μA

Table 4. Gain (Isolation amplifier)

Symbol	Gain
Null	±3%
A	±1%
B	±0.5%

Table 5. Taping

Symbol	Package
TP1 / TP4 / TP5	DIP4 / DIP6 / DIP8
TP6 / TP7	Only for the TLP785
TP	SDIP6 2.54SOP4 / SOP6 / SOP8 SSOP4 / VSON4 / S-VOSN4 SO4 / SO8 / SO16 SO6L / SO16L
TL	SO8L
TPL / TPR	MFSOP6 / SO6 / 4pin SO6L
TP15	SSOP4 / USOP4

Orderable part number example

TLP266J(V4T7TL,E → TLP266J(V4-IFT7-TPL,E

(This order number is abbreviated due to a limit to the number of characters.)

TLP266J: Triac output photocoupler with a V_{DRM} of 600 V

V4: EN 60747-5-5-certification option (SOP package)

IFT7: Trigger LED current = 7 mA (max)

TPL: TPL taping

E: Compliant with European RoHS, halogen-free

Selection Guide

Reading a Selection Guide

The product lists are not arranged in the order of part numbers. Instead, the product lists are sorted in such a manner as to simplify product selection. Three to four selection criteria are predefined.

Example of selecting a transistor-output photocoupler from the table

Input Type	Internal Connections	Features	Packages	Part Number	CTR (%)					V _{CEO} (V)	BV _s (Vrms) @ 1 min.	T _{opr} (°C)	
					Min	Max	@ I _F (mA)	@ V _{CE} (V)	Rank			Min	Max
DC Input		General-Purpose	SO4	TLP291(SE)	50	600	5	5	☆ 1	80	3750	-55	110
			SO16	TLP291-4	50	400	5	5	☆ 4	80	2500	-55	110
			4pin SO6	TLP185(SE)	50	600	5	5	☆ 1	80	3750	-55	110
			4pin SO6L	TLP385	50	600	5	5	☆ 1	80	5000	-55	110
			DIP4	TLP785	50	600	5	5	☆ 1	80	5000	-55	110
	(Type F)	TLP785F	50	600	5	5	☆ 1	80	5000	-55	110		

① Criteria for product selection ② Part Number ③ Other characteristics

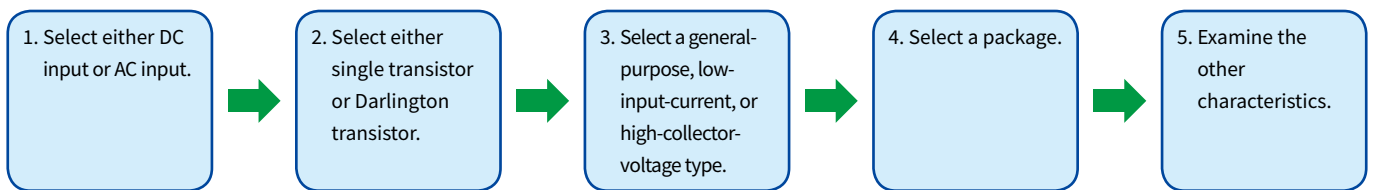

Order of Packages

Products in surface-mount packages are listed first, followed by those in hole-through packages. Each group of packages is sorted in the ascending order of footprint.

Package variants

There are several variations for each package such as Type F with a long creepage distance and Type LF4 with wide leads. These packages have wider leads than standard packages.

These variants are shown one level below the base standard packages. The unabbreviated package names are as follows:

Package	Part Number
DIP4	TLP785
(Type F)	TLP785F

Package	Part Number
SO6L	TLP2709
(LF4)	TLP2709(LF4)

Package	Part Number
DIP4	TLP785
DIP4 (Type F)	TLP785F

Package	Part Number
SO6L	TLP2709
SO6L (LF4)	TLP2709(LF4)

Abbreviated Representation Unabbreviated Representation

► Isolation Amplifiers / Isolated Delta-Sigma Modulators

Output Type	Pin Assignment	Packages	Part Number	Gain (V/V)			I _{DD1} (mA) Max	I _{DD2} (mA) Max	NL ₂₀₀ (%) Max	CMTI (kV/μs) Typ.	BVs (V _{rms}) @ 1 min.	T _{opr} (°C)	
				Typ.	Error	Rank						Min	Max
Analog Output		SO8L (LF4)	TLP7820	8.2	±3%	—	12	10	0.13	20	5000	-40	105
					±1%	A							
		DIP8	TLP7920	8.2	±3%	—	12	10	0.13	20	5000	-40	105
					±1%	A							
		(Type F)	TLP7920F	8.2	±3%	—	12	10	0.13	20	5000	-40	105
					±1%	A							
					±0.5%	B							
					±0.5%	B							

Output Type	Pin Assignment	Packages	Part Number	SNR (dB) Typ.	SNDR (dB) Typ.	INL (LSB) Typ.	I _{DD1} (mA) Max	I _{DD2} (mA) Max	CMTI (kV/μs) Typ.	BVs (V _{rms}) @ 1 min.	T _{opr} (°C)	
											Min	Max
Digital Output		SO8L (LF4)	TLP7830	80	75	4	12	8	20	5000	-40	105
		DIP8	TLP7930	80	75	4	12	8	20	5000	-40	105
		(Type F)	TLP7930F									

Symbol	Unit	Characteristics
Gain	V/V	Gain
I _{DD1}	mA	Input side supply current (V _{DD1})
I _{DD2}	mA	Output side supply current (V _{DD2})
NL ₂₀₀	%	Non linearity (±200 mV)
SNR	dB	Signal-to-noise ratio
SNDR	dB	Signal-to-(noise+distortion) Ratio
INL	LSB	Integral non-linearity
CMTI	kV/μs	Common-mode transient immunity
BVs	V _{rms}	Isolation voltage
T _{opr}	°C	Operating temperature range

► Smart IGBT Gate Driver Photocouplers

I _{OP}	t _{pLH} / t _{pHL}	Pin Assignment	Packages	Part Number	I _{CC} (mA) Max	I _{FLH} (mA) Max	CMTI (kV/μs) Min	BVs (V _{rms}) @ 1 min.	T _{opr} (°C)		Overcurrent detection	Soft shutdown	Fault output signal	Active Miller clamp	Undervoltage lockout (UVLO)	Rail-to-rail output	Dual-output
									Min	Max							
4.0 A	150 ns		SO16L	TLP5214	3.5	6	±35	5000	-40	110	✓	✓	✓	✓	✓	✓	
				TLP5214A*	3.8	6	±35	5000	-40	110	✓	✓	✓	✓	✓	✓	
1.0 A	300 ns		SO16L	TLP5231**	10.2	3.5	±25	5000	-40	110	✓	✓	✓	✓	✓	✓	✓

Symbol	Unit	Characteristics
I _{OP}	A	Output current
t _{pLH} /t _{pHL}	ns	Propagation delay time
I _{CC}	mA	Supply current
I _{FLH}	mA	Threshold input current (L/H)
CMTI	kV/μs	Common-mode transient immunity
BVs	V _{rms}	Isolation voltage
T _{opr}	°C	Operating temperature range

*: New product
**: Under Development

High-Speed Logic Photocouplers

3.3 V / 5 V Operating

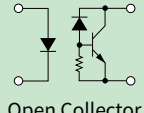
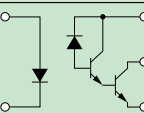
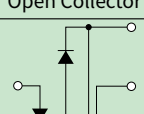
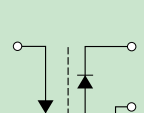
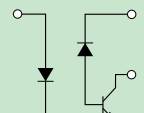
Data Rate	Output Type	Packages	Part Number	CTR (%)		t _{pLH} (μs) Max	t _{pHL} (μs) Max	BVs (Vrms) @ 1 min.	T _{opr} (°C)		
				Min	@ I _F (mA)				Min	Max	
20 kbps	 Open Collector	Analog Output	4pin SO6	TLP2301	50	1	30	30	3750	-55	125
			4pin SO6L	TLP2701	50	1	30	30	5000	-55	125
100 kbps	 Open Collector	Analog Output	5pin SO6	TLP2303	900	0.5	50	15	3750	-40	125
			SO6L	TLP2703	900	0.5	50	15	5000	-40	125
300 kbps	 Open Collector	Analog Output	SO8	TLP2403	400	0.5	60	25	3750	-40	100
1 Mbps	 Open Collector	Analog Output	5pin SO6	TLP109	20	16	0.8	0.8	3750	-55	125
				TLP2309	15	10	0.8	0.8	3750	-40	110
			SO8	TLP2409	20	16	0.8	0.8	3750	-55	125
			SDIP6	TLP719	20	16	0.8	0.8	5000	-55	100
				(F type) TLP719F							
			DIP8	TLP759	20	16	0.8	0.8	5000	-55	100
(F type) TLP759F											
Analog Output	 Open Collector	DIP8	TLP2530	7	16	1.5	1.5	2500	-55	100	
		DIP8	TLP2531	19	16	0.8	0.8	2500	-55	100	

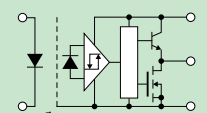
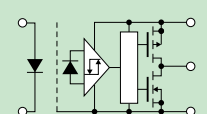
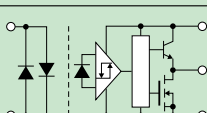
Data Rate	Output Type	Packages	Part Number	I _{cc} (mA) Max	I _{FLH} (mA) Max	I _{FHL} (mA) Max	t _{pLH} (μs) Max	BVs (Vrms) @ 1 min.	T _{opr} (°C)		
									Min	Max	
5 Mbps	 Totem Pole	Buffer Output	5pin SO6	TLP2355	3	1.6	—	0.25	3750	-40	125
			DIP8	TLP2955	3	1.6	—	0.25	5000	-40	125
				(F type) TLP2955F							
	 Totem Pole	Buffer Output	5pin SO6	TLP2310	0.3	1	—	0.25	3750	-40	125
				TLP2312*	0.5	1.6	—	0.25	3750	-40	125
			SO6L	TLP2710	0.3	1	—	0.25	5000	-40	125
				(LF4) TLP2710(LF4)*							
			SO8	TLP2110	0.6	1	—	0.25	2500	-40	125
	(LF4) TLP2210*	0.6	1.3	—	0.25	5000	-40	125			
	 Totem Pole	Buffer Output	5pin SO6	TLP2395	3	2.3	—	0.25	3750	-40	125

*: New product

Data Rate	Output Type	Packages	Part Number	I _{CC} (mA) Max	I _{FLH} (mA) Max	I _{FHL} (mA) Max	t _{PLH} (μs) Max	BVs (Vrms) @ 1 min.	T _{opr} (°C) Min	T _{opr} (°C) Max	
5 Mbps	Totem Pole	Inverter Output	5pin SO6	TLP2358	3	—	1.6	0.25	3750	-40	125
			DIP8	TLP2958	3	—	1.6	0.25	5000	-40	125
(F type)	TLP2958F										
	Totem Pole	Inverter Output	5pin SO6	TLP2398	3	—	2.3	0.25	3750	-40	125
10 Mbps	Open Collector	Digital Output	5pin SO6	TLP2362	4	—	5	0.1	3750	-40	125
				TLP2363*				0.08			105
	Totem Pole	Inverter Output	5pin SO6	TLP2391	1	—	2.3	0.1	3750	-40	125
15 Mbps	Open Collector	Digital Output	DIP8	TLP2962	4	—	5	0.075	5000	-40	125
				TLP2662	8						
	Totem Pole	Inverter Output	5pin SO6	TLP2361	1	—	1.6	0.08	3750	-40	125
				SO6L	TLP2761	1	—	1.6	0.08	5000	-40
			(LF4)	TLP2761(LF4)*							
			SO8	TLP2161	2	—	1.6	0.08	2500	-40	125
			SO8L(LF4)	TLP2261	2	—	1.6	0.08	5000	-40	125
20 Mbps	Open Collector	Digital Output	5pin SO6	TLP2368	4	—	5	0.06	3750	-40	125
			SO6L	TLP2768A	4	—	5	0.06	5000	-40	125
			(LF4)	TLP2768A(LF4)*							
			SO8	TLP2468	4	—	5	0.06	3750	-40	125
			SDIP6	TLP2768	8						
	(F type)	TLP2768F	4	—	5	0.06	5000	-40	125		
	Totem Pole	Buffer Output	5pin SO6	TLP2370	0.4	—	1	0.06	3750	-40	125
				TLP2372*	0.5		1.6				
				SO6L	TLP2770	0.4	—	1	0.06	5000	-40
				SO8L(LF4)	TLP2270	0.8	—	1	0.06	5000	-40
Totem Pole	Inverter Output	5pin SO6	TLP2366	3	—	3.5	0.055	3750	-40	125	
			SO6L	TLP2766A*	3	—	3.5	0.055	5000	-40	125
			(LF4)	TLP2766A(LF4)*							
			SO8	TLP2466	3	—	3.5	0.055	3750	-40	125
			SDIP6	TLP2766	5						
(F type)	TLP2766F	3	—	3.5	0.055	5000	-40	125			
50 Mbps	Totem Pole	Inverter Output	5pin SO6	TLP2367	2.4	—	4	0.02	3750	-40	125
			SO6L	TLP2767	2.5	—	4	0.02	5000	-40	125

*: New product

5 V Operating

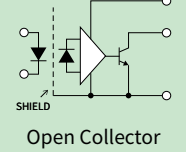
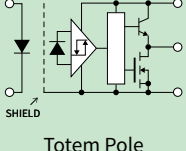
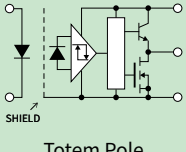
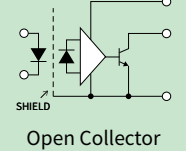
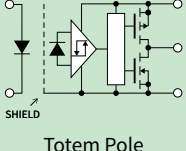
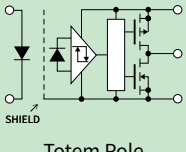
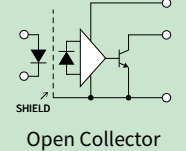
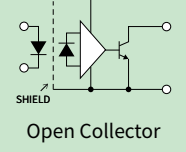
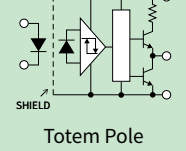
Data Rate	Output Type	Packages	Part Number	I _{cc} (mA) Max	I _{FLH} (mA) Max	I _{FHL} (mA) Max	t _{pLH} (μs) Max	BVs (Vrms) @ 1 min.	T _{opr} (°C) Min	T _{opr} (°C) Max			
1 Mbps	 Open Collector	Digital Output	5pin SO6	TLP2304*	1.3	—	5	0.55	3750	-40	125		
			SO6L (LF4)	TLP2704	1.3	—	5	0.55	5000	-40	125		
				TLP2704(LF4)									
			SO8	TLP2404	1.3	—	5	0.55	3750	-40	125		
5 Mbps	 Totem Pole	Buffer Output	SO8	TLP2405	3	1.6	—	0.25	3750	-40	100		
			SDIP6 (Type F)	TLP2105	6	1.6	—	0.25	2500	-40	100		
				TLP715	3	3	—	0.25	5000	-40	100		
	 Totem Pole	Inverter Output	SO8	TLP2408	3	—	1.6	0.25	3750	-40	100		
			SDIP6 (Type F)	TLP2108	6	—	1.6	0.25	2500	-40	100		
				TLP718	3	—	3	0.25	5000	-40	100		
10 Mbps	 Open Collector	Digital Output	DIP8	TLPN137	4	—	5	0.075	5000	-40	85		
			 Totem Pole	Buffer Output	5pin SO6	TLP2345	3	1.6	—	0.12	3750	-40	110
					SO6L (LF4)	TLP2745	3	1.6	—	0.12	5000	-40	110
	TLP2745(LF4)*												
	 Totem Pole	Inverter Output	5pin SO6	TLP2348	3	—	1.6	0.12	3750	-40	110		
			SO6L (LF4)	TLP2748	3	—	1.6	0.12	5000	-40	110		
TLP2748(LF4)*													
15 Mbps	 Open Collector	Digital Output	SO8	TLP2418	5	—	5	0.075	3750	-40	125		
				TLP2118E	10	—	5	0.075	2500	-40	100		
20 Mbps	 Open Collector	Digital Output	5pin SO6	TLP118	5	—	5	0.06	3750	-40	125		
				 Totem Pole	Inverter Output	5pin SO6	TLP116A	5	—	5	0.06	3750	-40

*: New product

Symbol	Unit	Characteristics
CTR	%	Current transfer ratio
t _{pLH} /t _{pHL}	μs	Propagation delay time
I _{cc}	mA	Supply current
I _{FLH} /I _{FHL}	mA	Threshold input current
BVs	Vrms	Isolation voltage
T _{opr}	°C	Operating temperature range

▶ IPM Interface Photocouplers

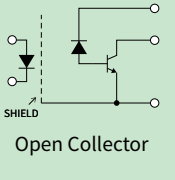
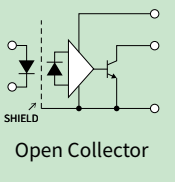
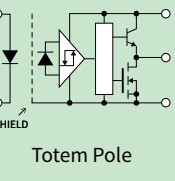
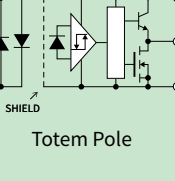
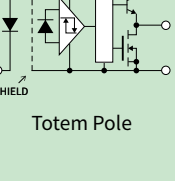
Data Rate	t_{pLH} (Max)	Output Type	Packages	Part Number	I_{CC} (mA) Max	I_{FLH} (mA) Max	I_{FHL} (mA) Max	t_{psk} (ns) Max	CMTI (kV/ μ s) Min	BVs (Vrms) @ 1 min.	T_{opr} ($^{\circ}$ C) Min	T_{opr} ($^{\circ}$ C) Max		
1 M bps	800 ns	 <p>Open Collector</p>	Analog Output	5pin SO6	TLP2309	0.001	—	—	—	± 15	3750	-40	110	
				SO6L	TLP2719*	0.001	—	—	—	± 10	5000	-40	100	
					(LF4)									TLP2719(LF4)*
				SO8	TLP2409	0.001	—	—	—	± 5	3750	-55	125	
				SDIP6	TLP719	0.001	—	—	—	± 10	5000	-55	100	
	(Type F)	TLP719F												
	550 ns	 <p>Open Collector</p>	Digital Output	5pin SO6	TLP2304*	1.3	—	5	450	± 20	3750	-40	125	
				SO6L	TLP2704	1.3	—	5	450	± 20	5000	-40	125	
					(LF4)									TLP2704(LF4)*
				SO8	TLP2404	1.3	—	5	—	± 15	3750	-40	125	
SDIP6				TLP714	1.3	—	5	450	± 20	5000	-40	125		
				(Type F)									TLP714F	
DIP8	TLP754	1.3	—	5	450	± 20	5000	-40	125					
	(Type F)									TLP754F				
5 M bps	250 ns	 <p>Totem Pole</p>	Buffer Output	5pin SO6	TLP2355	3	1.6	—	130	± 20	3750	-40	125	
				SO8	TLP2405	3	1.6	—	—	± 15	3750	-40	100	
					TLP2105									6
				SDIP6	TLP715	3	3	—	—	± 10	5000	-40	100	
					(Type F)									TLP715F
		DIP8	TLP2955	3	1.6	—	—	± 20	5000	-40	125			
		(Type F)	TLP2955F											
		5pin SO6	TLP2395	3	2.3	—	130	± 20	3750	-40	125			
		5pin SO6	 <p>Totem Pole</p>	Inverter Output	5pin SO6	TLP2358	3	—	1.6	130	± 20	3750	-40	125
					SO8	TLP2408	3	—	1.6	—	± 15	3750	-40	100
						TLP2108								
					SDIP6	TLP718	3	—	3	—	± 10	5000	-40	100
						(Type F)								
DIP8	TLP2958	3	—	1.6	—	± 20	5000	-40	125					
(Type F)	TLP2958F													
5pin SO6	 <p>Totem Pole</p>	Inverter Output	5pin SO6	TLP2398	3	—	2.3	130	± 20	3750	-40	125		

*: New product

Data Rate	t_{pLH} (Max)	Output Type	Packages	Part Number	I_{cc} (mA) Max	I_{FLH} (mA) Max	I_{FHL} (mA) Max	t_{psk} (ns) Max	CMTI (kV/ μ s) Min	BVs (Vrms) @ 1 min.	T_{opr} ($^{\circ}$ C) Min Max	
10 M bps	120 ns	Totem Pole	5pin SO6	TLP2345	3	1.6	—	70	\pm 30	3750	-40	110
			SO6L	TLP2745	3	1.6	—	70	\pm 30	5000	-40	110
			(LF4)	TLP2745(LF4)*								
	Totem Pole	5pin SO6	TLP2348	3	—	1.6	70	\pm 30	3750	-40	110	
		SO6L	TLP2748*	3	—	1.6	70	\pm 30	5000	-40	110	
		(LF4)	TLP2748(LF4)*									
100 ns	Buffer Output	SO6L	TLP2735*	4.5	3	—	60	\pm 25	5000	-40	125	

*: New product

Symbol	Unit	Characteristics
t_{pLH}/t_{pHL}	ns	Propagation delay time
I_{cc}	mA	Supply current
I_{FLH}/I_{FHL}	mA	Threshold input current
t_{psk}	ns	Propagation delay skew
CMTI	kV/ μ s	Common-mode transient immunity
BVs	Vrms	Isolation voltage
T_{opr}	$^{\circ}$ C	Operating temperature range

IGBT/MOSFET Driver Photocouplers

I_{OP} (Max)	t_{pHL} (Max)	Packages	Part Number	I_{cc} (mA) Max	I_{FLH} (mA) Max	CMTI (kV/ μ s) Min	BVs (Vrms) @ 1 min.	T_{opr} ($^{\circ}$ C) Min Max		Function Rail to Rail UVLO	
0.6 A	700 ns	SDIP6	TLP701H	2	5	\pm 20	5000	-40	125		
		(Type F)	TLP701HF								
		DIP8	TLP351H	2	5	\pm 20	3750	-40	125		
		(Type F)	TLP351HF								
	500 ns	5pin SO6	TLP151A	2	5	\pm 20	3750	-40	110		
		SO6L	TLP5701	2	5	\pm 20	5000	-40	110		✓
		(LF4)	TLP5701(LF4)								
		SO8	TLP2451A	2	5	\pm 20	3750	-40	125		
		SDIP6	TLP701A	2	5	\pm 20	5000	-40	100		
		(Type F)	TLP701AF								
		DIP8	TLP351A	2	5	\pm 20	3750	-40	100		
	(Type F)	TLP351AF									
	200 ns	5pin SO6	TLP155E	3	7.5	\pm 15	3750	-40	100		
		SDIP6	TLP705A	3	7.5	\pm 20	5000	-40	100		
(Type F)		TLP705AF									

I _{OP} (Max)	t _{pHL} (Max)	Packages	Part Number	I _{CC}	I _{FLH}	CMTI	BVs	T _{opr} (°C)		Function	
				(mA) Max	(mA) Max	(kV/μs) Min	(Vrms) @ 1 min.	Min	Max	Rail to Rail	UVLO
1.0 A	150 ns	SO6L	TLP5751	3	4	±35	5000	-40	110	✓	✓
		(LF4)	TLP5751(LF4)*								
		SO6L	TLP5771*	3	2	±35	5000	-40	110	✓	✓
		(LF4)	TLP5771(LF4)**								
2.0 A/-1.0A	380 ns	SO6L	TLP5711H**	3.5	2.5	±70	5000	-40	125	✓	✓
2.5 A	500 ns	SDIP6	TLP700H	3	5	±20	5000	-40	125		✓
		(Type F)	TLP700HF								
		DIP8	TLP250H	3	5	±40	3750	-40	125		✓
		(Type F)	TLP250HF								
	DIP8	TLP350H	3	5	±20	3750	-40	125		✓	
	(Type F)	TLP350HF									
	200 ns	SO6L	TLP5702	3	5	±20	5000	-40	110		✓
		(LF4)	TLP5702(LF4)								
		SO8L	TLP5832	3	5	±20	5000	-40	110		✓
		SDIP6	TLP700A	3	5	±20	5000	-40	110		✓
	(Type F)	TLP700AF									
	DIP8	TLP352	3	5	±20	3750	-40	125		✓	
	(Type F)	TLP352F									
	190 ns	5pin SO6	TLP152	3	7.5	±20	3750	-40	100		✓
	150 ns	SO6L	TLP5752	3	4	±35	5000	-40	110	✓	✓
		(LF4)	TLP5752(LF4)								
SO6L		TLP5772*	3	2	±35	5000	-40	110	✓	✓	
(LF4)		TLP5772(LF4)*									
4.0 A	150 ns	SO6L	TLP5754	3	4	±35	5000	-40	110	✓	✓
		(LF4)	TLP5754(LF4)								
		SO6L	TLP5774*	3	2	±35	5000	-40	110	✓	✓
		(LF4)	TLP5774(LF4)*								
6.0 A	500 ns	DIP8	TLP358	2	5	±20	3750	-40	100		✓
		(Type F)	TLP358F								
		DIP8	TLP358H	2	5	±20	3750	-40	125		✓
		(Type F)	TLP358HF								

*: New product **: Under Development

* Rail-to-rail output: An output whose voltage swings almost to the supply voltage

* Undervoltage lockout (UVLO): A feature for holding the output at the Low level until the supply voltage reaches a prescribed level.

Symbol	Unit	Characteristics
I _{OP}	A	Peak output current
t _{pLH} /t _{pHL}	ns	Propagation delay time
I _{CC}	mA	Supply current
I _{FLH} /I _{FLH}	mA	Threshold input current
CMTI	kV/μs	Common-mode transient immunity
BVs	Vrms	Isolation voltage
T _{opr}	°C	Operating temperature range

Triac Output Photocouplers

V _{DRM} (V)	Output Type	Internal Connections	Packages	Part Number	I _{FT} (mA)		V _{TM} (V)		BVs (V _{rms}) @ 1 min.	T _{opr} (°C)	
					Max	Rank	Max	@ I _{TM} (mA)		Min	Max
600 V	NZC		4pin SO6	TLP265J	10	—	2.8	70	3750	-40	100
				TLP267J	7	IFT7					
			DIP4	TLP360J	3	—	2.8	70			
				TLP360JF	2	IFT2					
			(Type F)	TLP360JF	10	—	3	100			
				TLP360JF	7	IFT7					
	5pin DIP6	TLP3052A*	10	—	3	100	5000	-40	100		
		(Type F) TLP3052AF*									
	ZC		4pin SO6	TLP266J	10	—	2.8	70	3750	-40	100
				TLP268J	7	IFT7					
			4pin MFSO6(cut)	TLP163J	3	—	2.8	70			
				TLP163J	2	IFT2					
			DIP4	TLP361J	10	—	3	100			
				TLP361JF	7	IFT7					
(Type F)			TLP361JF	10	—	3	100				
			TLP361JF	7	IFT7						
DIP4			TLP363J	10	—	3	100	5000	-40	100	
			(Type F) TLP363JF								
5pin DIP6	TLP3062A*	10	—	3	100	5000	-40	100			
	(Type F) TLP3062AF*										
5pin DIP6(cut)	TLP3064(S)	3	—	3	100	5000	-40	100			
	(Type F) TLP3064F(S)										
800 V	NZC		5pin DIP6 TLP3073*	5	—	3	100	5000	-40	100	
			(Type F) TLP3073F*								
	ZC		5pin DIP6 TLP3083*	5	—	3	100	5000	-40	100	
			(Type F) TLP3083F*								

NZC: Non Zero Cross
ZC: Zero Cross

*: New product

Symbol	Unit	Characteristics
V _{DRM}	V	Off-state output terminal voltage
I _{FT}	mA	Trigger LED current
V _{TM}	V	Peak on-state voltage
BVs	V _{rms}	Isolation voltage
T _{opr}	°C	Operating temperature range

Product for Japan

V _{DRM} (V)	Output Type	Internal Connections	Packages	Part Number	I _{FT} (mA)		V _{TM} (V)		BV _s (V _{rms}) @ 1 min.	T _{opr} (°C)	
					Max	Rank	Max	@ I _{TM} (mA)		Min	Max
600 V	ZC		5pin DIP6(cut)	TLP663J(S)	10	—	3	100	5000	-40	100
			(Type F)	TLP663JF(S)							
			5pin DIP6(cut)	TLP668J(S)	10	—	3	100	5000	-40	100
			(Type F)	TLP668JF(S)							
800 V	ZC		5pin DIP6(cut)	TLP669L(S)	10	—	3	100	5000	-40	100
					5	IFT5					
			(Type F)	TLP669LF(S)	10	—	3	100	5000		
					5	IFT5					

Thyristor Output Photocouplers

V _{DRM} (V)	Internal Connections	Packages	Part Number	I _{FT} (mA) Max	V _{TM} (V)		BV _s (V _{rms}) @ 1 min.	T _{opr} (°C)	
					Max	@ I _{TM} (mA)		Min	Max
400V		5pin MFSOP6	TLP148G	10	1.45	100	2500	-40	100
600V		DIP6	TLP548J	7	1.45	100	2500	-40	100
		DIP6	TLP748J	10	1.45	100	4000	-40	100
		(Type F)	TLP748JF	10	1.45	100	4000	-40	100
		7pin DIP8	TLP549J	7	1.45	100	2500	-40	100

Symbol	Unit	Characteristics
V _{DRM}	V	Peak forward voltage
I _{FT}	mA	Trigger LED current
V _{TM}	V	On-state voltage
BV _s	V _{rms}	Isolation voltage
T _{opr}	°C	Operating temperature range

Transistor-Output Photocouplers

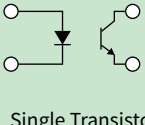
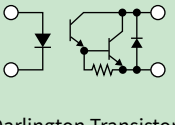
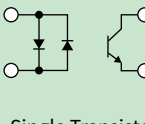
Input Type	Internal Connections	Features	Packages	Part Number	CTR (%)					V _{CEO} (V)	BV _s (V _{rms}) @ 1 min.	T _{opr} (°C)	
					Min	Max	@ I _F (mA)	@ V _{CE} (V)	Rank			Min	Max
DC Input	 Single Transistor	General-Purpose	SO4	TLP291(SE)	50	600	5	5	☆ 1	80	3750	-55	110
			SO16	TLP291-4	50	400	5	5	☆ 4	80	2500	-55	110
			4pin SO6	TLP185(SE)	50	600	5	5	☆ 1	80	3750	-55	110
			4pin SO6L	TLP385	50	600	5	5	☆ 1	80	5000	-55	110
			DIP4	TLP785	50	600	5	5	☆ 1	80	5000	-55	110
			(F Type)	TLP785F	50	600	5	5	☆ 1	80	5000	-55	110
			SO4	TLP293	50	600	0.5	5	☆ 1	80	3750	-55	125
		Low Input Current	SO16	TLP293-4	50	600	0.5	5	☆ 5	80	3750	-55	125
			4pin SO6	TLP183	50	600	0.5	5	☆ 1	80	3750	-55	125
			4pin SO6L	TLP383	50	600	0.5	5	☆ 1	80	5000	-55	125
		High-V _{CEO}	4pin SO6	TLP188	50	600	5	5	☆ 3	350	3750	-55	110
			4pin SO6L	TLP388	50	600	5	5	☆ 3	350	5000	-55	125
			DIP4	TLP628M*	50	600	5	5	☆ 3	350	5000	-55	125
		(F Type)	TLP628MF*	50	600	5	5	☆ 3	350	5000	-55	125	
High-V _{CEO}	 Darlington Transistor	4pin SO6	TLP187	1000	—	1	1	—	300	3750	-55	110	
		4pin SO6L	TLP387	1000	—	1	1	—	300	5000	-55	110	
		DIP4	TLP627M*	1000	—	1	1	—	300	5000	-55	110	
		(F Type)	TLP627MF*	1000	—	1	1	—	300	5000	-55	110	
AC Input	 Single Transistor	General-Purpose	SO4	TLP290(SE)	50	600	±5	5	☆ 2	80	3750	-55	110
			SO16	TLP290-4	50	400	±5	5	☆ 4	80	2500	-55	110
			4pin SO6	TLP184(SE)	50	600	±5	5	☆ 2	80	3750	-55	110
		Low Input Current	SO4	TLP292	50	600	±0.5	5	☆ 2	80	3750	-55	125
			SO16	TLP292-4	50	600	±0.5	5	☆ 5	80	3750	-55	125
			4pin SO6	TLP182	50	600	±0.5	5	☆ 2	80	3750	-55	125
			DIP4	TLP620M*	50	600	0.5	5	☆ 2	80	5000	-55	125
			(F Type)	TLP620MF*	50	600	0.5	5	☆ 2	80	5000	-55	125

*: New product

Current Transfer Ratio Rank

Different photocouplers are available with different CTR ranks.

Current Transfer Ratio Rank

Rank Name	CTR (%)		CTR (%)						Relevant Part	
	Min	Max	50	100	200	300	400	500		600
Blank	50	600	-----						☆ 1 ☆ 2 ☆ 3	
	50	400	-----							☆ 4
Y	50	150	-----							☆ 1 ☆ 2
YH	75	150	-----							☆ 1
GR	100	300	-----							☆ 1 ☆ 2
GRL	100	200	-----							☆ 1
GRH	150	300	-----							☆ 1
GB	100	600	-----						☆ 1 ☆ 2 ☆ 3	
	100	400	-----							☆ 4
BL	200	600	-----							☆ 1 ☆ 2
BLL	200	400	-----							☆ 1
LA ^(Note)	50	600	-----						☆ 5	
LGB ^(Note)	100	600	-----						☆ 5	

Note: LA and LGB are CTR ranks in the low-input-current region.

Symbol	Unit	Characteristics
CTR	%	Current Transfer Ratio
I _F	mA	Input forward current
V _{CEO}	V	Collector-emitter voltage
BV _s	V _{rms}	Isolation voltage
T _{opr}	°C	Operating temperature range

▶ Photovoltaic Output Photocouplers

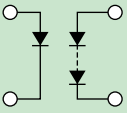
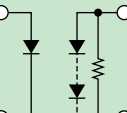
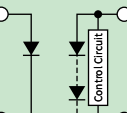
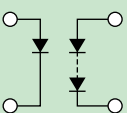
Voc Min	Internal Connections	Packages	Part Number	Min	Isc (μ A)		BVs (Vrms) @ 1 min.	T _{opr} (°C)		
					@ I _F (mA)	Rank		Min	Max	
7 V		SSOP4	TLP3904	5	10	–	1500	–40	85	
			TLP3914	20	10	–	1500	–40	85	
		4pin MFSOP6	TLP3902	5	10	–	2500	–40	85	
			TLP190B	12	10	–	2500	–40	85	
				20	10	C20				
		4pin SO6	TLP3905	12	10	–	3750	–40	125	
				20	10	C20				
	5pin DIP6(cut)	TLP590B	12	10	–	2500	–40	85		
				20	10				C20	
	Built-in shunt resistor		4pin MFSOP6	TLP191B	24	20	–	2500	–40	85
5pin DIP6(cut)			TLP591B	24	20	–	2500	–40	85	
Built-in discharging circuit			4pin SO6	TLP3906	12	10	–	3750	–40	125
					20	10	C20			
30 V		SSOP4	TLP3924	4	10	–	1500	–40	85	

Note: Some photocouplers are available with the C20 short-circuit rank.

Rank	I _{sc} (μ A) min
None	12
C20	20

Symbol	Unit	Characteristics
V _{oc}	V	Open voltage
I _{sc}	μ A	Short-circuit Current
I _F	mA	Input forward current
BVs	Vrms	Isolation voltage
T _{opr}	°C	Operating temperature range

Photorelays

1-Form-A (Ultra-Small Leadless Packages)

(1/4)

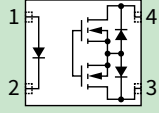
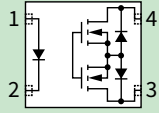
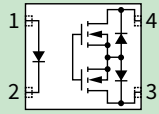
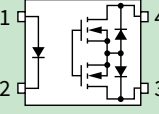
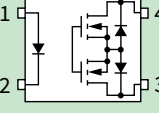
Packages	Pin Assignment	V _{OFF} (V) Min	I _{ON} (A) Max	Part Number	R _{ON} (Ω)		I _{FT} (mA) Max	C _{OFF} (pF) Typ.	BVs (V _{rms}) @ 1 min.	T _{opr} (°C)		
					Max	@ I _F (mA)				Min	Max	
S-VSON4T		40	±0.12	TLP3440S*	14	5	3	0.45	500	-40	110	
S-VSON4		30	±1.5	TLP3406S*	0.2	5	3	120	500	-40	110	
		60	±0.4	TLP3475S*	1.5	5	3	12	500	-40	110	
			±1	TLP3407S*	0.3	5	3	80	500	-40	110	
		100	±0.65	TLP3409S*	0.6	5	3	50	500	-40	110	
VSON4		20	±0.20	TLP3450*	5	5	3	0.8	500	-40	110	
			±0.45	TLP3431*	1.2	5	3	5	500	-40	110	
			±1	TLP3403*	0.22	5	3	40	500	-40	110	
		40	±0.1	TLP3442*	20	5	3	0.3	500	-40	110	
			±0.12	TLP3440*	14	5	3	0.45	500	-40	110	
			±0.14	TLP3441*	10	5	3	0.7	500	-40	110	
			±0.25	TLP3414*	3	5	3	5	500	-40	110	
		50	±0.3	TLP3475*	1.5	5	3	12	500	-40	110	
		60	±0.12	TLP3451*	15	5	3	0.7	500	-40	110	
			±0.4	TLP3412*	1.5	5	3	20	500	-40	110	
		80	±0.12	TLP3417*	12	5	3	5	500	-40	110	
			±0.2	TLP3419*	8	5	3	6.5	500	-40	110	
		100	±0.1	TLP3420*	14	5	3	6	500	-40	110	
		P-SON4		30	± 4.5	TLP3480**	0.05	5	3	450	500	-40
60	± 3.0			TLP3481**	0.1	5	3	250	500	-40	110	
100	± 2.0			TLP3482**	0.2	5	3	170	500	-40	110	
200	± 0.35			TLP3483**	8	5	3	75	500	-40	110	
400	± 0.18			TLP3484**	35	5	3	60	500	-40	110	
USOP4		20	±0.16	TLP3330	8	5	3	1	1000	-40	85	
			±0.2	TLP3350	5	5	3	0.8	1000	-40	85	
			±0.9	TLP3303	0.22	5	3	40	1000	-40	85	
		40	±0.1	TLP3342	20	5	3	0.3	1000	-40	85	
			±0.12	TLP3340	14	5	3	0.45	1000	-40	85	
			±0.14	TLP3341	10	5	3	0.7	1000	-40	85	
			±0.3	TLP3315	1.5	5	3	10	1000	-40	85	
		50	±0.3	TLP3375	1.5	5	3	12	1000	-40	85	
		60	±0.12	TLP3351	15	5	3	0.7	1000	-40	85	
			±0.4	TLP3312	1.5	5	3	20	1000	-40	85	
		75	±0.4	TLP3306	1.5	5	3	30	1000	-40	85	
			80	±0.12	TLP3317	12	5	3	5	1000	-40	85
				±0.2	TLP3319	8	5	3	6.5	1000	-40	85
		100	±0.1	TLP3320	14	5	3	6	1000	-40	85	
		SSOP4		20	±0.16	TLP3230	8	5	4	1	1500	-20
±0.2	TLP3250				5	5	3	0.8	1500	-20	85	
±0.45	TLP3231				1.2	5	4	5	1500	-20	85	
±0.9	TLP3203				0.22	5	3	40	1500	-20	85	
40	±0.12			TLP3216	15	5	4	1	1500	-20	85	
	±0.12			TLP3240	14	5	3	0.45	1500	-20	85	
	±0.14			TLP3241	10	5	3	0.7	1500	-20	85	
	±0.25			TLP3214	3	5	4	5	1500	-20	85	
	±0.3			TLP3215	1.5	5	4	10	1500	-20	85	
50	±0.3			TLP3275	1.5	5	3	12	1500	-20	85	
60	±0.4			TLP3212	1.5	5	5	20	1500	-20	85	
80	±0.12			TLP3217	12	5	5	5	1500	-20	85	
100	±0.08			TLP3220	14	10	5	6	1500	-20	85	

*: New product

** : Under Development

1-Form-A (Ultra-Small Leadless Packages)

(2/4)

Packages	Pin Assignment	V _{OFF} (V) Min	I _{ON} (A) Max	Part Number	R _{ON} (Ω)		V _{FON} (V) Max	C _{OFF} (pF) Typ.	BV _s (V _{rms}) @ 1 min.	T _{opr} (°C)	
					Max	@ V _{IN} (V)				Min	Max
S-VSON4T		30	±1.5	TLP3406SRH*	0.2	5	3	120	500	-40	110
		30	±1.5	TLP3406SRL*	0.2	2	1.6	120	500	-40	110
		60	±0.4	TLP3412SRH*	1.5	5	3	—	500	-40	110
		60	±1.0	TLP3407SRH*	0.3	5	3	80	500	-40	110
		60	±1.0	TLP3407SRL*	0.3	2	1.6	80	500	-40	110
VSONR4		20	±1.0	TLP3403R	0.22	5	3	40	500	-40	110
		50	±0.3	TLP3475R	1.5	5	3	12	500	-40	110
		60	±0.4	TLP3412R	1.5	5	3	20	500	-40	110

1-Form-A (Surface-Mount Packages)

(3/4)

Packages	Pin Assignment	V _{OFF} (V) Min	I _{ON} (A) Max	Part Number	R _{ON} (Ω)		I _{FT} (mA) Max	C _{OFF} (pF) Typ.	BV _s (V _{rms}) @ 1 min.	T _{opr} (°C)				
					Max	@ I _F (mA)				Min	Max			
4pin SO6		60	±0.1	TLP175A	50	2	1	10	3750	-40	85			
			±0.5	TLP172AM*	2	5	3	20	3750	-40	110			
			±0.7	TLP176AM*	2	5	3	100	3750	-40	110			
			±1.4	TLP3122A*	0.25	5	3	100	3750	-40	110			
			±0.11	TLP172GM*	50	5	3	30	3750	-40	110			
2.54SOP4		30	±0.11	TLP172GM*	50	5	3	30	3750	-40	110			
			±0.11	TLP172GM*	65	5	3	30	3750	-40	110			
			40	±3.3	TLP3146*	0.05	5	3	450	1500	-40	110		
				±1	TLP3123	0.13	5	3	300	1500	-40	85		
			60	±0.4	TLP170A	2	2	1	130	1500	-40	85		
				±0.4	TLP171A	2	0.5	0.2	130	1500	-40	85		
				±1	TLP3122	0.7	5	3	90	1500	-40	85		
				±1.7	TLP3127	0.13	5	3	250	1500	-40	85		
			100	±2.5	TLP3147*	0.1	5	3	240	1500	-40	110		
				±1.5	TLP3149*	0.2	5	3	160	1500	-40	110		
			200	±0.05	TLP179D	50	5	3	15	1500	-40	85		
				±0.2	TLP170D	8	2	1	90	1500	-40	85		
				±0.2	TLP171D	8	0.5	0.2	90	1500	-40	85		
				±0.2	TLP176D	8	5	3	100	1500	-40	85		
				±0.4	TLP3145	2	5	3	100	1500	-40	110		
				350	±0.1	TLP170G	50	2	1	35	1500	-40	85	
					±0.12	TLP174G	35	5	3	70	1500	-40	85	
				400	±0.12	TLP176G	35	5	3	40	1500	-40	85	
					±0.1	TLP171GA	35	0.5	0.2	70	1500	-40	85	
				600	±0.12	TLP174GA	35	5	3	70	1500	-40	85	
			±0.2		TLP176GA	35	5	3	70	1500	-40	85		
			2.54SOP6		20	±0.12	TLP174G	35	5	3	70	1500	-40	85
						±0.12	TLP176G	35	5	3	40	1500	-40	85
						±0.1	TLP171GA	35	0.5	0.2	70	1500	-40	85
						±0.12	TLP174GA	35	5	3	70	1500	-40	85
						±0.2	TLP176GA	35	5	3	70	1500	-40	85
350	±0.07	TLP171J				60	0.5	0.2	75	1500	-40	85		
	±0.09	TLP170J				60	2	1	75	1500	-40	85		
400	±0.05	TLP199D				50	5	3	15	1500	-40	85		
	±0.11	TLP192G				50	5	3	30	1500	-40	85		
	±0.12	TLP197G				35	5	3	40	1500	-40	85		
	±0.12	TLP197GA				35	5	3	70	1500	-40	85		
	±2.5	TLP3100				0.05	5	3	1000	1500	-40	85		
	±4.5	TLP3106A*				0.03	5	3	1200	1500	-40	110		
	±4	TLP3106*				0.04	5	3	1100	1500	-40	85		
	±2.5	TLP3102				0.06	5	3	1000	1500	-40	85		
	±0.4	TLP192A				2	5	3	130	1500	-40	85		
	±2.3	TLP3103				0.07	5	3	1000	1500	-40	85		
	±3.3	TLP3107				0.06	5	3	700	1500	-40	85		
	±4	TLP3107A*	0.04	5	3	750	1500	-40	110					
±1.4	TLP3105	0.2	5	3	1000	1500	-40	85						
±2	TLP3109*	0.07	5	3	500	1500	-40	85						
±3	TLP3109A*	0.065	5	3	460	1500	-40	110						

*: New product **: Under Development

Symbol	Unit	Characteristics
V _{OFF}	V	OFF-state output terminal voltage
I _{ON}	A	ON-state current
R _{ON}	Ω	On-state resistance
I _F	mA	Input forward current
I _{FT}	mA	Trigger LED current
C _{OFF}	pF	Output capacitance
BV _s	V _{rms}	Isolation voltage
T _{opr}	°C	Operating temperature range
V _{IN}	V	Applied input forward voltage
V _{FON}	V	Operating voltage

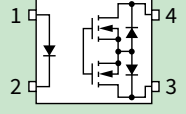
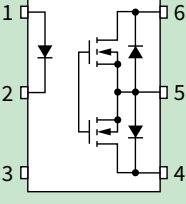
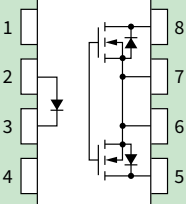
Packages	Pin Assignment	V _{OFF} (V) Min	I _{ON} (A) Max	Part Number	R _{ON} (Ω)		I _{FT} (mA) Max	C _{OFF} (pF) Typ.	BV _s (V _{rms}) @ 1 min.	T _{opr} (°C)	
					Max	@ I _F (mA)				Min	Max
DIP4		20	±3	TLP3553	0.08	5	3	300	2500	-40	85
		30	±4	TLP3553A*	0.05	5	3	160	2500	-40	110
		40	±2	TLP241A*	0.15	5	3	300	5000	-40	85
				TLP241AF*							
			±2.5	TLP3554	0.15	5	3	300	2500	-40	85
				TLP222A							
			±0.5	TLP240A	2	5	3	130	5000	-40	85
				TLP240AF							
			±2	TLP3555	0.2	5	3	250	2500	-40	85
				TLP3555A*							
			±3	TLP3556	0.1	5	3	250	2500	-40	110
				TLP3556A*							
			±1	TLP3558A*	0.7	5	3	200	2500	-40	85
				TLP3558A*							
			±2	TLP240D	2	5	3	110	2500	-40	110
				TLP240DF							
			±0.7	TLP240J	8	5	3	80	5000	-40	85
				TLP240JF							
			±0.25	TLP222D	8	5	3	100	2500	-40	85
				TLP222D							
	±0.3	TLP240G	50	5	3	30	5000	-40	85		
		TLP240GF									
	±0.1	TLP222G	50	5	3	30	2500	-40	85		
		TLP222G									
	±0.12	TLP224G	35	5	3	40	2500	-40	85		
		TLP224G									
	±0.12	TLP228G	50	5	3	30	2500	-40	85		
		TLP228G									
	±0.12	TLP224GA	35	5	3	70	2500	-40	85		
		TLP224GA									
	±0.12	TLP240GA	35	5	3	80	5000	-40	85		
		TLP240GAF									
	±0.12	TLP240J	60	5	3	75	5000	-40	85		
		TLP240JF									
	±0.09	TLP240J	60	5	3	75	5000	-40	85		
		TLP240JF									
DIP6		20	±4	TLP3543	0.05	5	3	1000	2500	-40	85
		30	±5	TLP3543A*	0.04	5	3	1100	2500	-40	110
		40	±3.5	TLP3544	0.06	5	3	1000	2500	-40	85
		60	±0.5	TLP592A	2	5	3	130	2500	-40	85
				TLP597A							
				TLP598AA							
				TLP598AA							
			±2.5	TLP3542	0.065	10	3	400	2500	-20	85
				TLP3542							
			±3	TLP3545	0.07	5	3	1000	2500	-40	85
				TLP3545							
			±4	TLP3545A*	0.06	5	3	640	2500	-40	110
				TLP3545A*							
			±2	TLP3546	0.2	5	3	1000	2500	-40	85
				TLP3546							
			±3.5	TLP3546A*	0.08	5	3	450	2500	-40	110
				TLP3546A*							
			±0.12	TLP592G	50	5	3	30	2500	-40	85
				TLP592G							
			±0.12	TLP597G	35	5	3	40	2500	-40	85
TLP597G											
	±0.12	TLP597GA	35	5	3	70	2500	-40	85		
		TLP597GA									
	±0.12	TLP797GA	35	5	3	70	5000	-40	85		
		TLP797GAF									
	±0.15	TLP598GA	12	5	3	-	2500	-40	85		
		TLP598GA									
	±0.15	TLP798GA	12	5	5	-	5000	-40	85		
		TLP798GA									
	±0.1	TLP797J	45	10	5	120	5000	-40	85		
		TLP797JF									
DIP8		60	±5	TLP3547	0.05	5	5	850	2500	-40	85
		100	±3	TLP3823	0.15	5	5	720	2500	-40	110
		200	±1.5	TLP3825	0.5	5	5	400	2500	-40	110
		400	±0.4	TLP3548	5	2	1	410	2500	-40	85
		600	±0.6	TLP3549	2	5	5	4300	2500	-40	85

*: New product

2-Form-A

Packages	Pin Assignment	V _{OFF} (V) Min	I _{ON} (A) Max	Part Number	R _{ON} (Ω)		I _{FT} (mA) Max	C _{OFF} (pF) Typ.	BV _s (V _{rms}) @ 1 min.	T _{opr} (°C)			
					Max	@ I _F (mA)				Min	Max		
2.54SOP8		60	±0.4	TLP202A	2	5	3	130	1500	-40	85		
				TLP206A	2	5	3	140	1500	-40	85		
		200	±0.2	TLP200D	8	5	3	100	1500	-40	85		
				350	±0.11	TLP202G	50	5	3	30	1500	-40	85
						±0.12	TLP206G	35	5	3	40	1500	-40
400	±0.12	TLP206GA	35	5	3	70	1500	-40	85				
DIP8		60	±0.5	TLP222A-2	2	5	3	130	2500	-40	85		
				TLP222G-2	50	5	3	30	2500	-40	85		
		350	±0.12	TLP224G-2	35	5	3	40	2500	-40	85		
				TLP228G-2	50	5	3	30	2500	-40	85		
				TLP224GA-2	35	5	3	70	2500	-40	85		

1-Form-B

Packages	Pin Assignment	V _{OFF} (V) Min	I _{ON} (A) Max	Part Number	R _{ON} (Ω)		I _{FC} (mA) Max	C _{OFF} (pF) Typ.	BV _s (V _{rms}) @ 1 min.	T _{opr} (°C)	
					Max	@ I _F (mA)				Min	Max
2.54SOP4		60	±0.5	TLP4176A*	2.5	0	3	100	1500	-40	105
				TLP4176G	25	0	3	65	1500	-40	85
DIP4		350	±0.15	TLP4227G	25	0	3	65	2500	-40	85
2.54SOP6		350	±0.12	TLP4197G	25	0	3	65	1500	-40	85
DIP6					350	±0.15	TLP4597G	25	0	3	65

2-Form-B

Packages	Pin Assignment	V _{OFF} (V) Min	I _{ON} (A) Max	Part Number	R _{ON} (Ω)		I _{FC} (mA) Max	C _{OFF} (pF) Typ.	BV _s (V _{rms}) @ 1 min.	T _{opr} (°C)	
					Max	@ I _F (mA)				Min	Max
2.54SOP8		350	±0.12	TLP4206G	25	0	3	65	1500	-40	85
DIP8					350	±0.15	TLP4227G-2	25	0	3	65

1-Form-A, 1-Form-B

Packages	Pin Assignment	V _{OFF} (V) Min	I _{ON} (A) Max	Part Number	R _{ON} (Ω)		I _{FT} /I _{FC} (mA) Max	C _{OFF} (pF) Typ.	BV _s (V _{rms}) @ 1 min.	T _{opr} (°C)	
					Max	@ I _F (mA)				Min	Max
2.54SOP8		350	±0.12	TLP4206G	25	5/0	3	65	1500	-40	85
DIP8					350	±0.12	TLP4006G	25	5/0	3	65

▶ Photocouplers for Automotive

High-Speed Logic Photocouplers

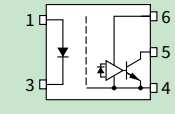
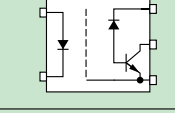
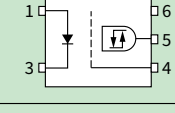
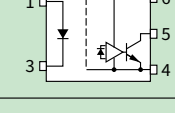
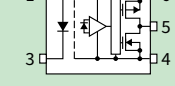
Data Rate	Output Form	Output Type	Packages	Part Number	I _{CC} (mA) Max	I _{FLH} (mA) Max	I _{FHL} (mA) Max	t _{pLH} (ns) Max	t _{pHL} (ns) Max	BV _s (Vrms) @ 1 min.	T _{opr} (°C)		
											Min	Max	
1 Mbps	OC	Digital		5pin SO6	TLX9304	1.3	—	5	550	400	3750	-40	125
1 Mbps	OC	Analog		5pin SO6	TLX9309	0.001	—	—	1200	1000	3750	-40	125
5 Mbps	TP	BUF		5pin SO6	TLX9310	0.3	1	—	250	250	3750	-40	105
10 Mbps	OC	Digital		5pin SO6	TLX9378	1.3	—	5	100	100	3750	-40	125
20 Mbps	TP	INV		5pin SO6	TLX9376	1.7	—	4	35	35	3750	-40	125

OC: Open Collector Output
TP: Totem Pole Output

INV: Inverter Logic Output
BUF: Buffer Logic Output

Transistor-Output Photocouplers

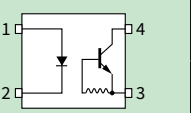
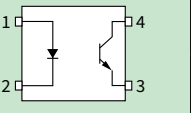
Input Type	Internal Connections	Packages	Part Number	CTR (%) @ Ta = 25 °C				V _{CEO} (V)	BV _s (Vrms) @ 1 min.	T _{opr} (°C)	
				Min	Max	@ I _F (mA)	@ V _{CE} (V)			Min	Max
DC Input		SO4	TLX9000	100	900	5	5	40	3750	-40	125
		4pin SO6	TLX9300	100	900	5	5	40	3750	-40	125
		SO4	TLX9291A	50	600	5	5	80	3750	-40	125
		4pin SO6	TLX9185A	50	600	5	5	80	3750	-40	125

Photovoltaic Output Photocouplers

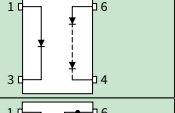
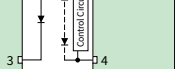
Discharging Circuit	Internal Connections	Packages	Part Number	I _{sc} (mA)		V _{oc} (mA)		BV _s (Vrms) @ 1 min.	T _{opr} (°C)	
				Min	@ I _F (mA)	Min	@ I _F (mA)		Min	Max
N		4pin SO6	TLX9905	12	10	7	10	3750	-40	125
Y		4pin SO6	TLX9906	12	10	7	10	3750	-40	125

Photorelays 1-Form-A

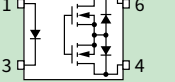
Packages	Pin Assignment	V _{OFF} (V) Min	I _{ON} (mA) Max	Part Number	Max	R _{ON} (Ω)		I _{FT} (mA) Max	C _{OFF} (pF) Typ.	BV _s (Vrms) @ 1 min.	T _{opr} (°C)	
						@ I _F (mA)	@ I _{ON} (mA)				Min	Max
4pin SO6		600	15	TLX9175J	335	10	15	3	8	3750	-55	105

Part Number Index / Safety Standards

■ Part Number Index

The part number index is arranged in the order of part numbers.

■ Safety Standards

The part number index shows the status of certification for the overseas safety standards.

The ○ mark denotes “Certified,” whereas the △ mark signifies “Pending” (as of March 2020).

○	Standard Certification
△	Pending

The meanings of the abbreviations used in the part number index are as follows.

Abbreviation	Safety Standard	Country/Area	Certification Body	Standard Category
UL	UL 1577	U.S. /North America	Underwriters Laboratories Inc.	Parts standard
cUL	CA 5A (cUL ^{*1})	Canada /North America	Canadian Standards Association	
VDE1	EN 60747-5-5	Germany /Europe	Verband Deutscher Elektrotechnischer e.V.	Equipment standard
VDE2	EN 60950-1 EN 60065 EN 62368 ^{*2}			
CQC	GB4943 (IEC 60950-1 MOD ^{*3}) GB8898 (IEC 60065 MOD ^{*3})	China	China Quality Certification center	

*1: The United States and Canada have a mutual recognition agreement. UL products certified for Canada are also recognized for conformance to CSA under a mutual recognition agreement and can bear the cUL mark. Toshiba's cUL-recognized photocouplers for the Canadian market are certified under UL1577, but not UL508.

*2: The EN 60950-1- and EN 60065-certified photocouplers will be re-certified under EN 62368-1, a replacement for the EN 60950-1 and EN 60065 standards.

*3: The “MOD” suffix denotes a Chinese version modified based on the IEC standard.

The ○ mark denotes "Certified," whereas the △ mark signifies "Pending" (as of March 2020).

Photocouplers	Safety Standards					Page
	UL1577	cUL	VDE1	VDE2	CQC	
TLP1xx						
TLP104	○	○	○	○	○	11, 39
TLP109	○	○	○	○	○	9, 36
TLP116A	○	○	○	○	○	9, 38
TLP118	○	○	○	○	○	9, 38
TLP148G	○	○				15, 43
TLP151A	○	○	○	○		13, 40
TLP152	○	○	○	○	○	13, 41
TLP155E	○	○	○	○	○	13, 40
TLP163J	○	○				14, 42
TLP182	○	○	○	○	○	17, 44
TLP183	○	○	○	○	○	17, 44
TLP184(SE)	○	○	○	○	○	17, 44
TLP185(SE)	○	○	○	○	○	17, 44
TLP187	○	○	○	○	○	17, 44
TLP188	○	○	○	○	○	17, 44
TLP190B	○	○				18, 45
TLP191B	○	○				18, 45
TLP2xx						
TLP250H TLP250HF	○	○	○	○		13, 41
TLP265J	○	○	○	○	○	14, 42
TLP266J	○	○	○	○	○	14, 42
TLP267J	○	○	○	○	○	14, 42
TLP268J	○	○	○	○	○	14, 42
TLP290(SE)	○	○	○	○	○	17, 44
TLP290-4	○	○	○		○	17, 44
TLP291(SE)	○	○	○	○	○	17, 44
TLP291-4	○	○	○		○	17, 44
TLP292	○	○	○	○	○	17, 44
TLP292-4	○	○	○	○	○	17, 44
TLP293	○	○	○	○	○	17, 44
TLP293-4	○	○	○	○	○	17, 44
TLP3xx						
TLP350H TLP350HF	○	○	○	○	○	13, 41
TLP351A TLP351AF	○	○	○	○		13, 40
TLP351H TLP351HF	○	○	○	○	○	13, 40
TLP352 TLP352F	○	○	○	○	○	13, 41
TLP358 TLP358F	○	○	○	○		13, 41
TLP358H TLP358HF	○	○	○	○	○	13, 41
TLP360J TLP360JF	○	○	○	○	○	14, 42
TLP361J TLP361JF	○	○	○	○	○	14, 42
TLP363J TLP363JF	○	○	○	○	○	14, 42
TLP383	○	○	○	○	○	17, 44
TLP385	○	○	○	○	○	17, 44
TLP387	○	○	○	○	○	17, 44
TLP388	○	○	○	○	○	17, 44
TLP5xx						
TLP548J	○					15, 43
TLP549J	○					15, 43
TLP590B	○					18, 45
TLP591B	○					18, 45

Photocouplers	Safety Standards					Page
	UL1577	cUL	VDE1	VDE2	CQC	
TLP6xx						
TLP620M TLP620MF	○	○	○	○	○	17, 44
TLP627M TLP627MF	○	○	○	○	○	17, 44
TLP628M TLP628MF	○	○	○	○	○	17, 44
TLP663J(S) TLP633JF(S)	○	○	○	○	○	14, 43
TLP668J(S) TLP668JF(S)	○	○	○	○	○	14, 43
TLP669L(S) TLP669LF(S)	○	○	○	○	○	14, 43
TLP7xx						
TLP700A TLP700AF	○	○	○		○	13, 41
TLP700H TLP700HF	○	○	○			13, 40
TLP701A TLP701AF	○	○	○			13, 40
TLP701H TLP701HF	○	○	○			13, 41
TLP705A TLP705AF	○	○	○			13, 40
TLP714 TLP714F	○	○	○			11, 39
TLP715 TLP715F	○	○	○			9, 11, 38, 39
TLP718 TLP718F	○	○	○			9, 11, 38, 39
TLP719 TLP719F	○	○	○			9, 11, 36, 39
TLP748J RTP748JF	○	○	○			15, 43
TLP754 TLP754F	○	○	○	○		11, 39
TLP759 TLP759F	○	○	○			9, 36
TLP785 TLP785F	○	○	○		○	17, 44
TLP21xx						
TLP2105	○	○	○			9, 11, 38, 39
TLP2108	○	○	○			9, 11, 38, 39
TLP2110	○	○	○			9, 36
TLP2118E	○	○	○			9, 38
TLP2160	○	○	○			9, 37
TLP2161	○	○	○			9, 37
TLP2168	○	○	○			9, 37
TLP22xx						
TLP2210	○	○	○		△	9, 36
TLP2261	○	○	○	○	○	9, 37
TLP2270	○	○	○	○	○	9, 37
TLP23xx						
TLP2301	○	○	○	○	○	9, 36
TLP2303	○	○	○	○	○	9, 36
TLP2309	○	○	○	○	○	9, 11, 36, 39
TLP2310	○	○	○	○	○	9, 36
TLP2312	○	○	○		△	9, 36
TLP2345	○	○	○	○		9, 11, 38, 40
TLP2348	○	○	○	○		9, 11, 38, 40
TLP2355	○	○	○	○	○	9, 11, 36, 39
TLP2358	○	○	○	○	○	9, 11, 37, 39

The ○ mark denotes "Certified," whereas the △ mark signifies "Pending" (as of March 2020).

Photocouplers	Safety Standards					Page
	UL1577	cUL	VDE1	VDE2	CQC	
TLP2361	○	○	○	○	○	9, 37
TLP2362	○	○	○	○	○	9, 37
TLP2363	○	○	○		△	9, 37
TLP2366	○	○	○	○	○	9, 37
TLP2367	○	○	○		○	9, 37
TLP2368	○	○	○	○	○	9, 37
TLP2370	○	○	○	○	○	9, 37
TLP2372	○	○	○		△	9, 37
TLP2391	○	○	○	○	○	9, 37
TLP2395	○	○	○	○	○	9, 11, 36, 39
TLP2398	○	○	○	○	○	9, 11, 37, 39
TLP24xx						
TLP2403	○	○	○			9, 36
TLP2404	○	○	○			11, 39
TLP2405	○	○	○			9, 11, 38, 39
TLP2408	○	○	○			9, 11, 38, 39
TLP2409	○	○	○			9, 11, 36, 39
TLP2418	○	○	○			9, 38
TLP2451A	○	○	○			13, 40
TLP2466	○	○	○			9, 37
TLP2468	○	○	○			9, 37
TLP25xx						
TLP2530	○	○				9, 36
TLP2531	○	○				9, 36
TLP26xx						
TLP2662						
TLP2662F	○	○	○	○		9, 37
TLP27xx						
TLP2701	○	○	○	○	○	9, 36
TLP2703	○	○	○	○	○	9, 36
TLP2704	○	○	○	○	○	9, 11, 38, 39
TLP2704(LF4)						
TLP2710	○	○	○	○	○	9, 36
TLP2710(LF4)						
TLP2719	△	○	○	○	○	9, 11, 36, 39
TLP2719(LF4)						
TLP2735	○	○	○	○	○	11, 40
TLP2745	○	○	○	○	○	9, 11, 38, 40
TLP2745(LF4)						
TLP2748	○	○	○	○	○	9, 11, 38, 40
TLP2748(LF4)						
TLP2761	○	○	○	○	○	9, 37
TLP2761(LF4)						
TLP2766	○	○	○			9, 37
TLP2766F						
TLP2766A	○	○	○	○	○	9, 37
TLP2766A(LF4)						
TLP2767	○	○	○	○	○	9, 37
TLP2768	○	○	○			9, 37
TLP2768F						
TLP2768A	○	○	○	○	○	9, 37
TLP2768(LF4)						
TLP2770	○	○	○	○	○	9, 37
TLP29xx						
TLP2955	○	○	○	○	○	9, 11, 36, 39
TLP2955F						
TLP2958	○	○	○	○	○	9, 11, 37, 39
TLP2958F						
TLP2962	○	○	○	○	○	9, 37
TLP2962F						

Photocouplers	Safety Standards					Page
	UL1577	cUL	VDE1	VDE2	CQC	
TLP30xx						
TLP3052A	○	○	○	○	○	14, 42
TLP3052AF						
TLP3062A	○	○	○	○	○	14, 42
TLP3062AF						
TLP3064(S)	○	○	○	○		14, 42
TLP3064F(S)						
TLP3073	○	○	○	○	○	14, 42
TLP3073F						
TLP3083	○	○	○	○	○	14, 42
TLP3083F						
TLP39xx						
TLP3902	○	○				18, 45
TLP3904	○					18, 45
TLP3905	○	○	○	○		18, 45
TLP3906	○	○	○	○		18, 45
TLP3914	○					18, 45
TLP3924	○					18, 45
TLP5xxx						
TLP5214	○	○	○	○	○	7, 35
TLP5214A	○	○	○	○		7, 35
TLP5231	○	○	○	○	△	7, 35
TLP5701	○	○	○	○	○	13, 40
TLP5701(LF4)	○	○	○	○	○	13, 40
TLP5702	○	○	○	○	○	13, 41
TLP5702(LF4)	○	○	○	○	○	13, 41
TLP5711H	○	○	○	○	○	13, 41
TLP5751	○	○	○	○	○	13, 41
TLP5751(LF4)	○	○	○	○	○	13, 41
TLP5752	○	○	○	○	○	13, 41
TLP5752(LF4)	○	○	○	○	○	13, 41
TLP5754	○	○	○	○	○	13, 41
TLP5754(LF4)	○	○	○	○	○	13, 41
TLP5771	○	○	○	○	○	13, 41
TLP5771(LF4)	○	○	○	○	○	13, 41
TLP5772	○	○	○	○	○	13, 41
TLP5772(LF4)	○	○	○	○	○	13, 41
TLP5774	○	○	○	○	○	13, 41
TLP5774(LF4)	○	○	○	○	○	13, 41
TLP5832	○	○	○	○		13, 41
TLP7xxx						
TLP7820	○	○	○	○	○	5, 35
TLP7830	○	○	○	○	○	5, 35
TLP7920	○	○	○	○	○	5, 35
TLP7920F						
TLP7930	○	○	○	○	○	5, 35
TLP7930F						
Other						
TLPN137	○	○	○	○		9, 38

The ○ mark denotes "Certified," whereas the △ mark signifies "Pending" (as of March 2020).

Photorelays	Safety Standards						Page
	UL1577	UL508	cUL	VDE1	VDE2	CQC	
TLP1xx							
TLP170A	○		○	○			22, 47
TLP170D	○		○	○			22, 47
TLP170G	○		○	○			22, 47
TLP170J	○		○	○			22, 47
TLP171A	○		○	○			22, 47
TLP171D	○		○	○			22, 47
TLP171GA	○		○	○			22, 47
TLP171J	○		○	○			22, 47
TLP172AM	○	○	○	○			22, 47
TLP172GM	○	○	○	○			22, 47
TLP172GAM	○		○	○			22, 47
TLP174G	○		○				22, 47
TLP174GA	○						22, 47
TLP175A	○		○	○	○	○	22, 47
TLP176AM	○	○	○	○			22, 47
TLP176D	○		○	○			22, 47
TLP176G	○		○	○			22, 47
TLP176GA	○			○			22, 47
TLP179D	○		○				22, 47
TLP192A	○		○				22, 47
TLP192G	○		○				22, 47
TLP197G	○		○	○			22, 47
TLP197GA	○						22, 47
TLP199D	○		○				22, 47
TLP2xx							
TLP200D	○						24, 49
TLP202A	○						24, 49
TLP202G	○			○			24, 49
TLP206A	○						24, 49
TLP206G	○			○			24, 49
TLP206GA	○			○			24, 49
TLP222A	○		○				23, 48
TLP222A-2	○		○				24, 49
TLP222D	○		○				23, 48
TLP222G	○		○				23, 48
TLP222G-2	○		○				24, 49
TLP224G	○		○				23, 48
TLP224G-2	○		○				24, 49
TLP224GA	○		○				23, 48
TLP224GA-2	○		○				24, 49
TLP228G	○		○				23, 48
TLP228G-2	○		○				24, 49
TLP240A	○	○	○	○		○	23, 48
TLP240AF							
TLP240D	○	○	○	○		○	23, 48
TLP240DF							
TLP240G	○	○	○	○		○	23, 48
TLP240GF							
TLP240GA	○	○	○	○	○	○	23, 48
TLP240GAF							
TLP240J	○	○	○	○	○	○	23, 48
TLP240JF							
TLP241A	○		○	○			23, 48
TLP241AF							

Photorelays	Safety Standards						Page
	UL1577	UL508	cUL	VDE1	VDE2	CQC	
TLP5xx							
TLP592A	○						23, 48
TLP592G	○						23, 48
TLP597A	○						23, 48
TLP597G	○			○			23, 48
TLP597GA	○						23, 48
TLP598AA	○						23, 48
TLP598GA	○						23, 48
TLP7xxx							
TLP797GA	○		○	○			23, 48
TLP797GAF							
TLP797J	○		○	○			23, 48
TLP797JF							
TLP798GA	○		○				23, 48
TLP31xx							
TLP3100	○		○				22, 47
TLP3102	○		○				22, 47
TLP3103	○		○				22, 47
TLP3105	○		○				22, 47
TLP3106	○		○				22, 47
TLP3106A	○			○			22, 47
TLP3107	○		○				22, 47
TLP3107A	○			○			22, 47
TLP3109	○		○				22, 47
TLP3109A	○			○			22, 47
TLP3122	○		○	○			22, 47
TLP3122A	○	○	○	○			22, 47
TLP3123	○		○	○			22, 47
TLP3125	○		○				22, 47
TLP3127	○		○				22, 47
TLP3145	○		○				22, 47
TLP3146	○						22, 47
TLP3147	○						22, 47
TLP3149	○						22, 47
TLP32xx							
TLP3203	○						22, 46
TLP3212	○						22, 46
TLP3214	○						22, 46
TLP3215	○						22, 46
TLP3216	○						22, 46
TLP3217	○						22, 46
TLP3220	○						22, 46
TLP3230	○						22, 46
TLP3231	○						22, 46
TLP3240	○						22, 46
TLP3241	○						22, 46
TLP3250	○						22, 46
TLP3275	○						22, 46
TLP33xx							
TLP3303	○						22, 46
TLP3306	○						22, 46
TLP3312	○						22, 46
TLP3315	○						22, 46
TLP3317	○						22, 46
TLP3319	○						22, 46
TLP3320	○						22, 46
TLP3330	○						22, 46
TLP3340	○						22, 46
TLP3341	○						22, 46

The O mark denotes "Certified," whereas the Δ mark signifies "Pending" (as of March 2020).

Photorelays	Safety Standards						Page
	UL1577	UL508	cUL	VDE1	VDE2	CQC	
TLP3342	○						22, 46
TLP3350	○						22, 46
TLP3351	○						22, 46
TLP3375	○						22, 46
TLP34xx							
TLP3403							22, 46
TLP3403R							22, 47
TLP3406S							22, 46
TLP3406SRH							22, 47
TLP3406SRL							22, 47
TLP3407S							22, 46
TLP3407SR							22, 47
TLP3407SRH							22, 47
TLP3407SRL							22, 47
TLP3409S							22, 46
TLP3412							22, 46
TLP3412R							22, 47
TLP3412SRH							22, 47
TLP3414							22, 46
TLP3417							22, 46
TLP3419							22, 46
TLP3420							22, 46
TLP3431							22, 46
TLP3440							22, 46
TLP3440S							22, 46
TLP3441							22, 46
TLP3442							22, 46
TLP3450							22, 46
TLP3451							22, 46
TLP3475							22, 46
TLP3475R							22, 47
TLP3475S							22, 46
TLP3480							22, 46
TLP3481							22, 46
TLP3482							22, 46
TLP3483							22, 46
TLP3484							22, 46
TLP35xx							
TLP3542	○		○				23, 48
TLP3543	○		○				23, 48
TLP3543A	○	○	○	○			23, 48
TLP3544	○		○				23, 48
TLP3545	○		○				23, 48
TLP3545A	○	○	○	○			23, 48
TLP3546	○		○				23, 48
TLP3546A	○	○	○	○			23, 48
TLP3547	○	○	○	○			23, 48
TLP3548	○	○	○	○			23, 48
TLP3549	○	○	○	○			23, 48
TLP3553	○		○				23, 48
TLP3553A	○	○	○	○			23, 48
TLP3554	○		○				23, 48
TLP3555	○		○				23, 48
TLP3555A	○	○	○	○			23, 48
TLP3556	○		○				23, 48
TLP3556A	○	○	○	○			23, 48
TLP3558A	○	○	○	○			23, 48
TLP38xx							
TLP3823	○		○				23, 48
TLP3825	○		○				23, 48

Photorelays	Safety Standards						Page
	UL1577	UL508	cUL	VDE1	VDE2	CQC	
TLP4xxx							
TLP4006G							24, 49
TLP4026G	○						24, 49
TLP4176A	○						24, 49
TLP4176G	○						24, 49
TLP4197G	○						24, 49
TLP4206G	○						24, 49
TLP4227G	○						24, 49
TLP4227G-2	○						24, 49
TLP4597G	○						24, 49

Package Lineup

Toshiba's photocouplers are available in various types of packages, ranging from conventional DIP packages to ultra-small surface-mount packages.

Through Hole

		Isolation Amplifier	Smart IGBT Gate Driver Photocouplers	High-Speed Logic Photocouplers	IPM Driver Photocouplers	IGBT/MOSFET Driver Photocouplers	Triac-Output Photocouplers	Thyristor-Output Photocouplers	Transistor-Output Photocouplers	Photovoltaic-Output Photocouplers	Photorelays
 <p>DIP4 DIP8</p> <p>DIP6</p> <p>※Toshiba offers also a lead-forming solution for the surface mounting of photocouplers in DIP packages depends on request.</p>	DIP4						✓		✓		✓
	DIP6						✓	✓	✓	✓	✓
	DIP8	✓		✓	✓	✓		✓			✓
	 <p>SDIP6</p>			✓	✓	✓					
 <p>SO4 SO6 SO8 SO16</p> <p>※Reinforced insulation</p>	SO4								✓		
	SO6			✓	✓	✓	✓		✓	✓	✓
	SO8			✓	✓	✓					
	SO16								✓		
	SO16L										
 <p>SO6L SO8L SO16L</p> <p>※Reinforced insulation</p>	SO6L			✓	✓	✓			✓		
	SO8L	✓		✓		✓					
	SO16L		✓								
	 <p>MFSOP6</p>			✓				✓		✓	
 <p>2.54SOP4 2.54SOP6 2.54SOP8</p>	2.54SOP4										✓
	2.54SOP6										✓
	2.54SOP8										✓
 <p>SSOP4 USOP4</p>	SSOP4									✓	✓
	USOP4										✓
 <p>VSON4 S-VSON4 S-VSON4T</p> <p>※Ultra-small leadless packages</p>	VSON4										✓
	S-VSON4										✓
	S-VSON4T										✓

Package Dimensions and Land Pattern Examples

Unit: mm

4 pin DIP type

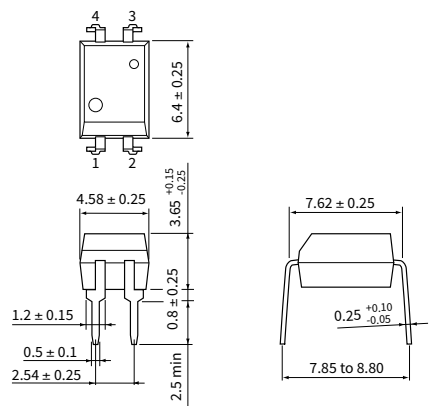
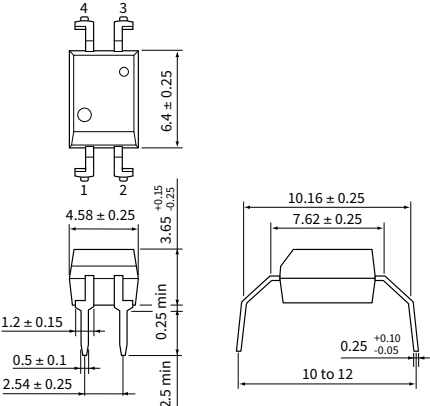
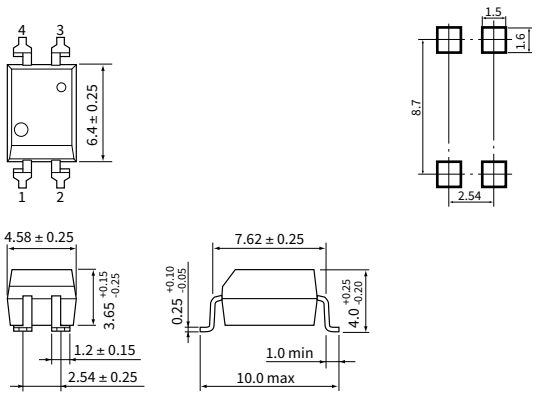
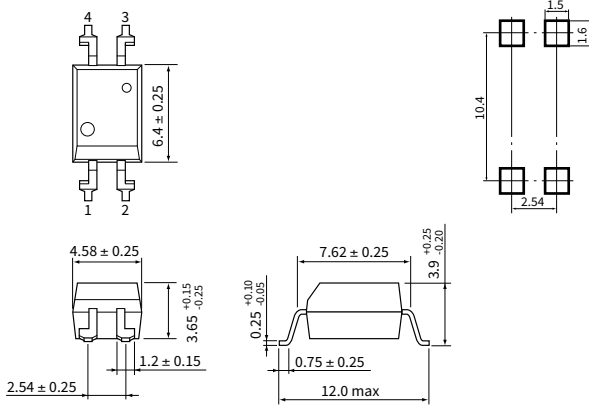
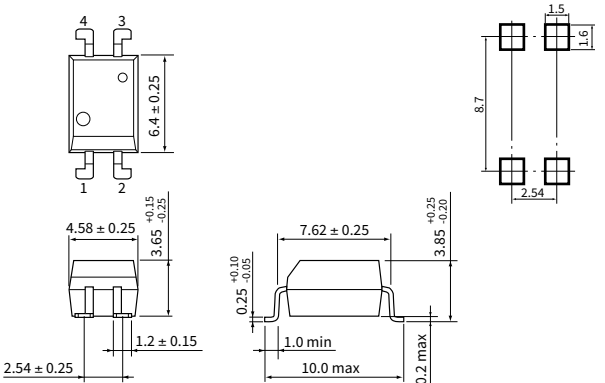
DIP4 (standard)	DIP4 (F type) DIP4 (LF2)
 <p>Top view: 6.4 ± 0.25 (width), 4.58 ± 0.25 (pin pitch), 7.62 ± 0.25 (body width), 1.2 ± 0.15 (pin width), 0.5 ± 0.1 (pin thickness), 2.54 ± 0.25 (pin spacing), 2.5 min (pin length), 0.8 ± 0.25 (lead thickness), 3.65^{+0.15}_{-0.25} (lead length), 0.25^{+0.10}_{-0.05} (lead thickness), 7.85 to 8.80 (total length)</p> <p>Side view: 6.4 ± 0.25 (height), 4.58 ± 0.25 (pin pitch), 7.62 ± 0.25 (body width), 1.2 ± 0.15 (pin width), 0.5 ± 0.1 (pin thickness), 2.54 ± 0.25 (pin spacing), 2.5 min (pin length), 0.8 ± 0.25 (lead thickness), 3.65^{+0.15}_{-0.25} (lead length), 0.25^{+0.10}_{-0.05} (lead thickness), 7.85 to 8.80 (total length)</p>	 <p>Top view: 6.4 ± 0.25 (width), 10.16 ± 0.25 (body width), 7.62 ± 0.25 (pin pitch), 1.2 ± 0.15 (pin width), 0.5 ± 0.1 (pin thickness), 2.54 ± 0.25 (pin spacing), 2.5 min (pin length), 0.25 min (lead length), 0.25^{+0.10}_{-0.05} (lead thickness), 10 to 12 (total length)</p> <p>Side view: 6.4 ± 0.25 (height), 4.58 ± 0.25 (pin pitch), 10.16 ± 0.25 (body width), 1.2 ± 0.15 (pin width), 0.5 ± 0.1 (pin thickness), 2.54 ± 0.25 (pin spacing), 2.5 min (pin length), 0.25 min (lead length), 0.25^{+0.10}_{-0.05} (lead thickness), 10 to 12 (total length)</p>
DIP4 (LF1)	DIP4 (LF4)
 <p>Top view: 6.4 ± 0.25 (width), 1.5 (pin width), 1.6 (pin thickness), 8.7 (total length), 2.54 (pin spacing)</p> <p>Side view: 6.4 ± 0.25 (height), 4.58 ± 0.25 (pin pitch), 7.62 ± 0.25 (body width), 1.2 ± 0.15 (pin width), 0.5 ± 0.1 (pin thickness), 2.54 ± 0.25 (pin spacing), 2.5 min (pin length), 0.25^{+0.10}_{-0.05} (lead length), 1.0 min (lead length), 4.0^{+0.25}_{-0.20} (lead length), 10.0 max (total length)</p>	 <p>Top view: 6.4 ± 0.25 (width), 1.5 (pin width), 1.6 (pin thickness), 10.4 (total length), 2.54 (pin spacing)</p> <p>Side view: 6.4 ± 0.25 (height), 4.58 ± 0.25 (pin pitch), 7.62 ± 0.25 (body width), 1.2 ± 0.15 (pin width), 0.5 ± 0.1 (pin thickness), 2.54 ± 0.25 (pin spacing), 2.5 min (pin length), 0.25^{+0.10}_{-0.05} (lead length), 0.75 ± 0.25 (lead length), 12.0 max (total length)</p>
DIP4 (LF5)	
 <p>Top view: 6.4 ± 0.25 (width), 1.5 (pin width), 1.6 (pin thickness), 8.7 (total length), 2.54 (pin spacing)</p> <p>Side view: 6.4 ± 0.25 (height), 4.58 ± 0.25 (pin pitch), 7.62 ± 0.25 (body width), 1.2 ± 0.15 (pin width), 0.5 ± 0.1 (pin thickness), 2.54 ± 0.25 (pin spacing), 2.5 min (pin length), 0.25^{+0.10}_{-0.05} (lead length), 1.0 min (lead length), 3.85^{+0.25}_{-0.20} (lead length), 10.0 max (total length), 0.2 max (lead length)</p>	

※ All dimensions without a tolerance are reference dimensions.

※ The PCB Land Pattern dimensions shown above are for reference only and should be confirmed by implementation.

▶ 6 pin DIP type

DIP6 (standard)

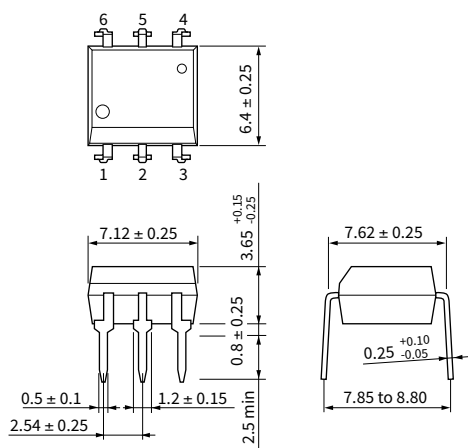

DIP6 (F type)
DIP6 (LF2)

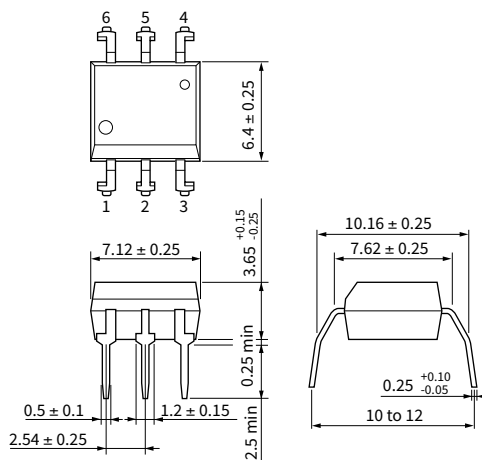

DIP6 (LF1)

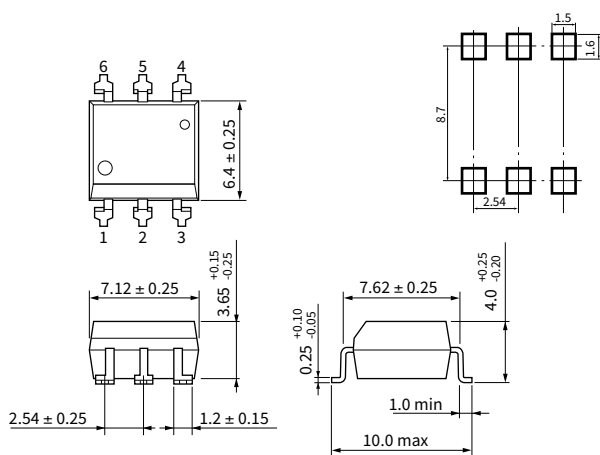

DIP6 (LF4)

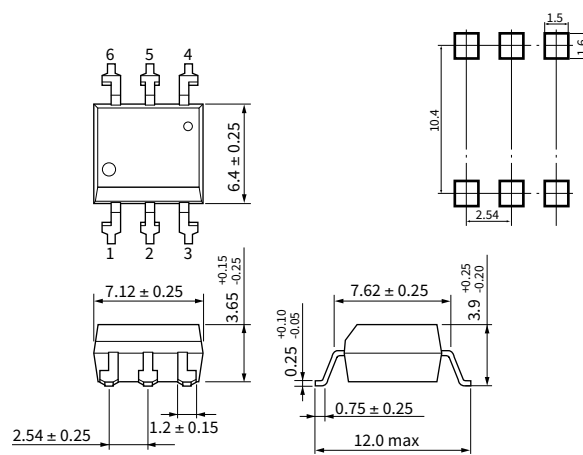

DIP6 (LF5)

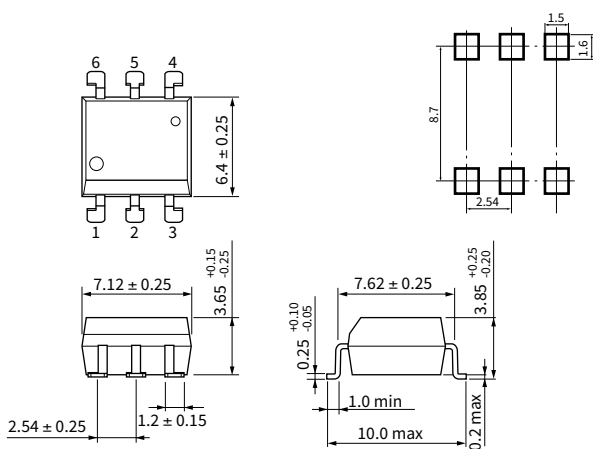

- ※ All dimensions without a tolerance are reference dimensions.
- ※ The PCB land Pattern dimensions shown above are for reference only and should be confirmed it by implementation.

▶ 8 pin DIP type

DIP8 (standard)

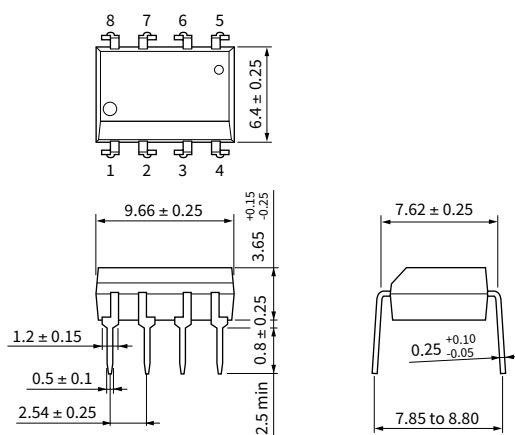

DIP8 (F type)
DIP8 (LF2)

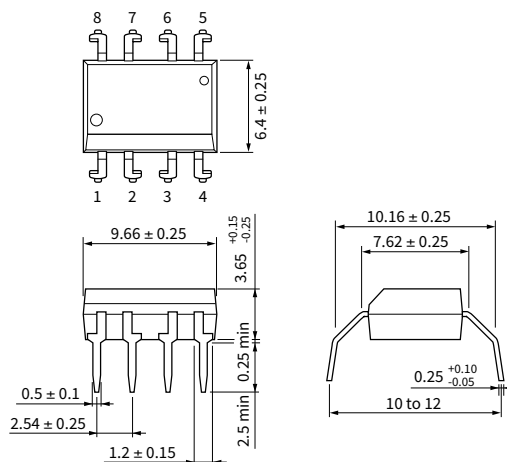

DIP8 (LF1)

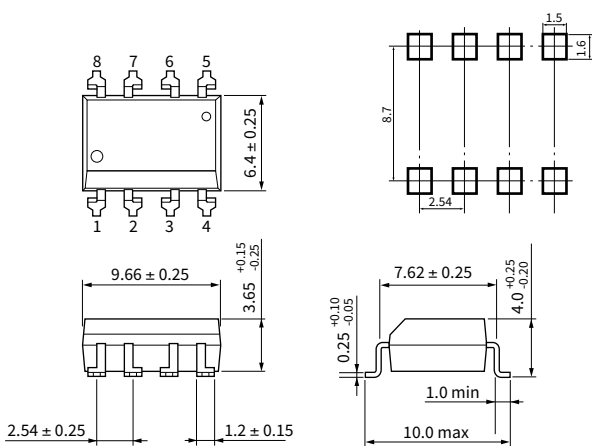

DIP8 (LF4)

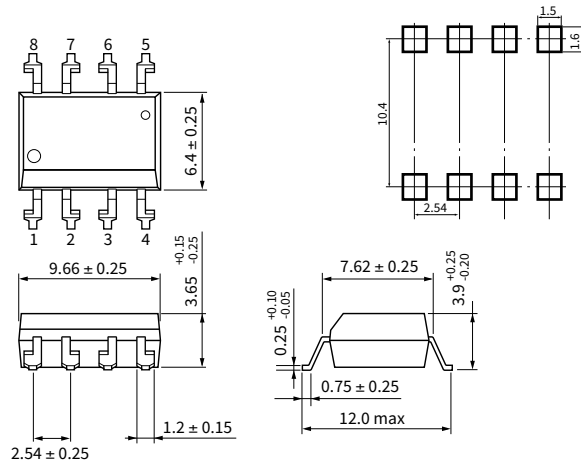

DIP8 (LF5)

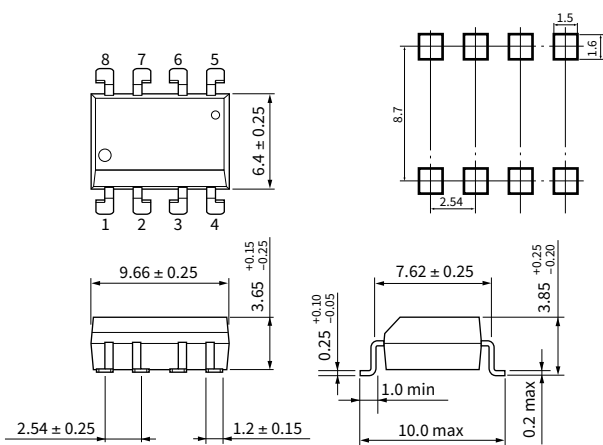

※ All dimensions without a tolerance are reference dimensions.
 ※ The PCB land Pattern dimensions shown above are for reference only and should be confirmed it by implementation.

▶ SDIP type / Other DIP type

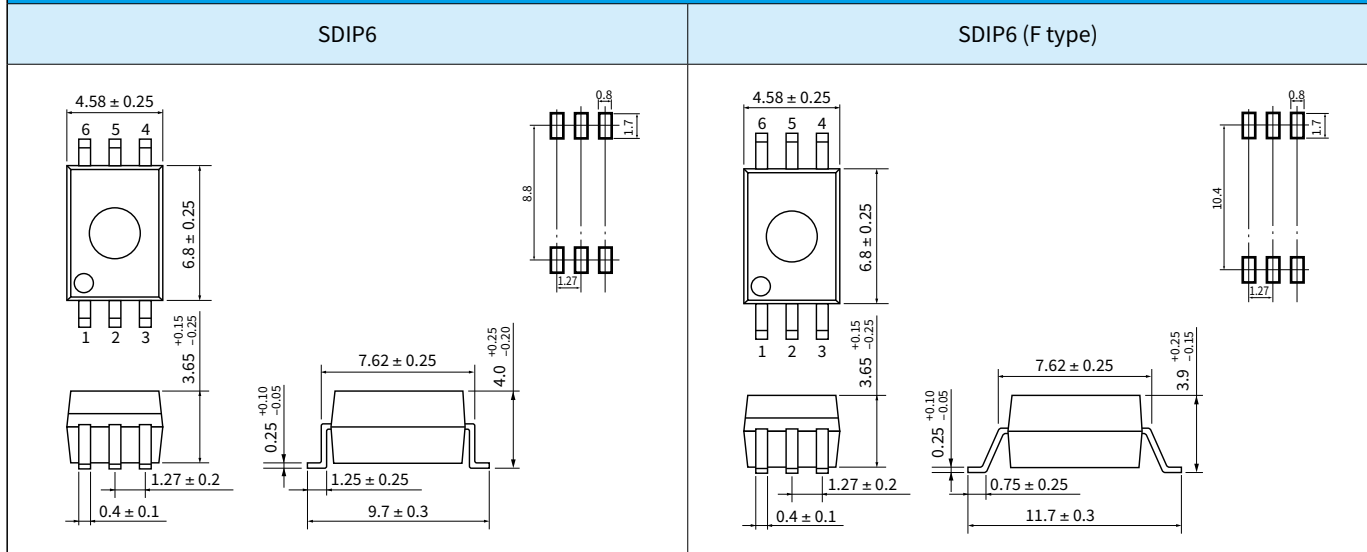

5 pin DIP6	5 pin DIP6 (cut)
------------	------------------

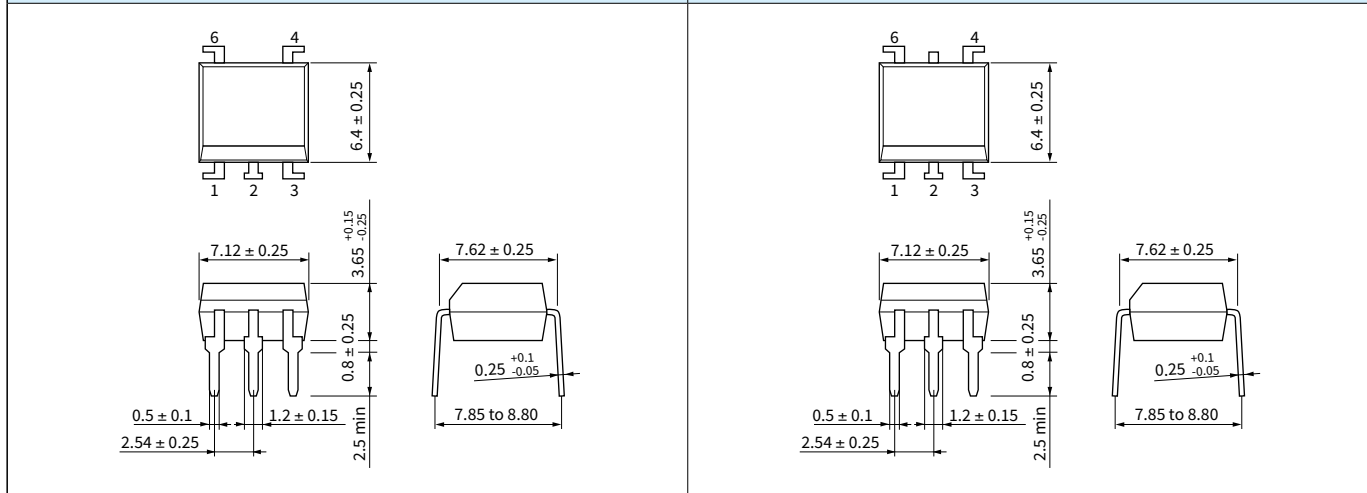

7 pin DIP8

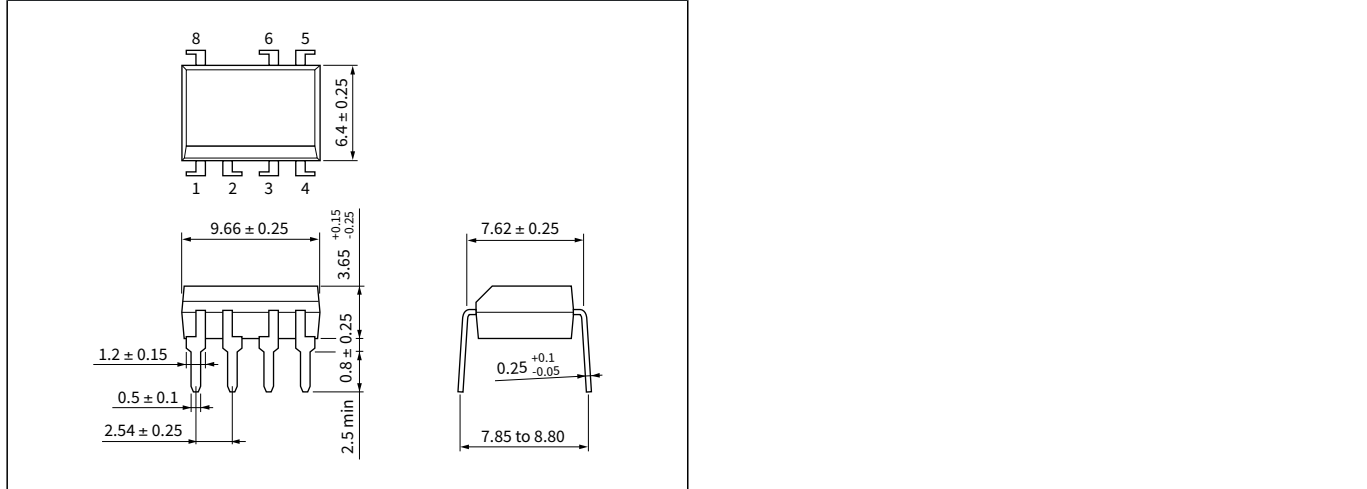

※ All dimensions without a tolerance are reference dimensions.
 ※ The PCB land Pattern dimensions shown above are for reference only and should be confirmed it by implementation.

► SO type

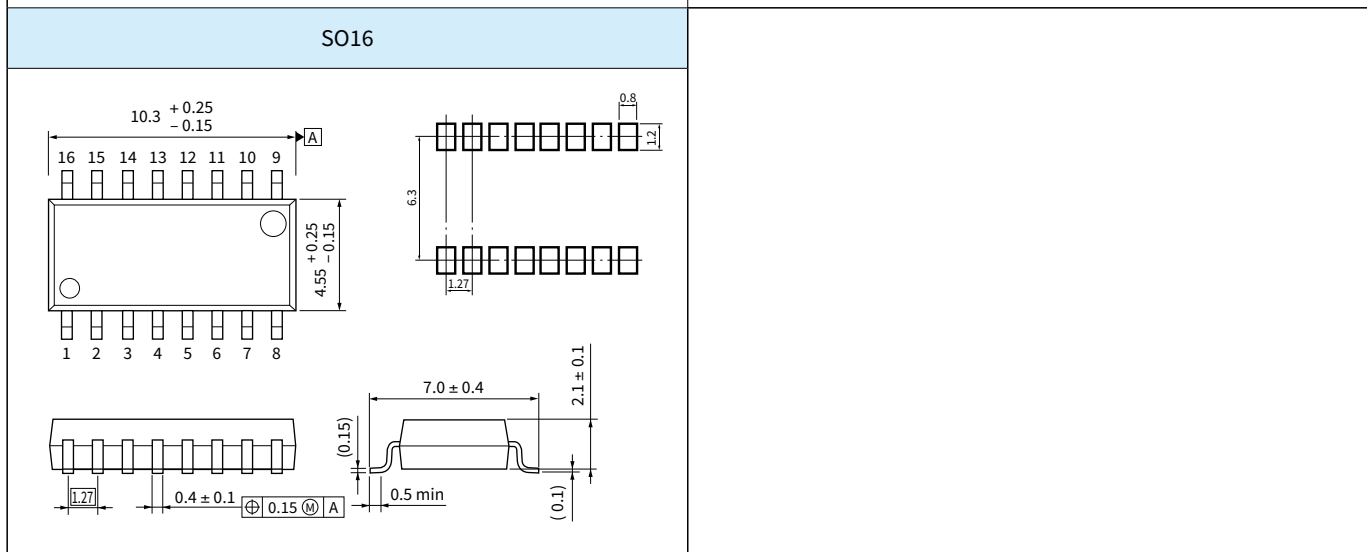
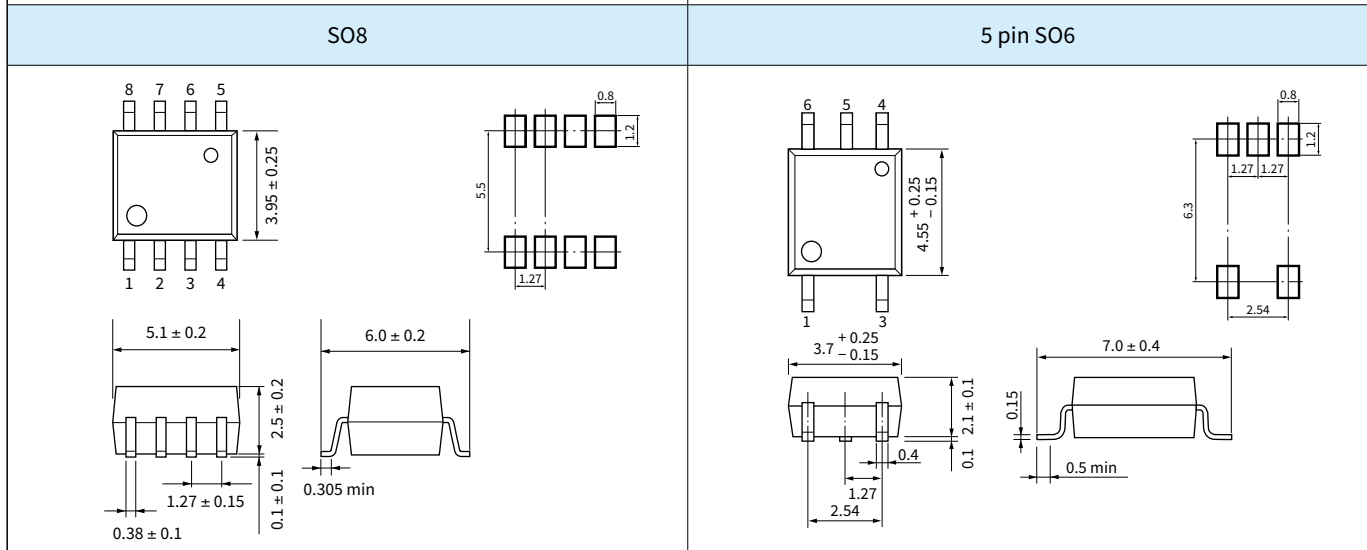
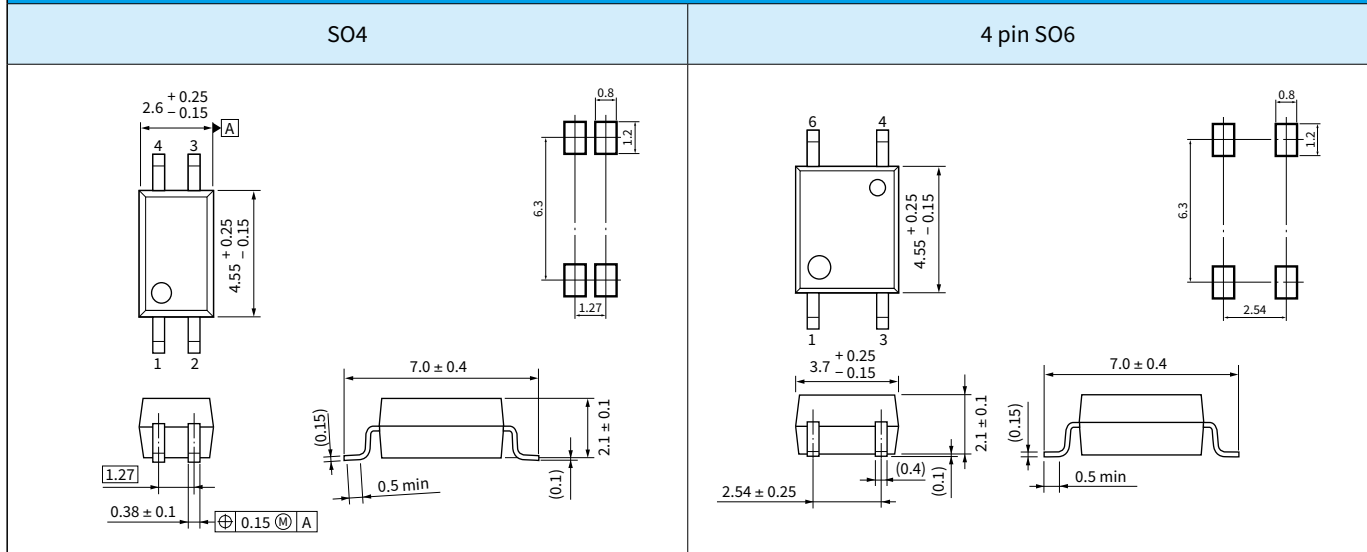

※ All dimensions without a tolerance are reference dimensions.
 ※ The PCB land Pattern dimensions shown above are for reference only and should be confirmed it by implementation.

► SOL type

SO6L

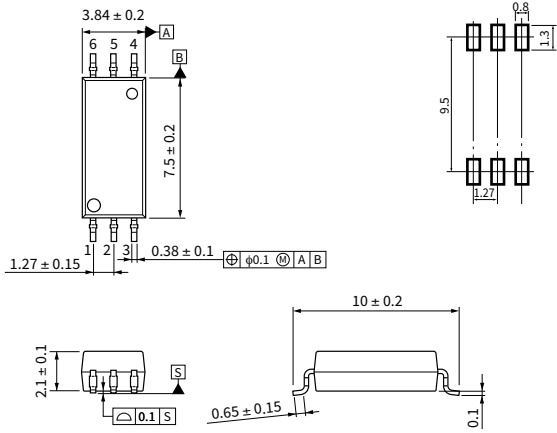

SO6L (LF4)

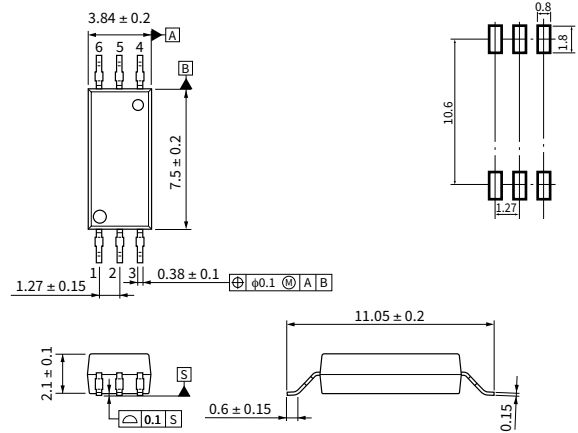

SO8L

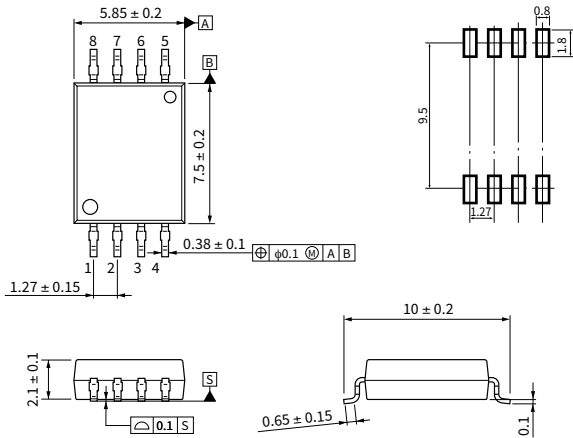

SO8L (LF4)

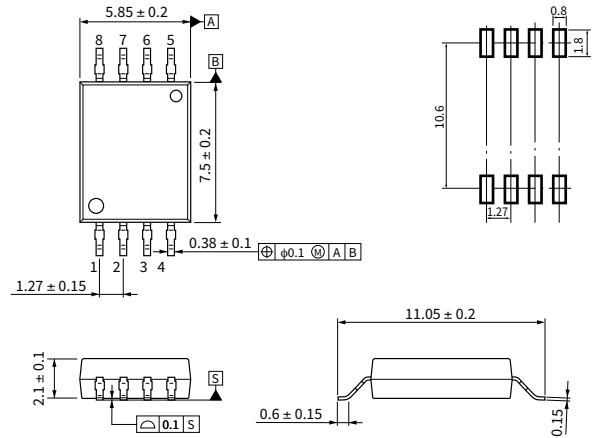

SO16L

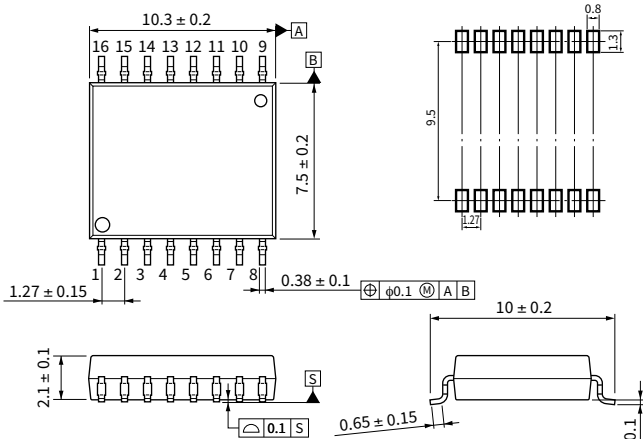

4 pin SO6L

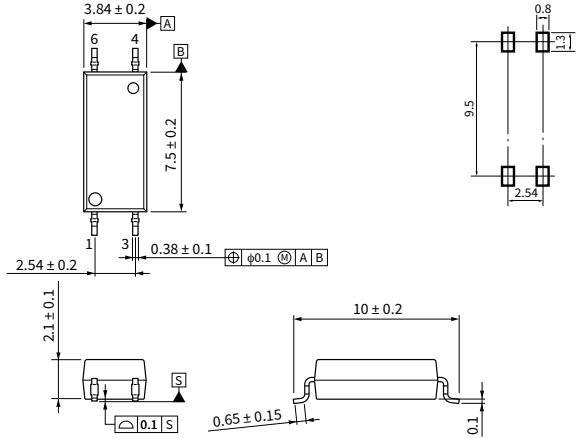

※ All dimensions without a tolerance are reference dimensions.
 ※ The PCB land Pattern dimensions shown above are for reference only and should be confirmed it by implementation.

▶ MFSOP type	▶ 2.54SOP type
<p style="text-align: center;">4 pin MFSOP6</p> <p>Top view: Pin 1 at bottom-left, Pin 3 at bottom-right, Pin 6 at top-left, Pin 4 at top-right. Dimensions: width 4.4, pin pitch 2.54, pin width 0.8, pin height 1.2, body width 3.6 ± 0.2, body height 2.5 ± 0.2, lead length 0.4, lead thickness 0.1.</p> <p>Side view: Body length 7.0 ± 0.4, lead height 0.15, lead length 0.5 min.</p> <p>Cross-section: Pin pitch 2.54, pin width 0.8, pin height 1.2.</p>	<p style="text-align: center;">2.54SOP4</p> <p>Top view: Pin 1 at bottom-left, Pin 2 at bottom-right, Pin 4 at top-left, Pin 3 at top-right. Dimensions: width 4.4 ± 0.25, pin pitch 2.54, pin width 0.8, pin height 1.2, body width 3.9 ± 0.25, body height 2.1 max, lead length 0.4 ± 0.1, lead thickness 0.1 ± 0.1.</p> <p>Side view: Body length 7.0 ± 0.4, lead height 0.15, lead length 0.6 ± 0.3.</p> <p>Cross-section: Pin pitch 2.54 ± 0.25, pin width 0.8, pin height 1.2.</p>
<p style="text-align: center;">4 pin MFSOP6 (cut)</p> <p>Top view: Pin 1 at bottom-left, Pin 3 at bottom-right, Pin 6 at top-left, Pin 4 at top-right. Dimensions: width 4.4, pin pitch 2.54, pin width 0.8, pin height 1.2, body width 3.6 ± 0.2, body height 2.5 ± 0.2, lead length 0.4, lead thickness 0.1.</p> <p>Side view: Body length 7.0 ± 0.4, lead height 0.15, lead length 0.5 min.</p> <p>Cross-section: Pin pitch 2.54, pin width 0.8, pin height 1.2.</p>	<p style="text-align: center;">2.54SOP6</p> <p>Top view: Pin 1 at bottom-left, Pin 2 at bottom-middle, Pin 3 at bottom-right, Pin 6 at top-left, Pin 5 at top-middle, Pin 4 at top-right. Dimensions: width 4.4 ± 0.25, pin pitch 2.54, pin width 0.8, pin height 1.2, body width 6.3 ± 0.25, body height 2.1 max, lead length 0.4 ± 0.1, lead thickness 0.1 ± 0.1.</p> <p>Side view: Body length 7.0 ± 0.4, lead height 0.15, lead length 0.6 ± 0.3.</p> <p>Cross-section: Pin pitch 2.54 ± 0.25, pin width 0.8, pin height 1.2.</p>
<p style="text-align: center;">5 pin MFSOP6</p> <p>Top view: Pin 1 at bottom-left, Pin 3 at bottom-right, Pin 6 at top-left, Pin 5 at top-middle, Pin 4 at top-right. Dimensions: width 4.4, pin pitch 2.54, pin width 0.8, pin height 1.2, body width 3.6 ± 0.2, body height 2.5 ± 0.2, lead length 0.4, lead thickness 0.1, distance between pins 1 and 3 is 1.27.</p> <p>Side view: Body length 7.0 ± 0.4, lead height 0.15, lead length 0.5 min.</p> <p>Cross-section: Pin pitch 2.54, pin width 0.8, pin height 1.2.</p>	<p style="text-align: center;">2.54SOP8</p> <p>Top view: Pin 1 at bottom-left, Pin 2 at bottom-middle, Pin 3 at bottom-right, Pin 4 at bottom-far-right, Pin 8 at top-left, Pin 7 at top-middle, Pin 6 at top-right, Pin 5 at top-far-right. Dimensions: width 4.4 ± 0.25, pin pitch 2.54, pin width 0.8, pin height 1.2, body width 9.4 ± 0.25, body height 2.1 max, lead length 0.4 ± 0.1, lead thickness 0.1 ± 0.1.</p> <p>Side view: Body length 7.0 ± 0.4, lead height 0.15, lead length 0.6 ± 0.3.</p> <p>Cross-section: Pin pitch 2.54 ± 0.25, pin width 0.8, pin height 1.2.</p>

※ All dimensions without a tolerance are reference dimensions.

※ The PCB land Pattern dimensions shown above are for reference only and should be confirmed it by implementation.

▶ VSON/USOP/SSOP type

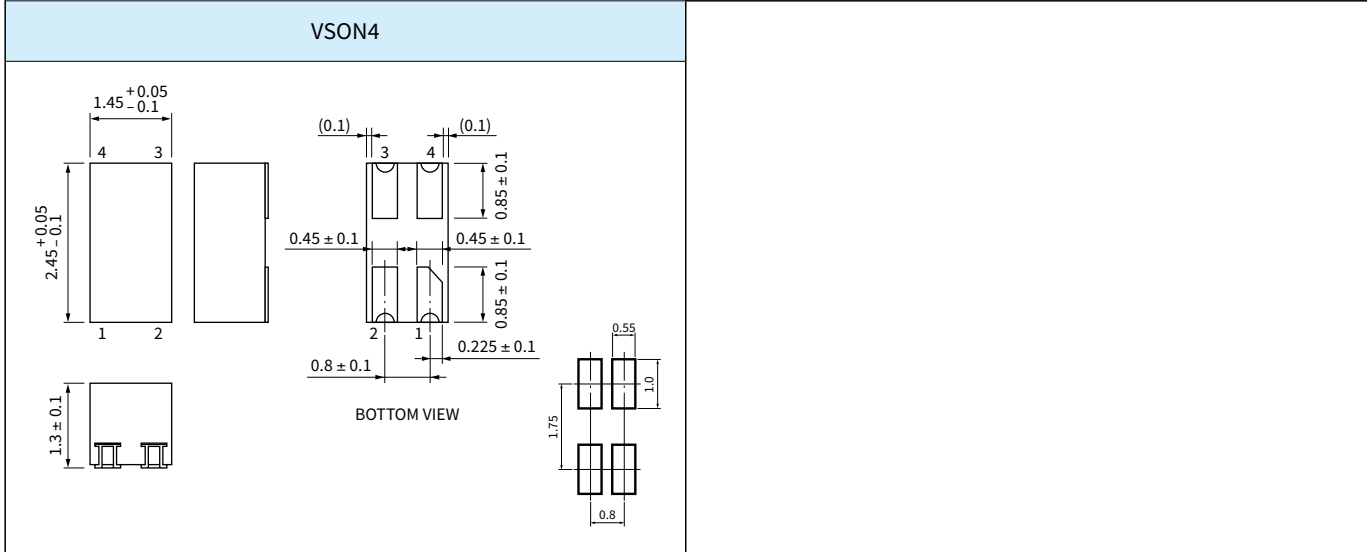
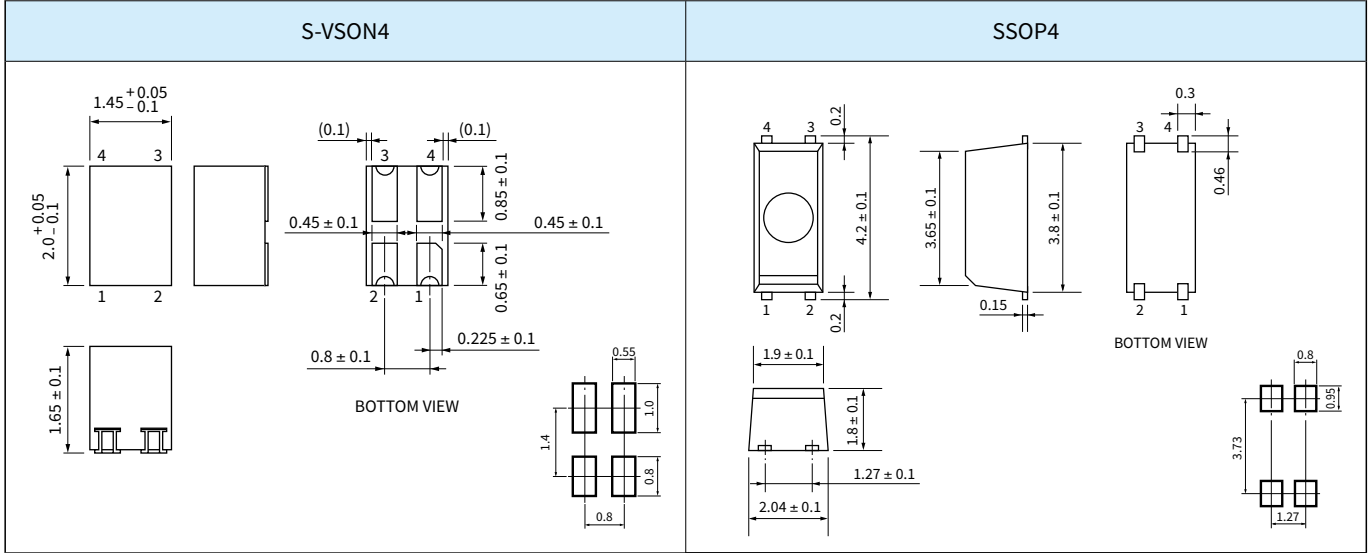
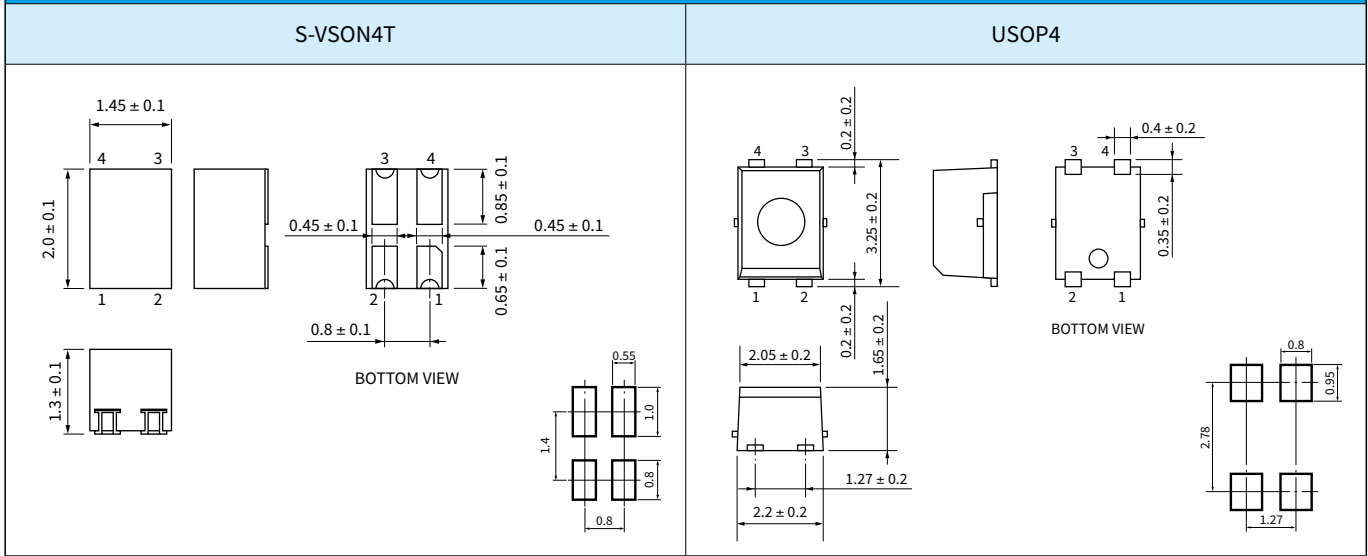

※ All dimensions without a tolerance are reference dimensions.
 ※ The PCB land Pattern dimensions shown above are for reference only and should be confirmed it by implementation.

Rank Marking

Transistor-output photocouplers are ranked according to their Current Transfer Ratio (CTR) ranges, whereas thyristor-output and triac-output photocouplers are ranked according to their maximum I_{FT} value. The following gives the rank classifications and rank marks printed on packages. Nevertheless, note that the rank classifications differ from product to product. For details, please refer to the relevant technical datasheets.

Current Transfer Ratios (CTRs) of Transistor-Output Photocouplers

Applied CTR Rank Selections are as bellows.

(○ Available, △ Contact your Toshiba sales representative)

Input Type	Rank Name	None		Y	YH	GR	GRL	GRH	GB		BL	BLL	LA(*)	LGB(*)
	CTR Rank Marking	Blank		YE	Y+	GR	G	G+	GB		BL	B	LA	LB
	CTR	max	min	50	75	100	100	150	100	100	200	200	50	100
				50	150	300	200	300	400	600	600	400	600	600
DC Input	TLP183		○	○	○	○	○	○		○	○	○		
	TLP185(SE)		○	○	○	○	○	○		○	○	○		
	TLP188		○							○				
	TLP291-4	○							○					
	TLP291(SE)		○	○	○	○	○	○		○	○	○		
	TLP293		○	○	○	○	○	○		○	○	○		
	TLP293-4		○							○			○	○
	TLP383		○	○	○	○	○	○		○	○	○		
	TLP385		○	○	○	○	○	○		○	○	○		
	TLP388		○							○				
	TLP628M/628MF		○							○				
TLP785/785F		○	○	○	○	○	○		○	○	○			
AC Input	TLP182		○	○		○				○	○			
	TLP184(SE)		○	○		○				○	○			
	TLP290-4	○							○					
	TLP290(SE)		○	○		○				○	○			
	TLP292		○	○		○				○	○			
	TLP292-4		○							○			○	○
	TLP620M/620MF		○	○		○				○	○			

(*): The LA and LB rank are made CTR rank of the low input current condition.

Marking Examples

TLP183 (4 pin SO6 Package)

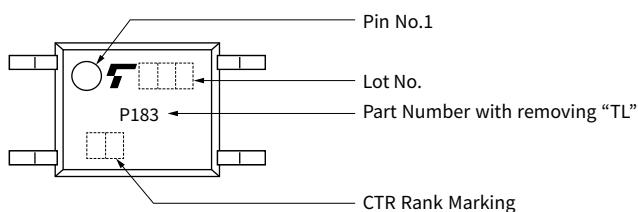

TLP785 (DIP4 Package)

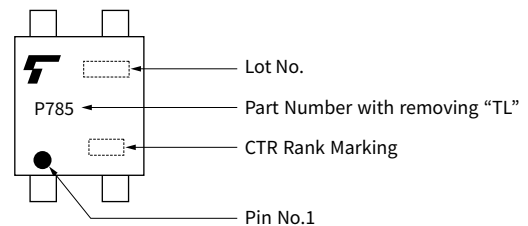

Trigger LED Current (I_{FT}) of Triac- and Thyristor-Output Photocouplers

	Off-state Output Terminal Voltage V_{DRM}	Part Number	Trigger LED Current I_{FT} (mA) max			
		Rank Name	None	IFT7	IFT5	IFT2
		I_{FT} Rank Marking	Blank	T7	T5	T2
Triac-output	600 V	TLP265J	10	7	—	—
		TLP266J	10	7	—	—
		TLP267J	3	—	—	2
		TLP268J	3	—	—	2
		TLP360J/TLP360JF	10	7	—	—
		TLP361J/TLP361JF	10	7	—	—
	800 V	TLP669L(S)/TLP669LF(S)	10	—	5	—
Thyristor-output	400 V	TLP148G	10	7	—	—

Only devices with an I_{FT} rank are listed herein.

Marking Examples

TLP265J (4 pin SO6 Package)

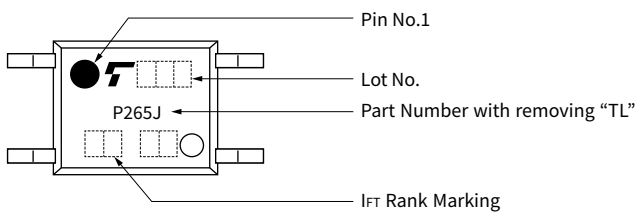

Note: 1. Specify both the part number and a rank in this format when ordering.

Examples: TLP183 (GB), TLP265J (T7)

2. For applying to safety standard certification, please specify the part number only.

Examples: $\frac{\text{Part number}}{\text{TLP183 (GB)}} \rightarrow \frac{\text{Use this part number}}{\text{TLP183}}$

Magazine Packing Specification

Unit: mm

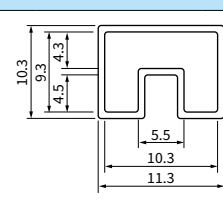
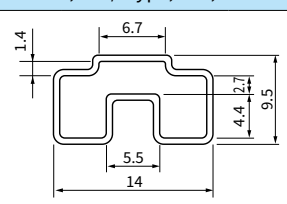
DIP type		Standard			Lead Forming LF1, LF2/Ftype, LF4, LF5		
Magazine	Dimensions						
	Pin Count	4 pin	6 pin	8 pin	4 pin	6 pin	8 pin
	Quantities per Magazine	100 pcs	50 pcs	50 pcs	100 pcs	50 pcs	50 pcs
Carton	Number of Magazines	4	20	60	4	40	
	Carton Dimensions	A	50 mm	67 mm	123 mm	60 mm	135 mm
		B	12 mm	51 mm	76 mm	13 mm	58 mm
		C	531 mm	559 mm	568 mm	531 mm	568 mm
Label Position	Y	Y	X	Y	X		

※ The magazine dimensions and packing specifications of the TLP785 differ. For details, contact your Toshiba sales representative.

Unit: mm

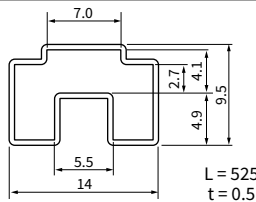
SDIP type		SDIP6		
Magazine	Dimensions			
	Quantities per Magazine	100 pcs		
Carton	Number of Magazines	40		
	Carton Dimensions	A	135 mm	
		B	58 mm	
		C	568 mm	
Label Position	X			

Unit: mm

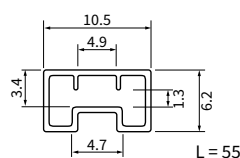
MFSOP type		MFSOP6			
Magazine	Dimensions				
	Quantities per Magazine	150 pcs			
Carton	Number of Magazines	4	24	40	
	Carton Dimensions	A	29 mm	77 mm	67 mm
		B	13 mm	31 mm	55 mm
		C	563 mm	586 mm	586 mm
Label Position	Y	Y	X		

Unit: mm

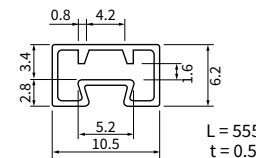
2.54SOP type		2.54SOP			
Magazine	Dimensions				
	Pin Count	4 pin (2.54SOP4)	6 pin (2.54SOP6)	8 pin (2.54SOP8)	
	Quantities per Magazine	100 pcs	75 pcs	50 pcs	
Carton	Number of Magazines	4	24	40	
	Carton Dimensions	A	29 mm	77 mm	67 mm
		B	13 mm	31 mm	55 mm
		C	563 mm	586 mm	586 mm
Label Position	Y	Y	X		

Unit : mm

SO type		SO4	SO6	SO8	SO16	
Magazine	Dimensions					
	Quantities per Magazine	175 pcs	125 pcs	100 pcs	50 pcs	
Carton	Number of Magazines	40	40	24	40	
	Carton Dimensions	A	71 mm	70 mm	75 mm	61 mm
		B	32 mm	55 mm	29 mm	56 mm
		C	584 mm	585 mm	579 mm	586 mm
Label Position	X	X	X	X		

Unit: mm

SOL type		SOL/SOL (LF4)		
Magazine	Dimensions			
	Pin Count	6 pin (SO6L)	8 pin (SO8L)	16 pin (SO16L)
	Quantities per Magazine	125 pcs	75 pcs	50 pcs
Carton	Number of Magazines	20		
	Carton Dimensions	A	70 mm	
		B	30 mm	
		C	585 mm	
Label Position	Y			

※ All dimensions are typical values.

Packing

Photocouplers are stored in magazines, and packed into cartons. An overview of the procedure of packing the device is shown below.

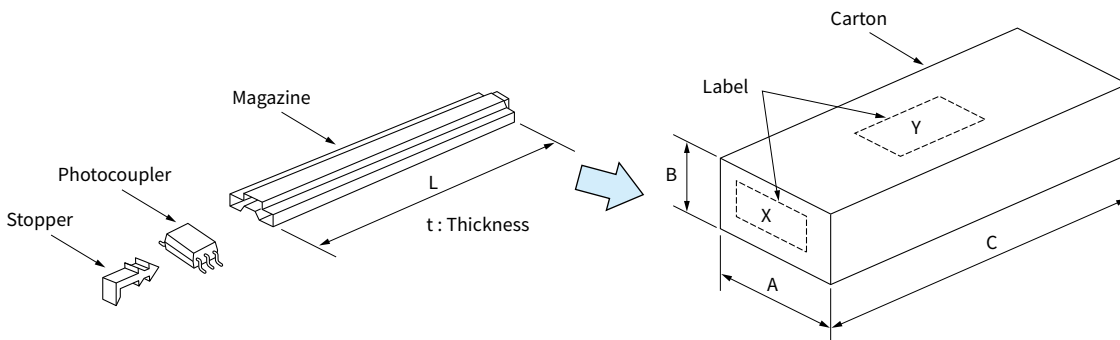

Tape-and-Reel Specification

Tape and Reel Dimensions

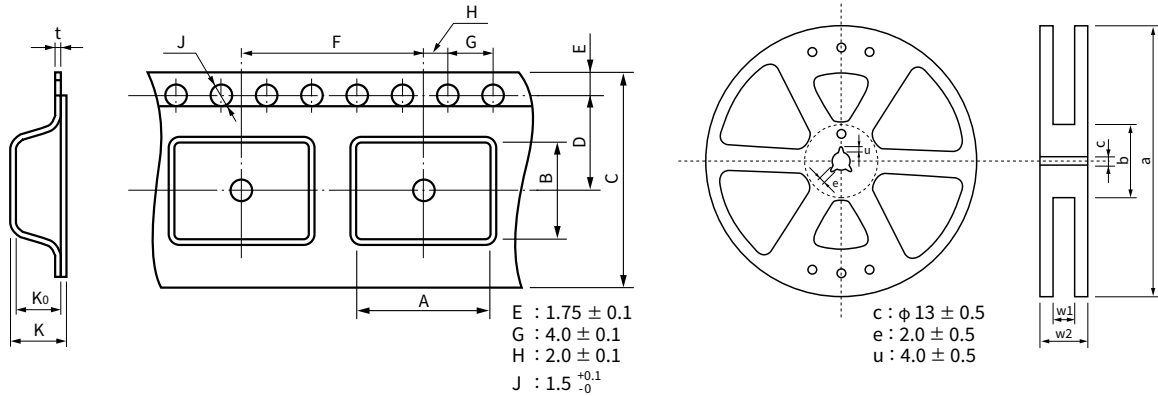

Unit: mm

Package	DIP (LF1) (LF5)	DIP (LF4)	SDIP6	SDIP6 F type	4 pin/5 pin MFSOP6	2.54SOP4	2.54SOP6	2.54SOP8	SSOP4	USOP4	VSON4	S-VSON4	
Taping	(TP1) (TP5)	(TP4)	(TP)	(TP)	(TPL) (TPR)	(TP)	(TP)	(TP)	(TP15)	(TP15)	(TP)	(TP)	
Tape Dimensions	A	10.4 ± 0.1	12.3 ± 0.1	10.4 ± 0.1	12.3 ± 0.1	4.2 ± 0.1	4.3 ± 0.1	7.5 ± 0.1	7.5 ± 0.1	2.35 ± 0.2	2.6 ± 0.1	1.6 ± 0.1	1.6 ± 0.1
	B	(*1)	(*1)	5.1 ± 0.1	5.1 ± 0.1	7.6 ± 0.1	7.5 ± 0.1	6.7 ± 0.1	10.5 ± 0.1	4.5 ± 0.1	3.55 ± 0.1	3.0 ± 0.1	2.25 ± 0.1
	C	16.3 ± 0.3		16.3 ± 0.3		12.3 ± 0.3	12.0 ± 0.3	16.0 ± 0.3		12.0 ± 0.3		8.0 ± 0.3	8.0 ± 0.2
	D	7.5 ± 0.1		7.5 ± 0.1		5.5 ± 0.1	5.5 ± 0.1	7.5 ± 0.1		5.5 ± 0.1		3.5 ± 0.1	
	F	12.0 ± 0.1	16.0 ± 0.1	12.0 ± 0.1	16.0 ± 0.1	8.0 ± 0.1	8.0 ± 0.1	12.0 ± 0.1		4.0 ± 0.1		4.0 ± 0.1	
	K	4.55 ± 0.2		4.55 ± 0.2		3.15 ± 0.2	2.6 ± 0.2	2.5 ± 0.2	2.4 ± 0.2	2.4 ± 0.2	(2.0 ± 0.1)	(1.8 ± 0.1)	
	K0	4.1 ± 0.1		4.1 ± 0.1		2.7 ± 0.1	2.4 ± 0.1	2.3 ± 0.1	2.2 ± 0.1	2.1 ± 0.1	1.95 ± 0.1	1.5 ± 0.1	1.85 ± 0.1
	t	0.4 ± 0.05		0.4 ± 0.05		0.3 ± 0.05	0.3 ± 0.05			0.3 ± 0.05	0.3 ± 0.1	0.2 ± 0.05	0.2 ± 0.05
Reel Dimensions	a	φ 380 ± 2		φ 380 ± 2		φ 380 ± 2		φ 330 ± 2		φ 180 ⁺⁰ ₋₄		φ 180 ± 3	
	b	φ 80 ± 1		φ 80 ± 1		φ 80 ± 1		φ 80 ± 1		φ 60 ± 1		φ 60 ± 1	
	w1	17.5 ± 0.5		17.5 ± 0.5		13.5 ± 0.5	13.5 ± 0.5	17.5 ± 0.5		13.0 ± 0.3		9.0 ± 0.3	
	w2	21.5 ± 1.0		21.5 ± 1.0		17.5 ± 1.0	17.5 ± 1.0	21.5 ± 1.0		15.4 ± 1.0		11.4 ± 1.0	

Package	SO4	4 pin/5 pin SO6	SO8	SO16	4 pin SO6L	SO6L	SO8L	SO16L	SO6L (LF4)	SO8L (LF4)		
Taping	(TP)	(TPL) (TPR)	(TP)	(TP)	(TPL) (TPR)	(TP)	(TL)	(TP)	(TP4)	(TP4)		
Tape Dimensions	A	3.1 ± 0.1	4.0 ± 0.1	6.5 ± 0.1	7.5 ± 0.1	4.24 ± 0.1	10.4 ± 0.1	11.55 ± 0.1	10.4 ± 0.1	11.55 ± 0.1	11.55 ± 0.1	
	B	7.5 ± 0.1	7.6 ± 0.1	5.6 ± 0.1	10.5 ± 0.1	10.4 ± 0.1	4.24 ± 0.1	6.35 ± 0.1	10.7 ± 0.1	4.24 ± 0.1	6.35 ± 0.1	
	C	12.0 ± 0.3			16.0 ± 0.3	16.0 ± 0.3				16.0 ± 0.3		
	D	5.5 ± 0.1			7.5 ± 0.1	7.5 ± 0.1				7.5 ± 0.1		
	F	8.0 ± 0.1			12.0 ± 0.1	8.0 ± 0.1	12.0 ± 0.1	16.0 ± 0.1	12.0 ± 0.1	16.0 ± 0.1		
	K	3.15 ± 0.2	2.9 ± 0.2	3.4 ± 0.2	2.6 ± 0.2	2.7 ± 0.1	(2.7 ± 0.1)	2.8 ± 0.1	(2.7 ± 0.1)	2.7 ± 0.1	2.8 ± 0.1	
	K0	2.3 ± 0.1	2.6 ± 0.1	3.1 ± 0.1	2.2 ± 0.1	2.4 ± 0.1				2.4 ± 0.1		
	t	0.3 ± 0.05				0.3 ± 0.05				0.3 ± 0.05		
Reel Dimensions	a	φ 330 ± 2				φ 330 ± 2				φ 330 ± 2		
	b	φ 80 ± 1				φ 100 ± 1				φ 100 ± 1		
	w1	13.5 ± 0.5			17.5 ± 0.5	17.4 ± 1.0				17.4 ± 1.0		
	w2	17.5 ± 1.0			21.5 ± 1.0	21.4 ± 1.0				21.4 ± 1.0		

(*1): Typical devices

DIP4	5.1 ± 0.1
DIP6	7.6 ± 0.1
DIP8	10.1 ± 0.1 (TP4) is not available.

■ Photocouplers direction on Tape

Photocouplers are put in cavity, as shown below.

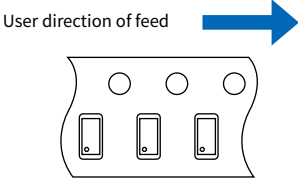
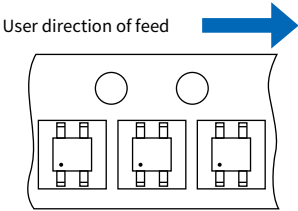
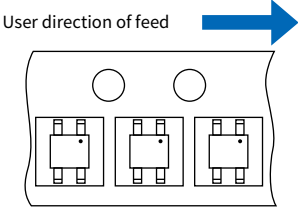
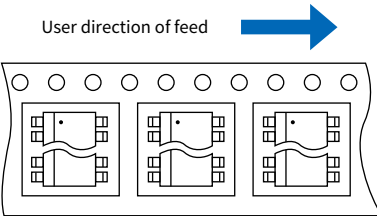
Device Orientation on Tape	Tape Option	Package Type	Packing Quantity (pcs/reel)
	TP	S-VSON4	3,000
		VSON4	3,000
	TP15	USOP4	1,500
		SSOP4	1,500
	TP	2.54SOP4	2,500
		SO4	2,500
	TPL	4 pin/5 pin MFSOP6	3,000
		SO4	2,500
		4 pin/5 pin SO6	3,000
		4 pin SO6L	3,000
	TPR	4 pin/5 pin MFSOP6	3,000
		SO4	2,500
		4 pin/5 pin SO6	3,000
		4 pin SO6L	3,000
		2.54SOP6	2,500
	TP	2.54SOP8	2,500
		SO8	2,500
		SO16	2,000
		SO6L	1,500
		SO8L	1,500
	TL	SO8L	1,500
	TP	SO16L	1,500
	TP4	SO6L (LF4)	1,500
		SO8L (LF4)	1,500
	TP	SDIP6	1,500
		SDIP6 (F type)	1,000
	TP1	DIP (LF1)	1,500
	TP4	DIP (LF4)	1,000
	TP5	DIP (LF5)	1,500

The standard taping specification is presented herein. The taping specification and name for some products may be different. For details, see technical datasheets for individual products.

Projected Operating Life of Photocouplers

Toshiba photocouplers use one of four types of LEDs and a projection of the operating life has been estimated for each LED. See the following pages for the projected operating life data for LEDs and the types of LEDs used in each photocoupler. The projected operating life data should be considered only as references as they are estimates for a single production lot based on long-term data.

▶ (1) Projected Operating Life Based on LED Efficiency Degradation

	Projected Operating Life ⁽¹⁾		Photocouplers
	F50% operating life ⁽²⁾	F0.1% operating life ⁽³⁾	
① GaAs LED	400,000 h	70,000 h	Mainly for phototransistor output devices and phototriac output devices
② GaAlAs(SH) LED	200,000 h	40,000 h	Mainly for photo-IC couplers
③ GaAlAs(DH) LED	350,000 h	70,000 h	Mainly for photorelays (MOSFET output), photovoltaic couplers and photo-IC couplers
④ GaAlAs (MQW) LED	Ask your local Toshiba sales representative.		Mainly for photo-IC couplers

(1) Ta = 40 °C, If = 20 mA, failure criteria: degradation rate $\Delta P_o < -30\%$

(2) Cumulative failure rate 50%: Time period until the projected long-term light output degradation curve of the average light output change (\bar{X}) shown on pages 73 to 75 reaches the failure criteria.

(3) Cumulative failure rate 0.1%: Time period until the projected long-term light output degradation curve of $\bar{X} - 3\sigma$ shown on pages 73 to 75 reaches the failure criteria.

* SH : Single Hetero-junction

* DH : Double Hetero-junction

* MQW : Multiple Quantum Well

▶ (2) Reading the Projected LED Operating Life Graph

The operating life of the GaAs LED is estimated based on the data shown on page 20. Here is an example of how to read an operating life, assuming that the ambient temperature (T_a) is 40°C and that the failure criterion is a 30% decrease in light output. Suppose that the initial LED current, I_F , is 20 mA.

Since the horizontal axis of the failure criteria graph is the reciprocal of absolute temperature, it is necessary to convert the ambient temperature (T_a) to the reciprocal of absolute temperature (T):

$$T = \frac{1}{T_a + 273.15} = \frac{1}{40 + 273.15} \doteq 3.19 \times 10^{-3}$$

The graph shows the projected lifetimes for F50% and F0.1% cumulative failure probabilities in solid and dashed lines respectively. Normally, it is recommended to use F0.1% lines.

As $X = 3.19$, its intersection with the $I_F = 20\text{ mA}$ line for F0.1% is approximately 80,000 hours. (This figure is for reference only.)

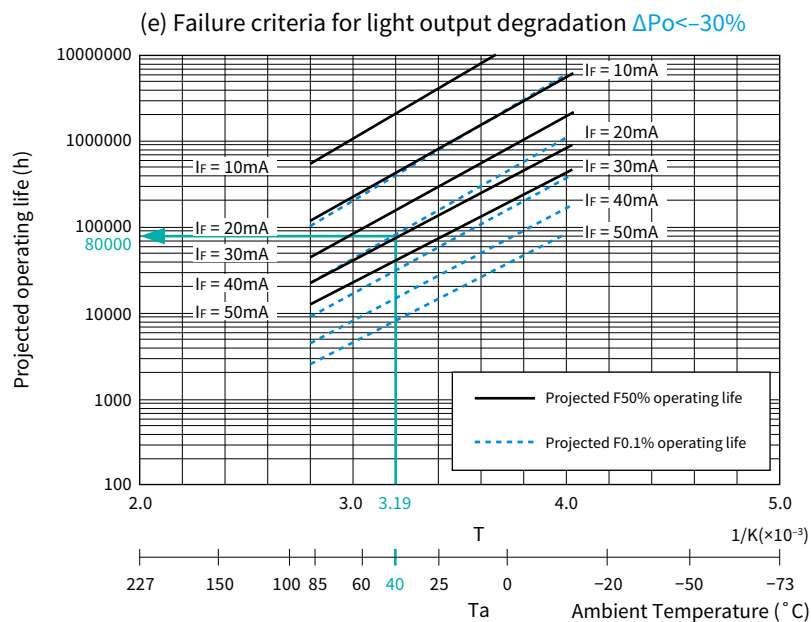

You can also estimate the projected operating lifetimes from the projected light output degradation data.

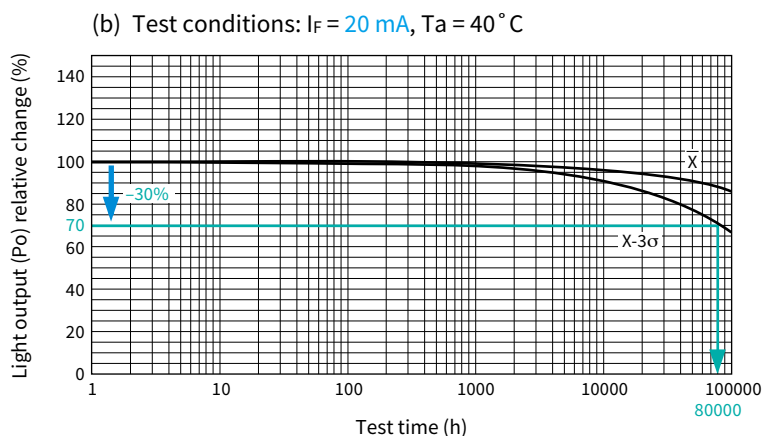

▶ (3) Projected Operating Life Data

① GaAs LED

■ Projected Light Output Degradation Data

(a) Test conditions: $I_F = 50 \text{ mA}$, $T_a = 40^\circ \text{C}$

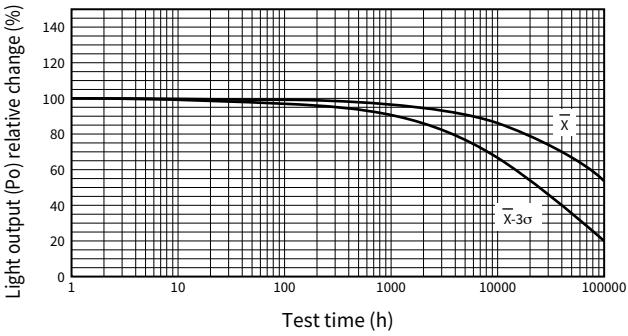

(b) Test conditions: $I_F = 20 \text{ mA}$, $T_a = 40^\circ \text{C}$

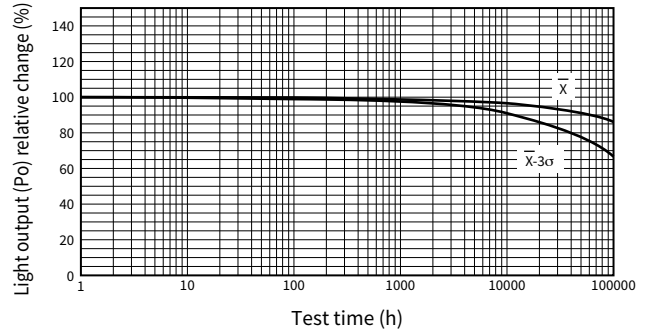

(c) Test conditions: $I_F = 10 \text{ mA}$, $T_a = 40^\circ \text{C}$

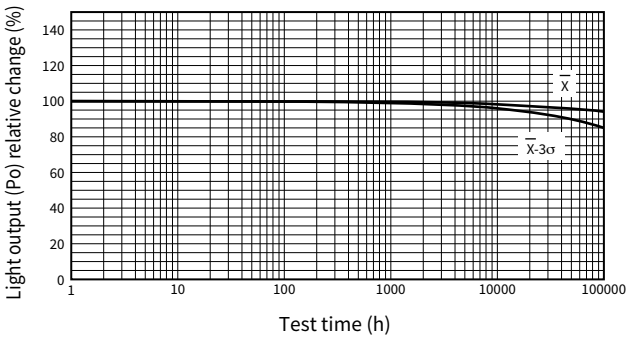

■ Projected Operating Life Data

(d) Failure criteria for light output degradation $\Delta P_o < -50\%$

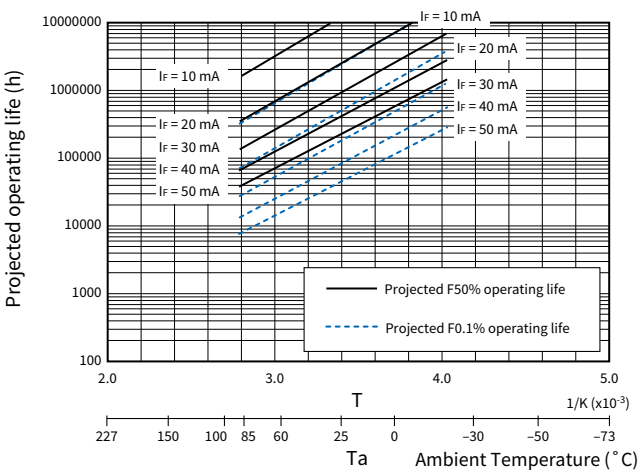

(e) Failure criteria for light output degradation $\Delta P_o < -30\%$

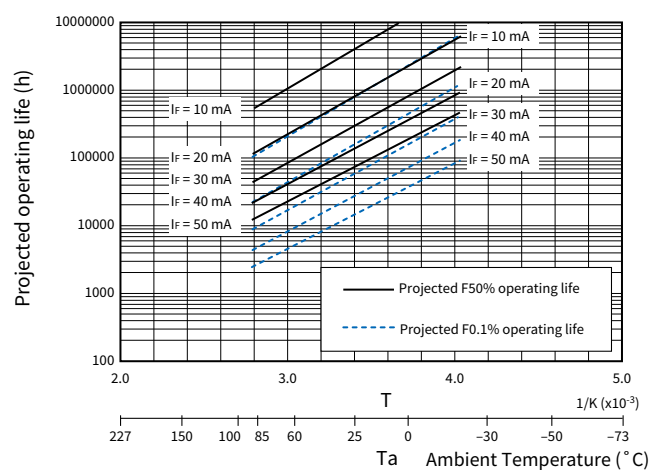

The above operating life data are estimates extrapolated from long-term light output degradation over a single wafer lot and are shown as reference only. Operating conditions exceeding the maximum ratings are not guaranteed.

② GaAlAs (SH) LED

Projected Light Output Degradation Data

(a) Test conditions: $I_F = 50 \text{ mA}$, $T_a = 40^\circ \text{C}$

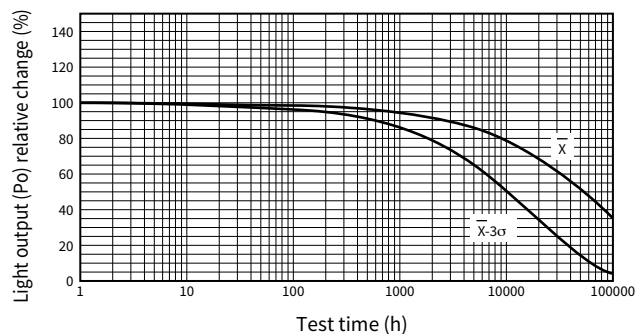

(b) Test conditions: $I_F = 20 \text{ mA}$, $T_a = 40^\circ \text{C}$

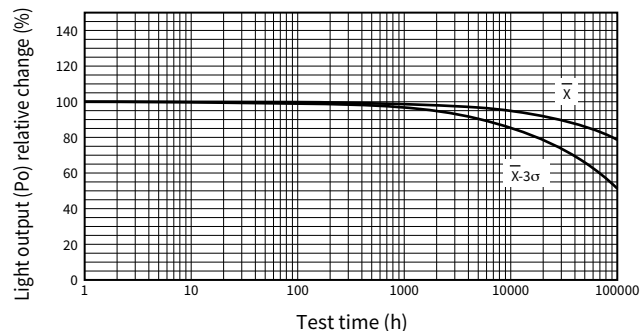

(c) Test conditions: $I_F = 10 \text{ mA}$, $T_a = 40^\circ \text{C}$

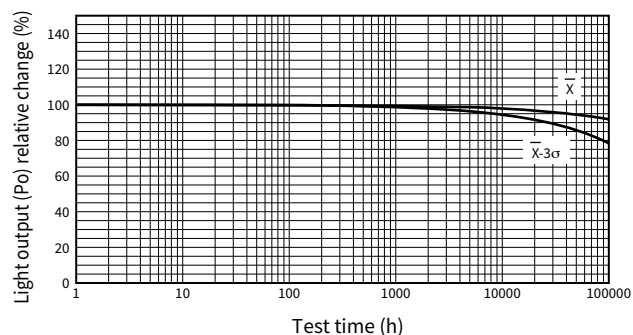

Projected Operating Life Data

(d) Failure criteria for light output degradation $\Delta P_o < -50\%$

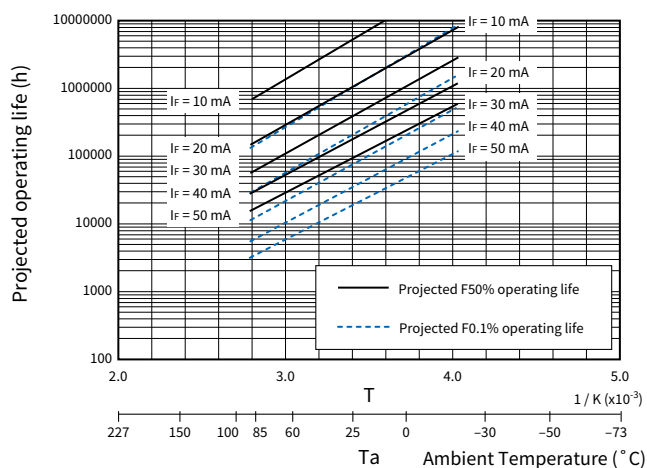

(e) Failure criteria for light output degradation $\Delta P_o < -30\%$

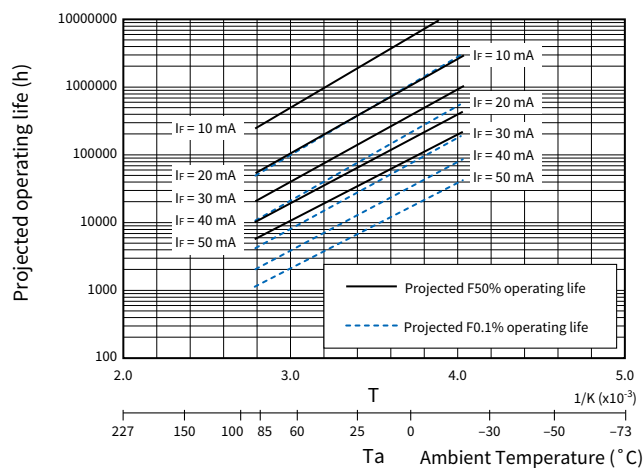

The above operating life data are estimates extrapolated from long-term light output degradation over a single wafer lot and are shown as reference only. Operating conditions exceeding the maximum ratings are not guaranteed.

③ GaAlAs (DH) LED

Projected Light Output Degradation Data

(a) Test conditions: $I_F = 50 \text{ mA}$, $T_a = 40^\circ \text{C}$

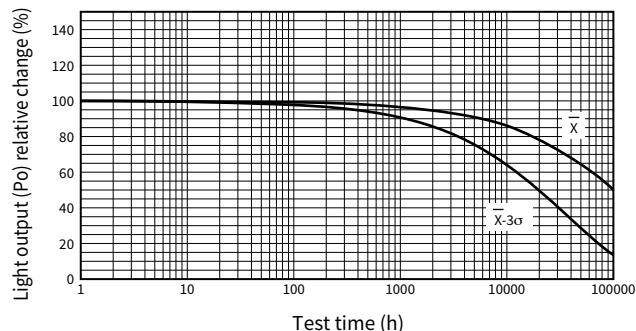

(b) Test conditions: $I_F = 20 \text{ mA}$, $T_a = 40^\circ \text{C}$

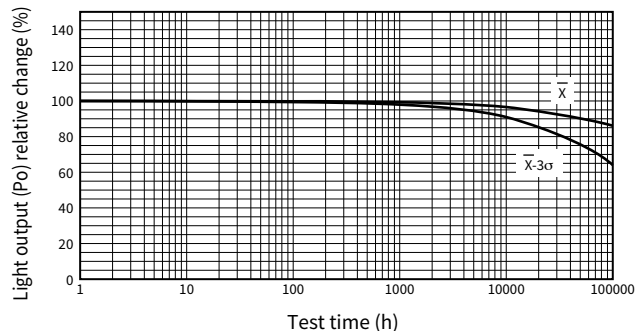

(c) Test conditions: $I_F = 10 \text{ mA}$, $T_a = 40^\circ \text{C}$

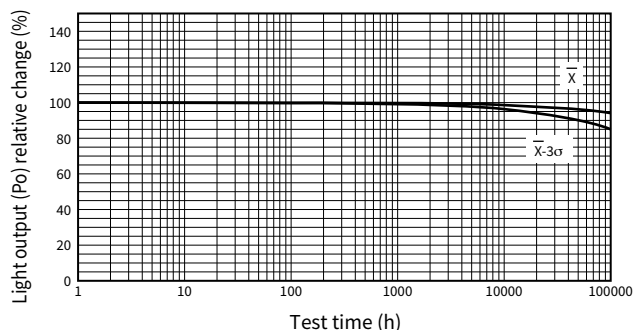

Projected Operating Life Data

(d) Failure criteria for light output degradation $\Delta P_o < -50\%$

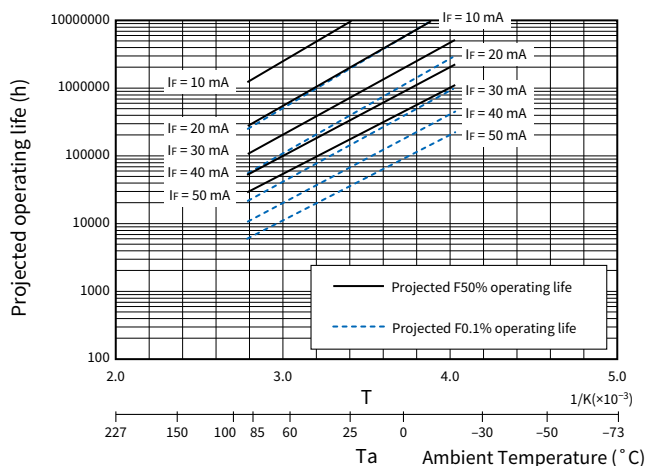

(e) Failure criteria for light output degradation $\Delta P_o < -30\%$

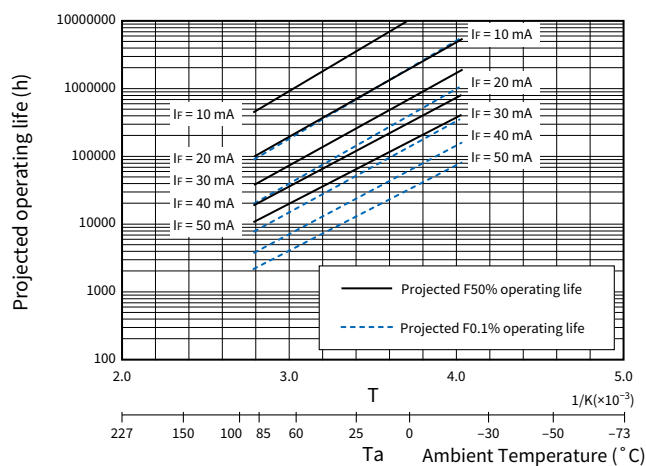

The above operating life data are estimates extrapolated from long-term light output degradation over a single wafer lot and are shown as reference only. Operating conditions exceeding the maximum ratings are not guaranteed.

④ GaAlAs (MQW) LED

Projected Light Output Degradation and Operating Life Data

Toshiba is now preparing the light output degradation and operating life data for GaAlAs (MQW) LEDs. These data are available for individual LEDs. Ask your local Toshiba sales representative.

▶ (4) LEDs Used in Photocouplers

LED: ① GaAs ② GaAlAs (SH) ③ GaAlAs (DH) ④ GaAlAs (MQW)

Photocouplers	LED	Photocouplers	LED	Photocouplers	LED	Photocouplers	LED	Photorelays	LED
TLP1xx		TLP7xx		TLP2408	④	TLP5771	④	TLP3109A	④
TLP109	④	TLP700A	④	TLP2409	④	TLP5772	④	TLP3122	①
TLP116A	④	TLP700H	④	TLP2418	④	TLP5774	④	TLP3122A	④
TLP118	④	TLP701A	④	TLP2451A	④	TLP5832	④	TLP3123	③
TLP148G	①	TLP701H	④	TLP2466	④	TLP7xxx		TLP3125	①
TLP151A	④	TLP705A	④	TLP2468	④	TLP7820	④	TLP3127	③
TLP152	④	TLP714	④	TLP25xx		TLP7830	④	TLP314x Series	④
TLP155E	④	TLP715	②	TLP2530	②	TLP7920	④	TLP3203	①
TLP163J	①	TLP718	②	TLP2531	②	TLP7930	④	TLP321x Series	①
TLP182	④	TLP719	②	TLP26xx		TLX9xxx		TLP3220	①
TLP183	④	TLP731	①	TLP2662	④	TLX9000	④	TLP3230	①
TLP184(SE)	①	TLP732	①	TLP27xx		TLX9175J	④	TLP3231	①
TLP185(SE)	①	TLP748J	①	TLP2701	④	TLX9185A	④	TLP3240	③
TLP187	④	TLP754	④	TLP2703	④	TLX9291A	④	TLP3241	③
TLP188	④	TLP759	②	TLP2704	④	TLX9300	④	TLP3250	③
TLP190B	③	TLP785	①	TLP2710	④	TLX9304	④	TLP3275	①
TLP191B	③	TLP21xx		TLP2719	④	TLX9310	④	TLP33xx Series	①
TLP2xx		TLP2105	②	TLP2735	④	TLX9376	④	TLP34xx Series	④
TLP250H	④	TLP2108	②	TLP2745	④	TLX9378	④	TLP35xx Series	③
TLP265J	④	TLP2110	④	TLP2748	④	TLX9905	④	TLP3543A	④
TLP266J	④	TLP2118E	④	TLP2761	④	TLX9906	④	TLP3545A	④
TLP267J	④	TLP2160	④	TLP2766	④	Other		TLP3546A	④
TLP268J	④	TLP2161	④	TLP2766A	④	TLPN137	④	TLP3547	④
TLP290(SE)	①	TLP2167	④	TLP2767	④	Photorelays	LED	TLP3548	④
TLP290-4	①	TLP2168	④	TLP2768	④	TLP170 Seires	①	TLP3549	④
TLP291(SE)	①	TLP22xx		TLP2768A	④	TLP171 Series	④	TLP3553A	④
TLP291-4	①	TLP2210	④	TLP2770	④	TLP172 Series	①	TLP3555A	④
TLP292	④	TLP2261	④	TLP29xx		TLP174 Series	①	TLP3556A	④
TLP292-4	④	TLP2270	④	TLP2955	④	TLP174G Series	①	TLP3558A	④
TLP293	④	TLP23xx		TLP2958	④	TLP175A	④	TLP38xx Series	④
TLP293-4	④	TLP2301	④	TLP2962	④	TLP176 Series	①	TLP4xxx Series	①
TLP3xx		TLP2303	④	TLP30xx		TLP176AM	④		
TLP350H	④	TLP2309	④	TLP3052A	①	TLP179D	①		
TLP351A	④	TLP2310	④	TLP3062A	①	TLP192 Series	①		
TLP351H	④	TLP2312	④	TLP3064(S)	③	TLP197 Series	①		
TLP352	④	TLP2345	④	TLP3073	①	TLP199D	①		
TLP358H	④	TLP2348	④	TLP3083	①	TLP200D	①		
TLP360J	①	TLP2355	④	TLP39xx		TLP202 Series	①		
TLP361J	①	TLP2358	④	TLP3902	①	TLP206 Series	①		
TLP363J	①	TLP2361	④	TLP3904	①	TLP222 Series	①		
TLP383	④	TLP2362	④	TLP3905	④	TLP224G Series	①		
TLP385	①	TLP2363	④	TLP3906	④	TLP225A	①		
TLP387	④	TLP2366	④	TLP3914	③	TLP227 Series	①		
TLP388	④	TLP2367	④	TLP3924	③	TLP228 Series	①		
TLP5xx		TLP2368	④	TLP5xxx		TLP240 Series	④		
TLP548J	①	TLP2370	④	TLP5214	④	TLP241A	④		
TLP549J	①	TLP2372	④	TLP5214A	④	TLP592 Series	①		
TLP590B	③	TLP2391	④	TLP5231	④	TLP597 Series	①		
TLP591B	③	TLP2395	④	TLP5701	④	TLP598 Series	③		
TLP6xx		TLP2398	④	TLP5702	④	TLP797 Series	①		
TLP628M	⑤	TLP24xx		TLP5711H	④	TLP798GA	③		
TLP663J(S)	①	TLP2403	④	TLP5751	④	TLP310x Series	③		
TLP668J(S)	③	TLP2404	④	TLP5752	④	TLP3106A	④		
TLP669L(S)	④	TLP2405	④	TLP5754	④	TLP3107A	④		

Photocouplers and Photorelays

Mar. 2020

BCJ0117C

RESTRICTIONS ON PRODUCT USE

Toshiba Corporation and its subsidiaries and affiliates are collectively referred to as "TOSHIBA". Hardware, software and systems described in this document are collectively referred to as "Product".

- ▶ TOSHIBA reserves the right to make changes to the information in this document and related Product without notice.
- ▶ This document and any information herein may not be reproduced without prior written permission from TOSHIBA. Even with TOSHIBA's written permission, reproduction is permissible only if reproduction is without alteration/omission.
- ▶ Though TOSHIBA works continually to improve Product's quality and reliability, Product can malfunction or fail. Customers are responsible for complying with safety standards and for providing adequate designs and safeguards for their hardware, software and systems which minimize risk and avoid situations in which a malfunction or failure of Product could cause loss of human life, bodily injury or damage to property, including data loss or corruption. Before customers use the Product, create designs including the Product, or incorporate the Product into their own applications, customers must also refer to and comply with (a) the latest versions of all relevant TOSHIBA information, including without limitation, this document, the specifications, the data sheets and application notes for Product and the precautions and conditions set forth in the "TOSHIBA Semiconductor Reliability Handbook" and (b) the instructions for the application with which the Product will be used with or for. Customers are solely responsible for all aspects of their own product design or applications, including but not limited to (a) determining the appropriateness of the use of this Product in such design or applications; (b) evaluating and determining the applicability of any information contained in this document, or in charts, diagrams, programs, algorithms, sample application circuits, or any other referenced documents; and (c) validating all operating parameters for such designs and applications. **TOSHIBA ASSUMES NO LIABILITY FOR CUSTOMERS' PRODUCT DESIGN OR APPLICATIONS.**
- ▶ **PRODUCT IS NEITHER INTENDED NOR WARRANTED FOR USE IN EQUIPMENTS OR SYSTEMS THAT REQUIRE EXTRAORDINARILY HIGH LEVELS OF QUALITY AND/OR RELIABILITY, AND/OR A MALFUNCTION OR FAILURE OF WHICH MAY CAUSE LOSS OF HUMAN LIFE, BODILY INJURY, SERIOUS PROPERTY DAMAGE AND/OR SERIOUS PUBLIC IMPACT ("UNINTENDED USE").** Except for specific applications as expressly stated in this document, Unintended Use includes, without limitation, equipment used in nuclear facilities, equipment used in the aerospace industry, lifesaving and/or life supporting medical equipment, equipment used for automobiles, trains, ships and other transportation, traffic signaling equipment, equipment used to control combustions or explosions, safety devices, elevators and escalators, and devices related to power plant. **IF YOU USE PRODUCT FOR UNINTENDED USE, TOSHIBA ASSUMES NO LIABILITY FOR PRODUCT.** For details, please contact your TOSHIBA sales representative or contact us via our website.
- ▶ Do not disassemble, analyze, reverse-engineer, alter, modify, translate or copy Product, whether in whole or in part.
- ▶ Product shall not be used for or incorporated into any products or systems whose manufacture, use, or sale is prohibited under any applicable laws or regulations.
- ▶ The information contained herein is presented only as guidance for Product use. No responsibility is assumed by TOSHIBA for any infringement of patents or any other intellectual property rights of third parties that may result from the use of Product. No license to any intellectual property right is granted by this document, whether express or implied, by estoppel or otherwise.
- ▶ **ABSENT A WRITTEN SIGNED AGREEMENT, EXCEPT AS PROVIDED IN THE RELEVANT TERMS AND CONDITIONS OF SALE FOR PRODUCT, AND TO THE MAXIMUM EXTENT ALLOWABLE BY LAW, TOSHIBA (1) ASSUMES NO LIABILITY WHATSOEVER, INCLUDING WITHOUT LIMITATION, INDIRECT, CONSEQUENTIAL, SPECIAL, OR INCIDENTAL DAMAGES OR LOSS, INCLUDING WITHOUT LIMITATION, LOSS OF PROFITS, LOSS OF OPPORTUNITIES, BUSINESS INTERRUPTION AND LOSS OF DATA, AND (2) DISCLAIMS ANY AND ALL EXPRESS OR IMPLIED WARRANTIES AND CONDITIONS RELATED TO SALE, USE OF PRODUCT, OR INFORMATION, INCLUDING WARRANTIES OR CONDITIONS OF MERCHANTABILITY, FITNESS FOR A PARTICULAR PURPOSE, ACCURACY OF INFORMATION, OR NONINFRINGEMENT.**
- ▶ GaAs (Gallium Arsenide) is used in Product. GaAs is harmful to humans if consumed or absorbed, whether in the form of dust or vapor. Handle with care and do not break, cut, crush, grind, dissolve chemically or otherwise expose GaAs in Product.
- ▶ Do not use or otherwise make available Product or related software or technology for any military purposes, including without limitation, for the design, development, use, stockpiling or manufacturing of nuclear, chemical, or biological weapons or missile technology products (mass destruction weapons). Product and related software and technology may be controlled under the applicable export laws and regulations including, without limitation, the Japanese Foreign Exchange and Foreign Trade Law and the U.S. Export Administration Regulations. Export and re-export of Product or related software or technology are strictly prohibited except in compliance with all applicable export laws and regulations.
- ▶ Please contact your TOSHIBA sales representative for details as to environmental matters such as the RoHS compatibility of Product. Please use Product in compliance with all applicable laws and regulations that regulate the inclusion or use of controlled substances, including without limitation, the EU RoHS Directive. **TOSHIBA ASSUMES NO LIABILITY FOR DAMAGES OR LOSSES OCCURRING AS A RESULT OF NONCOMPLIANCE WITH APPLICABLE LAWS AND REGULATIONS.**

Photocouplers and Photorelays

TOSHIBA

Toshiba Electronic Devices & Storage Corporation

Website: <https://toshiba.semicon-storage.com/>