

M4G Group (1)
Application Note
High Speed DMA Controller
(HDMAC-A)
Memory to TSPI

Outlines

This application note is a reference material for developing products that the function of transferring data from memory to peripheral device using high speed DMA controller (HDMAC) of M4G group (1). This document helps the user check operation of the product and develop its program.

Target sample program: HDMA_TSPI_MEM

Table of Contents

Outlines.....	1
Table of Contents.....	2
1. Preface	3
2. Reference Document	4
3. Function to Use.....	4
4. Target Device.....	4
5. Operation Confirmation Condition	5
6. Evaluation Board Setting.....	6
7. Operation of Evaluation Board	6
8. Outline of HDMAC Function	7
9. Sample Program	8
9.1. Initialization	8
9.2. Sample Program Main Operation	8
9.3. HDMA_TSPI_MEM Setting.....	8
9.4. Output Example of Sample Program.....	9
9.4.1. Setting Example of Terminal Software.....	9
9.5. Operating Flow of Sample Program	10
10. Precaution.....	25
11. Revision History	25
RESTRICTIONS ON PRODUCT USE	26

1. Preface

This is a sample program used for operation check of the transferring operation from memory using HDMAC to peripheral functions.
 The received data is directly transferred and output from memory to a peripheral device (TSPI), not via CPU.

Structure diagram of Sample program

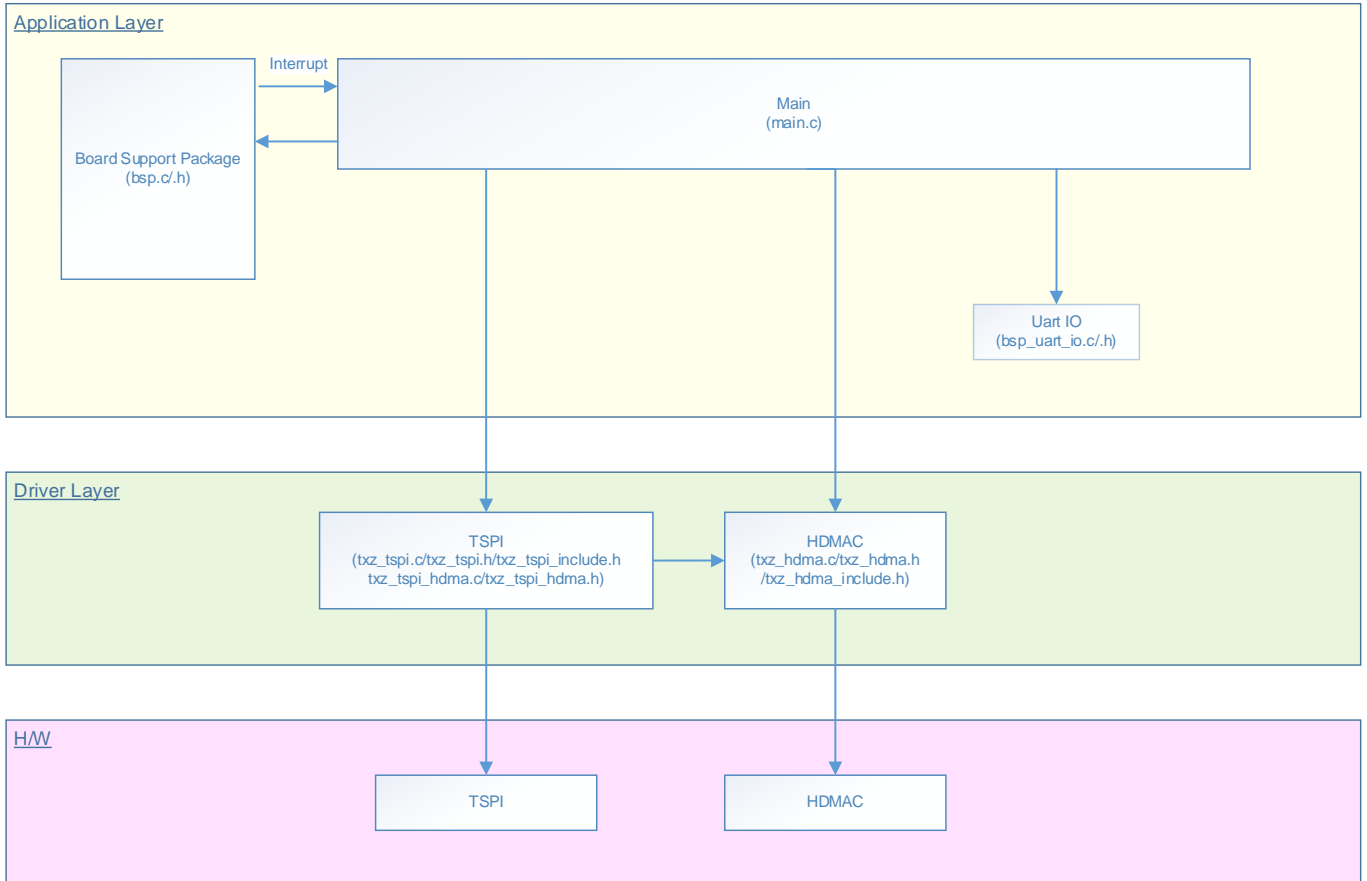

2. Reference Document

- Datasheet
TMPM4G group (1) datasheet Rev1.0 (Japanese edition)
- Reference manual
High Speed DMA Controller (HDMAC-A) Rev1.0 (Japanese edition)
Serial Peripheral Interface (TSPI-C) Rev1.0 (Japanese edition)
Asynchronous Serial Communication Circuit (UART-C) Rev3.0 (Japanese edition)
- Application Note
M4G Group (1) Application Note Startup (CMSIS System & Clock Configuration) Rev1.0
- Other reference document
TMPM4G (1) Group Peripheral Driver User Manual (Doxygen)

3. Function to Use

IP	Channel	Port	Function Operation mode
Asynchronous Serial Communication Circuit	ch0	PE2(UT0RXD) PE3(UT0TXDA)	UART mode
Serial Peripheral Interface	ch2	PA4(TSPI2TXD) PA5(TSPI2RXD) PA6(TSPI2SCK)	SPI mode
High Speed DMA Controller	ch0 (transfer) ch3 (request)	-	Memory to Peripheral Device (Register) Burst transfer

4. Target Device

The target devices of this application note are as follows;

TMPM4G9F15FG	TMPM4G9F10FG	TMPM4G9FEFG	TMPM4G9FDFG
TMPM4G9F15XBG	TMPM4G9F10XBG	TMPM4G9FEXBG	TMPM4G9FDXBG
TMPM4G8F15FG	TMPM4G8F10FG	TMPM4G8FEFG	TMPM4G8FDFG
TMPM4G8F15XBG	TMPM4G8F10XBG	TMPM4G8FEXBG	TMPM4G8FDXBG
	TMPM4G7F10FG	TMPM4G7FEFG	TMPM4G7FDFG
	TMPM4G6F10FG	TMPM4G6FEFG	TMPM4G6FDFG

*This sample program operates on the evaluation board of TMPM4G9F15FG.

If other function than the TMPM4G9F15 one is checked, it is necessary that CMSIS Core related files (C startup file and I/O header file) should be changed properly.

The BSP related file is dedicated to the evaluation board (TMPM4G9F15). If other function than the TMPM4G9F15 one is checked, the BSP related file should be changed properly.

5. Operation Confirmation Condition

Used microcontroller	TMPM4G9F15FG
Used board	TMPM4G9F15FGEvaluation Board by Sensys
Unified development environment	IAR Embedded Workbench for ARM 8.11.2.13606
Unified development environment	µVision MDK Version 5.24.2.0
Terminal software	Tera Term V4.96
Sample program	V1000

Evaluation board (TMPM4G9F15FG Evaluation Board) Top view

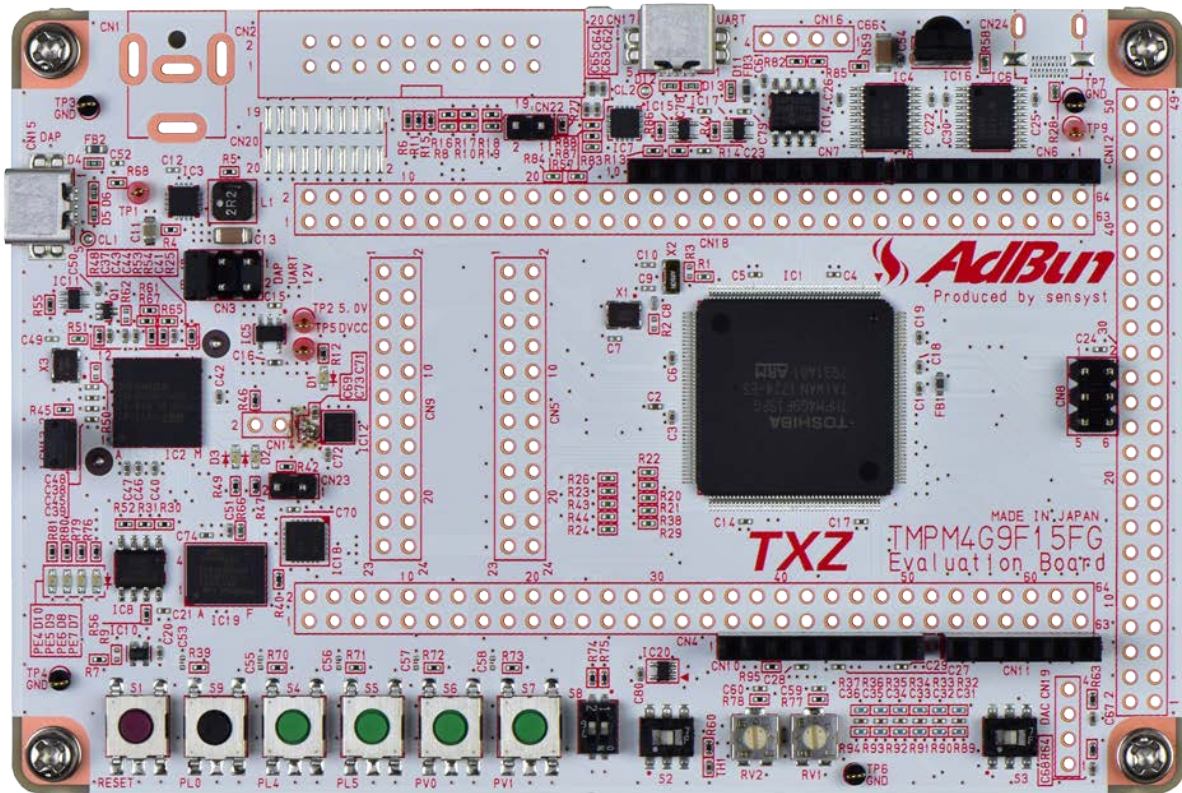

6. Evaluation Board Setting

The following pin connections should be done on the evaluation board.

CN5		
Board function	Through-hole No.	Through-hole No.
USB UART conversion	1:USB_UT_RX	2:PE2
USB UART conversion	3:USB_UT_TX	4:PE3

CN18		
Board function	Through-hole No.	Through-hole No.
TSPI (TXD-RXD)	35:PA4	37:PA5

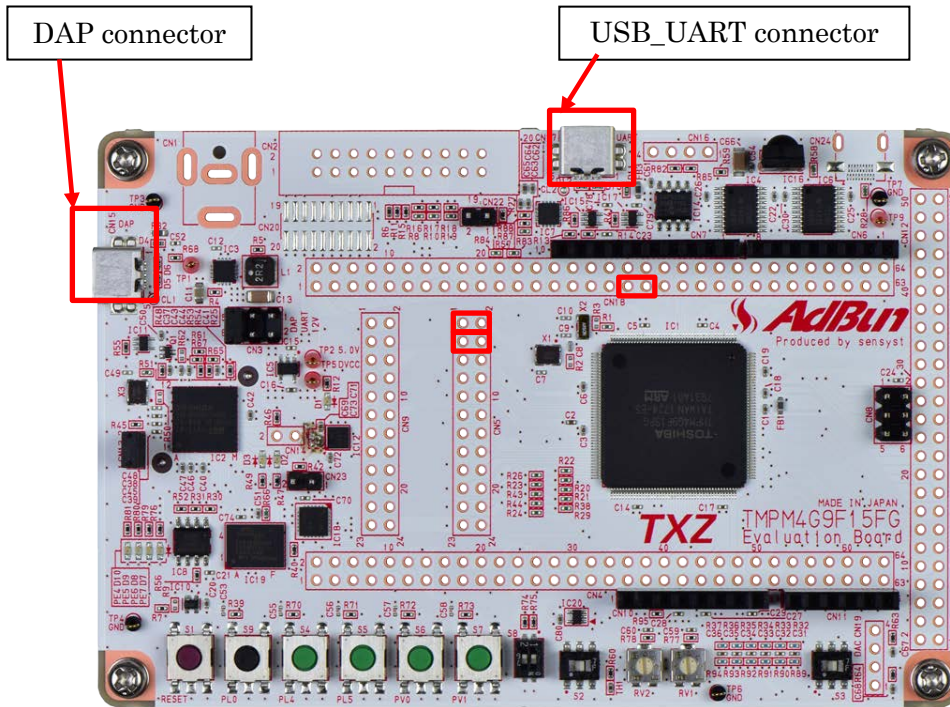

7. Operation of Evaluation Board

PC and the USB_UART are connected for communication with the terminal software.

Enters an arbitrary character to the terminal software.

Receives the entered value via UART. The received data is transferred from memory to the TSPI, and is output to the terminal software via UART.

8. Outline of HDMAC Function

The functions of HDMAC per unit are shown in the following table.

Function category	Function	Description
Transfer request	Peripheral function	Transfer request from a peripheral device (Single transfer request/Burst transfer request)
	Software	Transfer request by software (Single transfer request/Burst transfer request)
	Request channel	16 channels (Transfer request count by peripheral devices)
Transfer mode	Single transfer	Data transfer is executed once.
	Burst transfer	Data transfer is executed once or multiple times Burst size: 1, 4, 8, 16, 32, 64, 128, and 256 beats Continuous data transfer of the specified burst count is possible without releasing the bus using the lock transfer setting.
	Chain transfer	Continuous data transfer is possible using discontinuous addresses according to Linked List Item (LLI).
Transfer type	Transfer source -> Transfer destination	Peripheral device (Register) -> Memory Peripheral device (Register) -> Peripheral device (Register) Memory -> Peripheral device (Register) Memory -> Memory (start up by only software)
Transfer control	Transfer channel	2 channels (ch 0 and ch 1)
	Transfer address	Addresses of the transfer source and destination are set. Selection of the increment of the address or fixed address for either the transfer source or destination.
	Transfer data size	8 bits, 16 bits, or 32 bits The sizes of the transfer source and destination can be set independently.
	Priority	ch 0 > ch 1 (Fixed in the unit.) Unit A > Unit B (For the integrated units, refer to "Product Information".)
	FIFO	4 Words x 2 ch (1 Word = 32 bits)
Transfer count	Transfer count	4095 at maximum Infinite count transfers can be done using LLI.
Endian	Little endian	-
Interrupt	Transfer completion interrupt	Transfer completion interrupt (INTHDMACxTC) is generated when a transfer completes.
	Error interrupt	Error interrupt (INTHDMACxERR) is generated when a bus error or a memory protection error is detected during data transfer.

9. Sample Program

The sample program transfers the data received from the terminal software via UART to memory. The received data are transmitted from memory using the loopback of TSPI. The received data using the loopback of TSPI are transferred to memory, and it will be output from memory to the terminal software via UART. This sample program performs the transmission from memory to TSPI via HDMAC.

9.1. Initialization

The following initialization is done after power is supplied.
The initialization of each clock setting and the setting of the watchdog timer are done.

9.2. Sample Program Main Operation

The initialization of BSP is executed.
The initialization of driver is executed.
The initialization of applications is executed.
UART and TSPI are set within application initialization.

Go to main processing and make HDMAC setting within main program processing.
A message "Input =" prompting input to terminal software is output.
Wait until input comes from terminal software.
The input data is saved in memory via UART.
The DMAC transferred data is transmitted and received by TSPI.
The saved data will be displayed in the terminal software after "transdata =" via UART.
If the input character exceeds 10 byte (including a line feed code), an input error is output to the terminal software.

9.3. HDMA_TSPI_MEM Setting

The transfer channels of the sample program are changed with the following parameter(s):
Change of CFG_DMA_CH in the main.c

9.4. Output Example of Sample Program

When the sample program is operated, the transferred result by HDMAC are output as follows:

```
Input = 12345678  
transdata = 12345678  
  
Input =
```

9.4.1. Setting Example of Terminal Software

The operation of the terminal software (Tera Term) has been checked with the following settings.

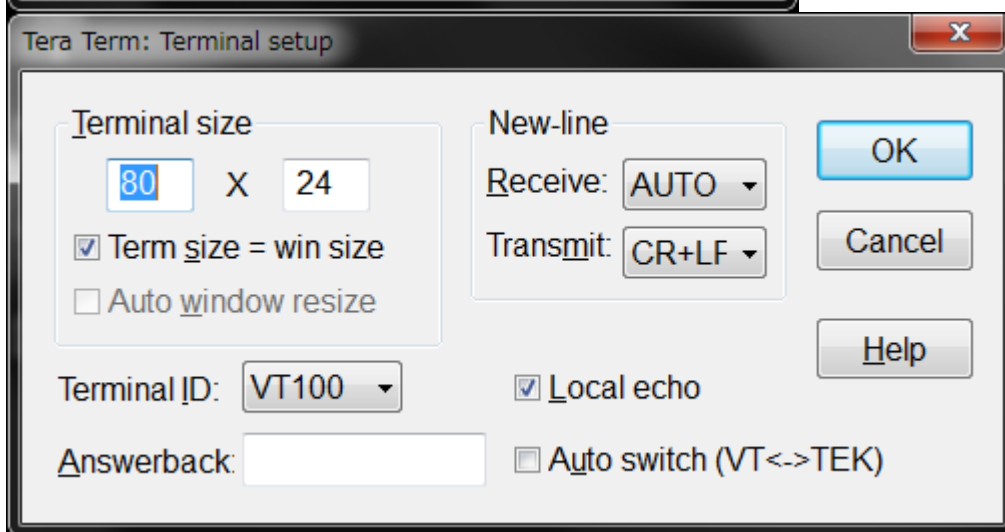
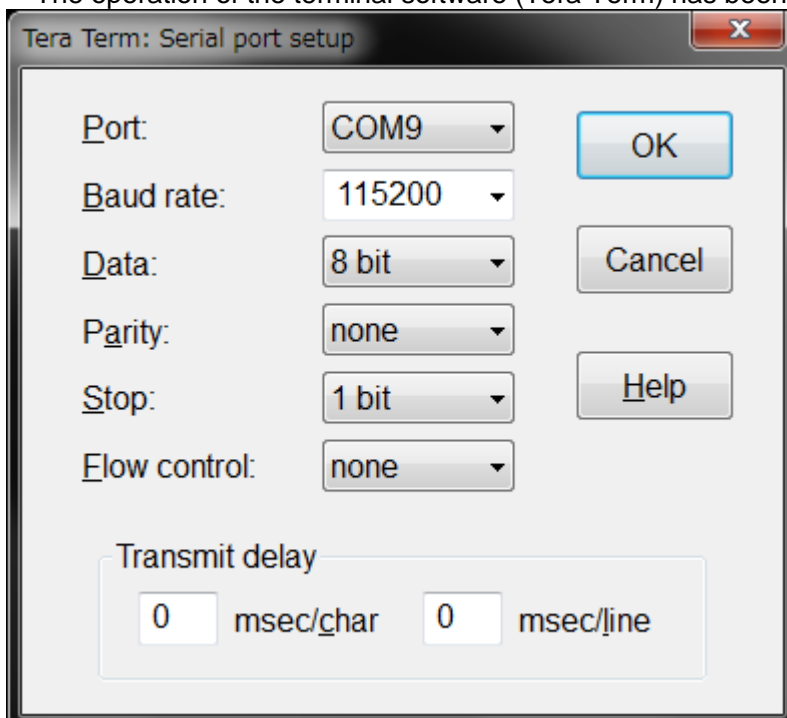

9.5. Operating Flow of Sample Program

The basic operating flows of the sample program are shown in the following.

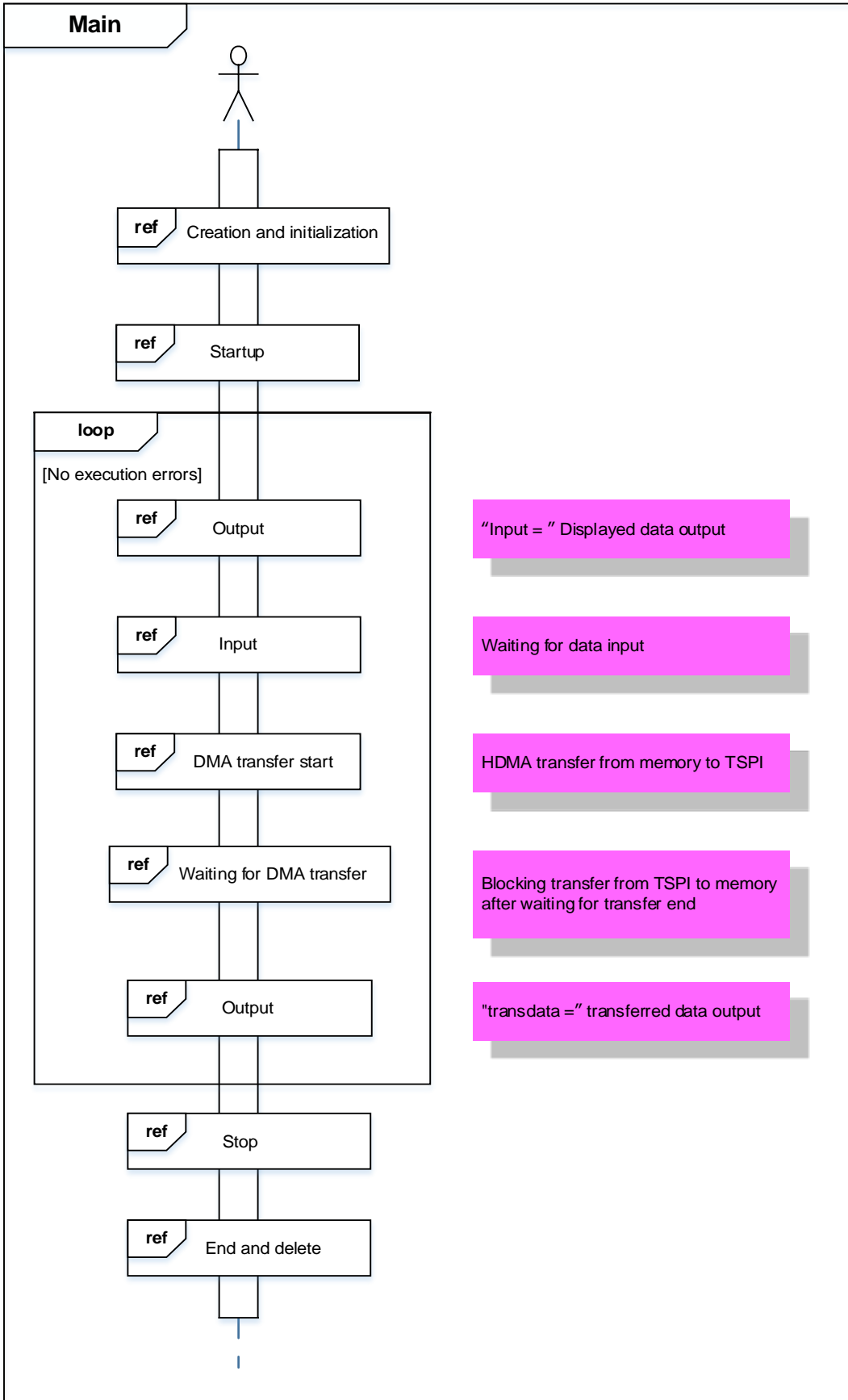

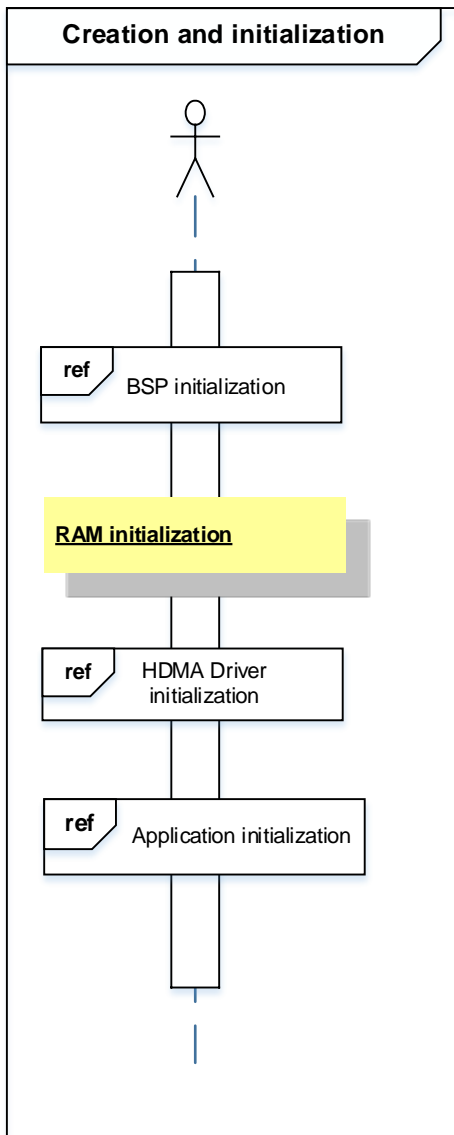

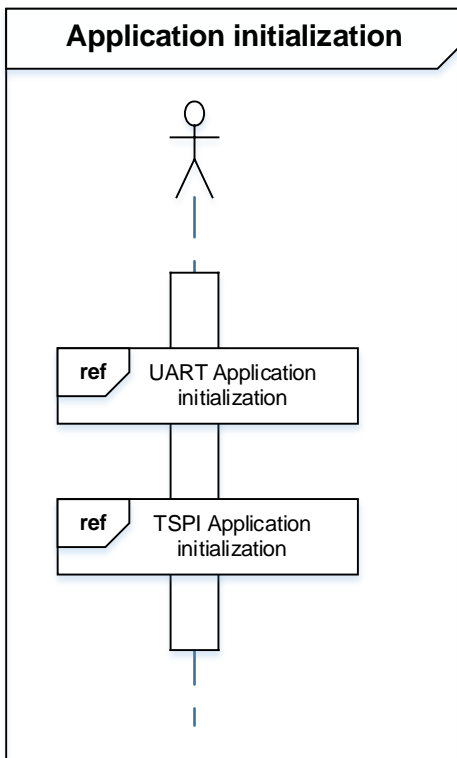
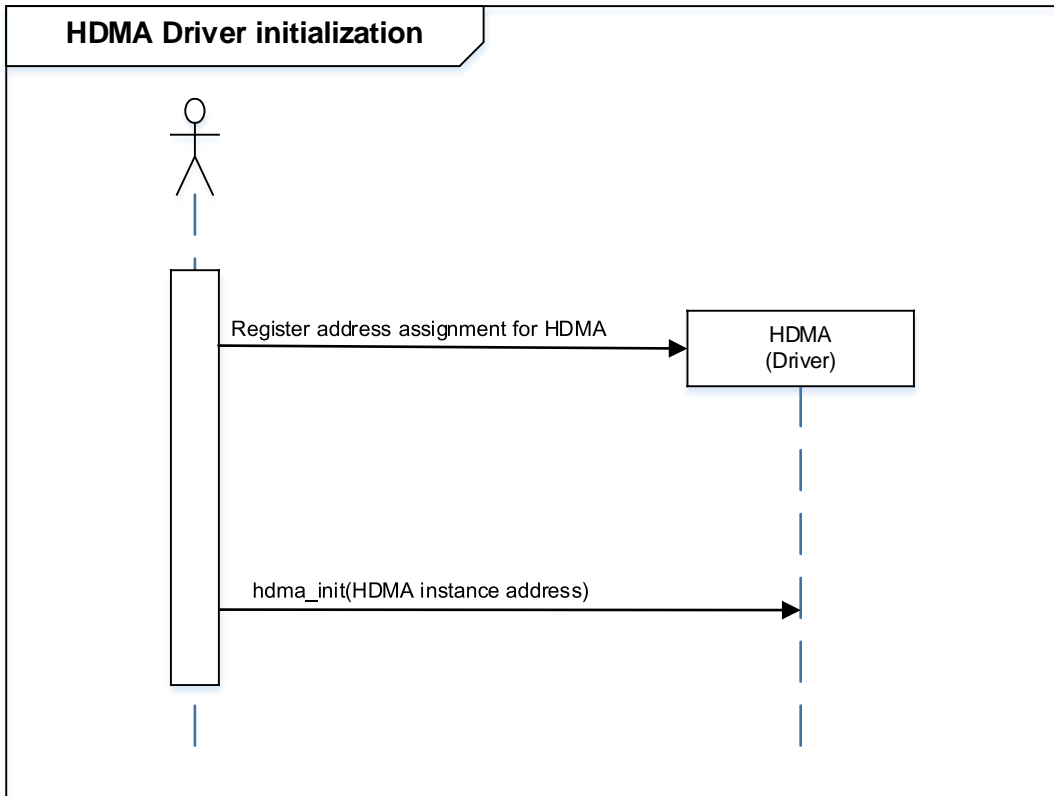

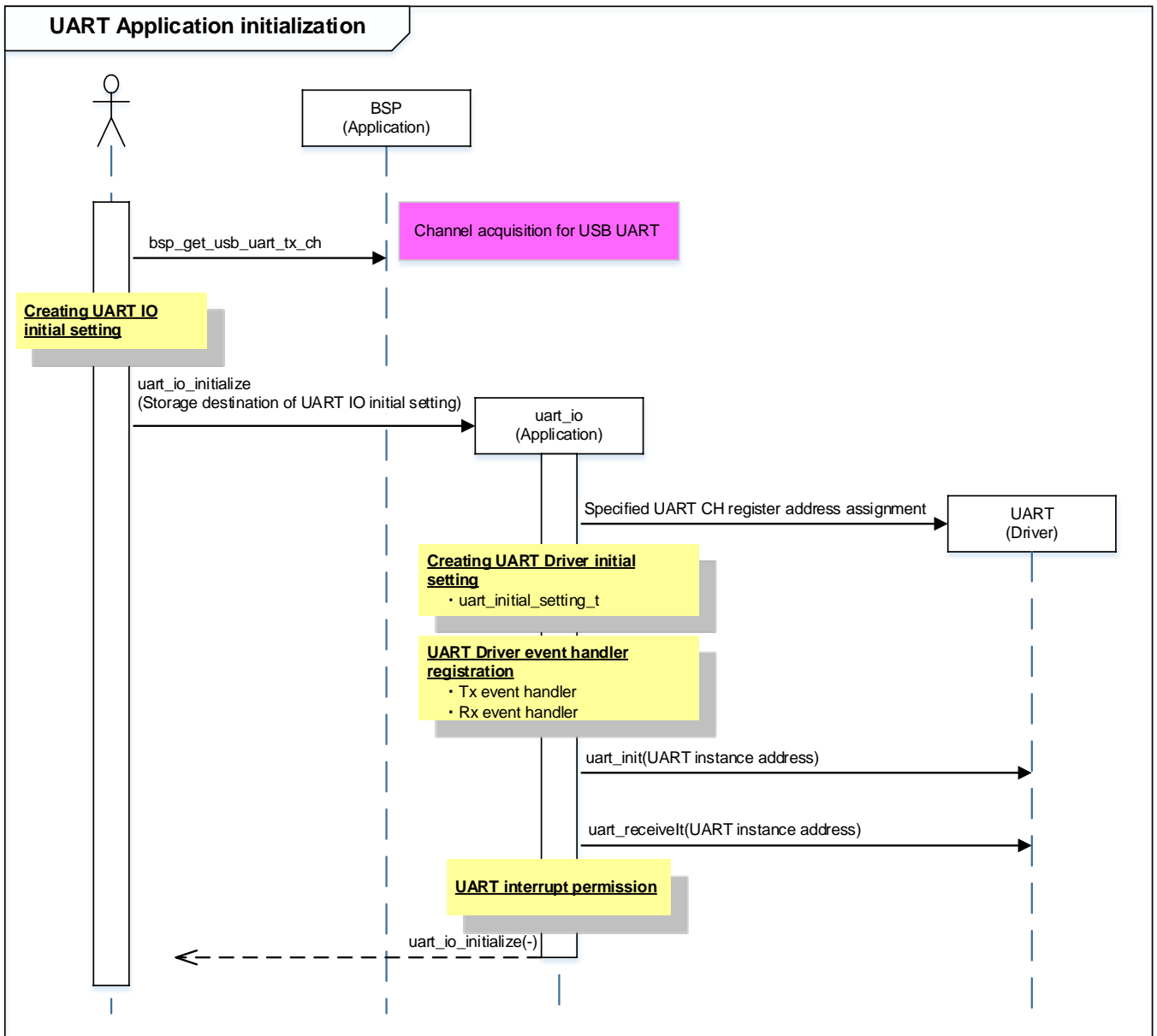

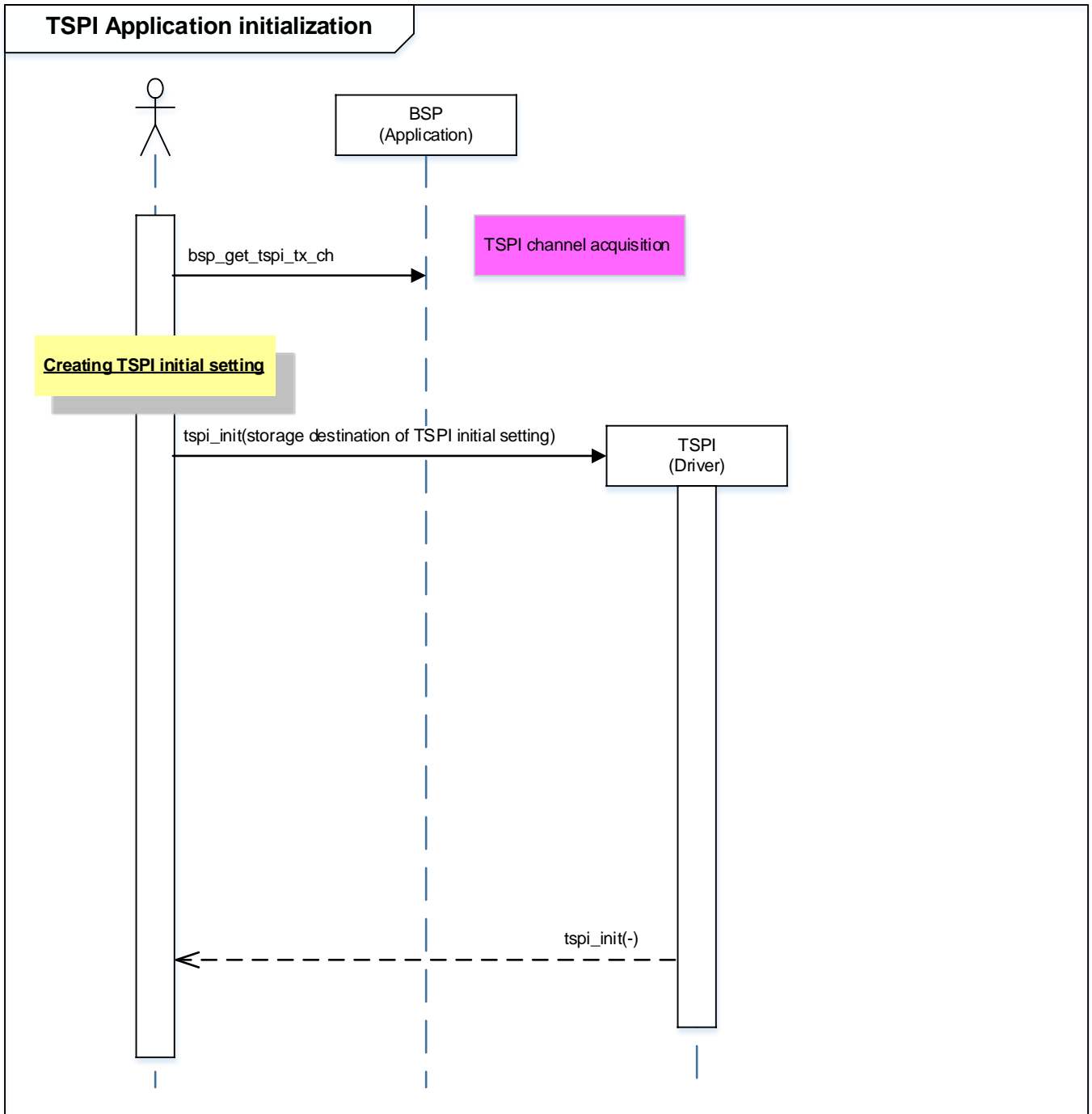

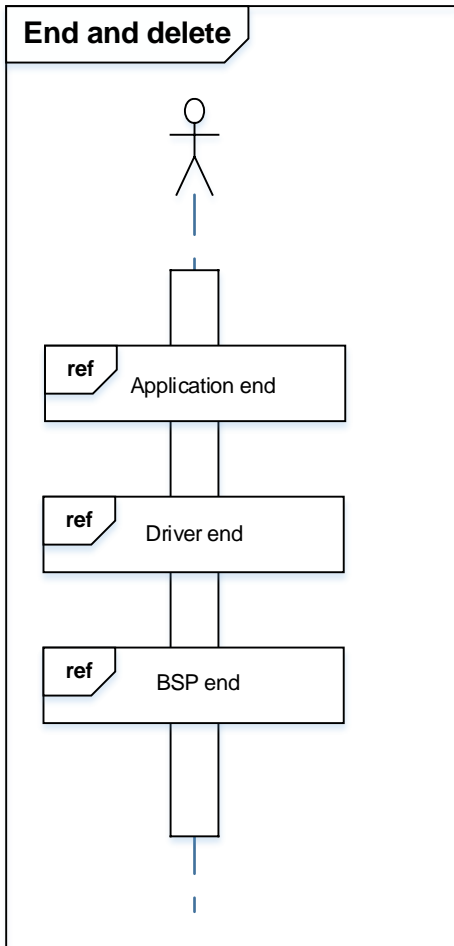

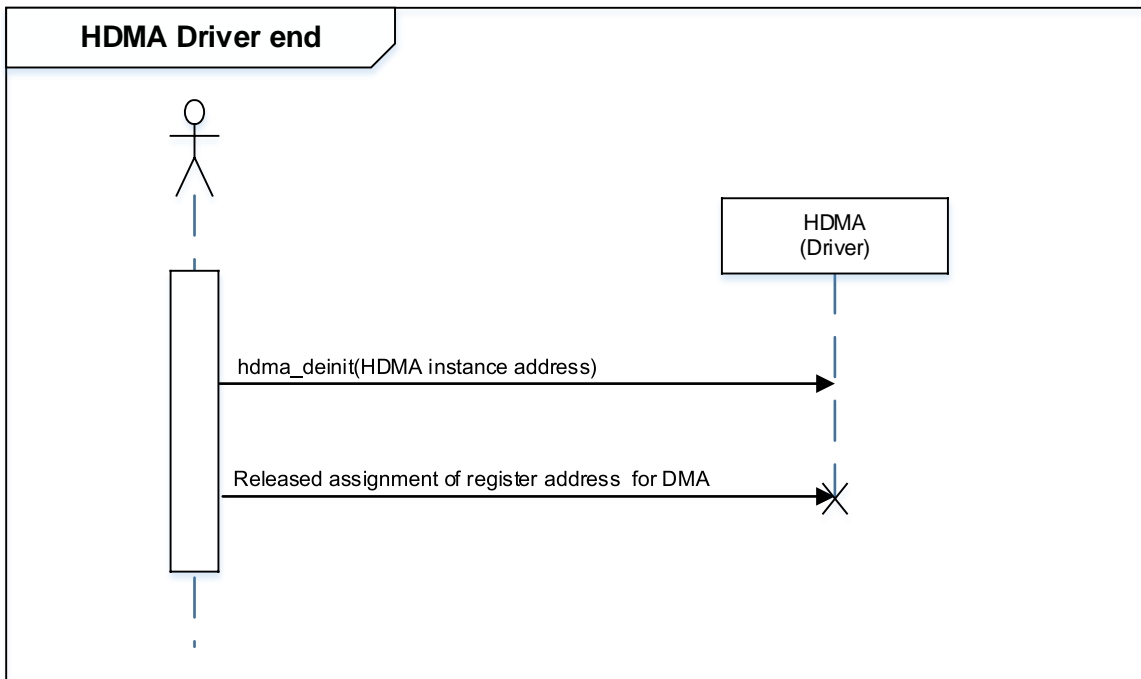
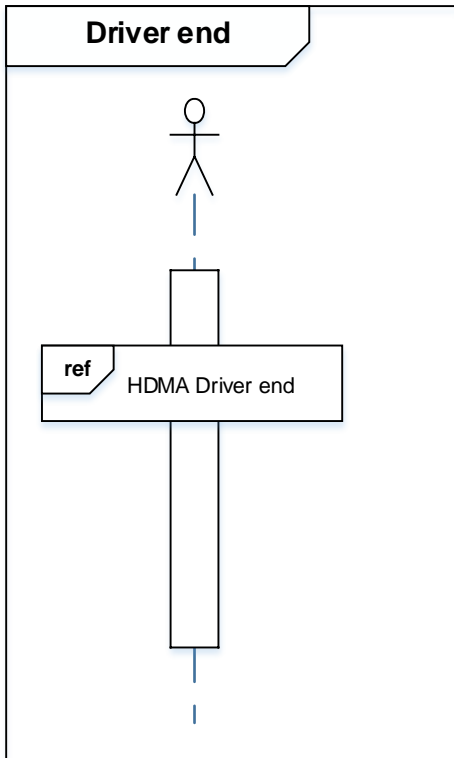

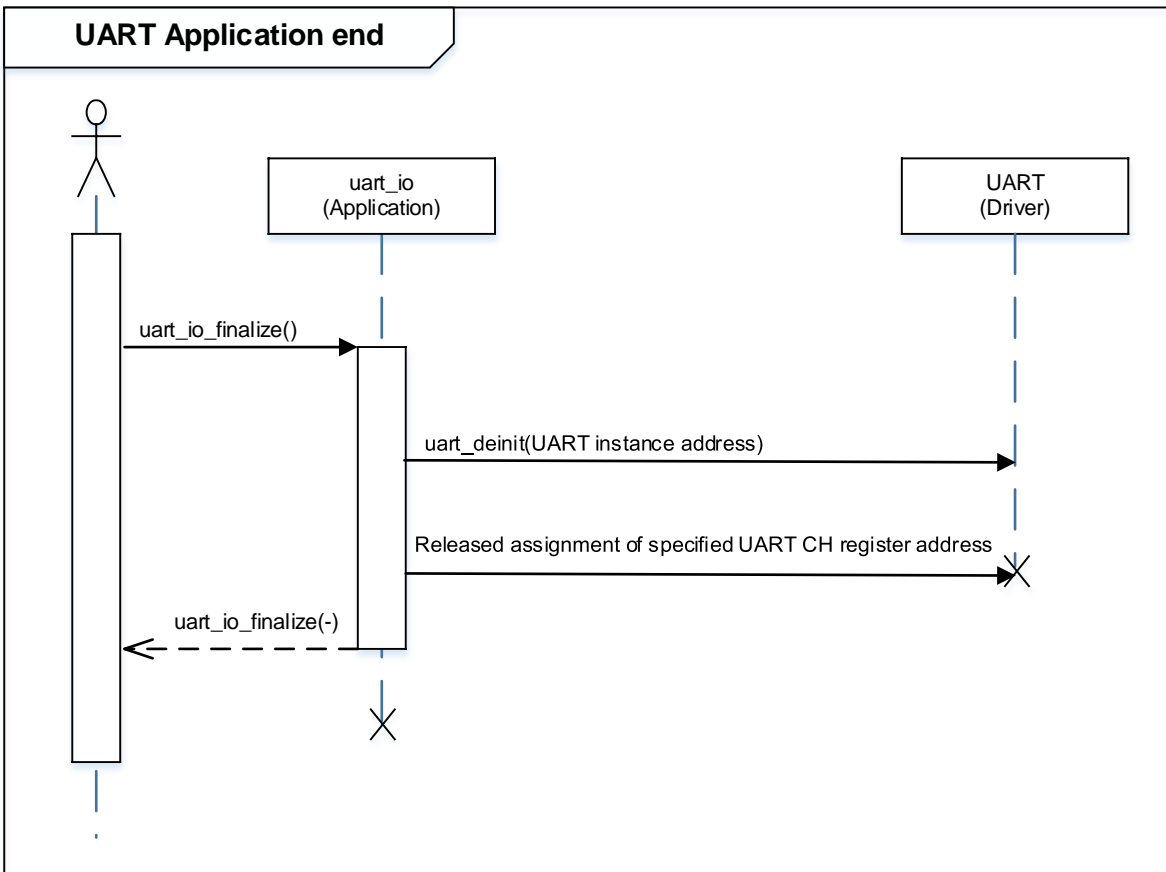
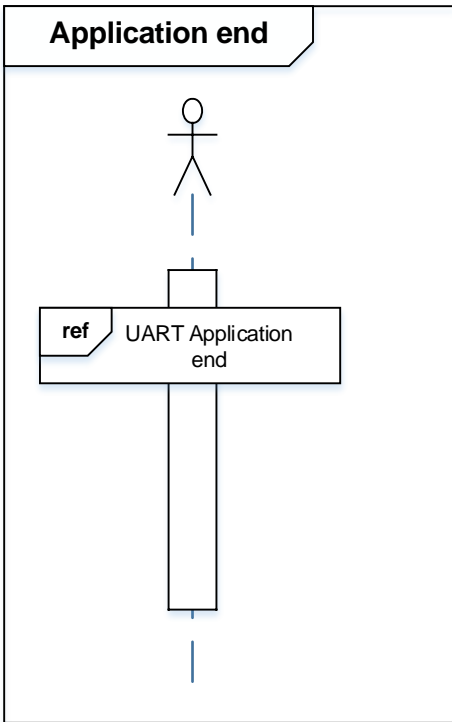

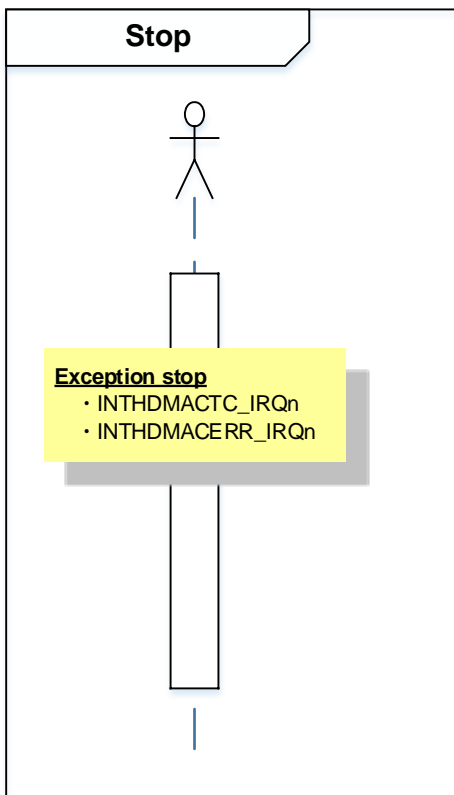
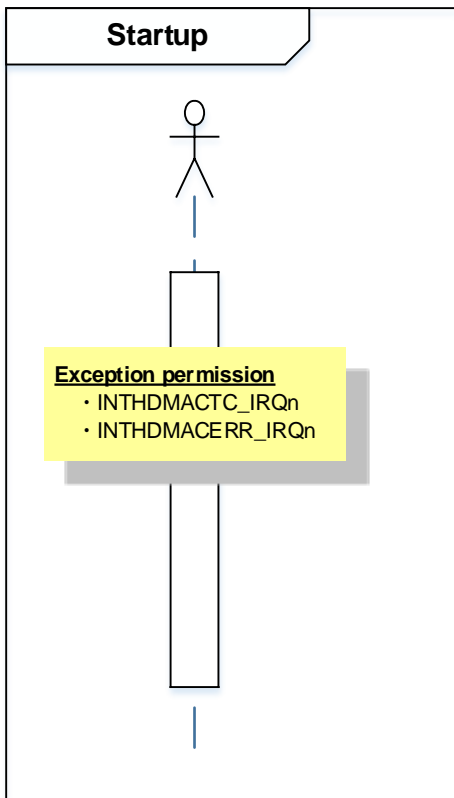

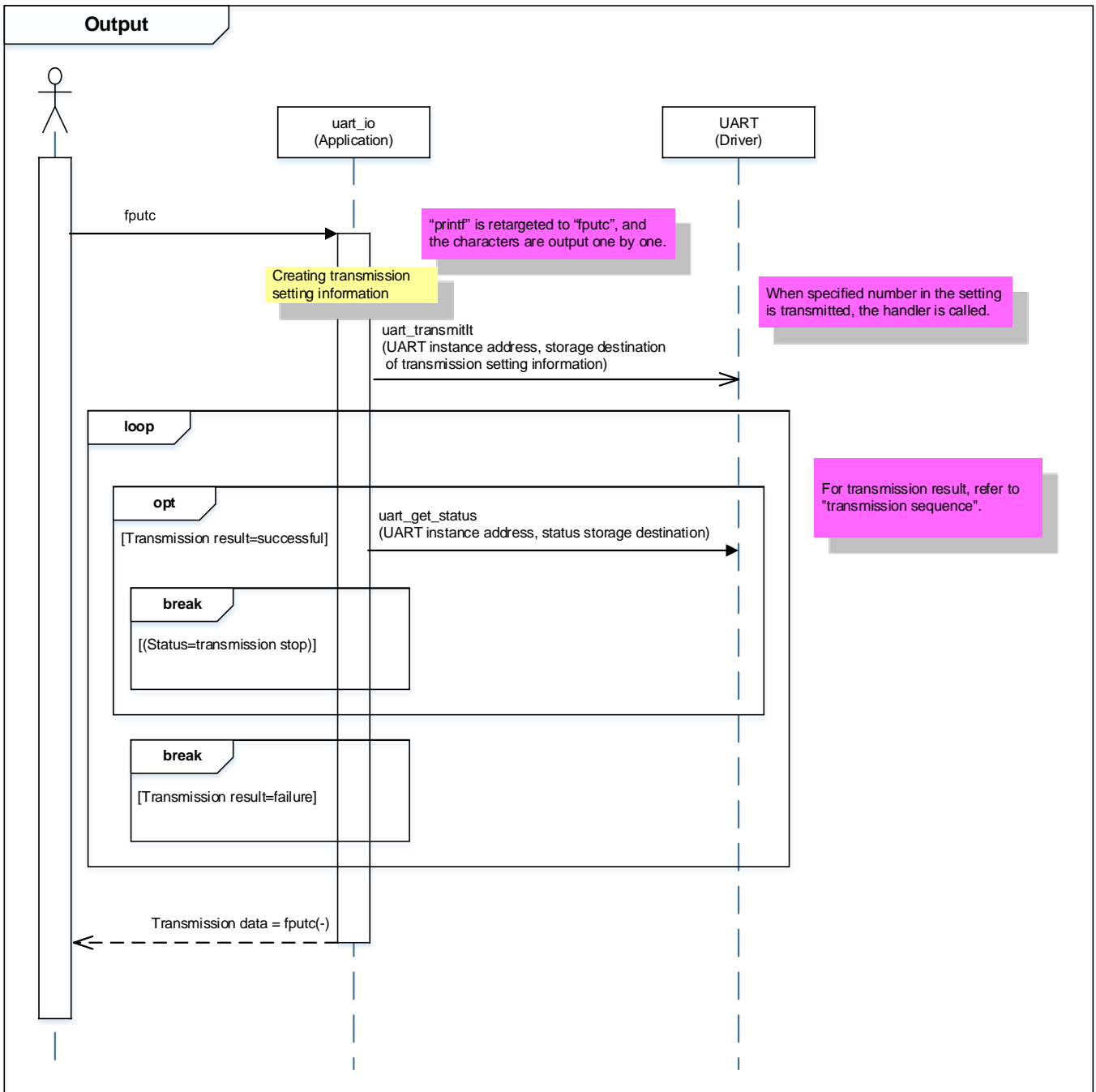

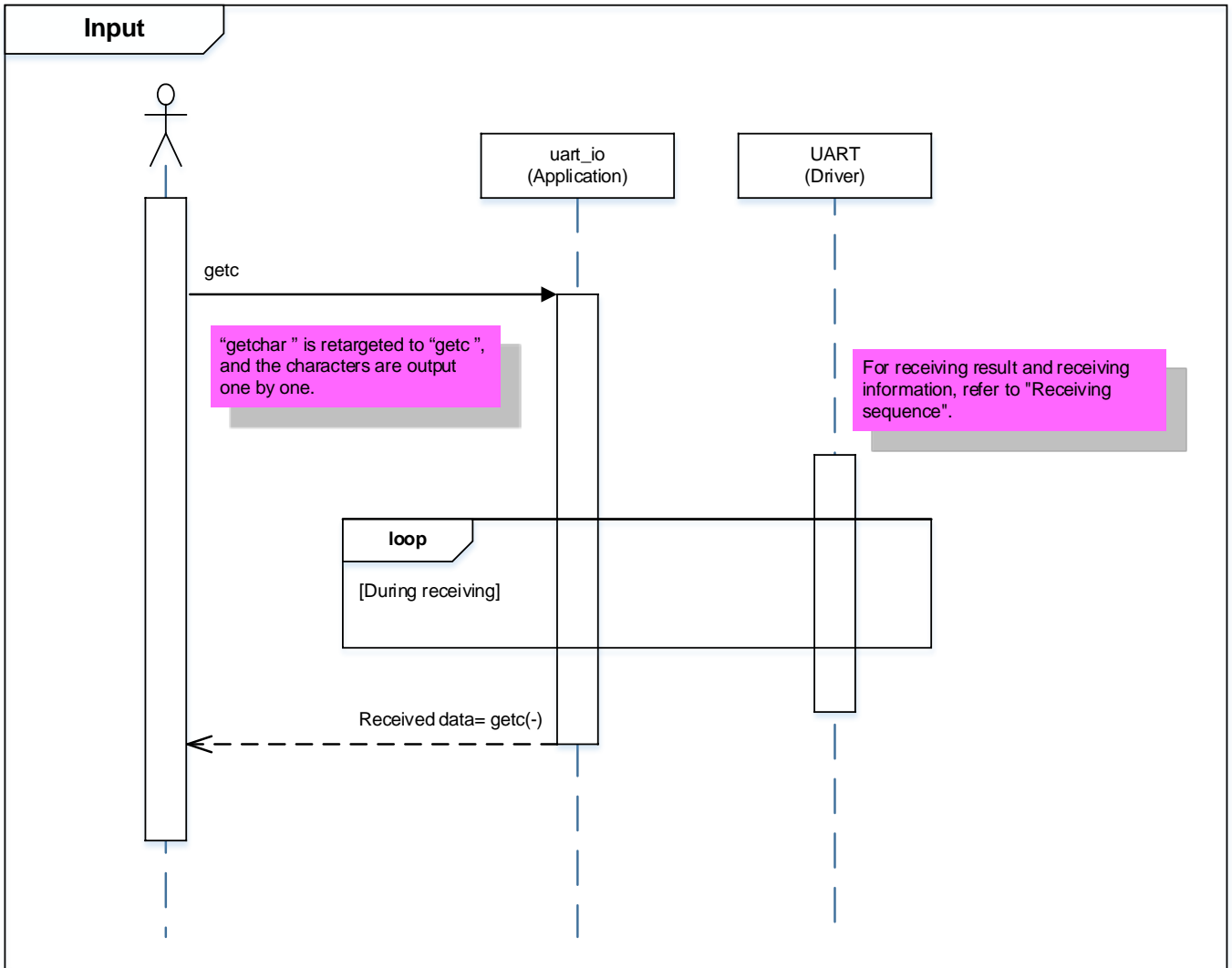

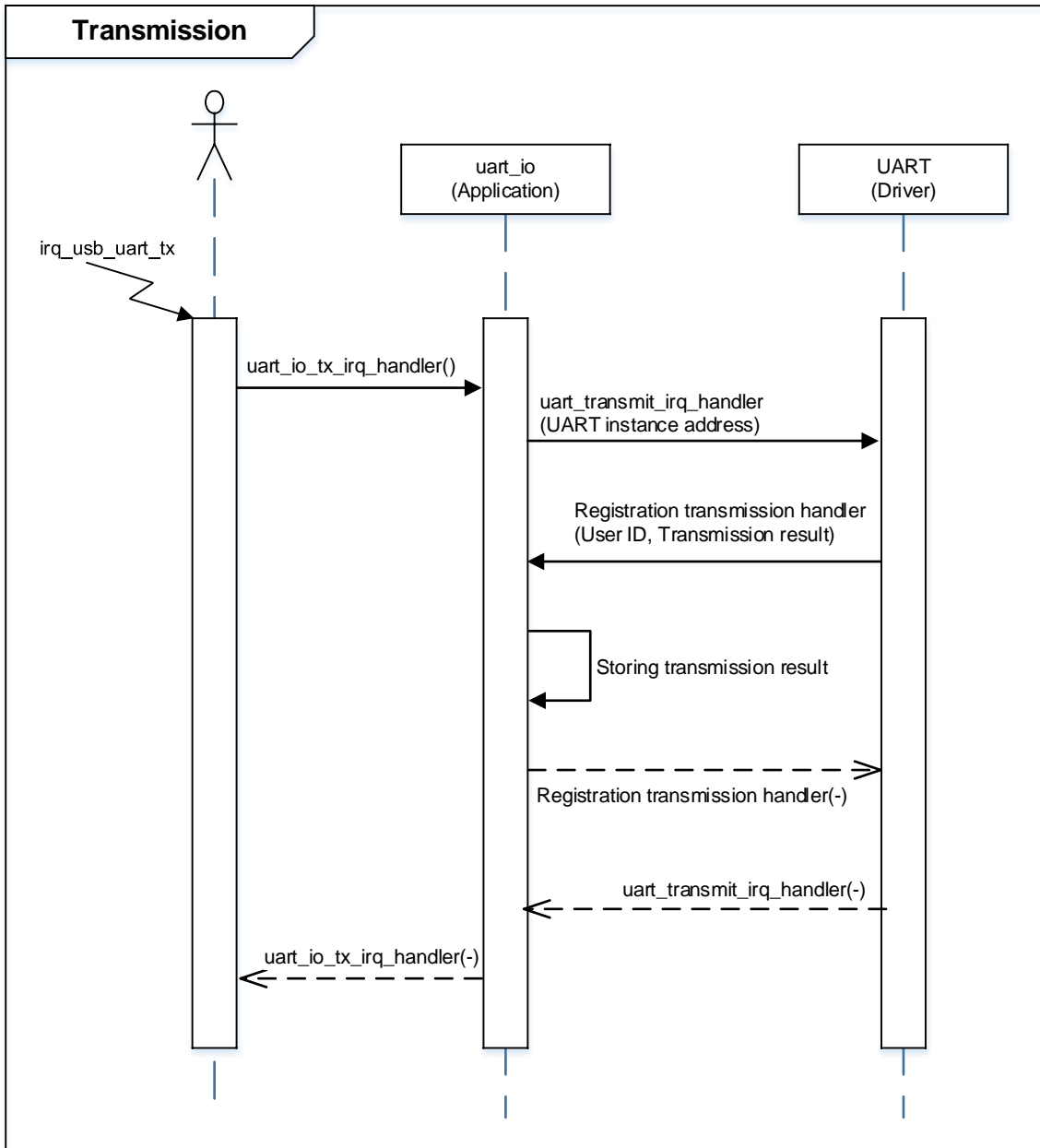

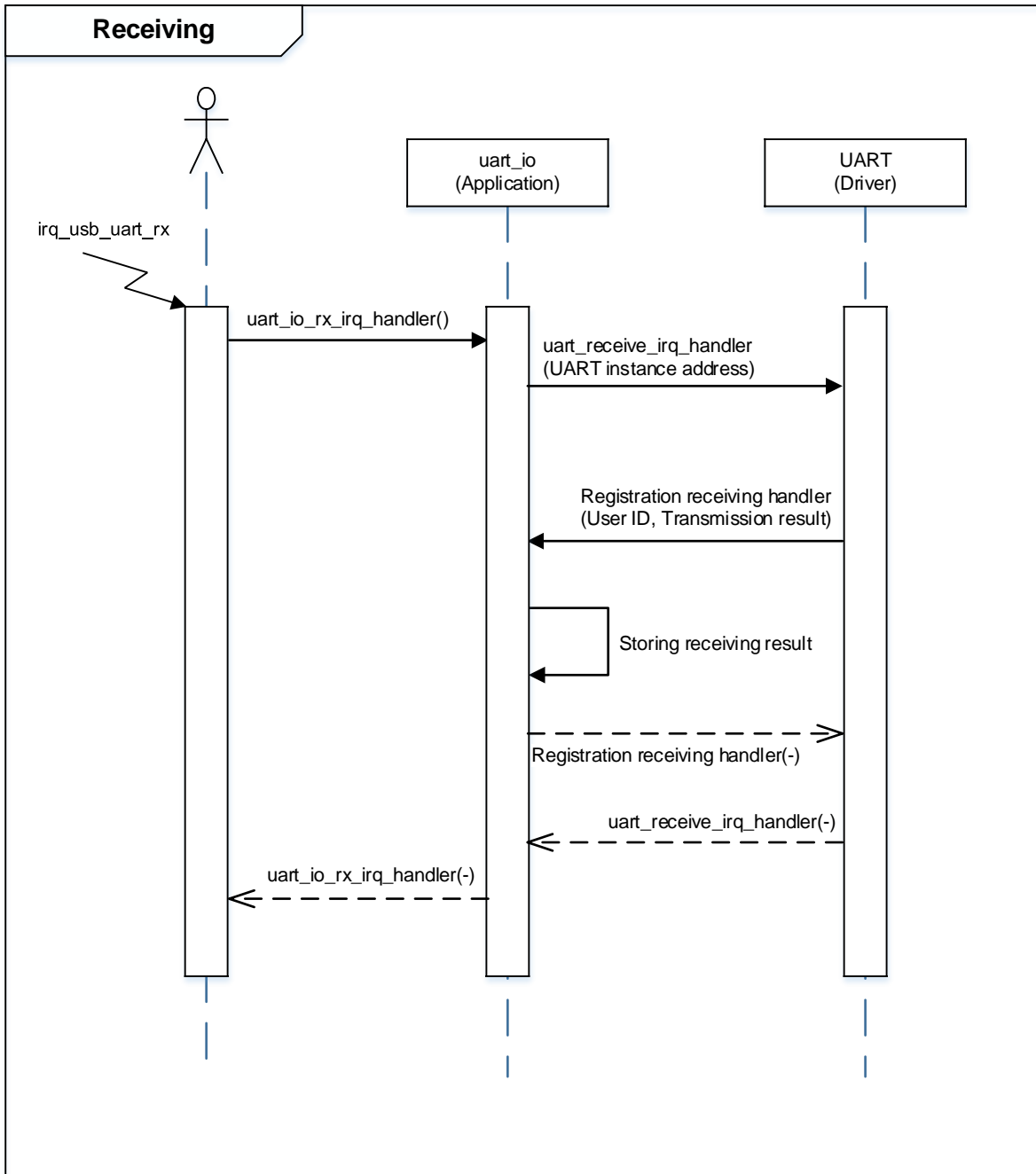

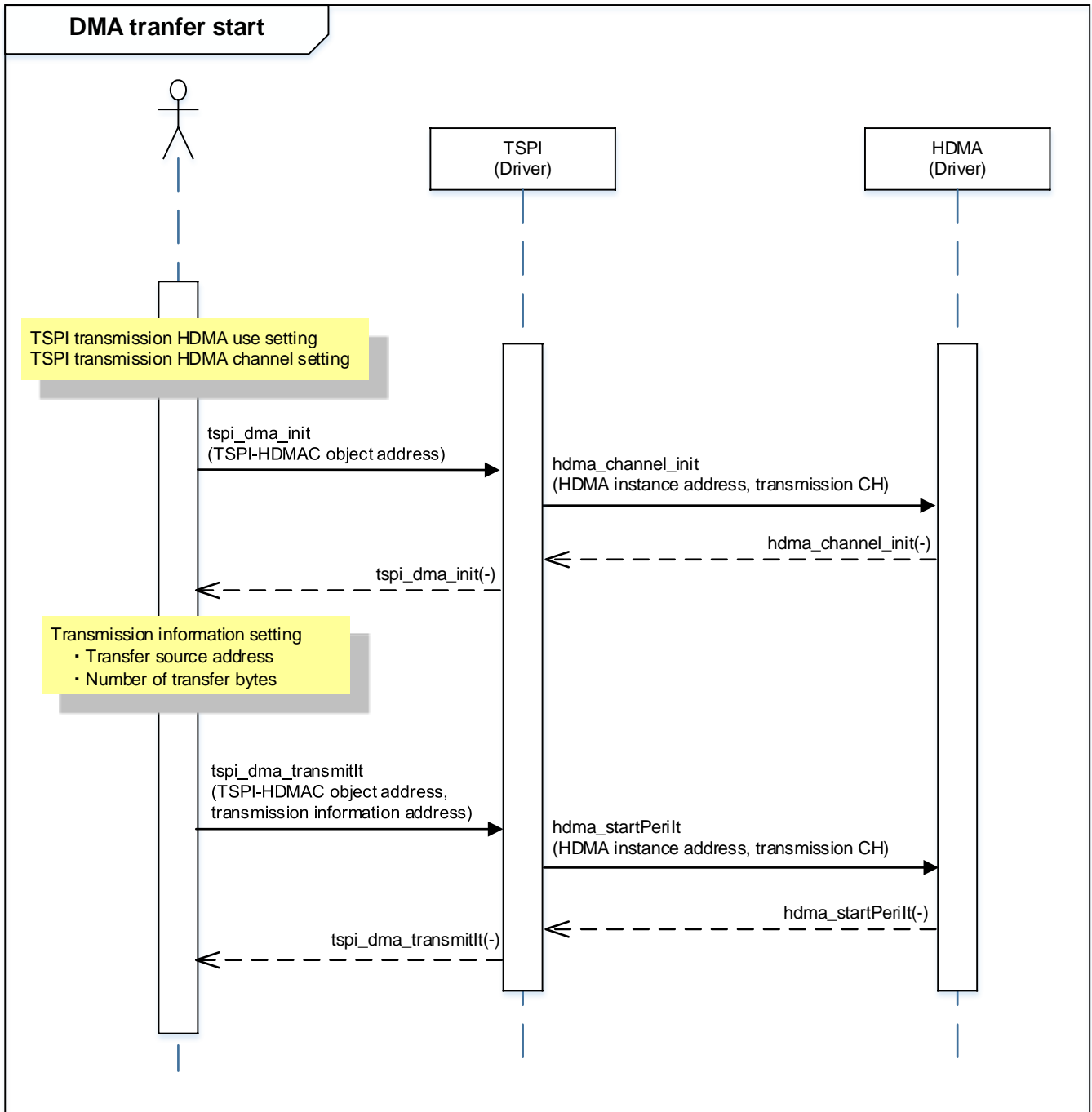

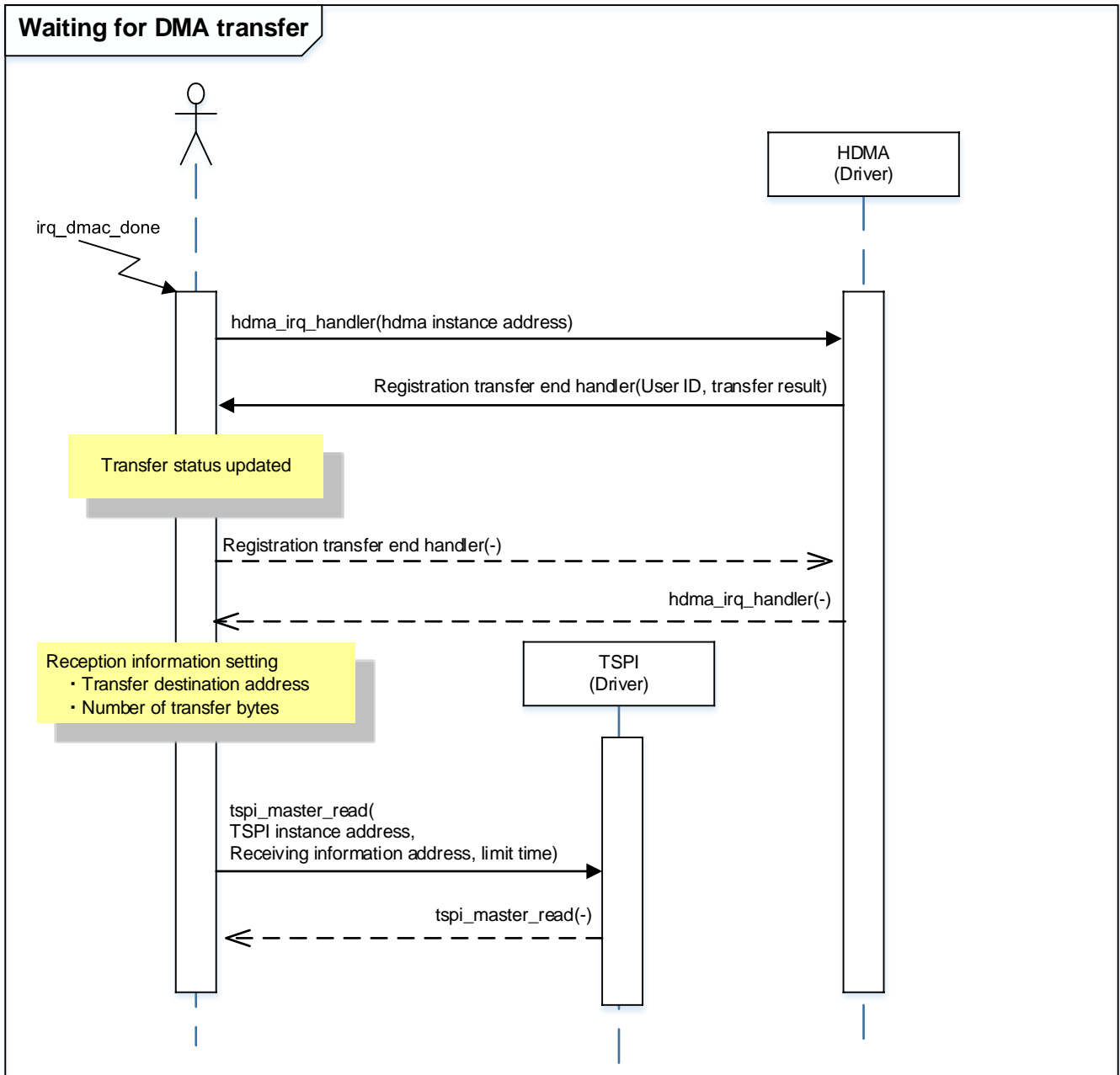

10. Precaution

When using the sample program with CPU other than TPM4G9F15, please check operation sufficiently.

11. Revision History

Rev	Date	Description
1.0	2018-11-30	First release

RESTRICTIONS ON PRODUCT USE

Toshiba Corporation and its subsidiaries and affiliates are collectively referred to as "TOSHIBA". Hardware, software and systems described in this document are collectively referred to as "Product".

- TOSHIBA reserves the right to make changes to the information in this document and related Product without notice.
- This document and any information herein may not be reproduced without prior written permission from TOSHIBA. Even with TOSHIBA's written permission, reproduction is permissible only if reproduction is without alteration/omission.
- Though TOSHIBA works continually to improve Product's quality and reliability, Product can malfunction or fail. Customers are responsible for complying with safety standards and for providing adequate designs and safeguards for their hardware, software and systems which minimize risk and avoid situations in which a malfunction or failure of Product could cause loss of human life, bodily injury or damage to property, including data loss or corruption. Before customers use the Product, create designs including the Product, or incorporate the Product into their own applications, customers must also refer to and comply with (a) the latest versions of all relevant TOSHIBA information, including without limitation, this document, the specifications, the data sheets and application notes for Product and the precautions and conditions set forth in the "TOSHIBA Semiconductor Reliability Handbook" and (b) the instructions for the application with which the Product will be used with or for. Customers are solely responsible for all aspects of their own product design or applications, including but not limited to (a) determining the appropriateness of the use of this Product in such design or applications; (b) evaluating and determining the applicability of any information contained in this document, or in charts, diagrams, programs, algorithms, sample application circuits, or any other referenced documents; and (c) validating all operating parameters for such designs and applications. **TOSHIBA ASSUMES NO LIABILITY FOR CUSTOMERS' PRODUCT DESIGN OR APPLICATIONS.**
- **PRODUCT IS NEITHER INTENDED NOR WARRANTED FOR USE IN EQUIPMENTS OR SYSTEMS THAT REQUIRE EXTRAORDINARILY HIGH LEVELS OF QUALITY AND/OR RELIABILITY, AND/OR A MALFUNCTION OR FAILURE OF WHICH MAY CAUSE LOSS OF HUMAN LIFE, BODILY INJURY, SERIOUS PROPERTY DAMAGE AND/OR SERIOUS PUBLIC IMPACT ("UNINTENDED USE").** Except for specific applications as expressly stated in this document, Unintended Use includes, without limitation, equipment used in nuclear facilities, equipment used in the aerospace industry, lifesaving and/or life supporting medical equipment, equipment used for automobiles, trains, ships and other transportation, traffic signaling equipment, equipment used to control combustions or explosions, safety devices, elevators and escalators, and devices related to power plant. **IF YOU USE PRODUCT FOR UNINTENDED USE, TOSHIBA ASSUMES NO LIABILITY FOR PRODUCT.** For details, please contact your TOSHIBA sales representative or contact us via our website.
- Product shall not be used for or incorporated into any products or systems whose manufacture, use, or sale is prohibited under any applicable laws or regulations.
- The information contained herein is presented only as guidance for Product use. No responsibility is assumed by TOSHIBA for any infringement of patents or any other intellectual property rights of third parties that may result from the use of Product. No license to any intellectual property right is granted by this document, whether express or implied, by estoppel or otherwise.
- **ABSENT A WRITTEN SIGNED AGREEMENT, EXCEPT AS PROVIDED IN THE RELEVANT TERMS AND CONDITIONS OF SALE FOR PRODUCT, AND TO THE MAXIMUM EXTENT ALLOWABLE BY LAW, TOSHIBA (1) ASSUMES NO LIABILITY WHATSOEVER, INCLUDING WITHOUT LIMITATION, INDIRECT, CONSEQUENTIAL, SPECIAL, OR INCIDENTAL DAMAGES OR LOSS, INCLUDING WITHOUT LIMITATION, LOSS OF PROFITS, LOSS OF OPPORTUNITIES, BUSINESS INTERRUPTION AND LOSS OF DATA, AND (2) DISCLAIMS ANY AND ALL EXPRESS OR IMPLIED WARRANTIES AND CONDITIONS RELATED TO SALE, USE OF PRODUCT, OR INFORMATION, INCLUDING WARRANTIES OR CONDITIONS OF MERCHANTABILITY, FITNESS FOR A PARTICULAR PURPOSE, ACCURACY OF INFORMATION, OR NONINFRINGEMENT.**
- Do not use or otherwise make available Product or related software or technology for any military purposes, including without limitation, for the design, development, use, stockpiling or manufacturing of nuclear, chemical, or biological weapons or missile technology products (mass destruction weapons). Product and related software and technology may be controlled under the applicable export laws and regulations including, without limitation, the Japanese Foreign Exchange and Foreign Trade Law and the U.S. Export Administration Regulations. Export and re-export of Product or related software or technology are strictly prohibited except in compliance with all applicable export laws and regulations.
- Please contact your TOSHIBA sales representative for details as to environmental matters such as the RoHS compatibility of Product. Please use Product in compliance with all applicable laws and regulations that regulate the inclusion or use of controlled substances, including without limitation, the EU RoHS Directive. **TOSHIBA ASSUMES NO LIABILITY FOR DAMAGES OR LOSSES OCCURRING AS A RESULT OF NONCOMPLIANCE WITH APPLICABLE LAWS AND REGULATIONS.**