

**M4G group (1)**  
**Application Note**  
**Real Time Clock**  
**(RTC-A)**

**Outlines**

This application note is a reference material for developing products using the real time clock (RTC) function of M4G group (1).

This document helps the user check operation of the product and develop its program.

Target sample program: RTC\_UART\_LED

---

**Table of Contents**

Outlines.....	1
Table of Contents.....	2
1. Preface .....	3
2. Reference Document .....	4
3. Function to Use.....	4
4. Target Device.....	4
5. Operation confirmation condition.....	5
6. Evaluation Board Setting.....	6
7. Operation of Evaluation Board .....	6
8. Outline of RTC Function.....	7
9. Sample Program .....	8
9.1. Initialization .....	8
9.2. Sample Program Main Operation.....	8
9.3. Setting Modification of Displayed Time Information .....	8
9.4. Output Example of Sample Program.....	9
9.4.1. Setting Example of Terminal Software.....	9
9.5. Operating Flow of Sample Program .....	10
10. Precaution.....	20
11. Revision History .....	20
RESTRICTIONS ON PRODUCT USE .....	21

## 1. Preface

This sample program is for checking the operation of RTC clock function  
 The date and time will be displayed on the terminal software on the host PC via USB-UART.

### Structure diagram of Sample program

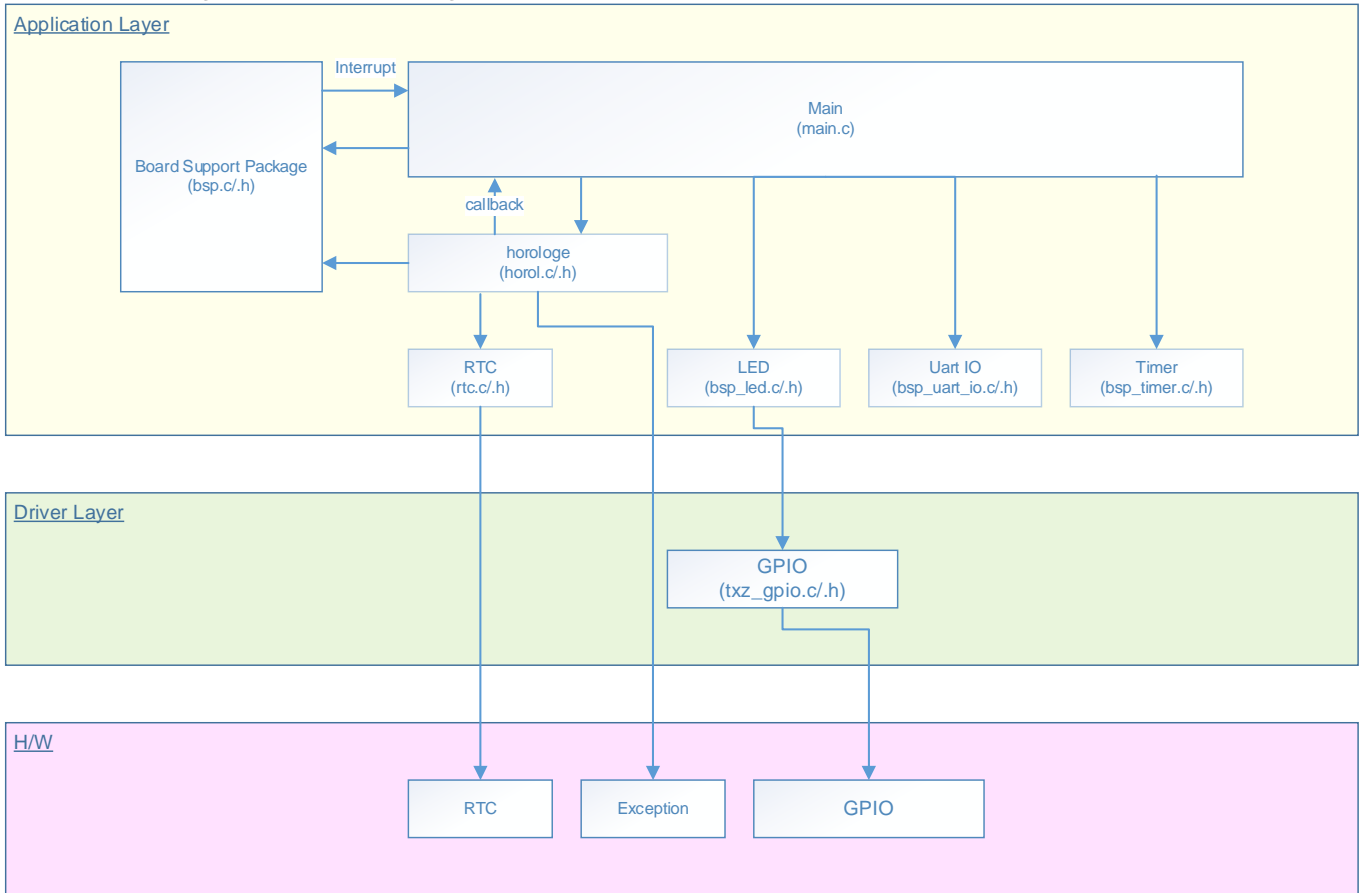

### 2. Reference Document

- Datasheet  
TMPM4G Group (1) datasheet Rev1.0 (Japanese edition)
- Reference manual  
Real Time Clock (RTC-A) Rev2.1 (Japanese edition)  
Asynchronous Serial Communication Circuit (UART-C) Rev3.0 (Japanese edition)  
Input and Output Ports (PORT-M4G(1)) Rev.1.0( Japanese edition)
- Application note  
M4G Group (1) Application Note Startup (CMSIS System &Clock Configuration) Rev1.0
- Other reference document  
TMPM4G (1) Group Peripheral Driver User Manual (Doxygen)

### 3. Function to Use

IP	Channel	Port	Function/Operation mode
Real Time Clock	-	-	Clock function
Asynchronous Serial Communication Circuit	ch0	PE2 (UT0RXD) PE3 (UT0TXDA)	UART mode
Input and Output Ports	-	PE4 (Output Port)	Output

### 4. Target Device

The target devices of this application note are as follows;

TMPM4G9F15FG	TMPM4G9F10FG	TMPM4G9FEFG	TMPM4G9FDFG
TMPM4G9F15XBG	TMPM4G9F10XBG	TMPM4G9FEXBG	TMPM4G9FDXBG
TMPM4G8F15FG	TMPM4G8F10FG	TMPM4G8FEFG	TMPM4G8FDFG
TMPM4G8F15XBG	TMPM4G8F10XBG	TMPM4G8FEXBG	TMPM4G8FDXBG
	TMPM4G7F10FG	TMPM4G7FEFG	TMPM4G7FDFG
	TMPM4G6F10FG	TMPM4G6FEFG	TMPM4G6FDFG

\*This sample program operates on the evaluation board of TMPM4G9F15FG.

If other function than the TMPM4G9F15 one is checked, it is necessary that CMSIS Core related files (C startup file and I/O header file) should be changed properly.

The BSP related file is dedicated to the evaluation board (TMPM4G9F15). If other function than the TMPM4G9F15 one is checked, the BSP related file should be changed properly.

## 5. Operation confirmation condition

Used microcontroller	TMPM4G9F15FG
Used board	TMPM4G9F15FG Evaluation Board by Sensystr
Unified development environment	IAR Embedded Workbench for ARM 8.11.2.13606
Unified development environment	µVision MDK Version 5.24.2.0
Terminal software	TeraTerm V4.96
Sample program	V1000

Evaluation board (TMPM4G9F15FG Evaluation Board) Top view

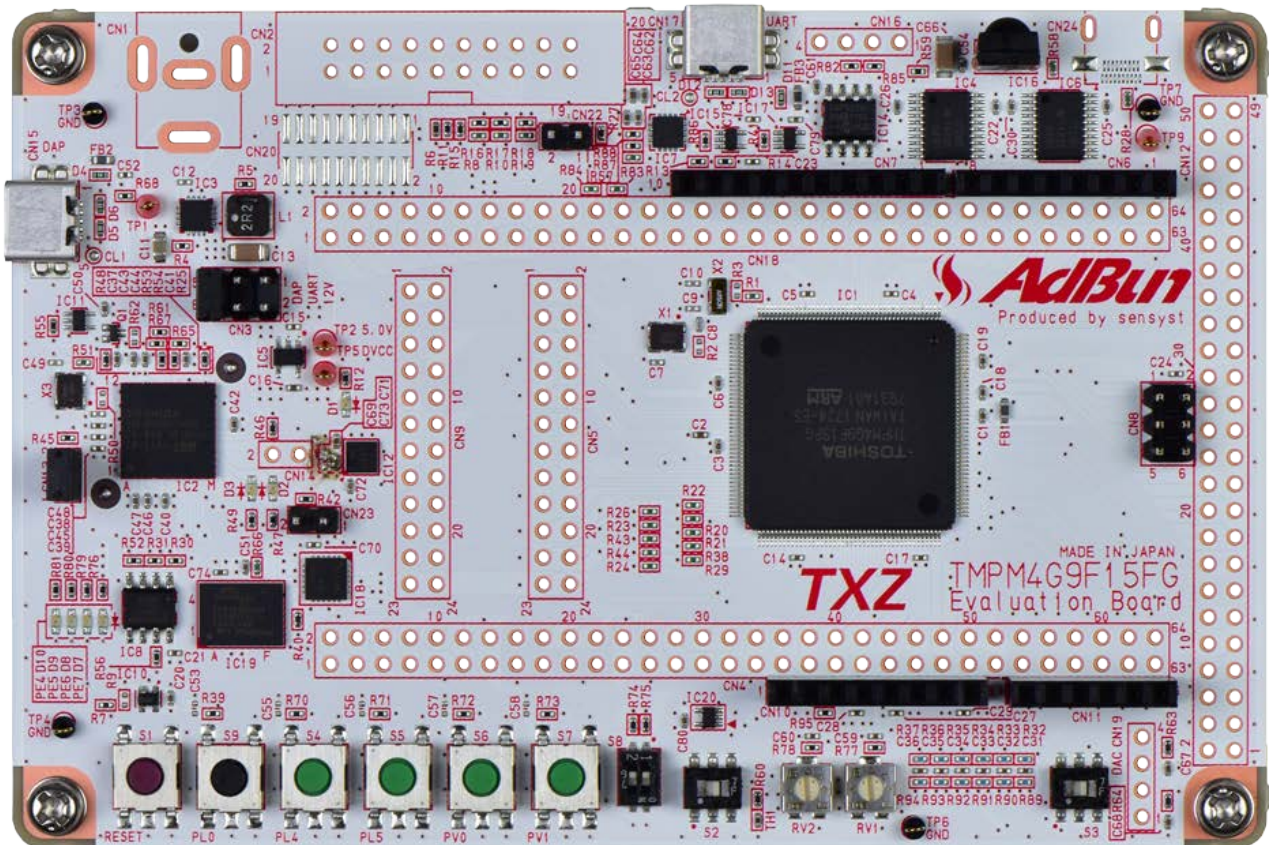

## 6. Evaluation Board Setting

The following pin connections should be done on the evaluation board.

CN5		
Board function	Through-hole No.	Through-hole No.
USB UART conversion	1: USB_UT_RX	2: PE2
USB UART conversion	3: USB_UT_TX	4: PE3

CN9		
Board function	Through-hole No.	Through-hole No.
LED (D10)	1: LED0	2: PE4

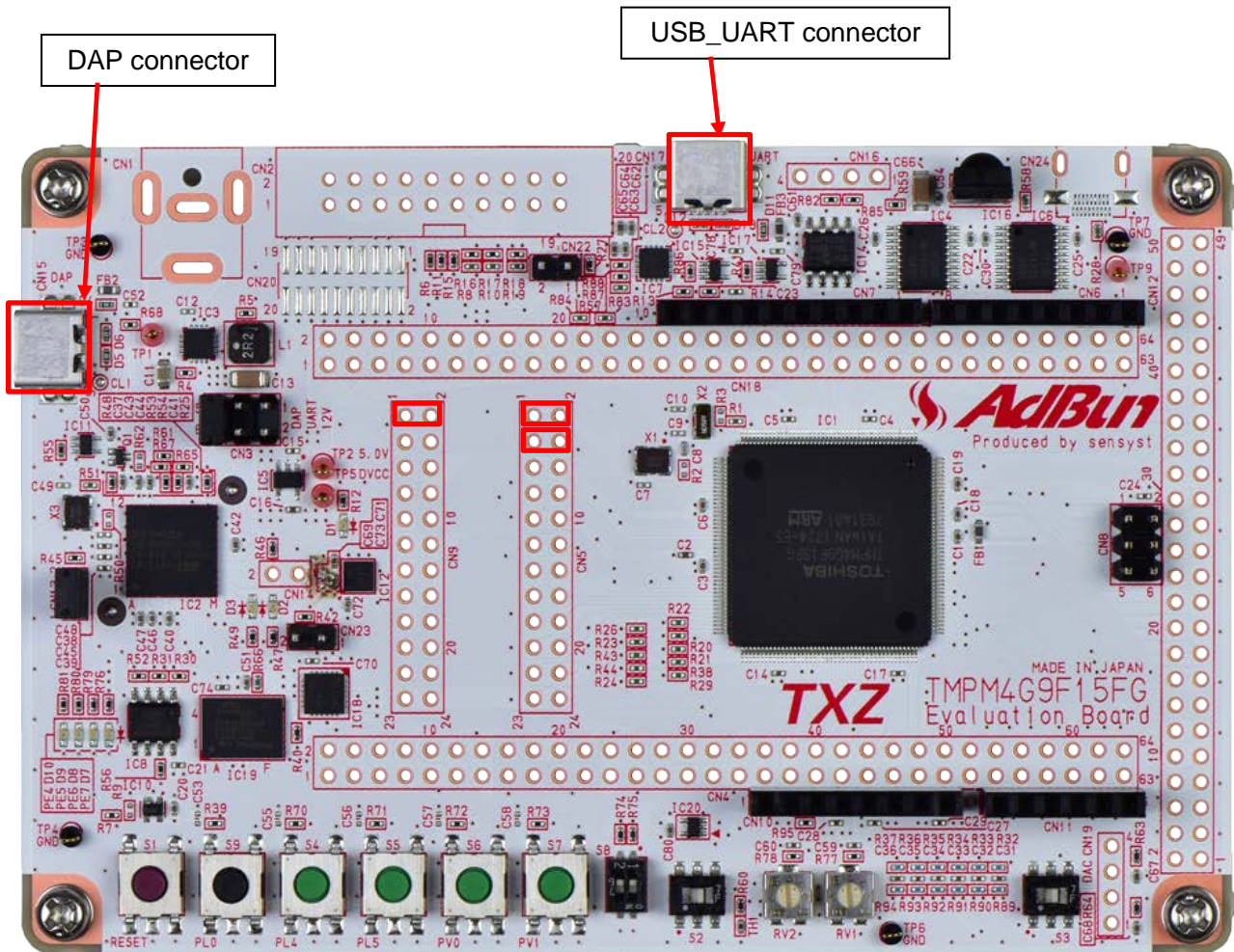

## 7. Operation of Evaluation Board

PC and the USB\_UART are connected for communication with the terminal software. After the start of RTC, date and time are displayed in terminal software. The sample program starts from 2017-01-01 00:00:00.

## 8. Outline of RTC Function

The real time clock (RTC) is a clock function to which even the calendar corresponding to a leap year can respond. At counting a low speed clock (fs), a 1Hz clock is generated and it operates. Clock correction function can adjust clock progress and delay due to low speed oscillator error. The alarm function can output a pulse from ALARM\_N pin or output an interrupt request by detecting coincidence of the time and the clock which was set up beforehand.

Since the RTC operates with a low speed clock, it can operate during Low Power Consumption modes, such as IDLE, STOP1, and STOP2. Moreover, it can be made to return from a Low Power Consumption mode using the interrupt request of RTC.

**Functional outline**

Function classification	Function	A Functional Description or the range
Clock function	Clock source	Low speed clock (32.768 kHz)
	Clock	Respond to hour, minute and second. Selectable 12(am/ pm) and 24 hour display.
	Calendar	Respond to date, a day of the week, month, year and leap year.
Alarm function	Alarm	It can set up minute, hour, a day of the week, and a day.
	Interruption	An INTRTC interrupt request is output when the clock matches the date and time of the alarm register.
	Pulse output	Pulse is output from the ALARM_N terminal when the clock matches the date and time of the alarm register. (Note)
Periodic interruption function	Interruption	An INTRTC interrupt request is outputted to the frequency of 1Hz, 2Hz, 4Hz, 8Hz and 16Hz.
	Pulse output	The pulse is outputted to frequency 1Hz, 2Hz, 4Hz, 8Hz and 16Hz. from an ALARM_N pin. (Note)
Other functions	Clock correction	Correction-reference time: Select from 1, 10, 20, 30 seconds or 1 minute. Correction value: +255 to -256
	Protection of a clock correction functional register	A correction functional control register <b>[RTCADJCTL]</b> , a correction value register <b>[RTCADJDAT]</b> , and the correction value sign register <b>[RTCADJSIGN]</b> can be protected from writing by a protection register <b>[RTCPROTECT]</b> .
	1Hz clock output	1Hz clock (duty 50%) is output from the RTCOUT pin.(Note)
	Reset register	A second counter and an alarm register are initialized.

Note: There are built-in products and a non-built-in product with a RTCOUT pin and an ALARM\_N pin. Please refer to the reference manual "Product Information" for details.

## 9. Sample Program

The sample program displays year / month / date and time in terminal software.  
 The sample program uses 2 Hz interrupt and clock function.  
 Time information is displayed on the terminal software via USB-UART.  
 The LED blinks at the same timing of the display timing of the terminal software.

### 9.1. Initialization

The following initialization is done after power is supplied.  
 The initialization of each clock setting and the setting of the watchdog timer are done.

### 9.2. Sample Program Main Operation–

After initialization, the following operations are done in the “main” function.

- (1) BSP (Board Support Package) initialization
- (2) Driver initialization
- (3) Application initialization

After the settings are done, the RTC starts.

Initial value: 2017-01-01, 00:00:00

The display to the terminal software is done by the 2-Hz interrupt of the RTC.

The display to the terminal software is done every even count of the interrupt. So the display value is updated every 1 second.

The LED (D10) repeats lighting and lights-off every 500ms (500-ms lighting and 500-ms lights-off) using the 2-Hz interrupt.

### 9.3. Setting Modification of Displayed Time Information

When the time information is changed, the setting values in RTC: main.c should be modified.

Item	Modified location	Note
CFG_HOROL_HOUR_NOTATION	(RTC_HOUR_NOTATION_24)	24-hour display setting
CFG_HOROL_CENTURY	((uint8_t)21)	Year setting
CFG_HOROL_YEAR	((uint8_t)17)	Setting of 2 least significant digits of the year
CFG_HOROL_MONTH	(RTC_MONTH_JAN)	Month setting
CFG_HOROL_DATE	((uint8_t)1)	Date setting
CFG_HOROL_DAY	(RTC_DAY_SUNDAY)	Day setting
CFG_HOROL_MERIDIEM	(RTC_MERIDIEM_AM)	AM/PM setting
CFG_HOROL_HOUR	((uint8_t)0)	Hour setting
CFG_HOROL_MIN	((uint8_t)0)	Minute setting
CFG_HOROL_SEC	((uint8_t)0)	Second setting

The initial values of the time has been set to 2017-01-01 00:00:00 in this sample program.  
 Any time values can be set by modifying each item value.

For the modification conditions and the range of each item value, refer to “bsp\_rtc.h” file.  
 The modification range of each item is set.



**9.4. Output Example of Sample Program**

When this sample program operates, the content in the clock register is displayed, as shown in the following figure.

The followings are the sample values of the output of the default setting state.

```
2017-01-01 00:00:00
2017-01-01 00:00:01
2017-01-01 00:00:02
2017-01-01 00:00:03
2017-01-01 00:00:04
2017-01-01 00:00:05
```

**9.4.1. Setting Example of Terminal Software**

The operation of the terminal software (Tera Term) has been checked with the following settings.

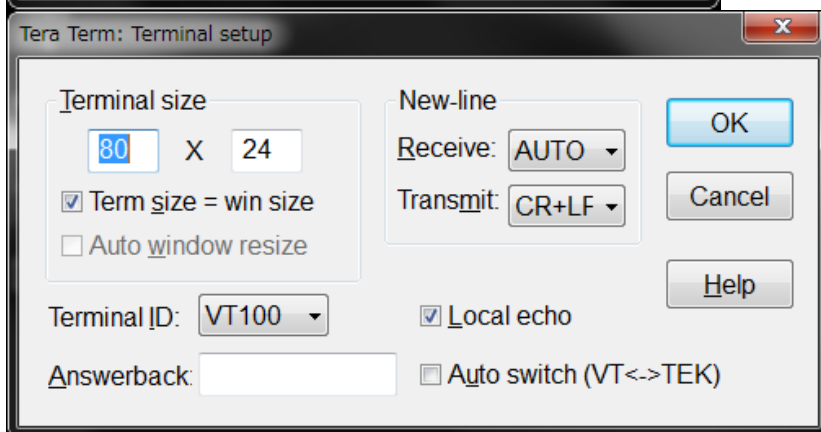
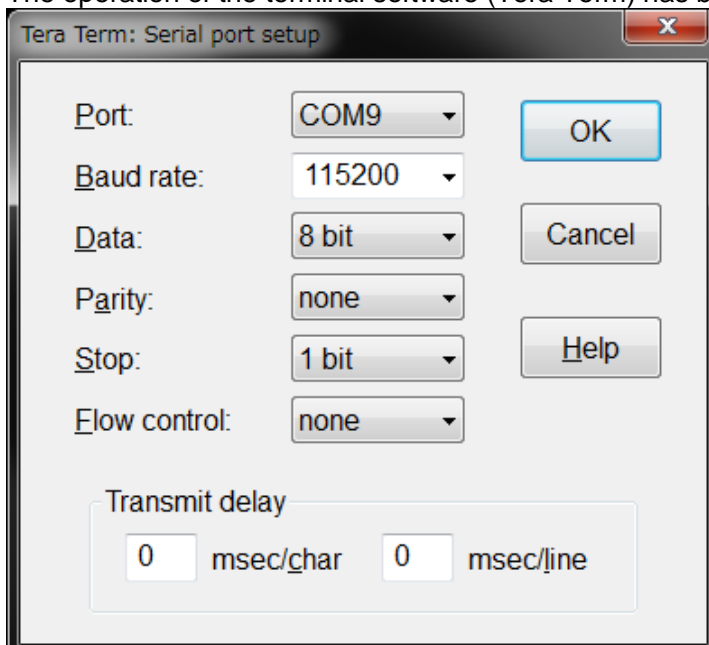

### 9.5. Operating Flow of Sample Program

The basic operating flows of the sample program are shown in the following;

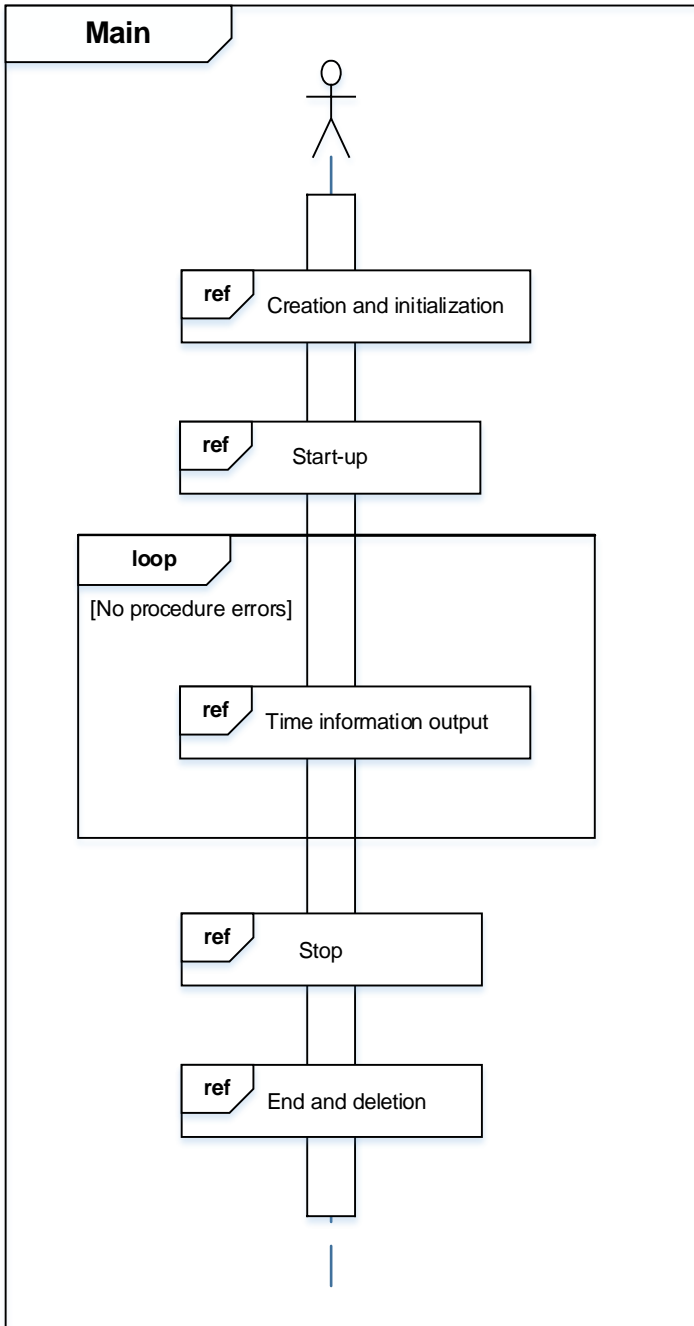

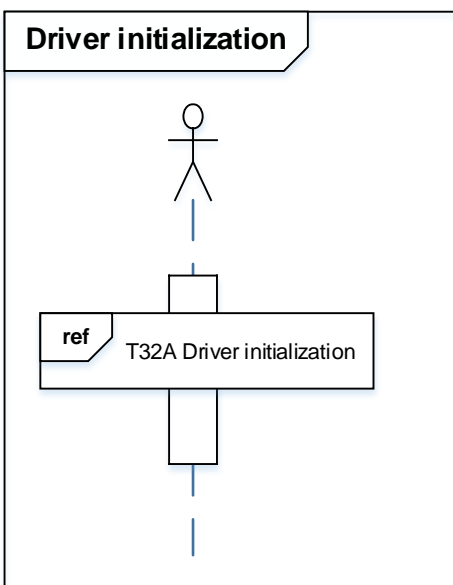
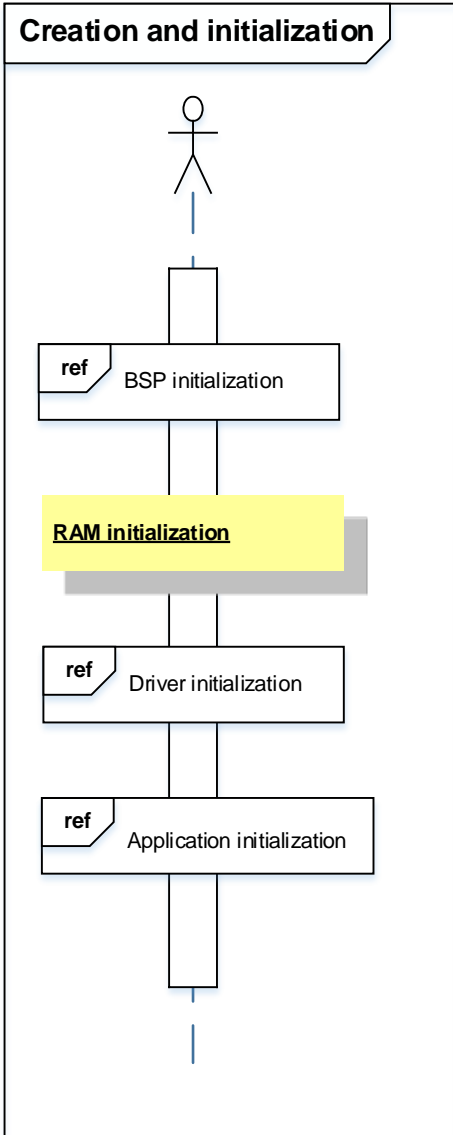

The 32-bit timer event counter of TPM4G9 is running, but processing using timer count is not performed.

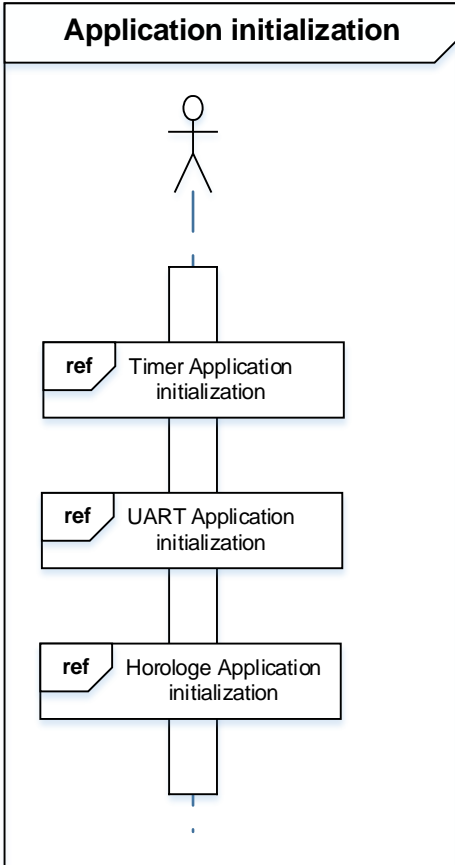
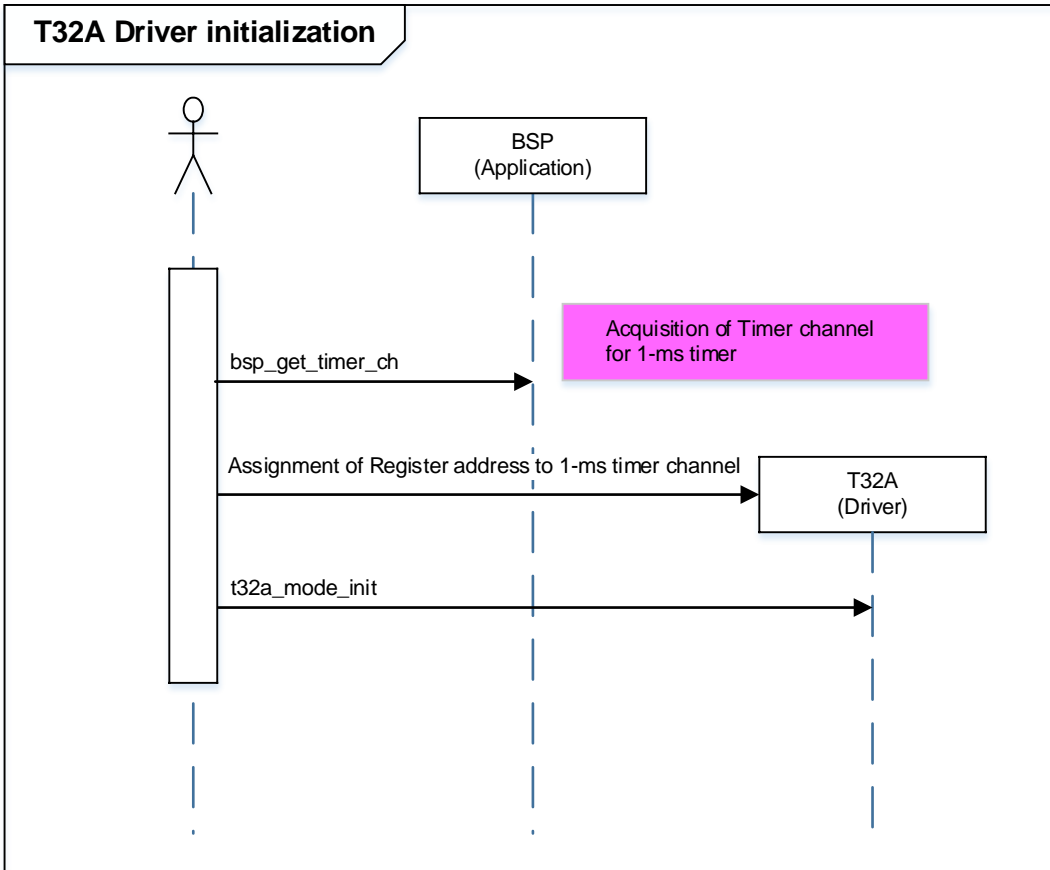

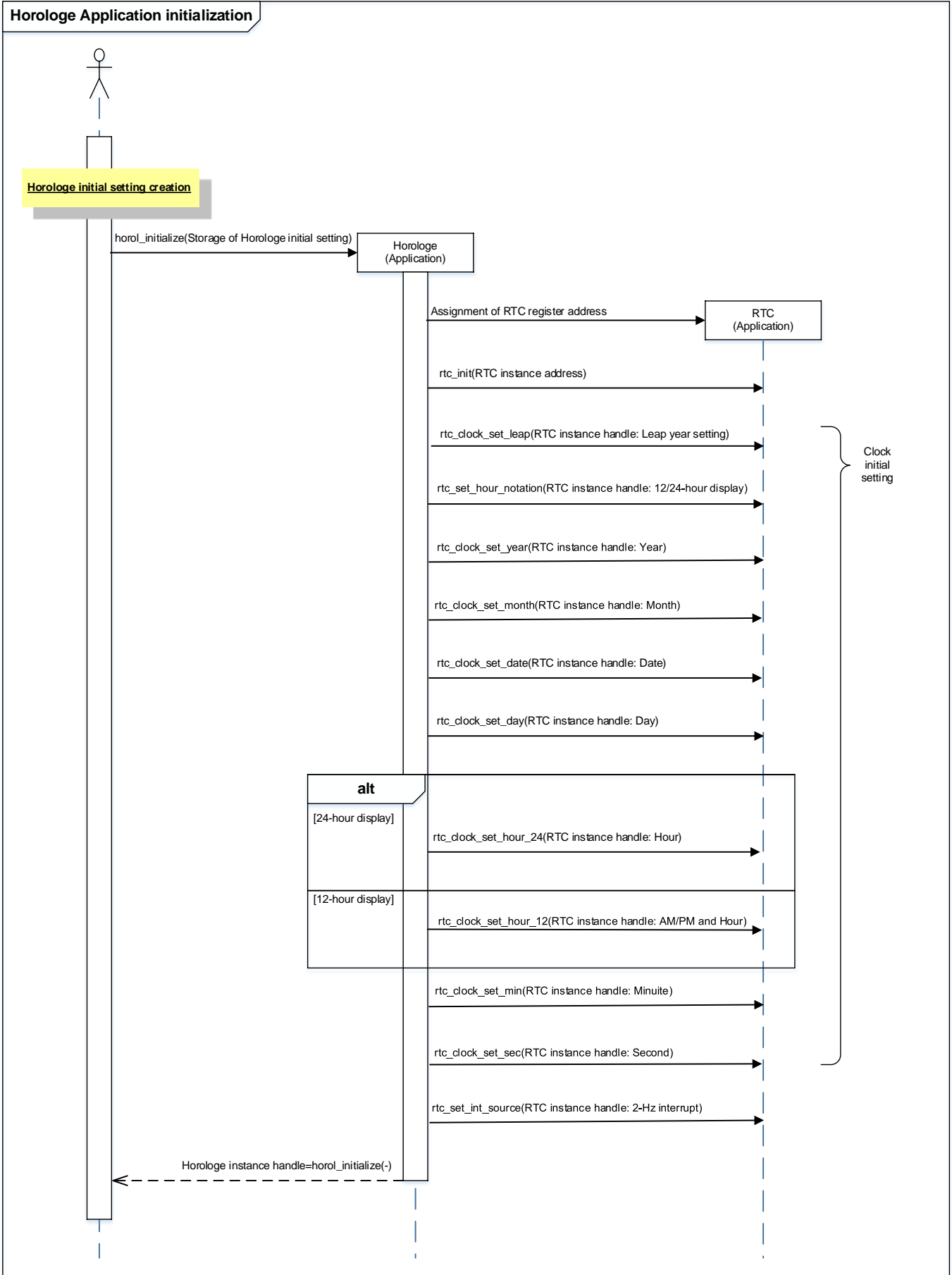

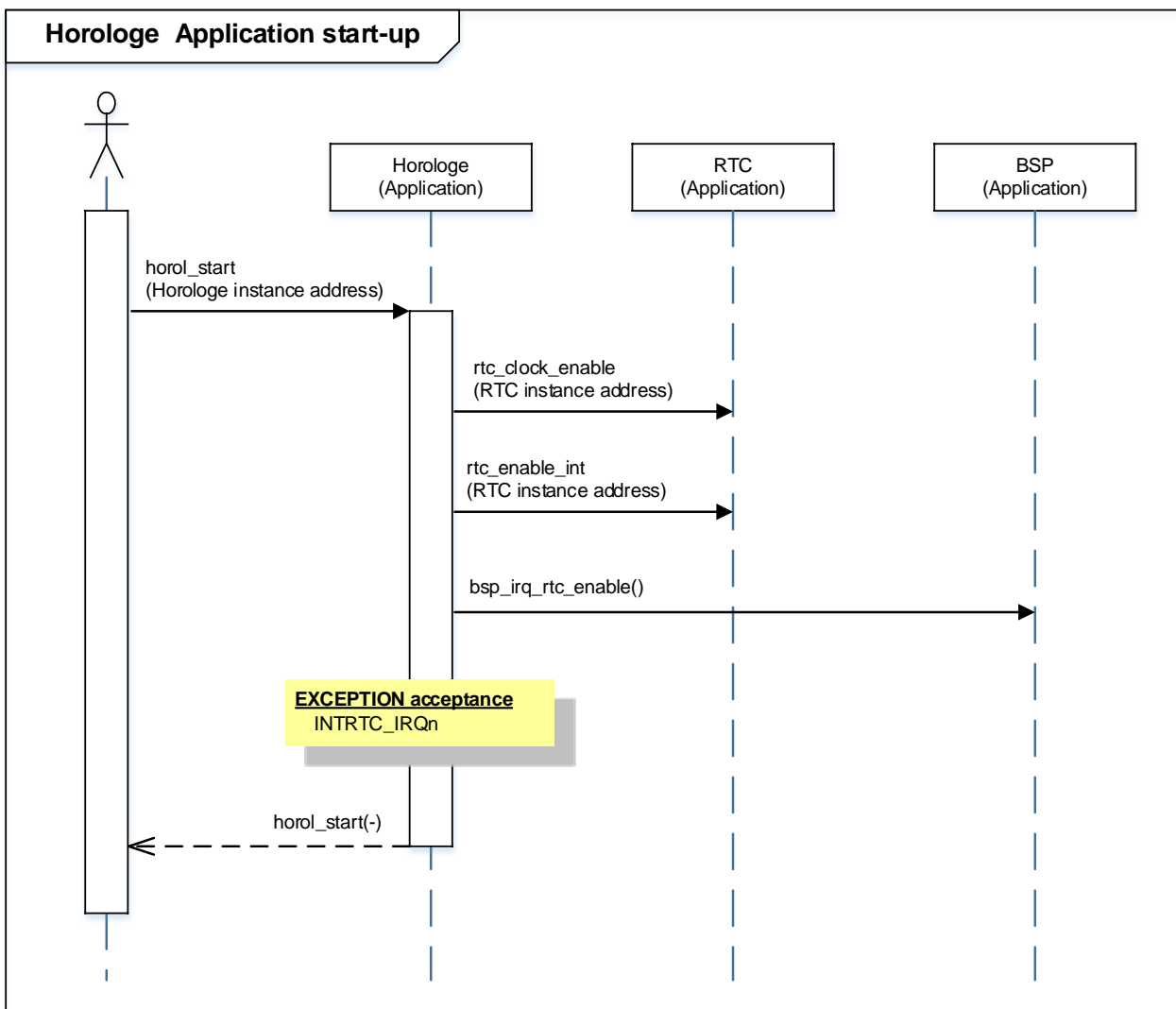
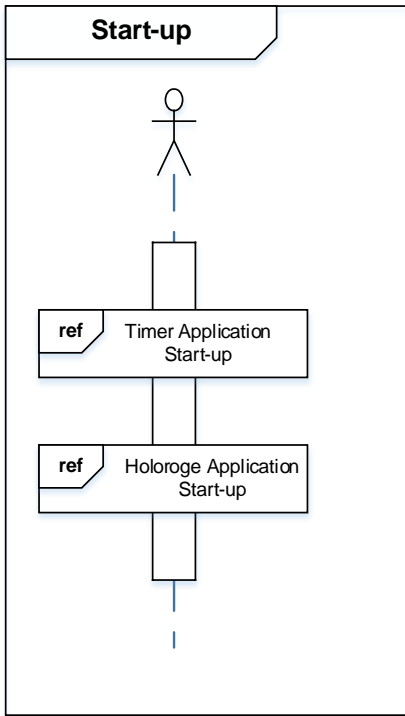

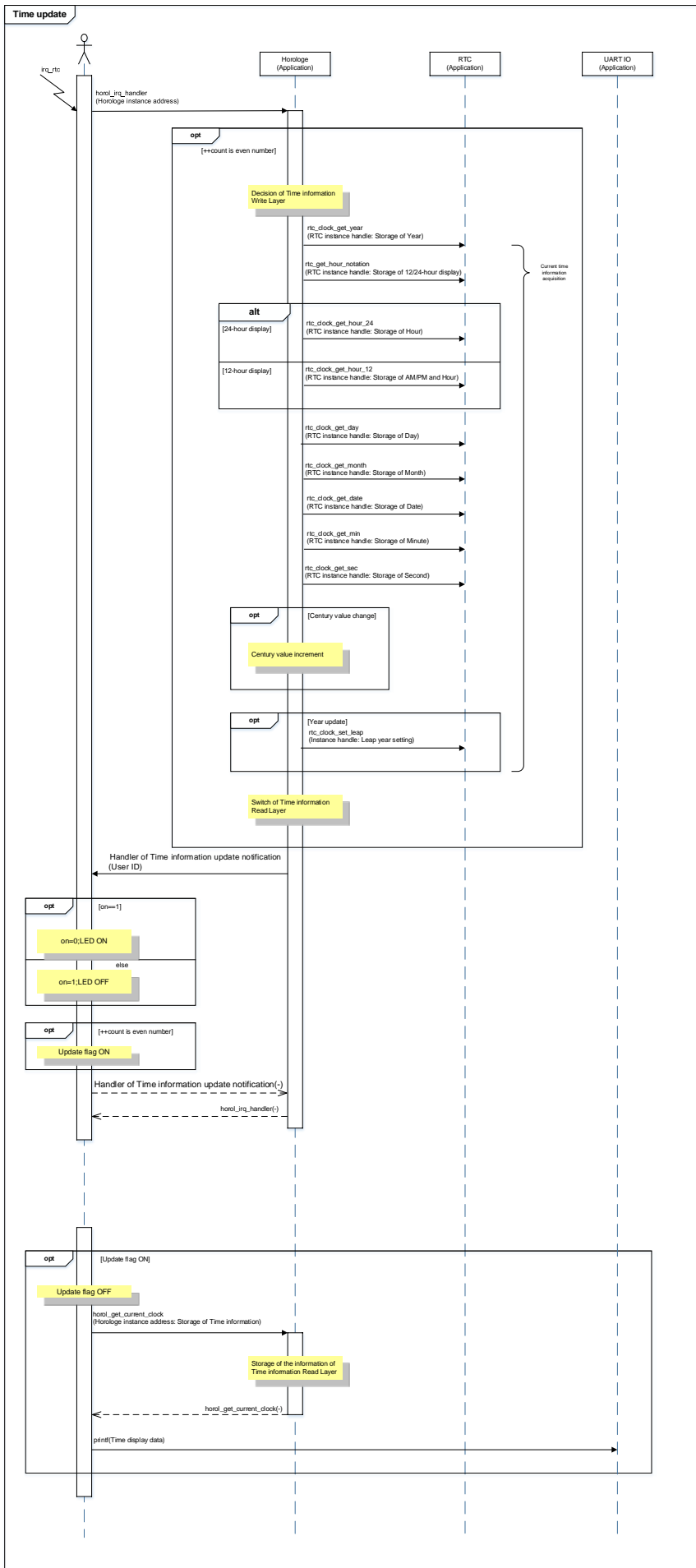

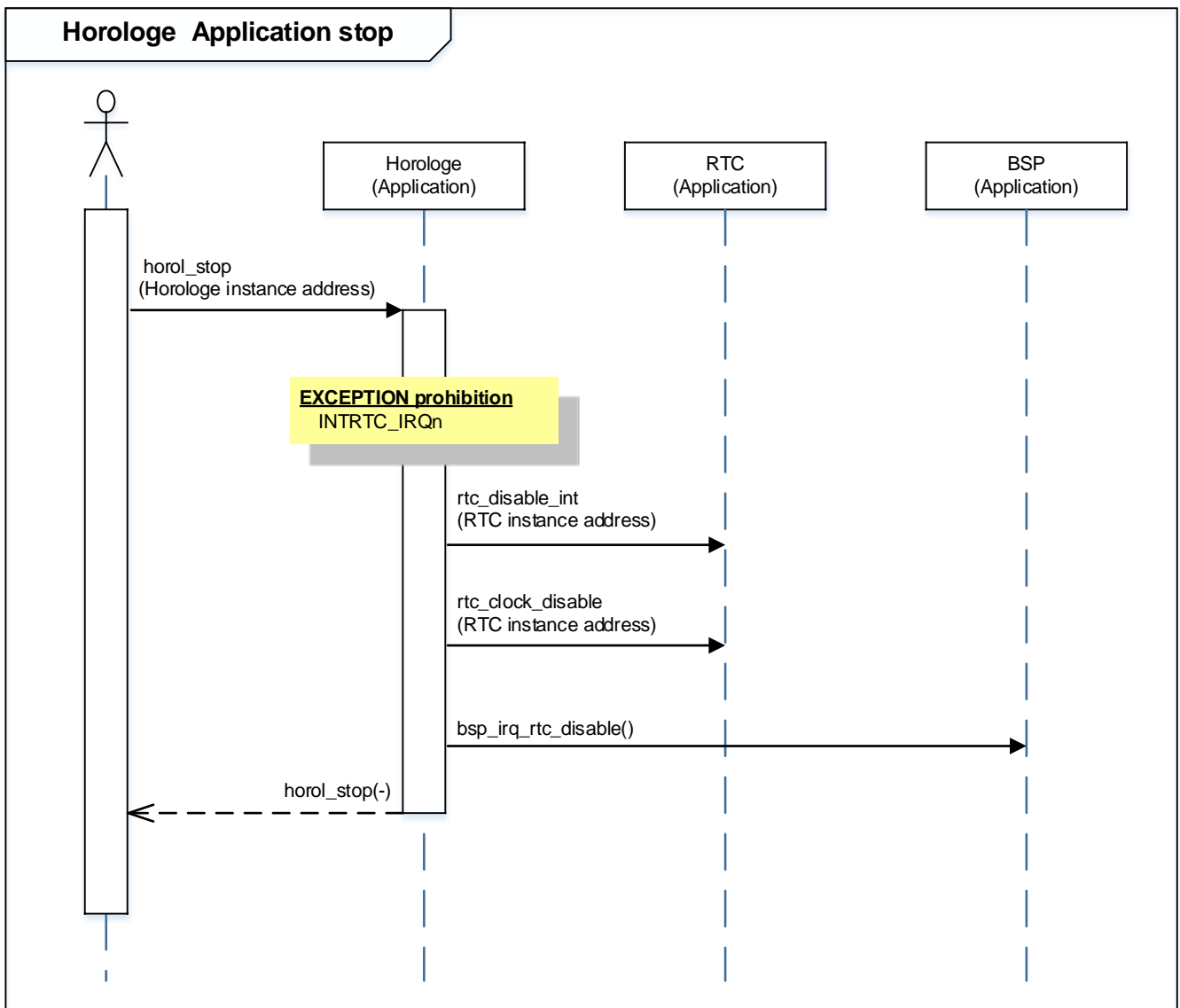
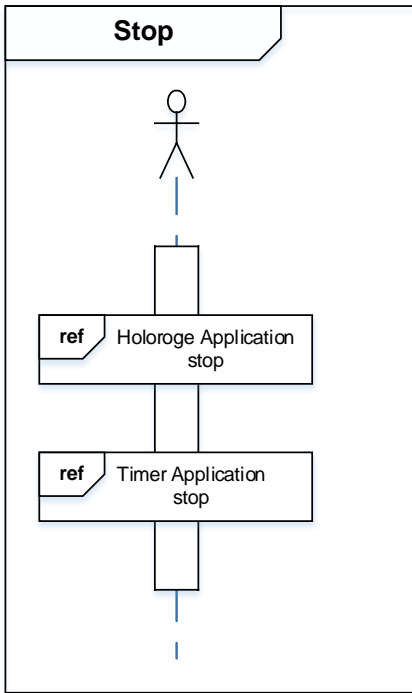



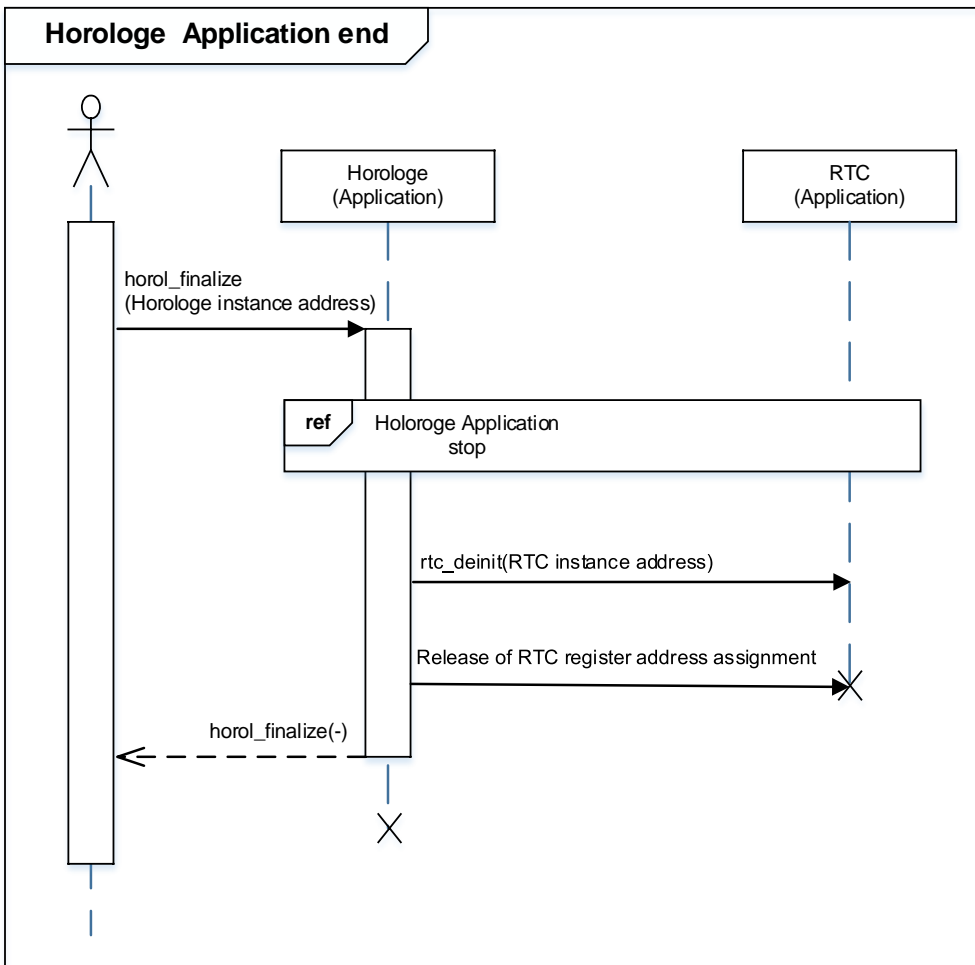
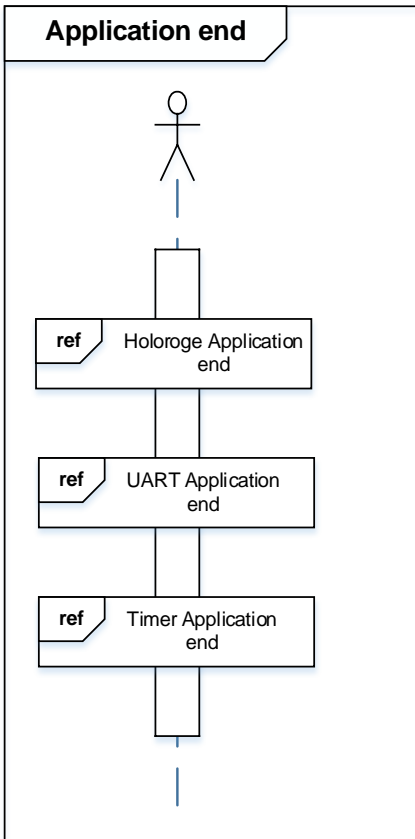

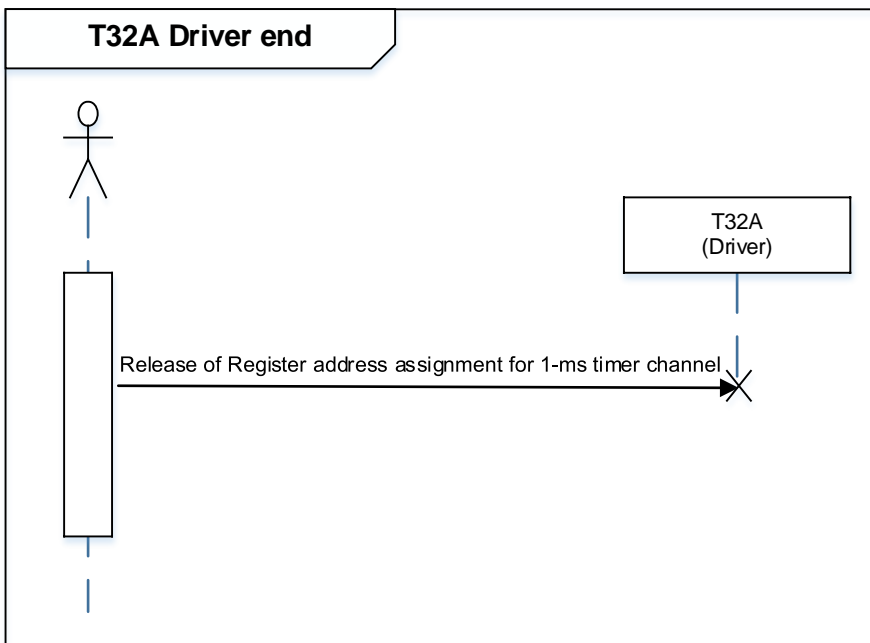
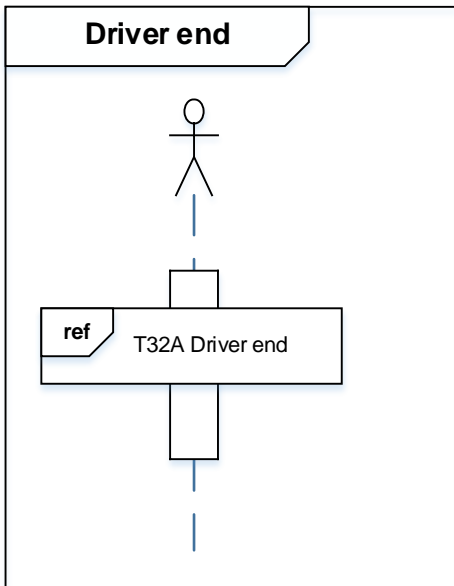

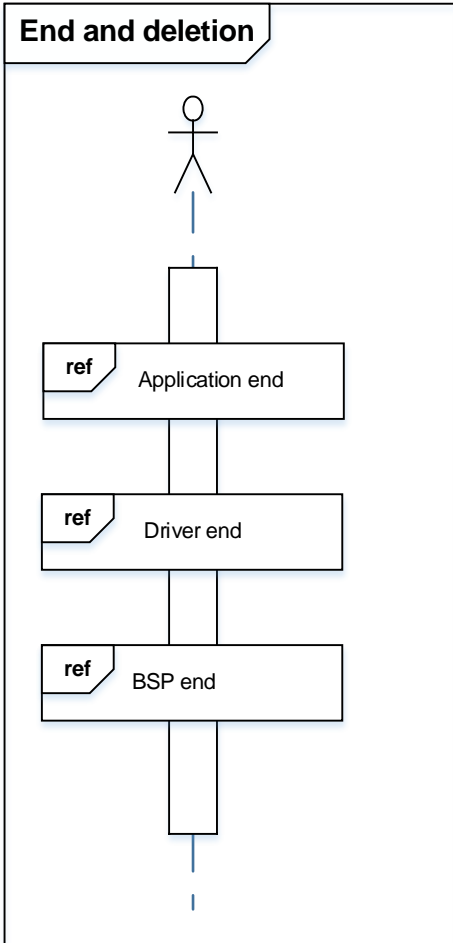

**10. Precaution**

When using the sample program with CPU other than TPM4G9F15, please check operation sufficiently.

**11. Revision History**

Rev	Date	Description
1.0	2018-12-14	First release

## RESTRICTIONS ON PRODUCT USE

Toshiba Corporation and its subsidiaries and affiliates are collectively referred to as "TOSHIBA". Hardware, software and systems described in this document are collectively referred to as "Product".

- TOSHIBA reserves the right to make changes to the information in this document and related Product without notice.
- This document and any information herein may not be reproduced without prior written permission from TOSHIBA. Even with TOSHIBA's written permission, reproduction is permissible only if reproduction is without alteration/omission.
- Though TOSHIBA works continually to improve Product's quality and reliability, Product can malfunction or fail. Customers are responsible for complying with safety standards and for providing adequate designs and safeguards for their hardware, software and systems which minimize risk and avoid situations in which a malfunction or failure of Product could cause loss of human life, bodily injury or damage to property, including data loss or corruption. Before customers use the Product, create designs including the Product, or incorporate the Product into their own applications, customers must also refer to and comply with (a) the latest versions of all relevant TOSHIBA information, including without limitation, this document, the specifications, the data sheets and application notes for Product and the precautions and conditions set forth in the "TOSHIBA Semiconductor Reliability Handbook" and (b) the instructions for the application with which the Product will be used with or for. Customers are solely responsible for all aspects of their own product design or applications, including but not limited to (a) determining the appropriateness of the use of this Product in such design or applications; (b) evaluating and determining the applicability of any information contained in this document, or in charts, diagrams, programs, algorithms, sample application circuits, or any other referenced documents; and (c) validating all operating parameters for such designs and applications. **TOSHIBA ASSUMES NO LIABILITY FOR CUSTOMERS' PRODUCT DESIGN OR APPLICATIONS.**
- **PRODUCT IS NEITHER INTENDED NOR WARRANTED FOR USE IN EQUIPMENTS OR SYSTEMS THAT REQUIRE EXTRAORDINARILY HIGH LEVELS OF QUALITY AND/OR RELIABILITY, AND/OR A MALFUNCTION OR FAILURE OF WHICH MAY CAUSE LOSS OF HUMAN LIFE, BODILY INJURY, SERIOUS PROPERTY DAMAGE AND/OR SERIOUS PUBLIC IMPACT ("UNINTENDED USE").** Except for specific applications as expressly stated in this document, Unintended Use includes, without limitation, equipment used in nuclear facilities, equipment used in the aerospace industry, lifesaving and/or life supporting medical equipment, equipment used for automobiles, trains, ships and other transportation, traffic signaling equipment, equipment used to control combustions or explosions, safety devices, elevators and escalators, and devices related to power plant. **IF YOU USE PRODUCT FOR UNINTENDED USE, TOSHIBA ASSUMES NO LIABILITY FOR PRODUCT.** For details, please contact your TOSHIBA sales representative or contact us via our website.
- Product shall not be used for or incorporated into any products or systems whose manufacture, use, or sale is prohibited under any applicable laws or regulations.
- The information contained herein is presented only as guidance for Product use. No responsibility is assumed by TOSHIBA for any infringement of patents or any other intellectual property rights of third parties that may result from the use of Product. No license to any intellectual property right is granted by this document, whether express or implied, by estoppel or otherwise.
- **ABSENT A WRITTEN SIGNED AGREEMENT, EXCEPT AS PROVIDED IN THE RELEVANT TERMS AND CONDITIONS OF SALE FOR PRODUCT, AND TO THE MAXIMUM EXTENT ALLOWABLE BY LAW, TOSHIBA (1) ASSUMES NO LIABILITY WHATSOEVER, INCLUDING WITHOUT LIMITATION, INDIRECT, CONSEQUENTIAL, SPECIAL, OR INCIDENTAL DAMAGES OR LOSS, INCLUDING WITHOUT LIMITATION, LOSS OF PROFITS, LOSS OF OPPORTUNITIES, BUSINESS INTERRUPTION AND LOSS OF DATA, AND (2) DISCLAIMS ANY AND ALL EXPRESS OR IMPLIED WARRANTIES AND CONDITIONS RELATED TO SALE, USE OF PRODUCT, OR INFORMATION, INCLUDING WARRANTIES OR CONDITIONS OF MERCHANTABILITY, FITNESS FOR A PARTICULAR PURPOSE, ACCURACY OF INFORMATION, OR NONINFRINGEMENT.**
- Do not use or otherwise make available Product or related software or technology for any military purposes, including without limitation, for the design, development, use, stockpiling or manufacturing of nuclear, chemical, or biological weapons or missile technology products (mass destruction weapons). Product and related software and technology may be controlled under the applicable export laws and regulations including, without limitation, the Japanese Foreign Exchange and Foreign Trade Law and the U.S. Export Administration Regulations. Export and re-export of Product or related software or technology are strictly prohibited except in compliance with all applicable export laws and regulations.
- Please contact your TOSHIBA sales representative for details as to environmental matters such as the RoHS compatibility of Product. Please use Product in compliance with all applicable laws and regulations that regulate the inclusion or use of controlled substances, including without limitation, the EU RoHS Directive. **TOSHIBA ASSUMES NO LIABILITY FOR DAMAGES OR LOSSES OCCURRING AS A RESULT OF NONCOMPLIANCE WITH APPLICABLE LAWS AND REGULATIONS.**