

# Low-Noise CMOS Operational Amplifier Ideal for Sensor Signal Amplification

## **Outline:**

This application note discusses how to obtain the best performance from low-noise op amps that are used to amplify a small signal from light, ultrasonic, vibration, and other sensors widely used in IoT devices. The TC75S67TU, Toshiba's CMOS ultra-low-noise op amp, is used as an example for discussion.

---

**Table of Contents**

Table of Contents ..... 2

**1. Introduction..... 3**

**2. Overview of a sensor and an amplifier circuit for a small signal ..... 4**

**3. Performance requirements for op amps for sensor signal amplification ..... 5**

**3.1 Impact of the noise of op amp circuits on sensing accuracy .....5**

**3.1.1 What is internal noise? .....6**

**3.1.2 What is external noise? .....7**

**3.2 Selecting an op amp with low input bias current to reduce a sensing error .....8**

**4. Op amp ideal for sensor signal amplifier circuits..... 8**

**4.1 Selecting an op amp with low internal noise .....8**

**4.2 Selecting external resistors to reduce externally generated noise .....9**

**4.3 CMOS op amp with low input bias current suitable for improving the accuracy of a sensor circuit..... 10**

**5. Summary ..... 11**

**RESTRICTIONS ON PRODUCT USE ..... 12**

## 1. Introduction

IoT and other applications incorporate various types of sensors to collect ambient data.

Commonly used sensors include motion sensors; pyroelectric infrared sensors for smoke alarms; ultrasonic and light sensors for distance measurement; infrared sensors for security systems and remote controllers; gas sensors for gas detectors; load cells for weight sensing; and shock sensors for vibration detection. In many cases, a small signal from a sensor is amplified with an op amp before being fed to an analog-digital converter (ADC).

Because most sensors provide a small analog signal, low-noise op amps are required for high-precision amplification.

This application note uses Toshiba's TC75S67TU ultra-low-noise CMOS op amp to describe how to obtain the best performance from low-noise op amps for the amplification of a small sensor signal.

## 2. Overview of a sensor and an amplifier circuit for a small signal

Since the output of a sensor is a small signal, a low-noise op amp is required for high-precision amplification. Figure 2.1 shows a diagram of a sensor circuit block.

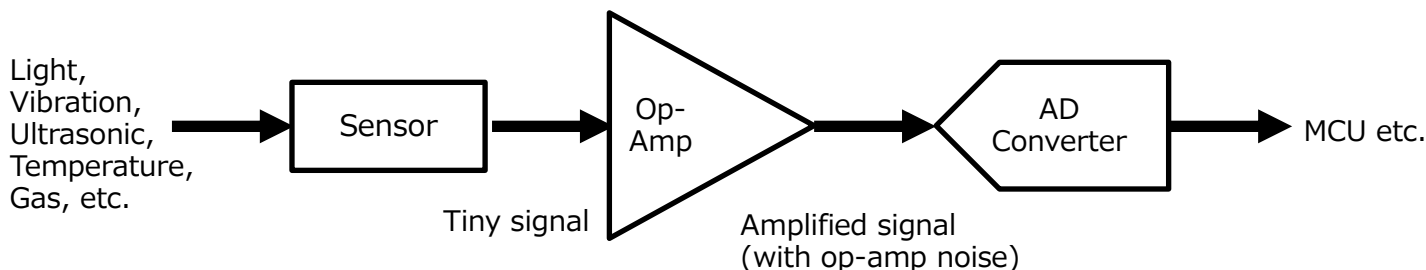

**Figure 2.1 Example of a sensor circuit block**

Examples of typical sensor circuits are described below:

### (1) Vibration sensor circuit

Figure 2.2 shows an example of a shock sensor circuit (charge amplifier circuit) using an op amp, which causes the charge output ( $Q_S$ ) to change in proportion to the magnitude of vibration applied to the shock sensor. This circuit consists of an op amp that amplifies a signal from the shock sensor and a feedback capacitor ( $C_f$ ).

### (2) Ultrasonic sensor circuit

Figure 2.3 shows an example of an ultrasonic sensor circuit (inverting amplifier circuit) using an op amp, which receives ultrasonic with an ultrasonic sensor and converts it into voltage. This circuit comprises an AC-coupling capacitor ( $C_c$ ), an input resistor ( $R_S$ ), and a feedback resistor ( $R_f$ ) in addition to a sensor.

### (3) Light sensor circuit

Figure 2.4 shows an example of a light sensor circuit (current-to-voltage converter circuit) using an op amp, in which a small current ( $I_S$ ) flows in proportion to the intensity of light received by a light sensor (photodiode, or PD for short). This circuit consists of a light sensor, an op amp that amplifies a signal from the sensor, a resistor ( $R_f$ ) for current-to-voltage conversion, and a capacitor ( $C_f$ ) for oscillation prevention.

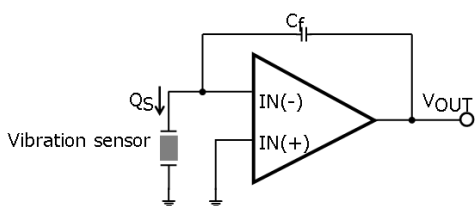

**Figure 2.2 Example of a typical shock sensor circuit (charge amplifier circuit)**

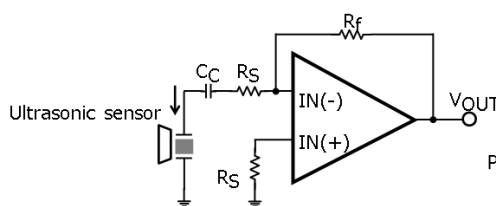

**Figure 2.3 Example of a typical ultrasonic sensor circuit (inverting amplifier circuit)**

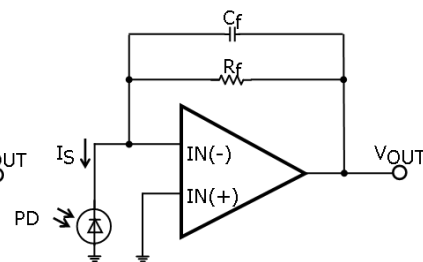
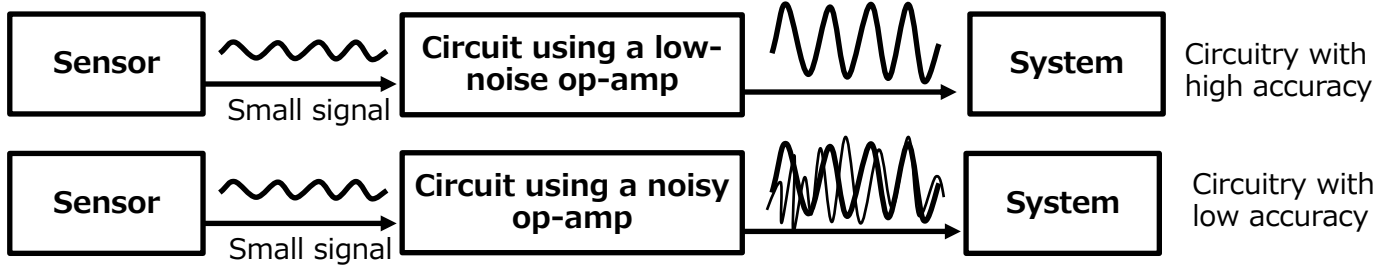

**Figure 2.4 Example of a typical light sensor circuit (current-to-voltage converter circuit)**

The next section discusses the performance required for op amps for major sensor applications.

## 3. Performance requirements for op amps for sensor signal amplification

### 3.1 Impact of the noise of op amp circuits on sensing accuracy

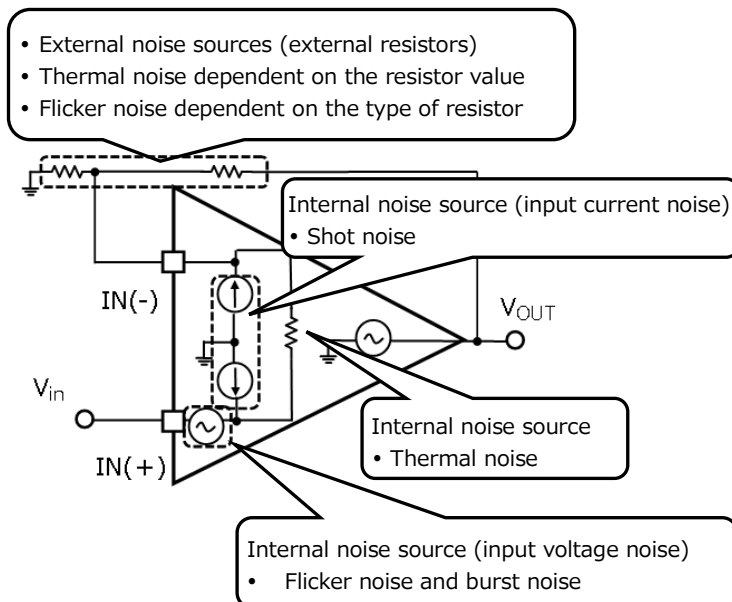

**Figure 3.1.1 Impact of the noise of op amp circuits on sensing accuracy**

Figure 3.1.1 shows the impact of op amps on sensing accuracy. When a small signal from a sensor is amplified by a noisy op amp, its noise is superimposed on the amplified sensor signal, degrading sensing accuracy. Resistors in the sensor circuit also affect the value of noise.

Op amp noise can be classified into external or internal noise, depending on its source. Internal noise is generated in the op amp whereas external noise is caused by a feedback resistor and other external components. Figure 3.1.2 shows the sources and types of op amp noise.

Figure 3.1.3 shows the noise frequency characteristics of an op amp.  $1/f$  noise is present in the low-frequency region whereas white noise is present across the whole frequency spectrum (see Table 1).



**Figure 3.1.2 Op amp circuit noise model**

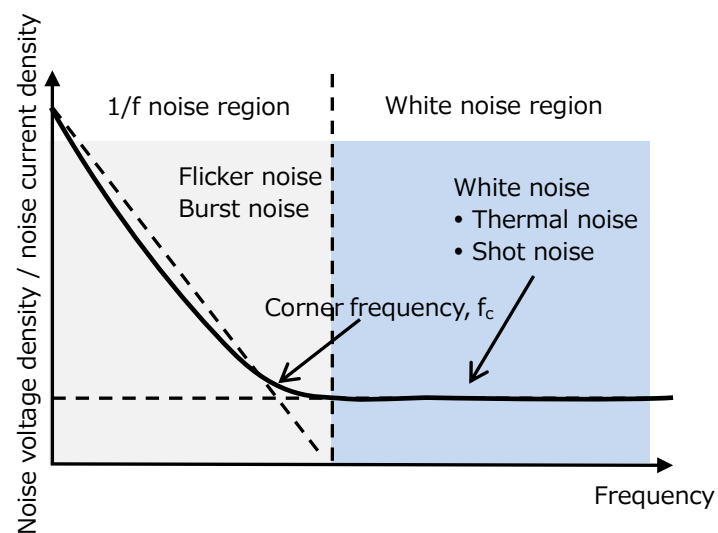

**Figure 3.1.3 Frequency characteristics of op amp circuit noise**

**Table 1 Noise frequency characteristics**

Source	Frequency Region	Dominant Noise	Cause of Noise
Internal	1/f region (low-frequency region)	Flicker noise, Burst noise	Effect of lattice defects in semiconductor
External		Flicker noise	Resistors
Internal	White noise region (whole frequency spectrum)	Shot noise	Current passing across the p-n junction of semiconductor
Internal External		Thermal noise	Op amp and external resistors; dependent on the resistor value

### 3.1.1 What is internal noise?

Internal noise is the noise generated within an op amp circuit. There are four main sources of internal noise.

#### (1) Thermal noise

Thermal noise is generated by resistors and MOSFETs that constitute an op amp circuit. Thermally excited electrons move irregularly among the atoms in a resistor, causing noise voltage to appear across the resistor even when there is no current flowing through it. Thermal noise ( $V_{NT}$ ) is expressed as:

$$V_{NT} = \sqrt{4kTB}$$

where  $k$  is the Boltzmann constant ( $1.38 \times 10^{-23}$ ) in J/K,  $T$  is absolute temperature in K,  $R$  is resistance in  $\Omega$ , and  $B$  is the frequency bandwidth in Hz.

This equation indicates that thermal noise increases with the resistor value.

#### (2) Flicker noise and burst noise

Flicker noise and burst noise are generated by the MOSFET and other elements in a CMOS op amp.

#### (3) Shot noise

Shot noise results whenever current crosses the potential barrier of a p-n junction.

Take, for example, a shock sensor circuit that is affected by internally generated noise.

The shock sensor circuit shown in Figure 2.2 uses a charge amplifier circuit. Let the output charge of the shock sensor be  $Q_S$  coulombs and the feedback capacitor value be  $C_f$ . Then, the output voltage of the op amp is expressed as  $V_{OUT} = \frac{Q_S}{C_f}$ . Letting the capacitance of the shock sensor be  $C_j$ , the noise gain ( $G_N$ ) of this circuit can be expressed as  $G_N = \frac{C_j}{C_f}$ . The equivalent input noise voltage of the op amp is increased  $G_N$  times, causing a sensor error. To reduce the sensor error, a low-noise op amp must be selected for this shock sensor circuit.

### 3.1.2 What is external noise?

External noise means the noise generated by resistors external to an op amp.

(1) Flicker noise

Resistors generate 1/f noise.

(2) Thermal noise

Resistors external to an op amp generate thermal noise ( $V_{NT}$ ), which is affected by the values of the above resistors and the ambient temperature.

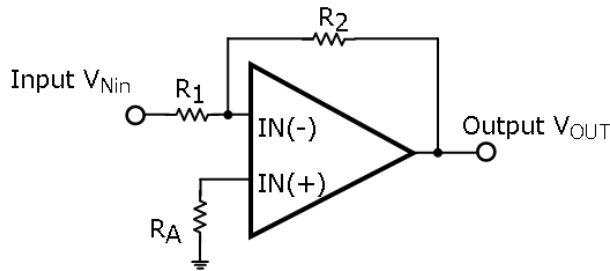

**Figure 3.1.4(a) Example of an inverting amplifier circuit Figure**

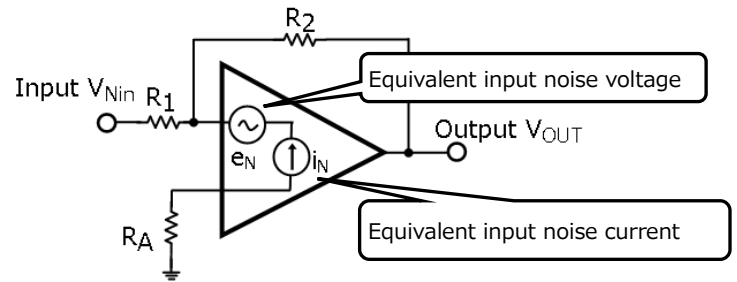

**3.1.4(b) Example of an inverting amplifier noise model**

The equivalent input noise voltage ( $V_{Nin}$ ) of the inverting amplifier circuit shown in Figure 3.1.4(b) can be calculated as follows:

- Thermal noise voltage density at the output due to resistors:  $V_{RN}$  ( $V_{rms}/\sqrt{Hz}$ )

$$V_{RN} = \sqrt{\left(-\frac{R_2}{R_1}\sqrt{4kTR_1}\right)^2 + \left\{\sqrt{4kTR_A}\left(1 + \frac{R_2}{R_1}\right)\right\}^2 + 4kTR_2}$$

- Output noise voltage:  $V_{eN}$  ( $V_{rms}/\sqrt{Hz}$ )

$$V_{eN} = e_N \left(1 + \frac{R_2}{R_1}\right), \text{ where } e_N \text{ is the equivalent input noise voltage density of an op amp.}$$

- Output current noise voltage density:  $V_{iN}$  ( $V_{rms}/\sqrt{Hz}$ )

$$V_{iN} = \sqrt{\left\{i_N + R_A \left(1 + \frac{R_2}{R_1}\right)\right\}^2 + (i_N - R_2)^2}, \text{ where } i_N \text{ is the equivalent input noise current noise density.}$$

Total noise voltage density at the output of an op amp ( $V_{NOUT}$ ) is expressed as follows in  $V_{rms}/\sqrt{Hz}$ :

$$V_{NOUT} = \sqrt{V_{RN}^2 + V_{eN}^2 + V_{iN}^2}$$

Hence, the equivalent input noise voltage of this circuit ( $V_{Nin}$ ) is calculated as follows in  $V_{rms}/\sqrt{Hz}$ :

$$V_{Nin} = \frac{V_{NOUT}}{\left|-\frac{R_2}{R_1}\right|}$$

For example, an ultrasonic sensor is affected by internally and externally generated noise.

The ultrasonic sensor shown in Figure 2.3 uses an inverting amplifier circuit. Let the output voltage of the ultrasonic sensor be  $V_C$ , the input resistor value be  $R_S$ , and the feedback resistor value be  $R_f$ . Then, the output voltage of the op amp can be expressed as  $V_{OUT} = -\frac{R_f}{R_s} \cdot V_C$ . This circuit is affected by the noise generated by external resistors in addition to the internal noise of the op amp.

It is therefore necessary to reduce both internally and externally generated noise.

### 3.2 Selecting an op amp with low input bias current to reduce a sensing error

The light sensor circuit shown in Figure 2.4 uses a current-to-voltage converter circuit. Let the output current of the sensor be  $I_S$  and the feedback resistor value be  $R_f$ . Then, the output voltage of the op amp can be expressed as  $V_{OUT} = I_S \cdot R_f$ . The output current of a photodiode, which varies with the input light intensity, is small—on the order of a few nanoamperes to a few microamperes. Consequently, if the input bias current ( $I_B$ ) of the op amp is large,  $V_{OUT} = I_B \cdot R_f$  appears as a sensing error. It is therefore necessary to select an op amp with minimal input bias current for this light sensor circuit.

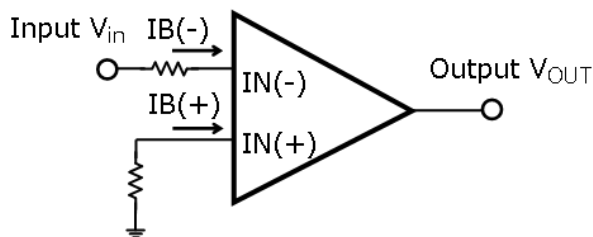

**Figure 3.1.5 Input bias current**

Toshiba’s TC75S67TU op amp provides a solution that meets all the requirements discussed in Section 3. The next section describes the TC75S67TU.

## 4. Op amp ideal for sensor signal amplifier circuits

### 4.1 Selecting an op amp with low internal noise

The TC75S67TU provides better noise performance than Toshiba’s previous CMOS op amps because of improvements in semiconductor process technology and op amp circuitry. Its typical equivalent input noise is  $16 \text{ nV}/\sqrt{\text{Hz}}$  (at  $f = 10 \text{ Hz}$ ) in the  $1/f$  region and  $6 \text{ nV}/\sqrt{\text{Hz}}$  (at  $f = 1 \text{ kHz}$ ) in the white noise region. The outstanding noise performance of the TC75S67TU makes it ideal for high-precision amplification of a sensor signal across the whole frequency spectrum. Equivalent input noise voltage ( $V_{NI}$ ) is dependent on the supply voltage ( $V_{DD}$ ). Figure 4.2 shows the  $V_{NI}$ - $V_{DD}$  curve of the TC75S67TU.

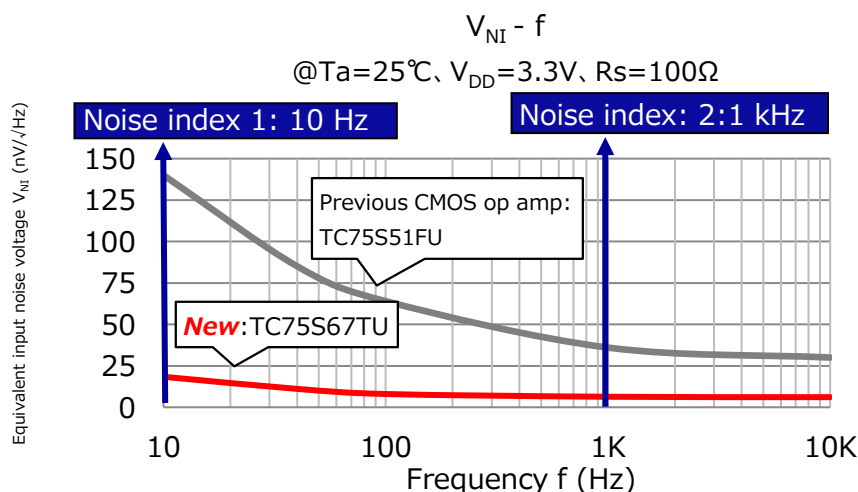

The equivalent input noise voltage of the TC75S67TU is roughly 86% lower at 10 Hz and roughly 82% lower at 1 kHz than that of Toshiba’s previous CMOS op amp.

**Figure 4.1 Typical equivalent input noise voltage-vs-frequency curve of the TC75S67TU**



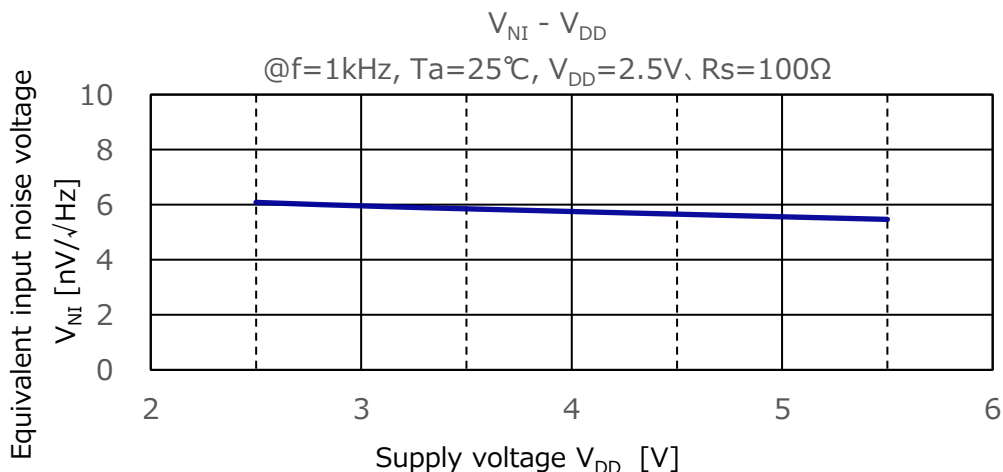

**Figure 4.2 Typical equivalent input noise voltage-vs-supply voltage curve of the TC75S67TU**

### 4.2 Selecting external resistors to reduce externally generated noise

An op amp’s external noise is mainly affected by:

- (1) External resistor type

Resistors generate 1/f noise caused by flicker noise, which can be reduced by using thin-film chip resistors or metal-film resistors instead of carbon-film resistors or thick-film chip resistors.

- (2) Thermal noise

The equations for the inverting amplifier circuit shown in the previous section indicate that thermal noise can be reduced by reducing the  $R_1$  and  $R_2$  values appropriately according to an op amp’s output current without changing their ratio ( $R_2/R_1$ ). Equivalent input current noise causes the equivalent input noise voltage ( $R_A$ ) to be multiplied ( $1+R_2/R_1$ ) times by the inverting amplifier circuit. In the case of typical bipolar op amps, resistor  $R_A$  helps reduce the input offset voltage generated by the bias current for the input pins,  $I_{N(+)}$  and  $I_{N(-)}$ . However,  $R_A$  has little such effect on the TC75S67TU because its input bias current is as small as roughly 1 pA. It is therefore unnecessary to connect  $R_A$  to the TC75S67TU to reduce thermal noise. Just for reference, Figure 4.3 shows an equivalent input noise voltage ( $V_{NI}$ )-vs-signal source resistance ( $R_A$ ) curve for the circuit shown in Figure 3.1.4.

The thermal noise ( $V_{NT}$ ) of a resistor is affected by temperature and frequency bandwidth as described in Section 3.1.1. Therefore, thermal noise can be reduced by: 1) reducing the resistor value, 2) minimizing the frequency bandwidth, and 3) reducing a circuit’s operating temperature.

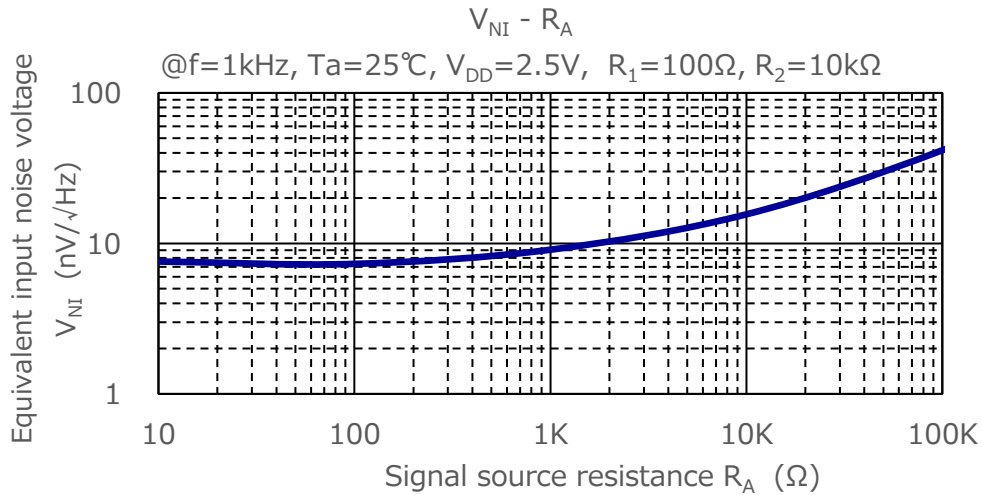

**Figure 4.3 Typical equivalent input noise voltage-vs-signal source resistance curve of the TC75S67TU**

**4.3 CMOS op amp with low input bias current suitable for improving the accuracy of a sensor circuit**

As described in the preceding subsection, the input bias current for an op amp could greatly affect the accuracy of a sensor circuit. Fabricated using a CMOS process, the TC75S67TU op amp provides a typical input bias current of 1 pA (at  $T_a=25^\circ\text{C}$ ), several orders of magnitude smaller than that of typical bipolar op amps with an input bias current of a few nanoamperes. Consequently, the TC75S67TU has very little adverse effect on the accuracy of a sensor circuit and is therefore the ideal choice for sensor circuit applications.

## 5. Summary

IoT and other devices are expected to continue to drive the demand for various sensors. It is necessary to further enhance the accuracy of sensor circuits so as to improve the performance of the applications incorporating them. Toshiba's TC75S67TU CMOS op amp with low noise and low input bias current is designed to amplify a small sensor signal with high precision. The TC75S67TU provides the optimum solution for various sensor signal amplifier circuits. For details of its electrical characteristics, see its datasheet.

Ultra-low-noise op amps:

To download the datasheet for the TC75S67TU→ [Click Here](#)

For other op amp circuit designs, see the application note Basic Operational Amplifier and Comparator Circuits.

To download Basic Operational Amplifier and Comparator Circuits→ [Click Here](#)

To view the lineup of other op amps→ [Click Here](#)

## RESTRICTIONS ON PRODUCT USE

Toshiba Corporation and its subsidiaries and affiliates are collectively referred to as "TOSHIBA". Hardware, software and systems described in this document are collectively referred to as "Product".

- TOSHIBA reserves the right to make changes to the information in this document and related Product without notice.
- This document and any information herein may not be reproduced without prior written permission from TOSHIBA. Even with TOSHIBA's written permission, reproduction is permissible only if reproduction is without alteration/omission.
- Though TOSHIBA works continually to improve Product's quality and reliability, Product can malfunction or fail. Customers are responsible for complying with safety standards and for providing adequate designs and safeguards for their hardware, software and systems which minimize risk and avoid situations in which a malfunction or failure of Product could cause loss of human life, bodily injury or damage to property, including data loss or corruption. Before customers use the Product, create designs including the Product, or incorporate the Product into their own applications, customers must also refer to and comply with (a) the latest versions of all relevant TOSHIBA information, including without limitation, this document, the specifications, the data sheets and application notes for Product and the precautions and conditions set forth in the "TOSHIBA Semiconductor Reliability Handbook" and (b) the instructions for the application with which the Product will be used with or for. Customers are solely responsible for all aspects of their own product design or applications, including but not limited to (a) determining the appropriateness of the use of this Product in such design or applications; (b) evaluating and determining the applicability of any information contained in this document, or in charts, diagrams, programs, algorithms, sample application circuits, or any other referenced documents; and (c) validating all operating parameters for such designs and applications. **TOSHIBA ASSUMES NO LIABILITY FOR CUSTOMERS' PRODUCT DESIGN OR APPLICATIONS.**
- **PRODUCT IS NEITHER INTENDED NOR WARRANTED FOR USE IN EQUIPMENTS OR SYSTEMS THAT REQUIRE EXTRAORDINARILY HIGH LEVELS OF QUALITY AND/OR RELIABILITY, AND/OR A MALFUNCTION OR FAILURE OF WHICH MAY CAUSE LOSS OF HUMAN LIFE, BODILY INJURY, SERIOUS PROPERTY DAMAGE AND/OR SERIOUS PUBLIC IMPACT ("UNINTENDED USE").** Except for specific applications as expressly stated in this document, Unintended Use includes, without limitation, equipment used in nuclear facilities, equipment used in the aerospace industry, lifesaving and/or life supporting medical equipment, equipment used for automobiles, trains, ships and other transportation, traffic signaling equipment, equipment used to control combustions or explosions, safety devices, elevators and escalators, and devices related to power plant. **IF YOU USE PRODUCT FOR UNINTENDED USE, TOSHIBA ASSUMES NO LIABILITY FOR PRODUCT.** For details, please contact your TOSHIBA sales representative or contact us via our website.
- Do not disassemble, analyze, reverse-engineer, alter, modify, translate or copy Product, whether in whole or in part.
- Product shall not be used for or incorporated into any products or systems whose manufacture, use, or sale is prohibited under any applicable laws or regulations.
- The information contained herein is presented only as guidance for Product use. No responsibility is assumed by TOSHIBA for any infringement of patents or any other intellectual property rights of third parties that may result from the use of Product. No license to any intellectual property right is granted by this document, whether express or implied, by estoppel or otherwise.
- **ABSENT A WRITTEN SIGNED AGREEMENT, EXCEPT AS PROVIDED IN THE RELEVANT TERMS AND CONDITIONS OF SALE FOR PRODUCT, AND TO THE MAXIMUM EXTENT ALLOWABLE BY LAW, TOSHIBA (1) ASSUMES NO LIABILITY WHATSOEVER, INCLUDING WITHOUT LIMITATION, INDIRECT, CONSEQUENTIAL, SPECIAL, OR INCIDENTAL DAMAGES OR LOSS, INCLUDING WITHOUT LIMITATION, LOSS OF PROFITS, LOSS OF OPPORTUNITIES, BUSINESS INTERRUPTION AND LOSS OF DATA, AND (2) DISCLAIMS ANY AND ALL EXPRESS OR IMPLIED WARRANTIES AND CONDITIONS RELATED TO SALE, USE OF PRODUCT, OR INFORMATION, INCLUDING WARRANTIES OR CONDITIONS OF MERCHANTABILITY, FITNESS FOR A PARTICULAR PURPOSE, ACCURACY OF INFORMATION, OR NONINFRINGEMENT.**
- Do not use or otherwise make available Product or related software or technology for any military purposes, including without limitation, for the design, development, use, stockpiling or manufacturing of nuclear, chemical, or biological weapons or missile technology products (mass destruction weapons). Product and related software and technology may be controlled under the applicable export laws and regulations including, without limitation, the Japanese Foreign Exchange and Foreign Trade Law and the U.S. Export Administration Regulations. Export and re-export of Product or related software or technology are strictly prohibited except in compliance with all applicable export laws and regulations.
- Please contact your TOSHIBA sales representative for details as to environmental matters such as the RoHS compatibility of Product. Please use Product in compliance with all applicable laws and regulations that regulate the inclusion or use of controlled substances, including without limitation, the EU RoHS Directive. **TOSHIBA ASSUMES NO LIABILITY FOR DAMAGES OR LOSSES OCCURRING AS A RESULT OF NONCOMPLIANCE WITH APPLICABLE LAWS AND REGULATIONS.**