

M4K Group (1)
Application Note
32-bit Timer Event Counter
(T32A-B)
Programmable Rectangular Wave
Output Function

Outlines

This application note is a reference material for developing products using the Programmable Rectangular Wave Output Function of the 32-bit timer event counter (T32A) of M4K Group (1). This document helps the user check operation of the product and develop its program.

Target sample program: Timer_PPG

Table of Contents

Outlines	1
Table of Contents	2
1. Preface	4
2. Reference Document	4
3. Function to Use	4
4. Target Device	4
5. Operation Confirmation Condition	5
6. Evaluation Board Operation	5
7. Sample Program	6
7.1. Structure Diagram of Sample Program	6
7.2. Startup Routine	6
7.3. Main Operation	6
7.4. Change of Duty Setting	8
7.5. Output Example of Terminal Software	9
7.5.1. Setting Example of Terminal Software	9
7.6. Operating Flow of Sample Program	10
8. Points to Remember on Handling of Sample Programs	19
9. Revision History	19
RESTRICTIONS ON PRODUCT USE	20

Arm and Keil are registered trademarks of Arm Limited (or its subsidiaries) in the US and/or elsewhere.

All other company names, product names, and service names mentioned herein may be trademarks of their respective companies.

1. Preface

This sample program is used to check the function of the 32-bit timer event counter.

Using the PPG function of the T32A, this sample program outputs the pulses whose Duty ratios are preprogrammed.

When a push switch is pushed down, a Duty ratio is changed to another value. The Duty ratio of the PPG output pulse becomes, per pushed-down, 10 %, 25 %, 50 %, 75%, or 90%, one after the other.

2. Reference Document

1. Datasheet
TMPM4K Group (1) datasheet Rev2.0 (Japanese edition)
2. Reference manual
32-bit Timer Event Counter (T32A-B) Rev3.0 (Japanese edition)
Input/Output Ports (PORT-M4K(1)) Rev2.0 (Japanese edition)
Asynchronous Serial Communication Circuit (UART-C) Rev3.0 (Japanese edition)
3. Application note
M4K Group (1) Application Note Startup (CMSIS System & Clock Configuration) Rev1.0
4. Other reference document
TMPM4KxA Group Peripheral Driver User Manual (Doxygen) V1.0.4.0

3. Function to Use

IP	Channel	Port	Function/Operation mode
32-bit Timer Event Counter	ch3	PC0 (T32A03OUTA)	PPG output
	ch0	-	Timer interrupt
Input/Output Ports	-	PE2 (Input Port)	Input
		PE3 (Input Port)	
Asynchronous Serial Communication Circuit	ch0	PK0 (UT0RXD) PK1 (UT0TXDA)	UART mode

4. Target Device

The target devices of this application note are as follows;

TMPM4K4FYAUG	TMPM4K4FWAUG	TMPM4K4FUAUG	TMPM4K4FSAUG
TMPM4K4FYAFG	TMPM4K4FWAFG	TMPM4K4FUAFG	TMPM4K4FSAFG
TMPM4K2FYADUG	TMPM4K2FWADUG	TMPM4K2FUADUG	TMPM4K2FSADUG
TMPM4K1FYAUG	TMPM4K1FWAUG	TMPM4K1FUAUG	TMPM4K1FSAUG
			TMPM4K0FSADUG

* This sample program operates on the evaluation board of TMPM4K4FYAUG.

If other function than the TMPM4K4 one is checked, it is necessary that CMSIS Core related files (the startup file and I/O header file) should be changed properly.

Additionally, the name of microcontroller which is set to the project should be changed.

The BSP related file is dedicated to the evaluation board (TMPM4K4FYAUG). If other function than the TMPM4K4 one is checked, the BSP related file should be changed properly.

5. Operation Confirmation Condition

Used microcontroller	TMPM4K4FYAUG
Used board	TMPM4K4 evaluation board (Product of ESP-kikaku Co. Ltd.)
Integrated development environment	IAR Embedded Workbench for ARM 8.22.2
Integrated development environment	Arm® Keil® MDK Version 5.24.2.0
Terminal software	Tera Term V4.96
Sample program	v1.0.0

6. Evaluation Board Operation

Board	Function
Push switch (SW1)	PPG output
Push switch (SW2)	Duty change

A PC should be connected to the USB_UART connector to communicate with the terminal software.

The push switch (SW1) is pushed down, the PPG pulse is output and the Duty ratio value is displayed to the terminal software.

When the push switch (SW2) is pushed down, the PPG output stops and the Duty ratio is changed to another value. The Duty ration becomes, per push-down, 10 %, 25 %, 50 %, 75 %, 90 %, and 10% again, one after the other.

The rectangular wave output with the set Duty ratio can be checked on the PC0.

7. Sample Program

7.1. Structure Diagram of Sample Program

The structure diagram of the sample program is shown below.

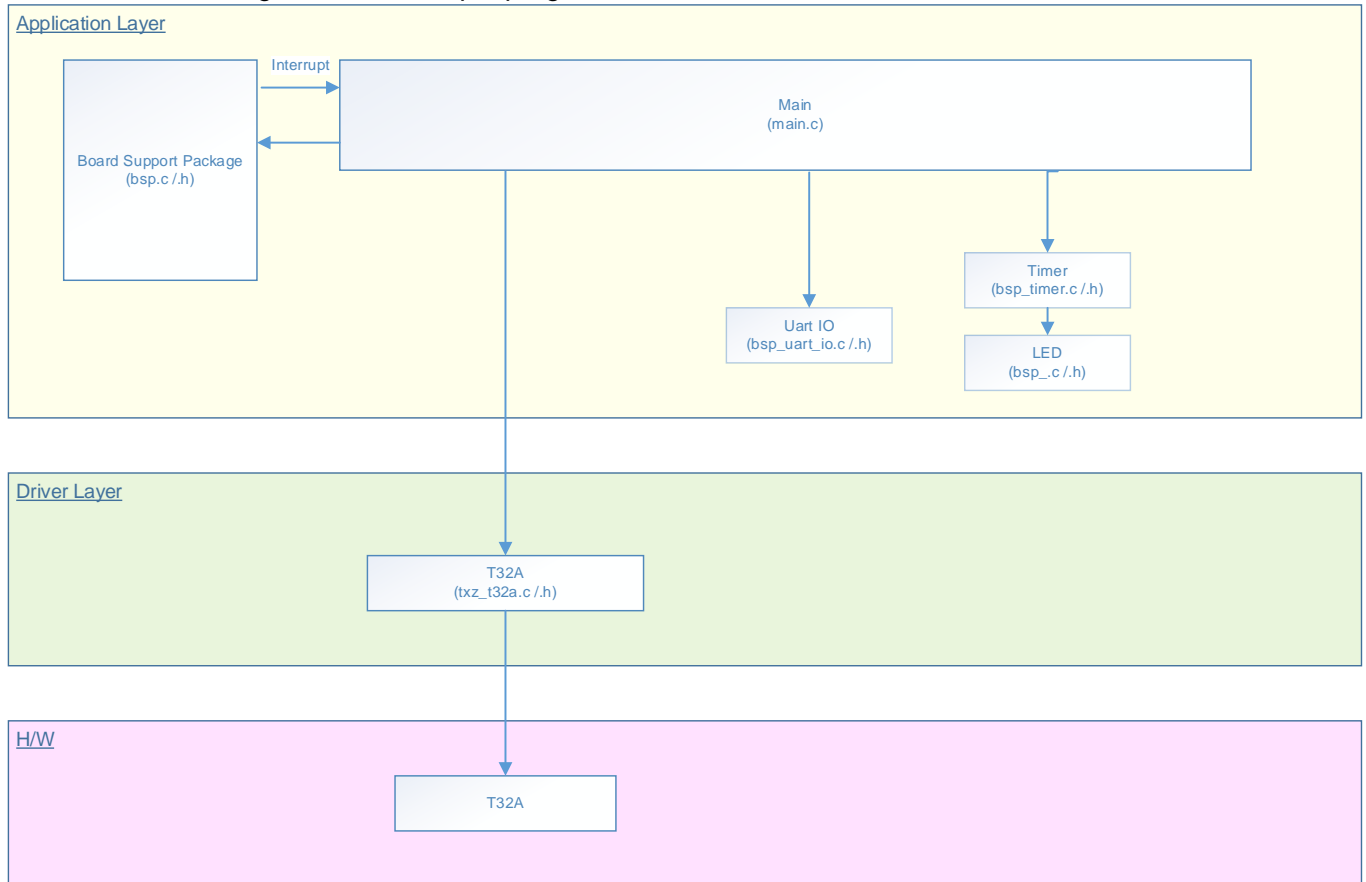

7.2. Startup Routine

The following initialization is done after power is supplied.

The initialization of each clock setting and the initialization of the watchdog timer setting are done.

7.3. Main Operation

The initialization of the BSP should be done.

The initialization of the variables should be done.

The initialization of the PPG and the initialization of the interrupt should be done as the initialization of the Timer driver.

The initialization of USB_UART and the initialization of the push switches should be done as the initialization of the application software.

The Timer is started.

The initial Duty ratio value is output to the terminal software.

After that, the sample program waits for an input of the push switch.

The push switch (SW1) is pushed down, the pulse whose Duty ratio is set by the other push switch (SW2) is output to the port.

When the push switch (SW2) is pushed down, the PPG output stops and the Duty ratio is changed to another value. The Duty ratio becomes, per push-down, 10 %, 25 %, 50 %, 75 %, 90 %, and 10% again, one after the other.

Then, the sample program waits for an input. The process above repeats.

The following example is an output wave with the Duty ratio of 25 %.

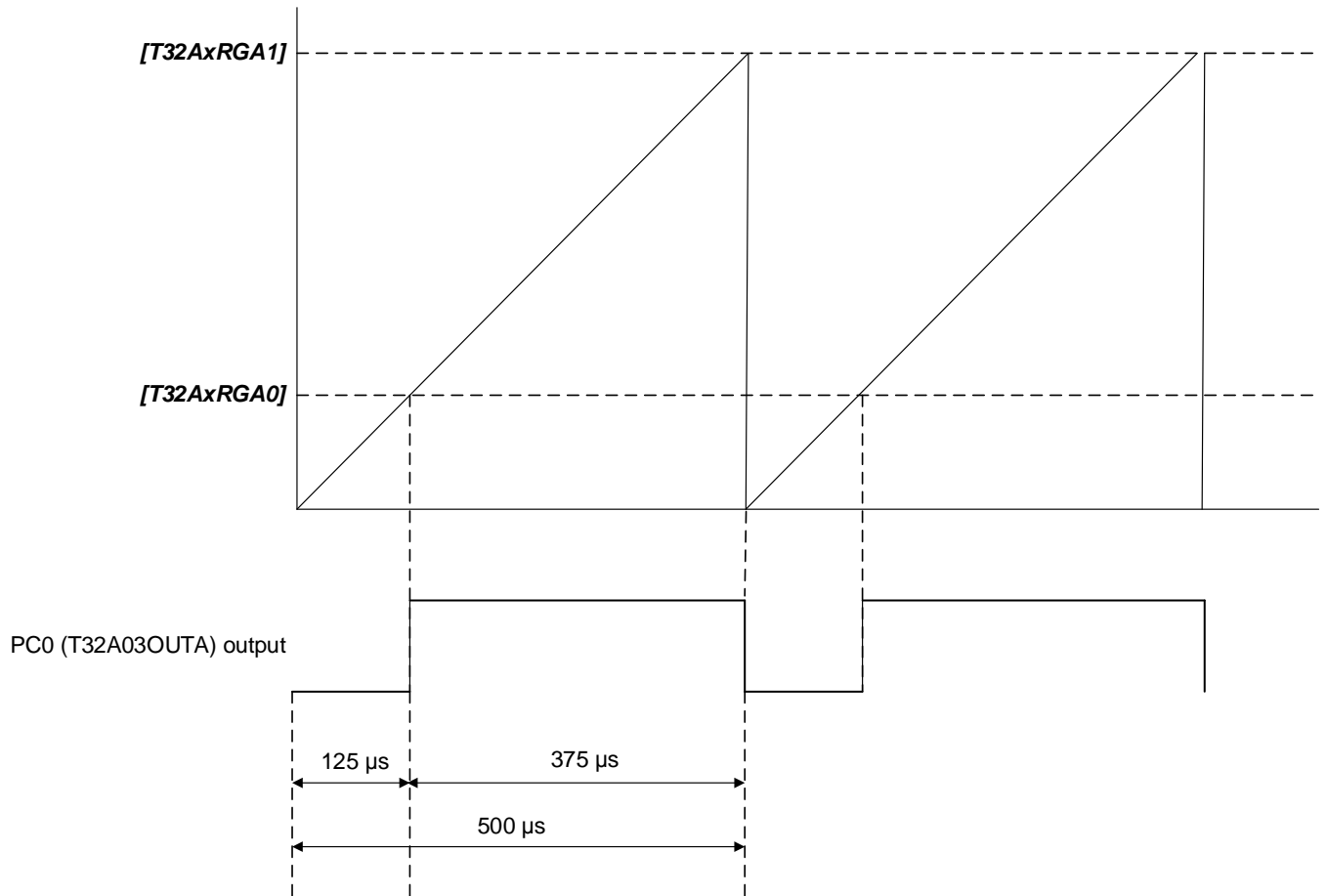

7.4. Change of Duty Setting

When the Duty ratio is changed, the following setting should be modified in the 87th line in the “main.c”
`static uint32_t tgtRisingTiming[5U] = { 10U, 25U, 50U, 75U, 90U };`
 5 values among 10 % to 90 % are set above.

The pulse cycle is set in the 366th line.
`p_pulse->init.pulse_trailing = 500U;`
 The initial value is 500 μ s.

The rise timing is set in the 560th line.
`RisingTimingus[i] = tgtRisingTiming[i] * 5U;`

The pulse setting is as follows;
 The setting of the pulse cycle: p_pulse
 The setting of the pulse rise timing: RisingTimingus

When the pulse width is changed, the change of pulse cycle should be set and the rising timing should be set properly according to the changed cycle.

Example: The pulse cycle is set to 600 μ s.
`p_pulse->init.pulse_trailing = 600U;`

In this case, the multiple value for the rising timing should be set to 1/100 of the pulse cycle, that is, 6U to output the pulse which has a proper Duty ratio.

`RisingTimingus[i] = tgtRisingTiming[i] * 6U;`

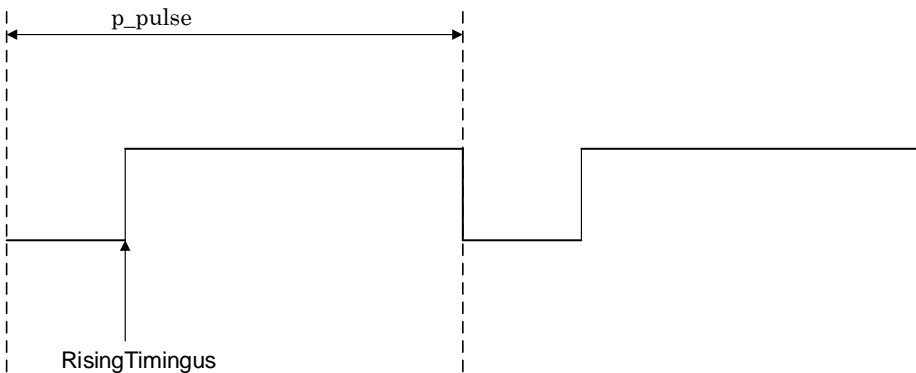

7.5. Output Example of Terminal Software

When the sample program is executed, the Duty ratio is displayed as follows;

```
PPG Output
Duty: 10%
Change to Duty: 25%
PPG Output
Duty: 25%
Change to Duty: 50%
PPG Output
Duty: 50%
Change to Duty: 75%
```

7.5.1. Setting Example of Terminal Software

The operation of the terminal software has been checked with the following settings.

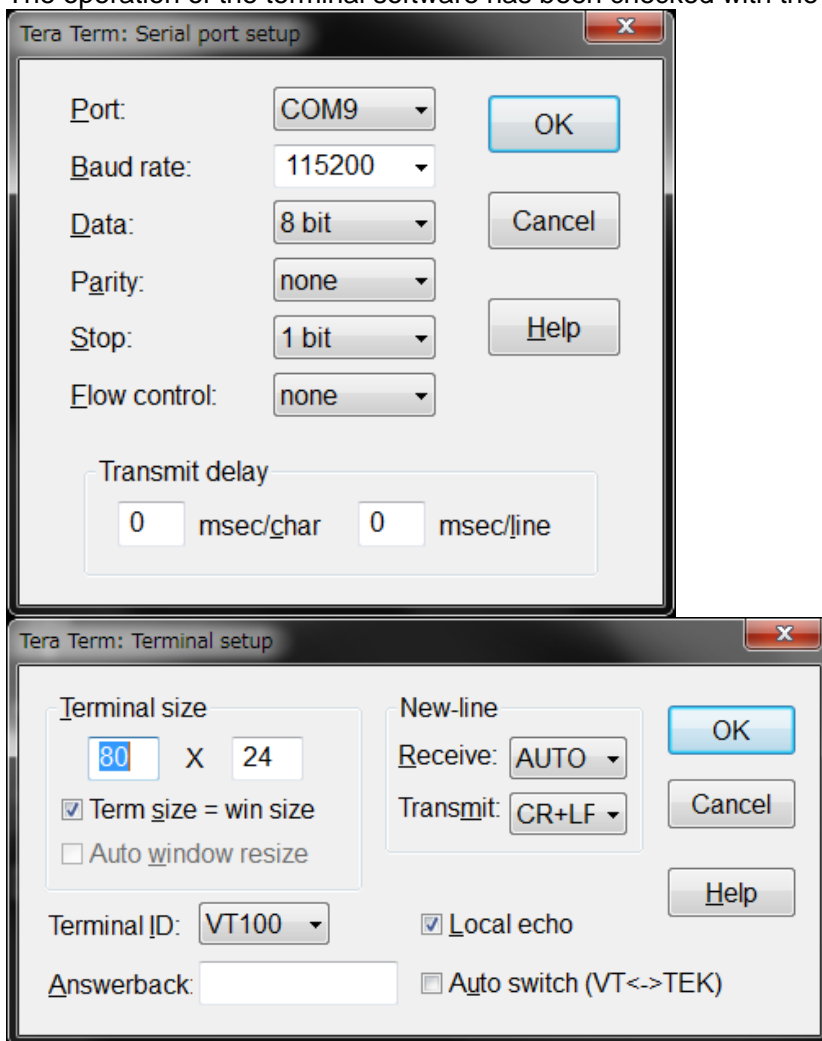

7.6. Operating Flow of Sample Program

The basic operating flows of the sample program are shown in the following;

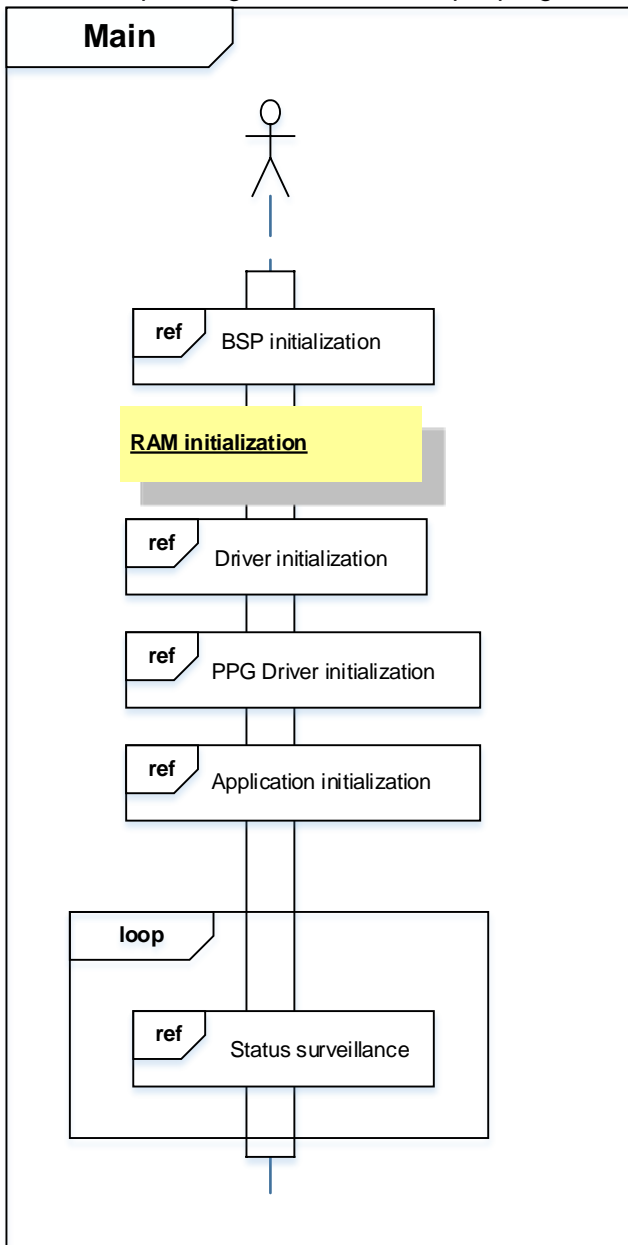

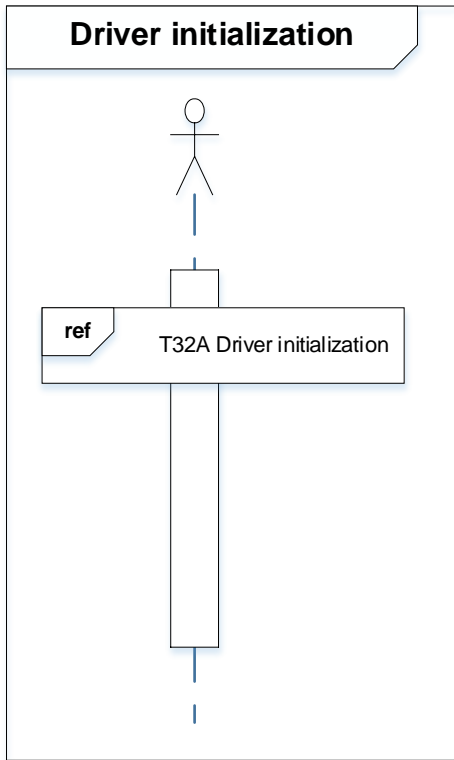

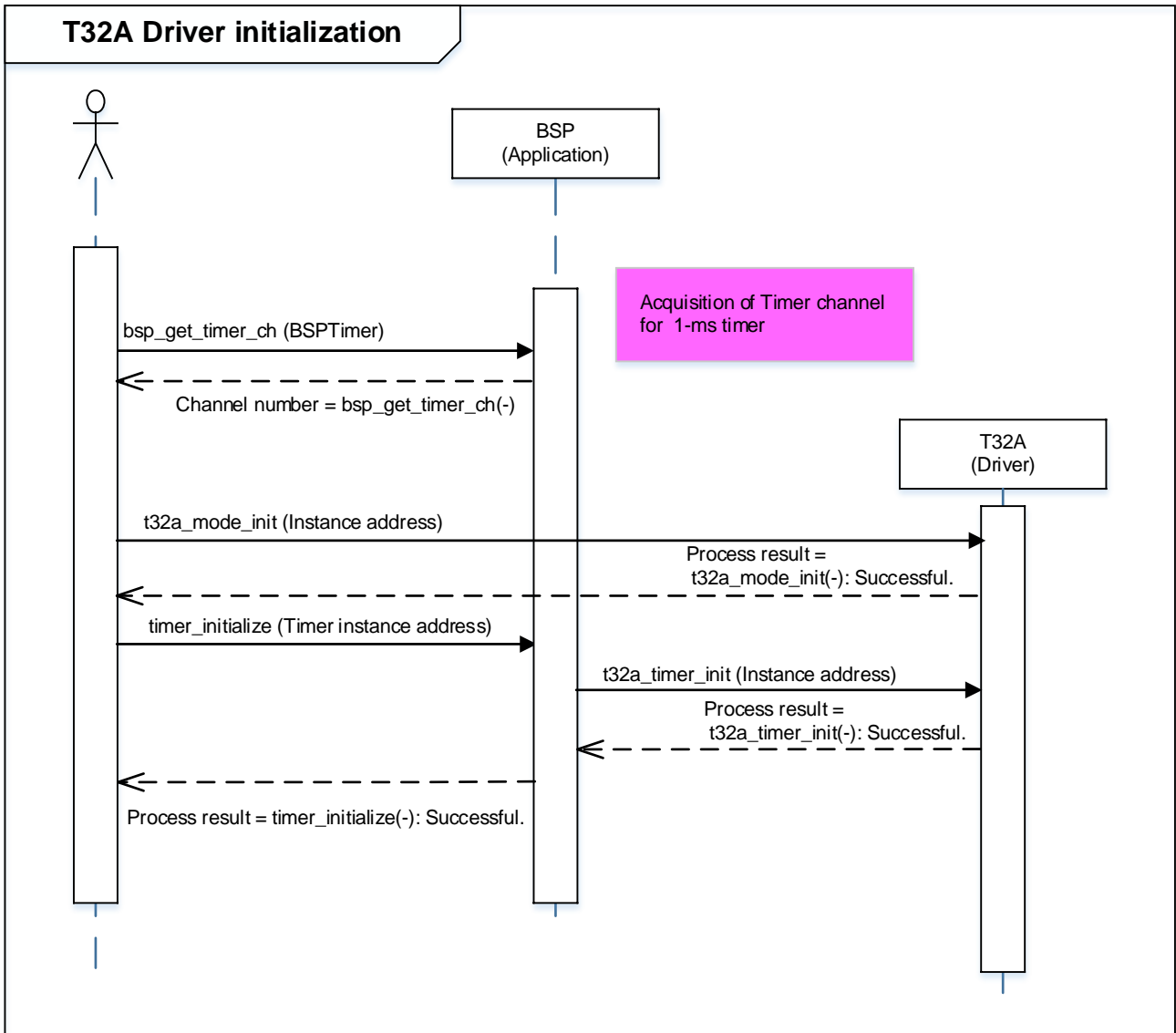

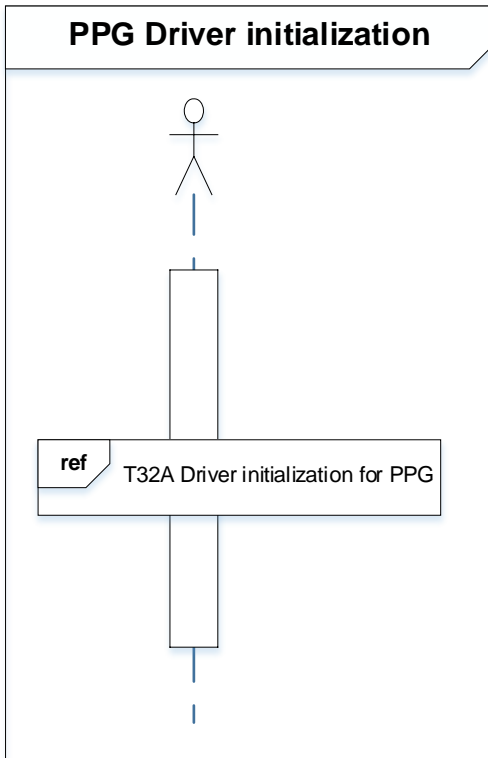

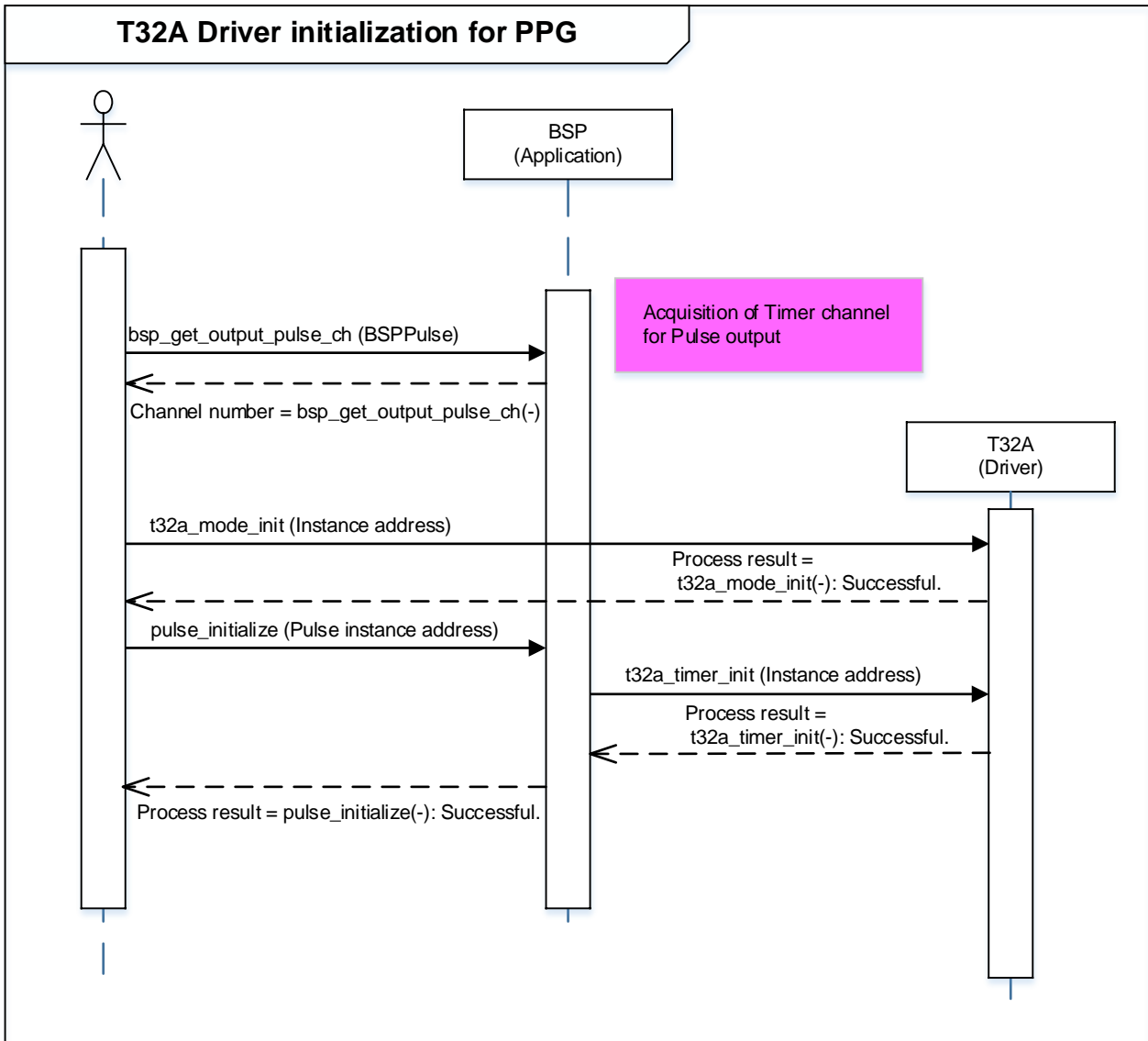

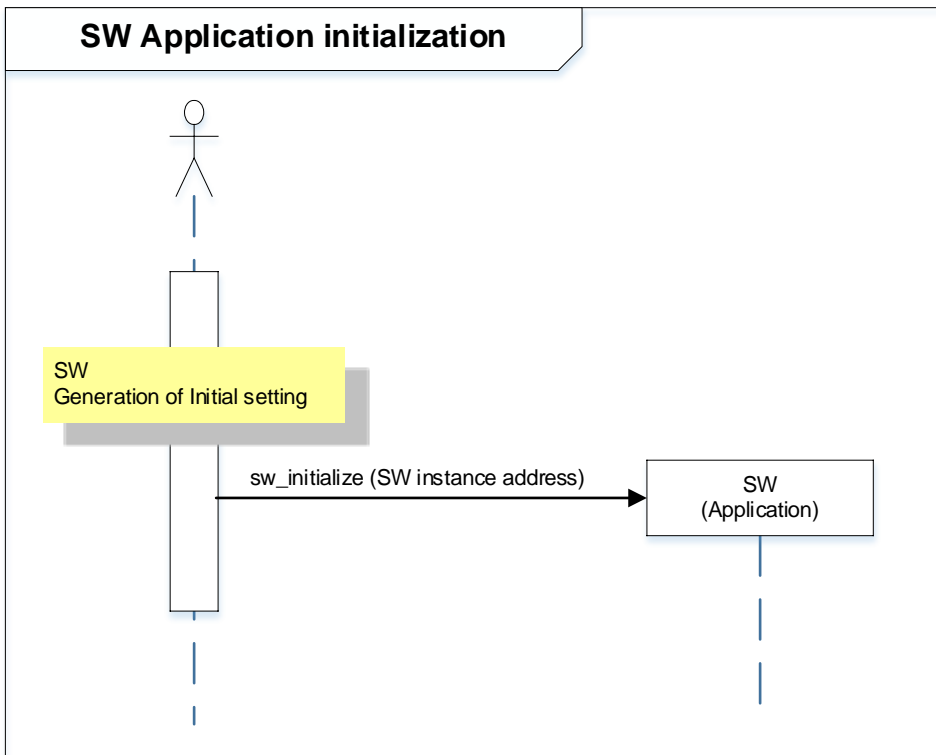
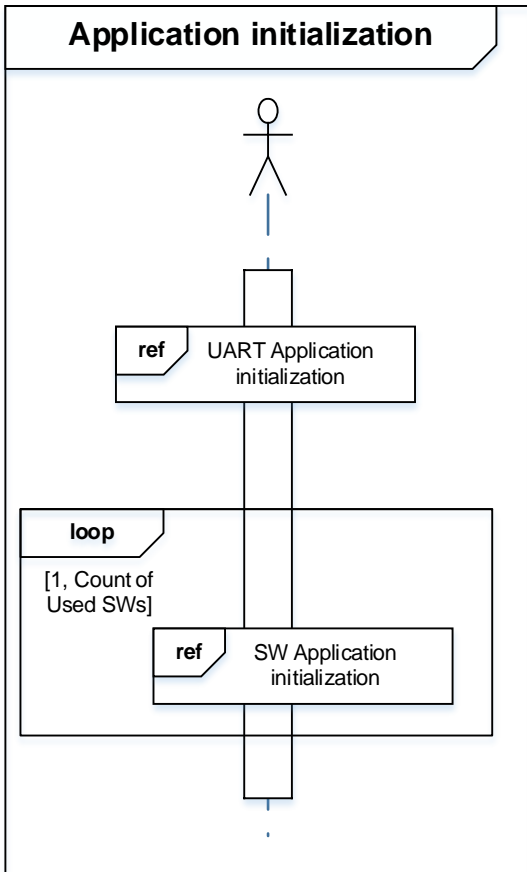

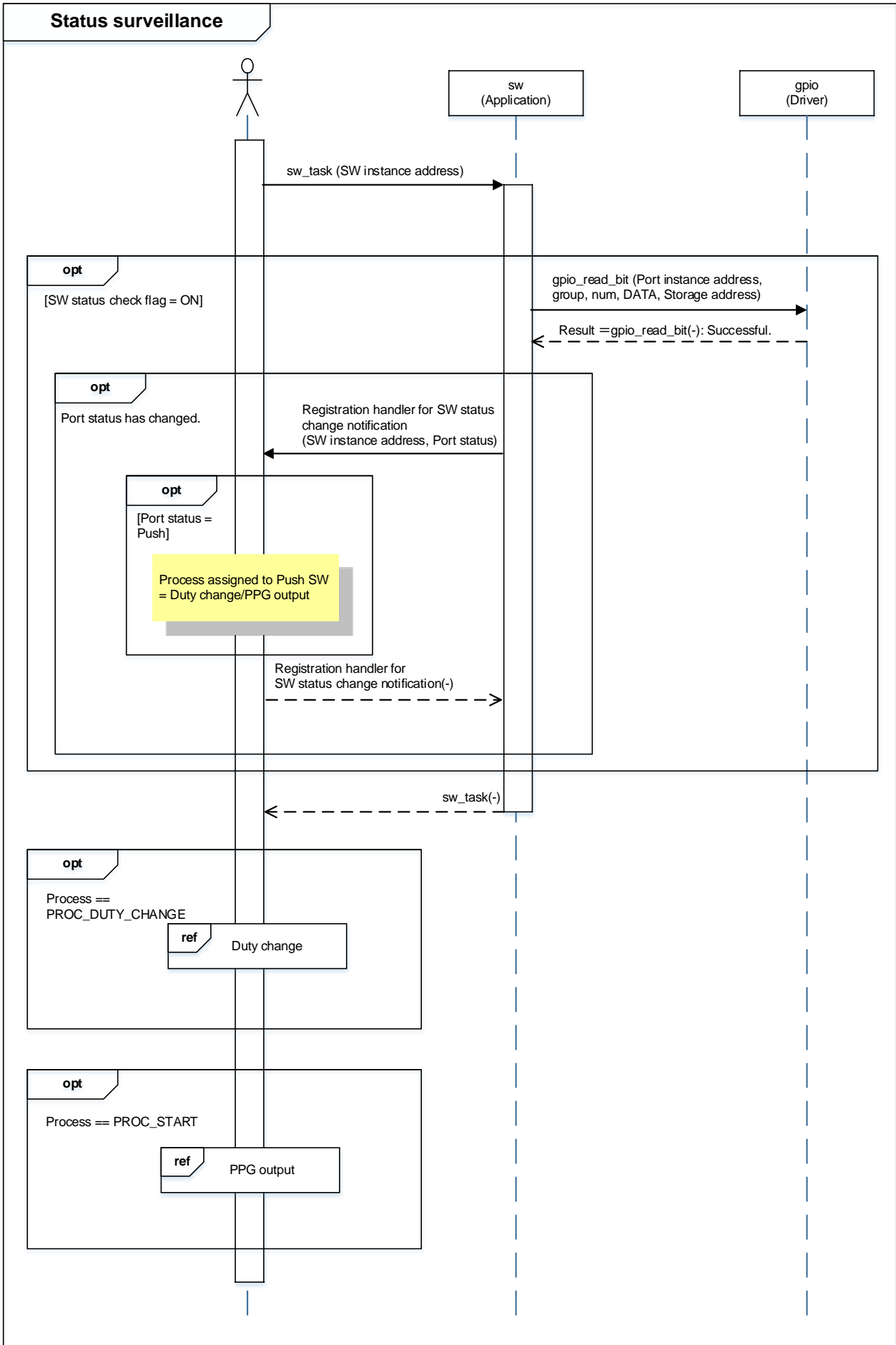

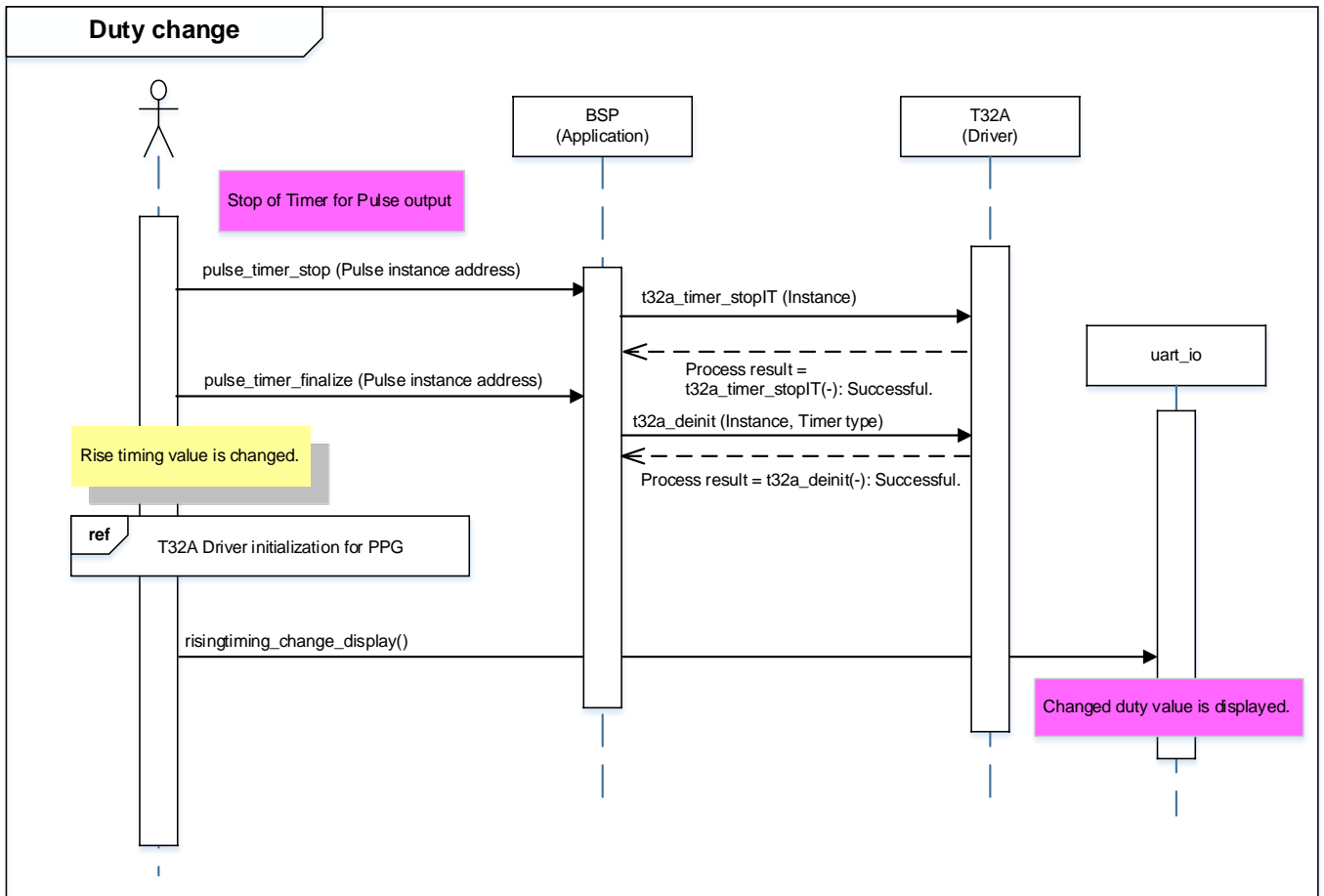

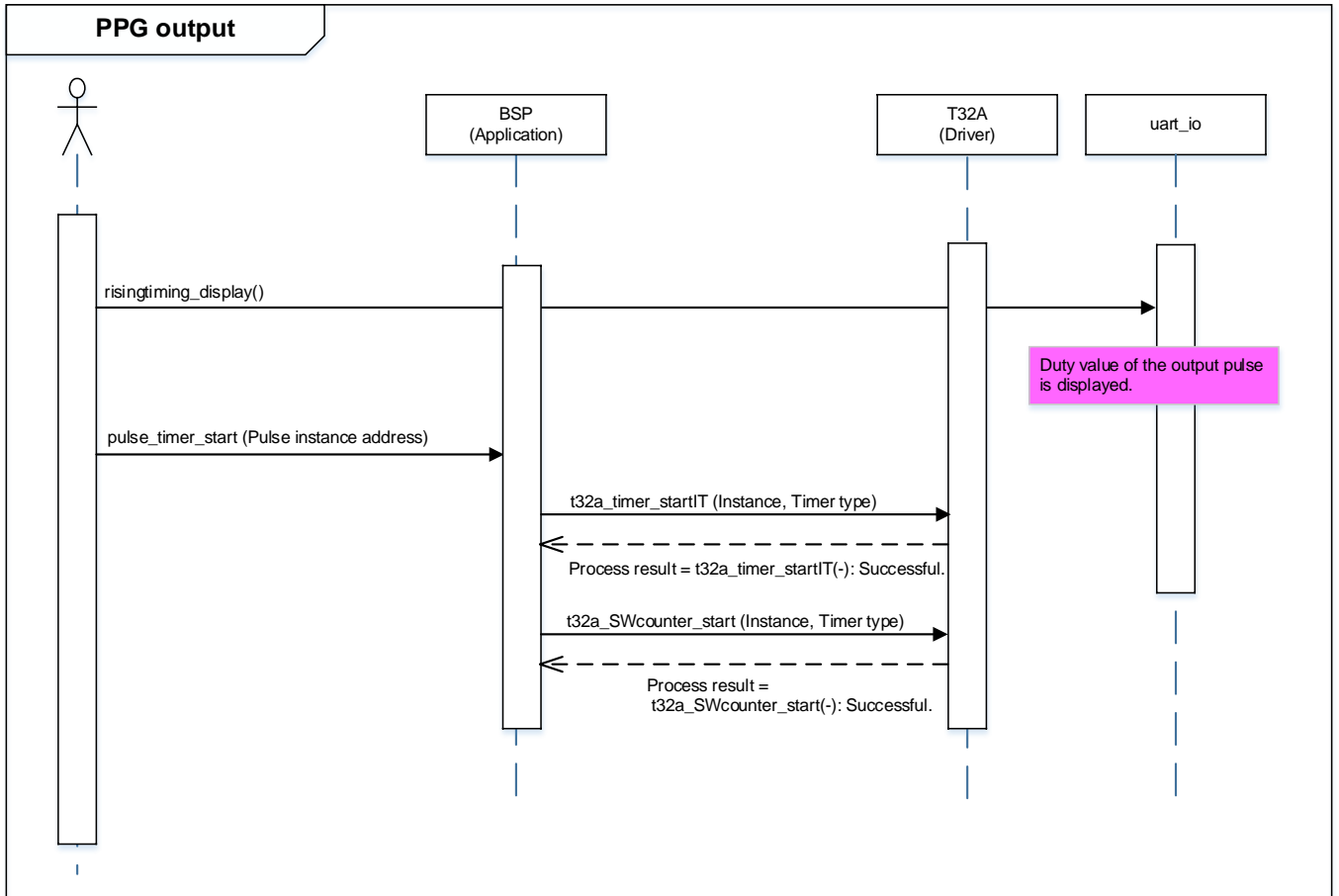

8. Points to Remember on Handling of Sample Programs

When using the sample program with other than “Operation Confirmation Condition”, please check the operation sufficiently.

9. Revision History

Revision	Date	Description
1.0	2019-10-21	First release

RESTRICTIONS ON PRODUCT USE

Toshiba Corporation and its subsidiaries and affiliates are collectively referred to as "TOSHIBA". Hardware, software and systems described in this document are collectively referred to as "Product".

- TOSHIBA reserves the right to make changes to the information in this document and related Product without notice.
- This document and any information herein may not be reproduced without prior written permission from TOSHIBA. Even with TOSHIBA's written permission, reproduction is permissible only if reproduction is without alteration/omission.
- Though TOSHIBA works continually to improve Product's quality and reliability, Product can malfunction or fail. Customers are responsible for complying with safety standards and for providing adequate designs and safeguards for their hardware, software and systems which minimize risk and avoid situations in which a malfunction or failure of Product could cause loss of human life, bodily injury or damage to property, including data loss or corruption. Before customers use the Product, create designs including the Product, or incorporate the Product into their own applications, customers must also refer to and comply with (a) the latest versions of all relevant TOSHIBA information, including without limitation, this document, the specifications, the data sheets and application notes for Product and the precautions and conditions set forth in the "TOSHIBA Semiconductor Reliability Handbook" and (b) the instructions for the application with which the Product will be used with or for. Customers are solely responsible for all aspects of their own product design or applications, including but not limited to (a) determining the appropriateness of the use of this Product in such design or applications; (b) evaluating and determining the applicability of any information contained in this document, or in charts, diagrams, programs, algorithms, sample application circuits, or any other referenced documents; and (c) validating all operating parameters for such designs and applications. **TOSHIBA ASSUMES NO LIABILITY FOR CUSTOMERS' PRODUCT DESIGN OR APPLICATIONS.**
- **PRODUCT IS NEITHER INTENDED NOR WARRANTED FOR USE IN EQUIPMENTS OR SYSTEMS THAT REQUIRE EXTRAORDINARILY HIGH LEVELS OF QUALITY AND/OR RELIABILITY, AND/OR A MALFUNCTION OR FAILURE OF WHICH MAY CAUSE LOSS OF HUMAN LIFE, BODILY INJURY, SERIOUS PROPERTY DAMAGE AND/OR SERIOUS PUBLIC IMPACT ("UNINTENDED USE").** Except for specific applications as expressly stated in this document, Unintended Use includes, without limitation, equipment used in nuclear facilities, equipment used in the aerospace industry, lifesaving and/or life supporting medical equipment, equipment used for automobiles, trains, ships and other transportation, traffic signaling equipment, equipment used to control combustions or explosions, safety devices, elevators and escalators, and devices related to power plant. **IF YOU USE PRODUCT FOR UNINTENDED USE, TOSHIBA ASSUMES NO LIABILITY FOR PRODUCT.** For details, please contact your TOSHIBA sales representative or contact us via our website.
- Do not disassemble, analyze, reverse-engineer, alter, modify, translate or copy Product, whether in whole or in part.
- Product shall not be used for or incorporated into any products or systems whose manufacture, use, or sale is prohibited under any applicable laws or regulations.
- The information contained herein is presented only as guidance for Product use. No responsibility is assumed by TOSHIBA for any infringement of patents or any other intellectual property rights of third parties that may result from the use of Product. No license to any intellectual property right is granted by this document, whether express or implied, by estoppel or otherwise.
- **ABSENT A WRITTEN SIGNED AGREEMENT, EXCEPT AS PROVIDED IN THE RELEVANT TERMS AND CONDITIONS OF SALE FOR PRODUCT, AND TO THE MAXIMUM EXTENT ALLOWABLE BY LAW, TOSHIBA (1) ASSUMES NO LIABILITY WHATSOEVER, INCLUDING WITHOUT LIMITATION, INDIRECT, CONSEQUENTIAL, SPECIAL, OR INCIDENTAL DAMAGES OR LOSS, INCLUDING WITHOUT LIMITATION, LOSS OF PROFITS, LOSS OF OPPORTUNITIES, BUSINESS INTERRUPTION AND LOSS OF DATA, AND (2) DISCLAIMS ANY AND ALL EXPRESS OR IMPLIED WARRANTIES AND CONDITIONS RELATED TO SALE, USE OF PRODUCT, OR INFORMATION, INCLUDING WARRANTIES OR CONDITIONS OF MERCHANTABILITY, FITNESS FOR A PARTICULAR PURPOSE, ACCURACY OF INFORMATION, OR NONINFRINGEMENT.**
- Do not use or otherwise make available Product or related software or technology for any military purposes, including without limitation, for the design, development, use, stockpiling or manufacturing of nuclear, chemical, or biological weapons or missile technology products (mass destruction weapons). Product and related software and technology may be controlled under the applicable export laws and regulations including, without limitation, the Japanese Foreign Exchange and Foreign Trade Law and the U.S. Export Administration Regulations. Export and re-export of Product or related software or technology are strictly prohibited except in compliance with all applicable export laws and regulations.
- Please contact your TOSHIBA sales representative for details as to environmental matters such as the RoHS compatibility of Product. Please use Product in compliance with all applicable laws and regulations that regulate the inclusion or use of controlled substances, including without limitation, the EU RoHS Directive. **TOSHIBA ASSUMES NO LIABILITY FOR DAMAGES OR LOSSES OCCURRING AS A RESULT OF NONCOMPLIANCE WITH APPLICABLE LAWS AND REGULATIONS.**

TOSHIBA ELECTRONIC DEVICES & STORAGE CORPORATION

<https://toshiba.semicon-storage.com/>