

M4K Group (1)
Application Note
Asynchronous Serial
Communication Circuit
(UART-C)
DMA

Outlines

This application note is a reference material for developing products using the Asynchronous serial communication circuit (UART with DMA) function of M4K Group (1).
This document helps the user check operation of the product and develop its program.

Target sample program: UART Echo DMA

Table of Contents

Outlines	1
Table of Contents	2
1. Preface	4
2. Reference Document	4
3. Function to Use	4
4. Target Device	4
5. Operation Confirmation Condition	5
6. Evaluation Board Operation	5
7. Sample Program	6
7.1. Structure Diagram of Sample Program	6
7.2. Startup Routine	6
7.3. Main Operation	6
7.4. Output Example of Terminal Software	7
7.4.1. Setting Example of Terminal Software	7
7.5. Operating Flow of Sample Program	8
8. Points to Remember on Handling of Sample Programs	21
9. Revision History	21
RESTRICTIONS ON PRODUCT USE	22

Arm and Keil are registered trademarks of Arm Limited (or its subsidiaries) in the US and/or elsewhere.

All other company names, product names, and service names mentioned herein may be trademarks of their respective companies.

1. Preface

This sample program is use to check the operation of the UART communication function using the DMA. Data input from the terminal software on a PC is stored to the memory via the USB-UART interface. The data stored in the memory is transferred and echoed back by the DMAC control.

2. Reference Document

1. Datasheet
 TPM4K Group (1) datasheet Rev2.0 (Japanese edition)
2. Reference manual
 Asynchronous Serial Communication Circuit (UART-C) Rev3.0 (Japanese edition)
 DMA Controller (DMAC-B) Rev2.0 (Japanese edition)
3. Application note
 M4K Group (1) Application Note Startup (CMSIS System & Clock Configuration) Rev1.0
4. Other reference document
 TPM4KxA Group Peripheral Driver User Manual (Doxygen) V1.0.4.0

3. Function to Use

IP	Channel	Port	Function/Operation mode
Asynchronous Serial Communication Circuit	ch0	PK0 (UT0RXD) PK1 (UT0TXDA)	UART mode
DMA Controller	ch8 ch9	—	Unit normal transfer

4. Target Device

The target devices of this application note are as follows;

TMPM4K4FYAUG	TMPM4K4FWAUG	TMPM4K4FUAUG	TMPM4K4FSAUG
TMPM4K4FYAFG	TMPM4K4FWAFG	TMPM4K4FUAFG	TMPM4K4FSAFG
TMPM4K2FYADUG	TMPM4K2FWADUG	TMPM4K2FUADUG	TMPM4K2FSADUG
TMPM4K1FYAUG	TMPM4K1FWAUG	TMPM4K1FUAUG	TMPM4K1FSAUG
			TMPM4K0FSADUG

* This sample program operates on the evaluation board of TMPM4K4FYAUG.

If other function than the TMPM4K4 one is checked, it is necessary that CMSIS Core related files (the startup file and I/O header file) should be changed properly.

Additionally, the name of microcontroller which is set to the project should be changed.

The BSP related file is dedicated to the evaluation board (TMPM4K4FYAUG). If other function than the TMPM4K4 one is checked, the BSP related file should be changed properly.

5. Operation Confirmation Condition

Used microcontroller	TMPM4K4FYAUG
Used board	TMPM4K4 evaluation board (Product of ESP-kikaku Co. Ltd.)
Integrated development environment	IAR Embedded Workbench for ARM 8.22.2
Integrated development environment	Arm® Keil® MDK Version 5.24.2.0
Terminal software	Tera Term V4.96
Sample program	v1.0.0

6. Evaluation Board Operation

A PC should be connected with the USB_UART connector to communicate with the terminal software. When a character is input to the terminal software, the input character is echoed back to the terminal software.

7. Sample Program

7.1. Structure Diagram of Sample Program

The structure diagram of the sample program is shown below.

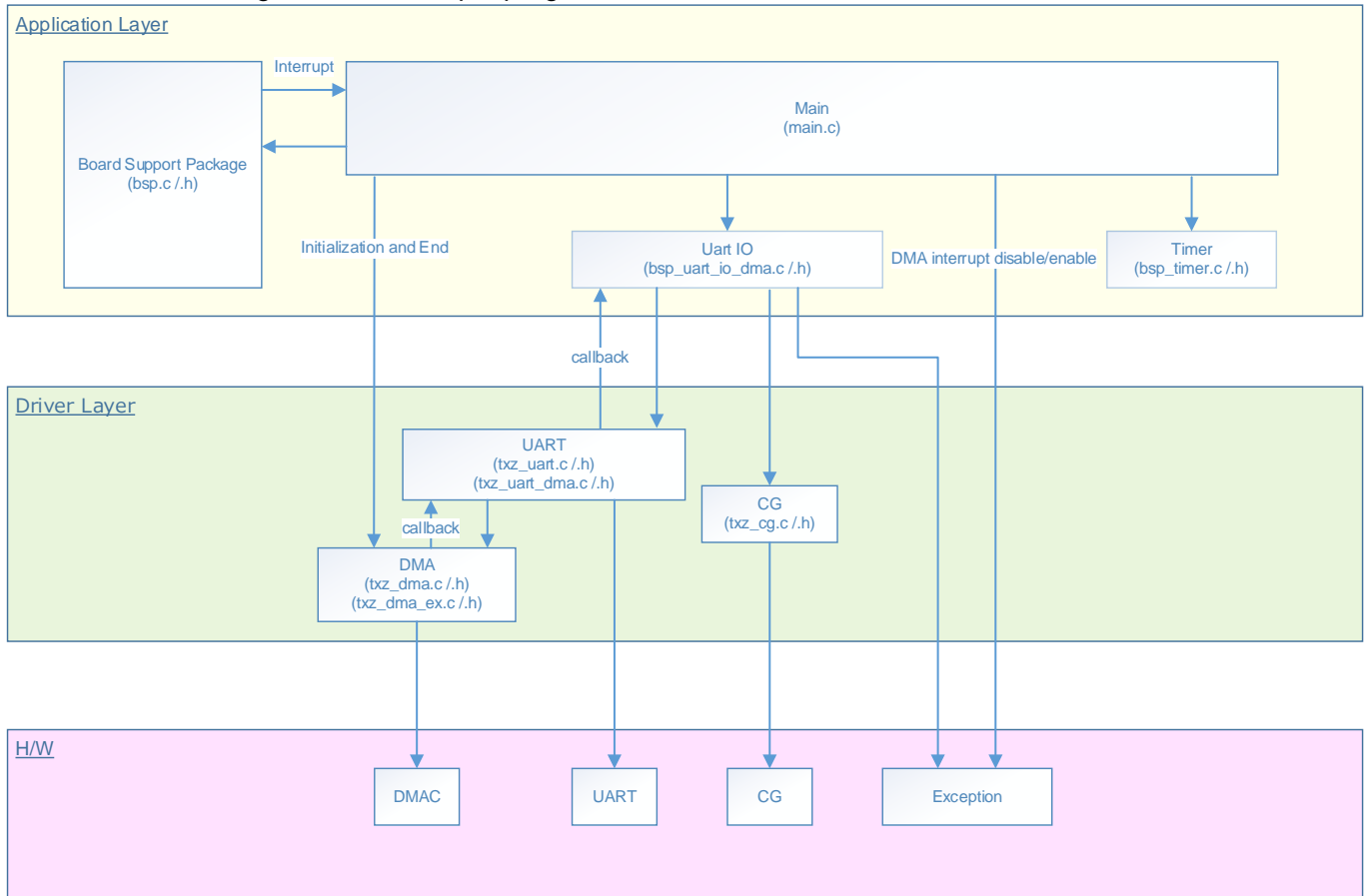

7.2. Startup Routine

The following initialization is done after power is supplied.

The initialization of each clock setting and the initialization of the watchdog timer setting are done.

7.3. Main Operation

The initialization of the BSP should be done.

The initialization of the variables should be done.

The initialization of the T32A driver and the initialization of the DMA driver should be done as the initialization of the drivers.

The initialization of the Timer and the initialization of the USB_UART should be done as the initialization of the application software.

The interrupt of the DMA should be enabled.

The Timer is started.

"Input =" is displayed on the terminal software on the PC. The sample program waits for an input.

When a line feed code is detected, an input character is displayed after "Echo =" as the echo-back character.

After that, the sample program waits for an input. The operations above repeat.

The DMA is used for the data transmission and reception.

The reception is done as a single transmission. The transmission is done as a burst transmission.

The maximum size of the input data is 32 bytes.

When the size of the input characters exceeds the maximum value, "Input Error !!" is displayed.

7.4. Output Example of Terminal Software

When the sample program is executed, the command result is displayed as follows;

```

Input = 012345
Echo = 012345
Input = 012345678901234567890123456789
Echo = 012345678901234567890123456789
Input = 01234567890123456789012345678901

Input Error !!
Input = Echo =
Input =
    
```

7.4.1. Setting Example of Terminal Software

The operation of the terminal software has been checked with the following settings.

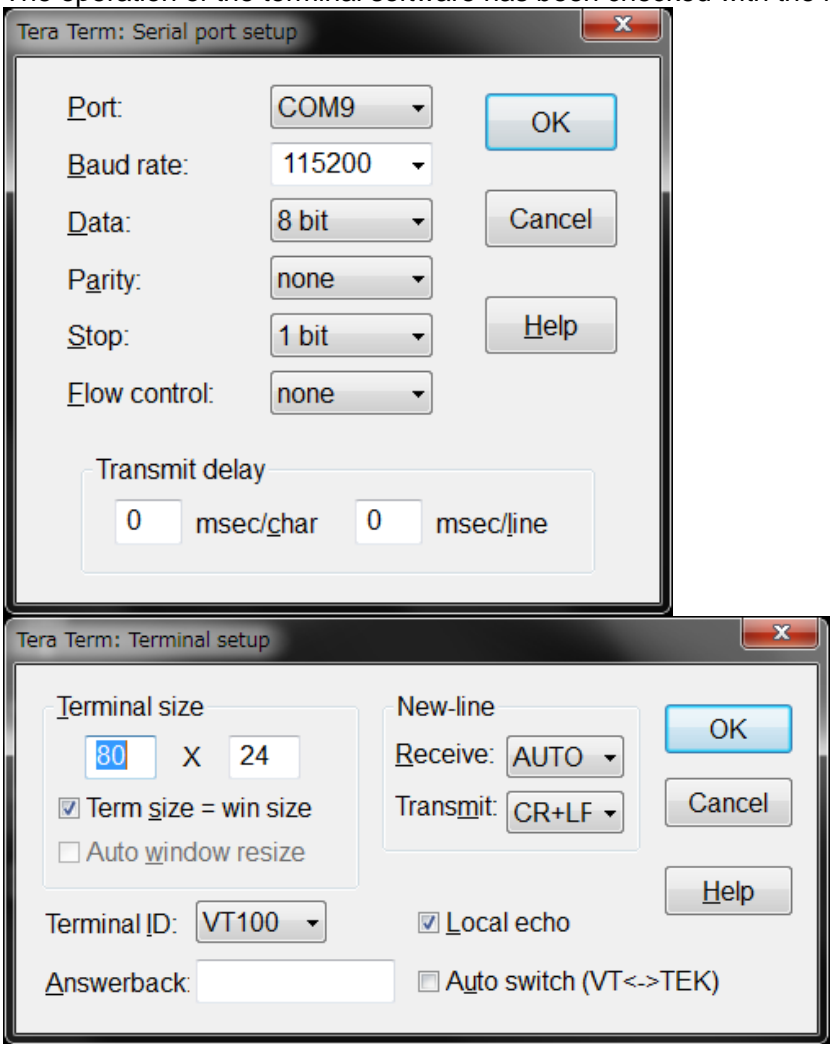

7.5. Operating Flow of Sample Program

The basic operating flows of the sample program are shown in the following;

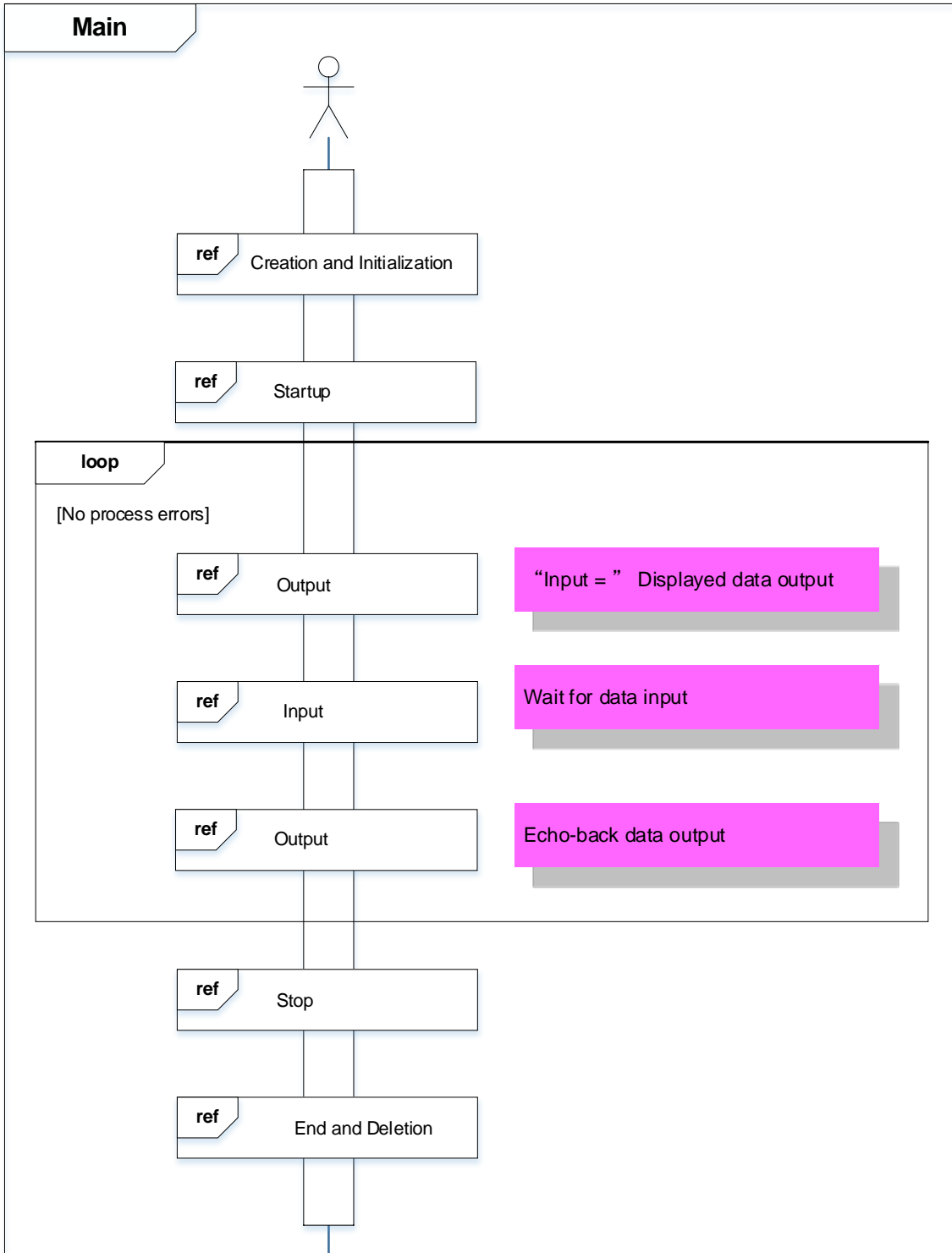

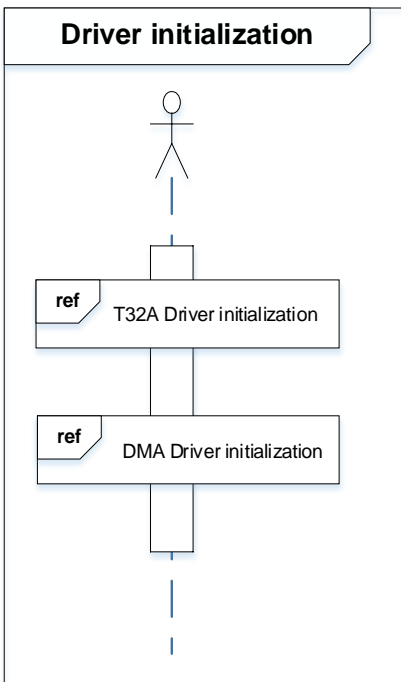
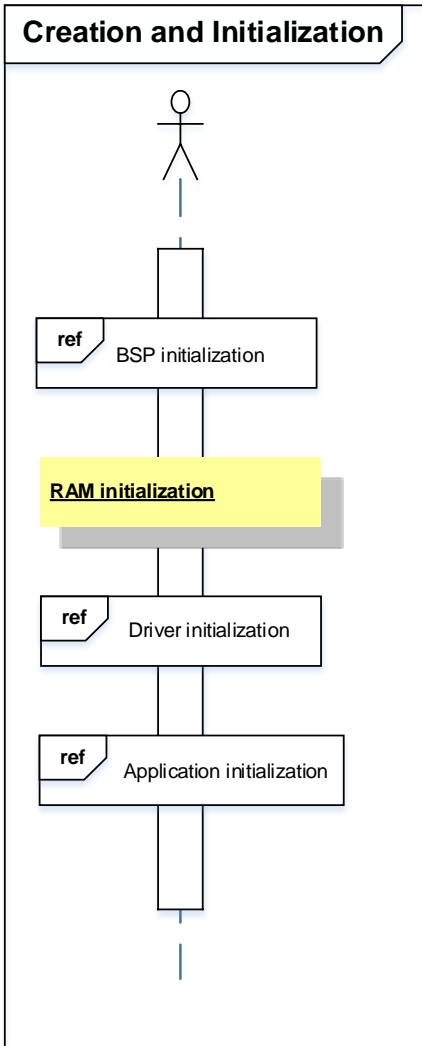

The 32-bit timer event counter of TPM4K4A is running, but processing using timer count is not performed.

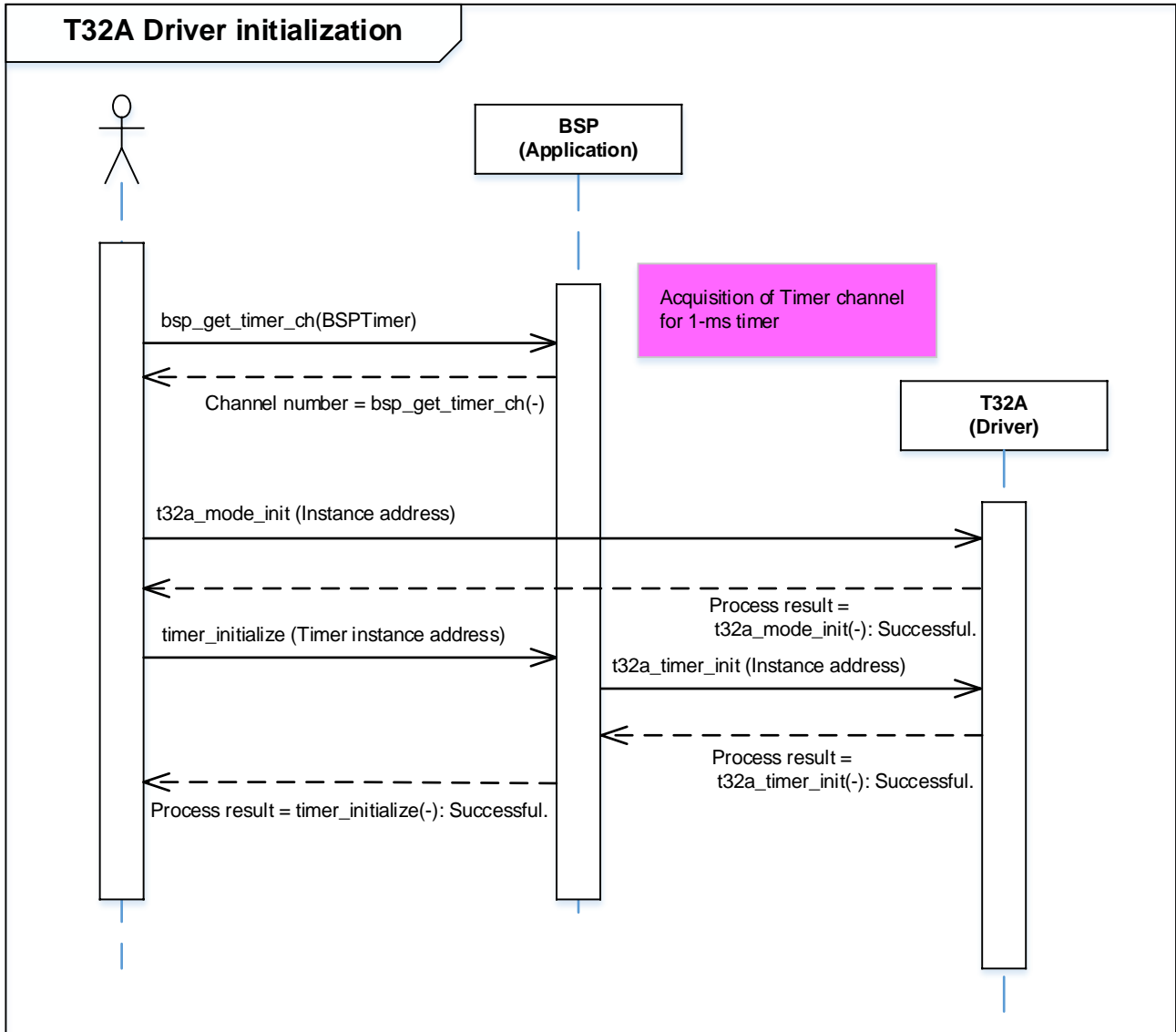

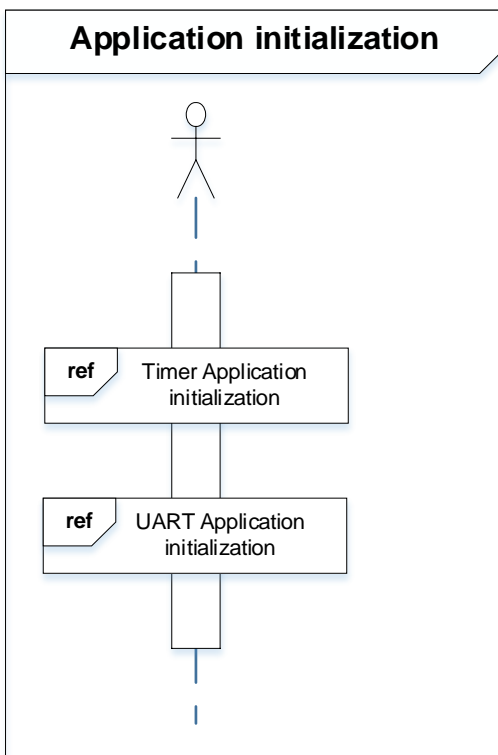
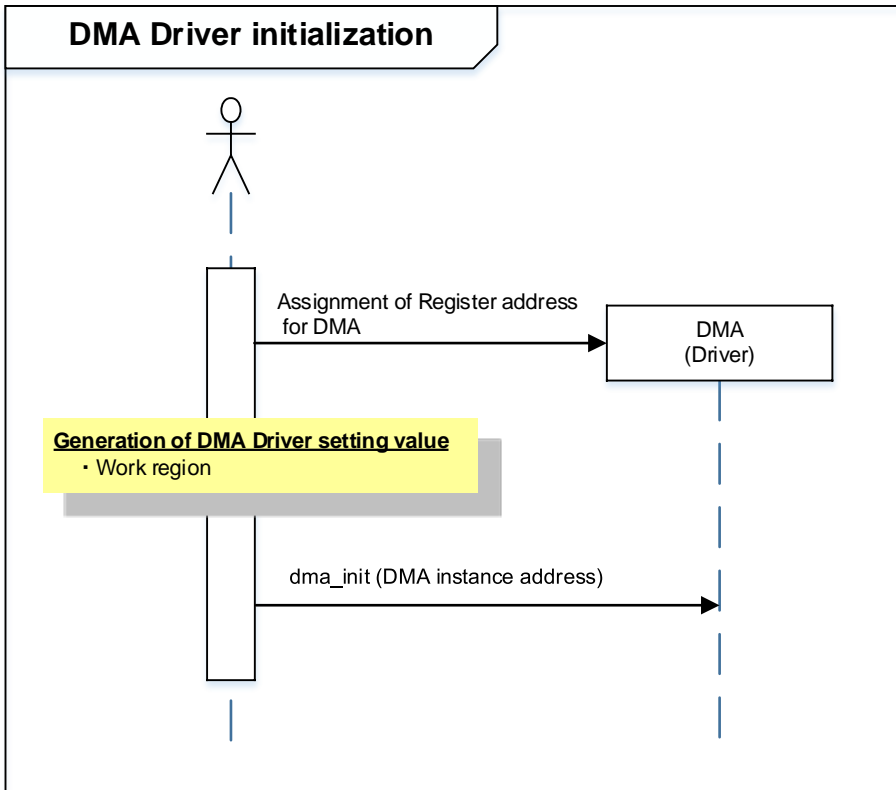

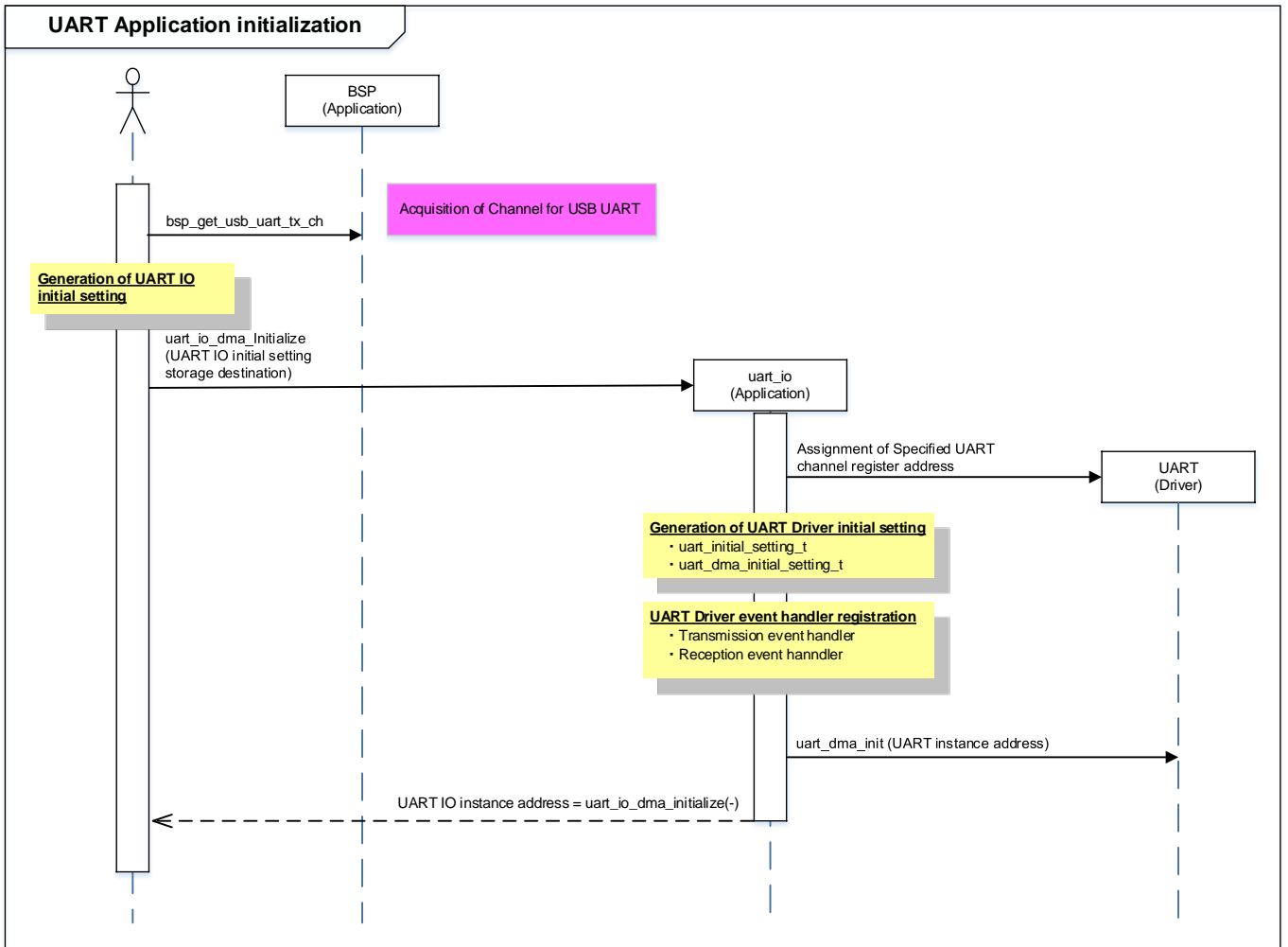

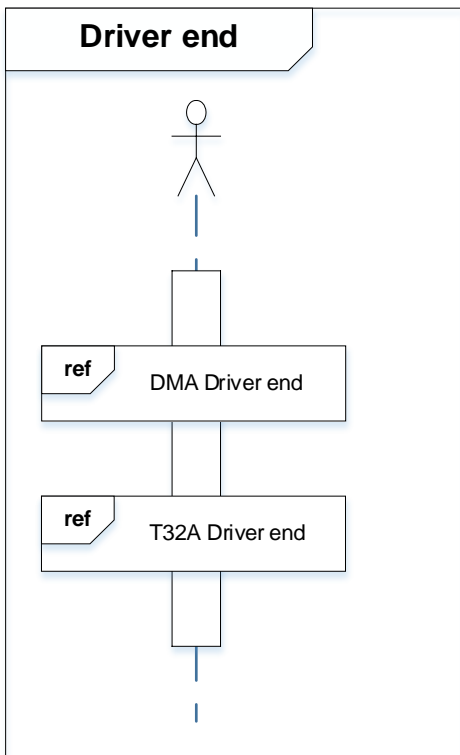
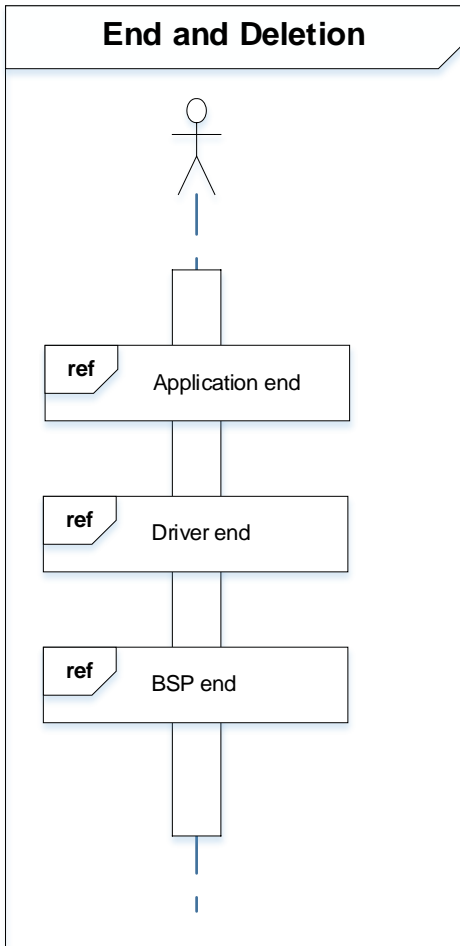

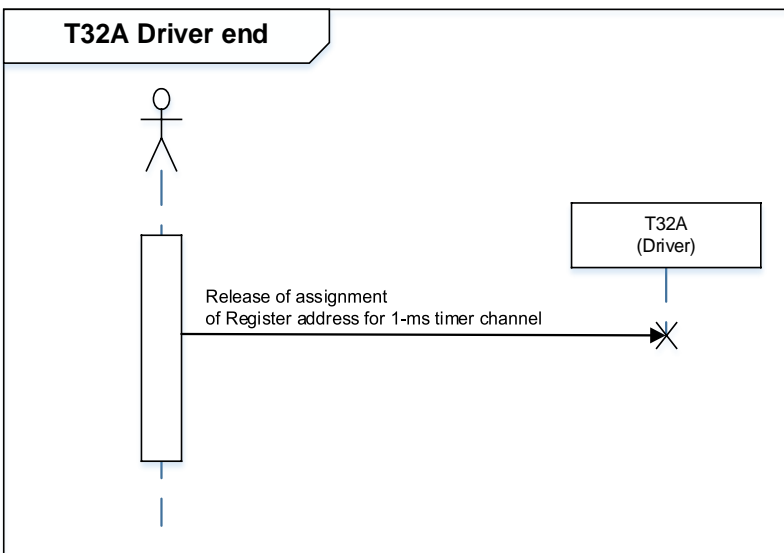
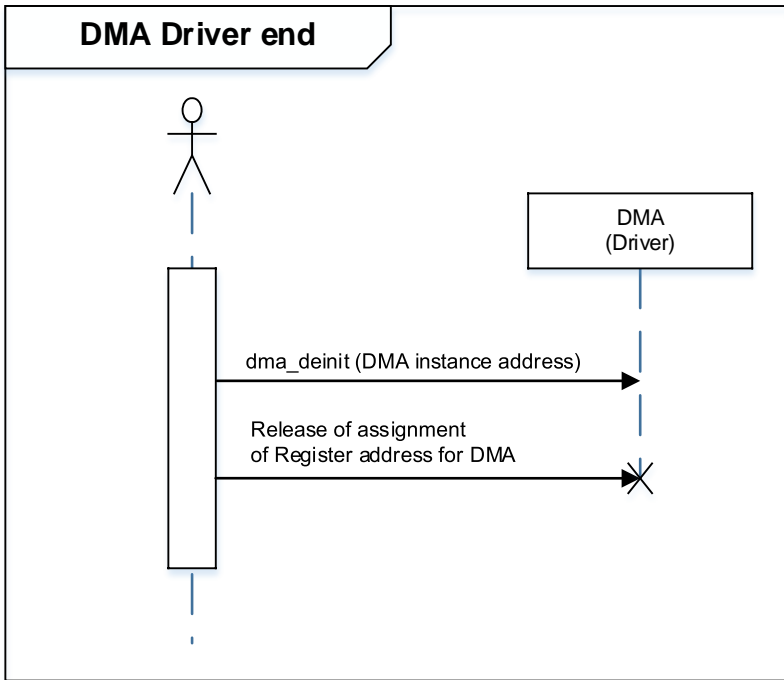

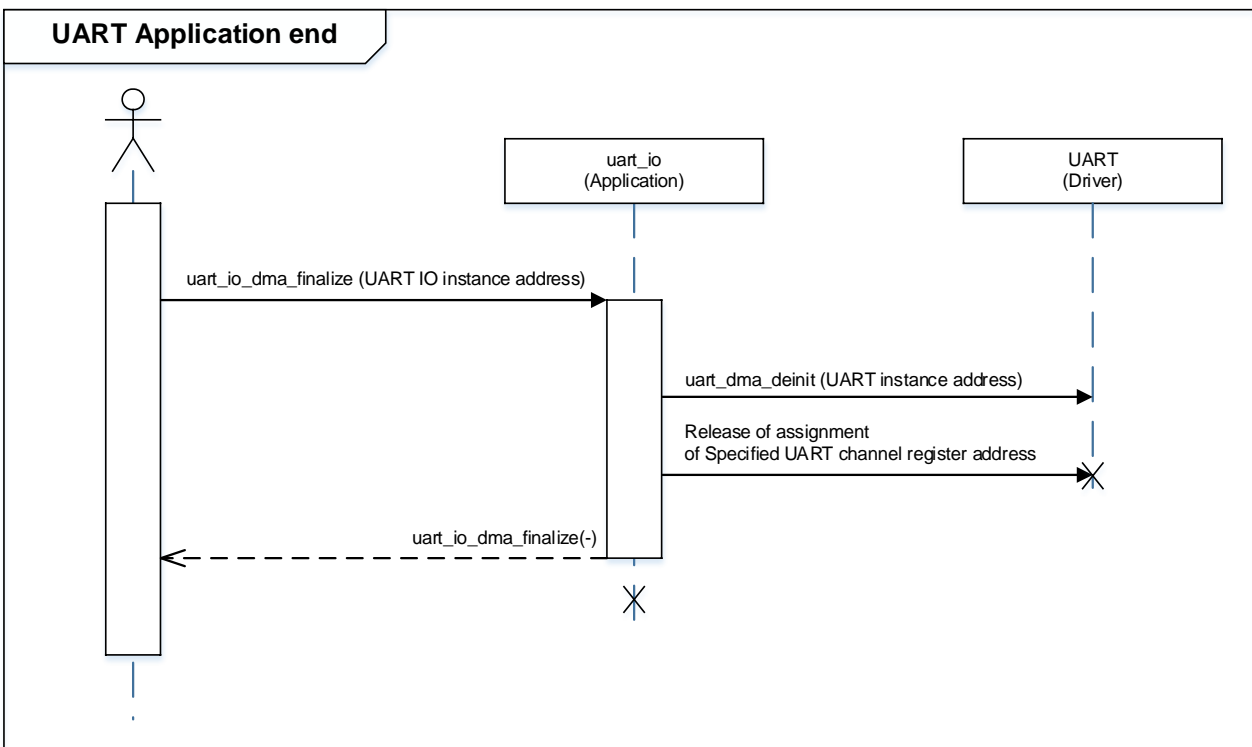
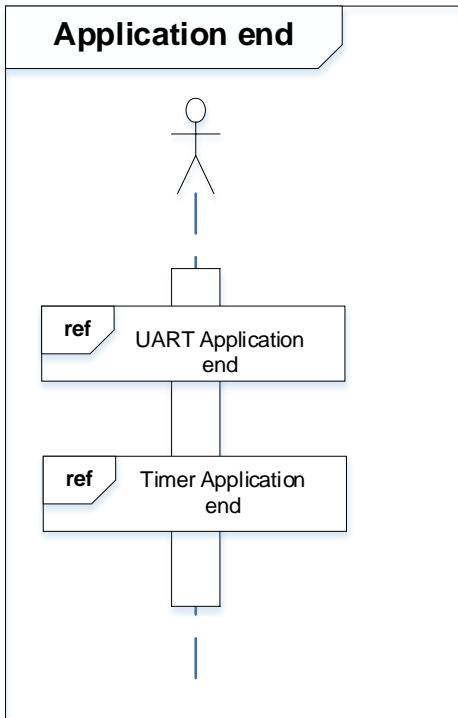

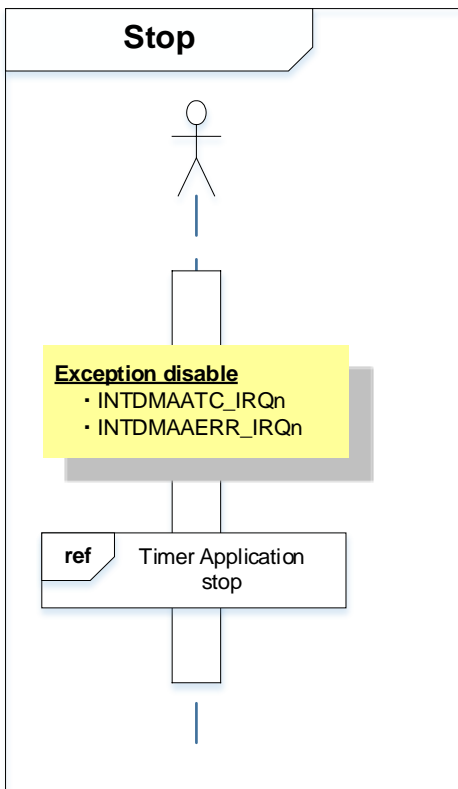
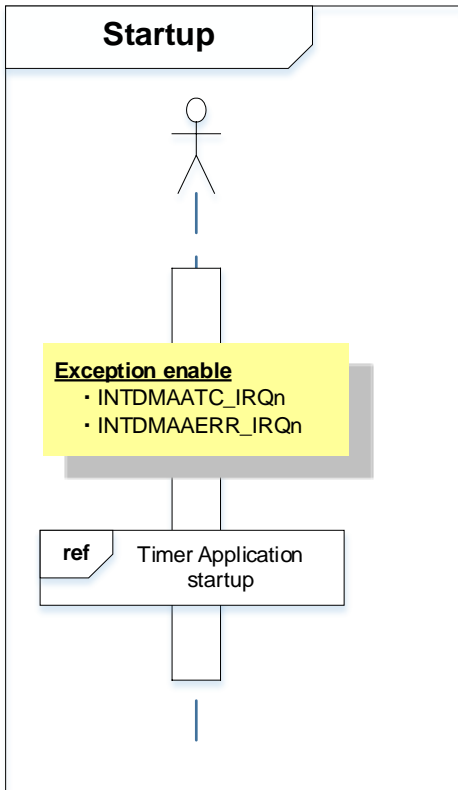

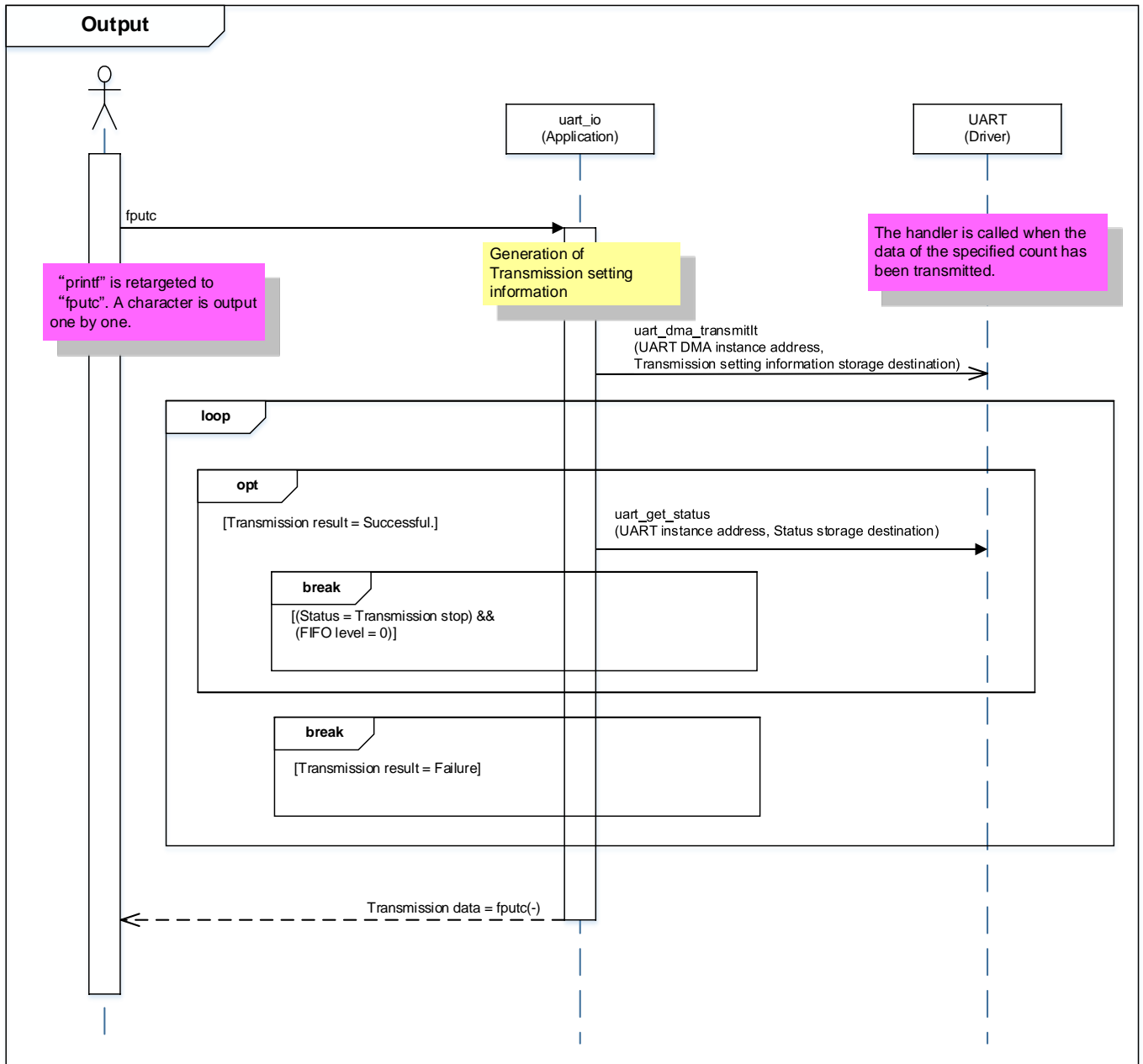

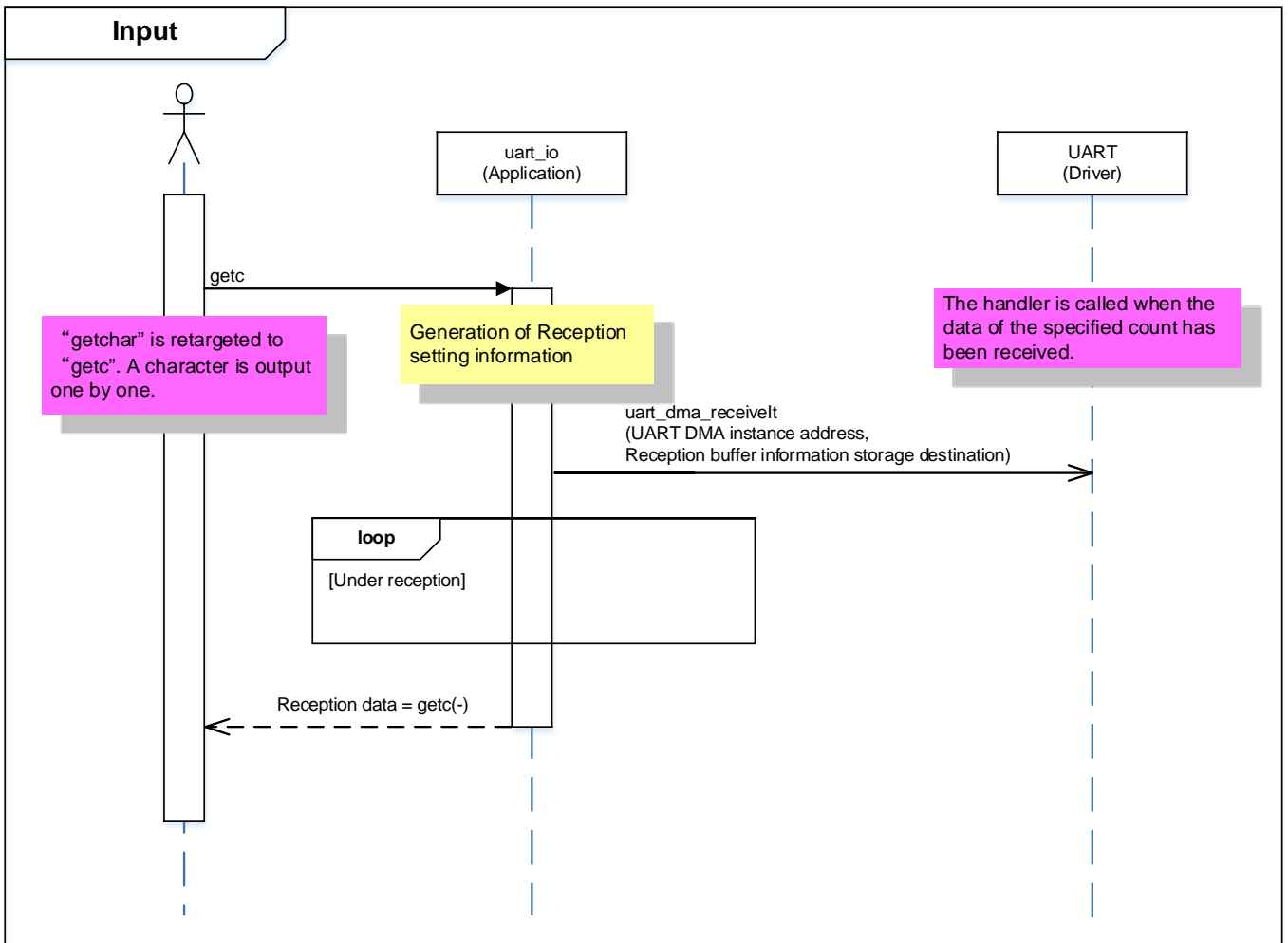

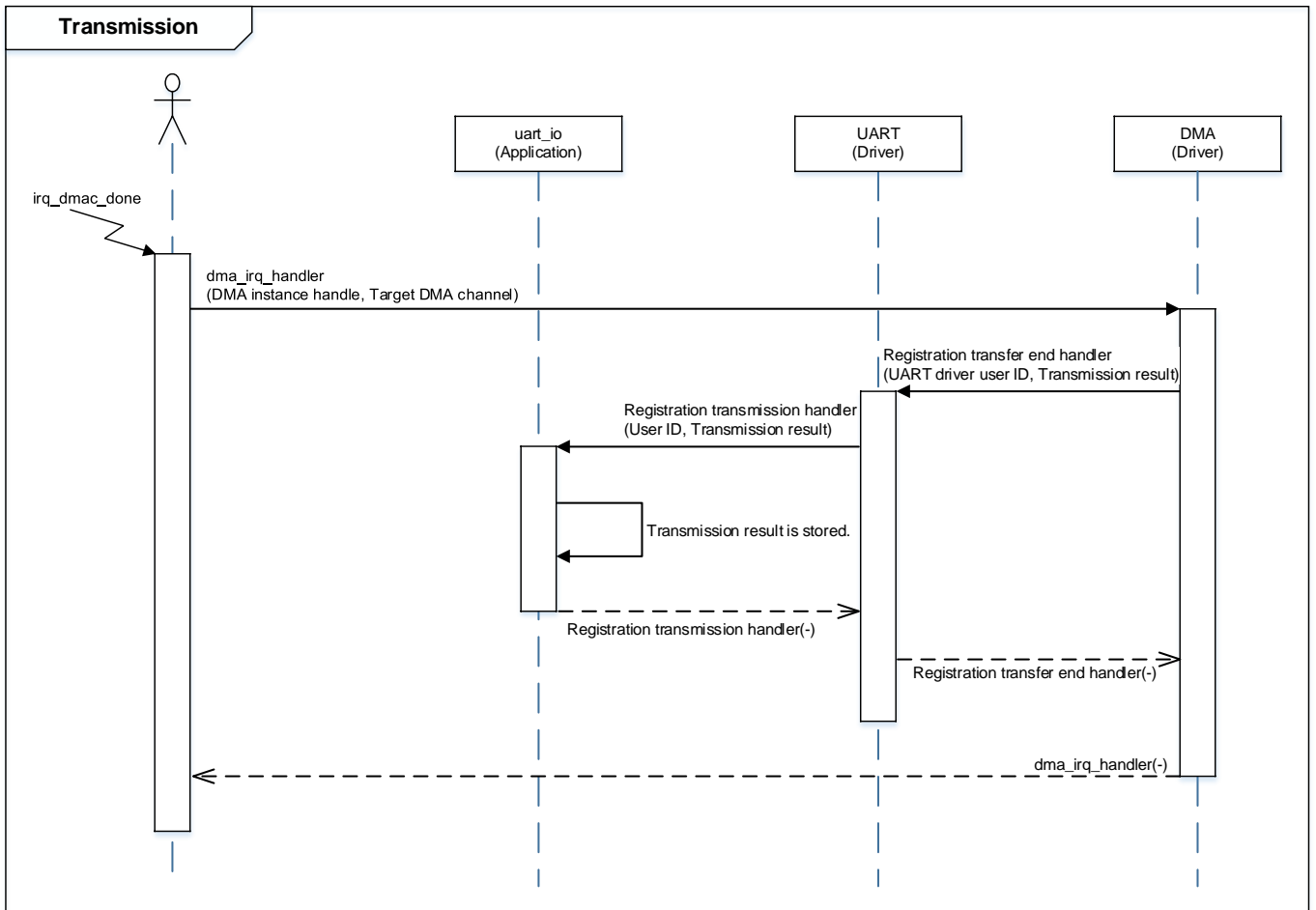

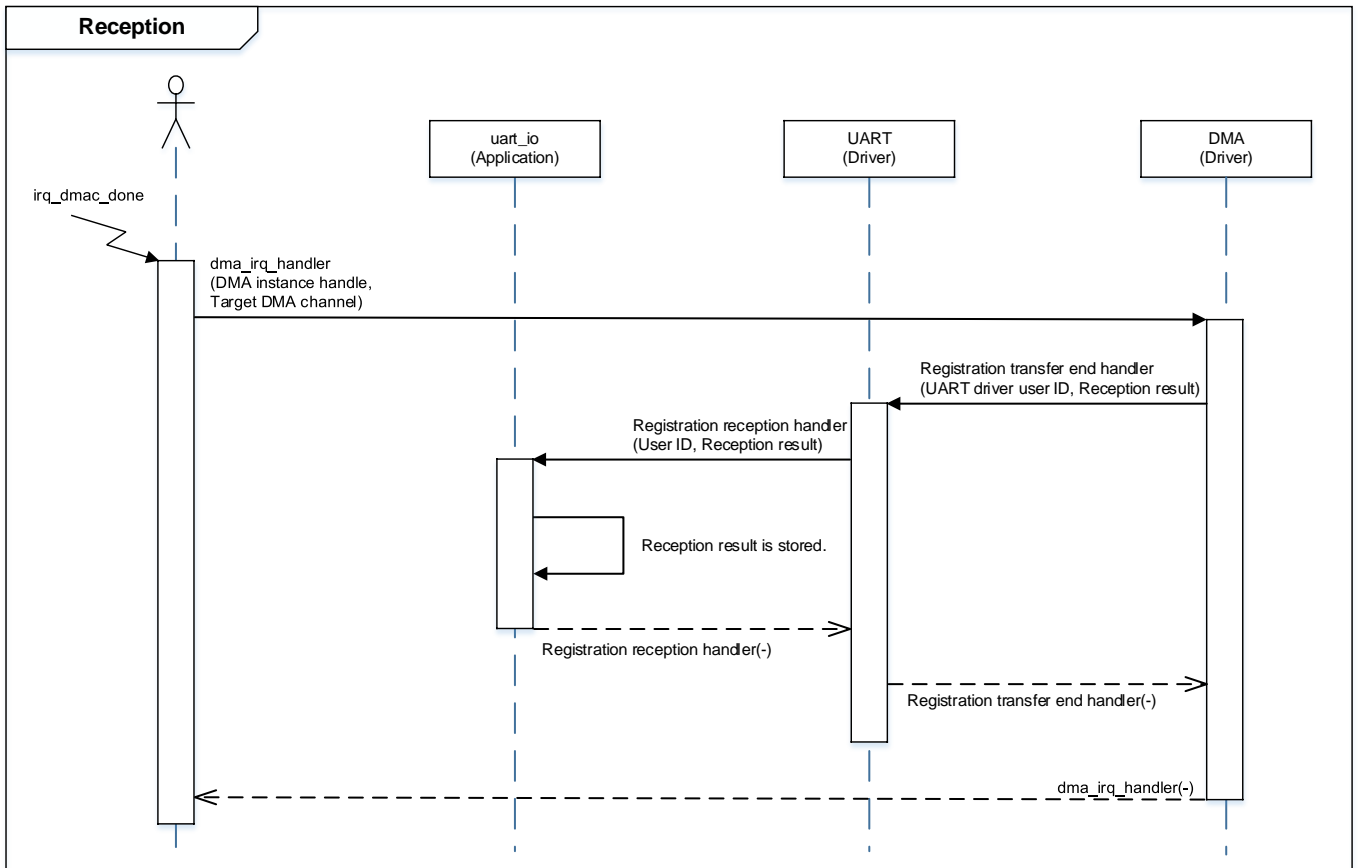

8. Points to Remember on Handling of Sample Programs

When using the sample program with other than “Operation Confirmation Condition”, please check the operation sufficiently.

9. Revision History

Revision	Date	Description
1.0	2019-10-21	First release

RESTRICTIONS ON PRODUCT USE

Toshiba Corporation and its subsidiaries and affiliates are collectively referred to as "TOSHIBA". Hardware, software and systems described in this document are collectively referred to as "Product".

- TOSHIBA reserves the right to make changes to the information in this document and related Product without notice.
- This document and any information herein may not be reproduced without prior written permission from TOSHIBA. Even with TOSHIBA's written permission, reproduction is permissible only if reproduction is without alteration/omission.
- Though TOSHIBA works continually to improve Product's quality and reliability, Product can malfunction or fail. Customers are responsible for complying with safety standards and for providing adequate designs and safeguards for their hardware, software and systems which minimize risk and avoid situations in which a malfunction or failure of Product could cause loss of human life, bodily injury or damage to property, including data loss or corruption. Before customers use the Product, create designs including the Product, or incorporate the Product into their own applications, customers must also refer to and comply with (a) the latest versions of all relevant TOSHIBA information, including without limitation, this document, the specifications, the data sheets and application notes for Product and the precautions and conditions set forth in the "TOSHIBA Semiconductor Reliability Handbook" and (b) the instructions for the application with which the Product will be used with or for. Customers are solely responsible for all aspects of their own product design or applications, including but not limited to (a) determining the appropriateness of the use of this Product in such design or applications; (b) evaluating and determining the applicability of any information contained in this document, or in charts, diagrams, programs, algorithms, sample application circuits, or any other referenced documents; and (c) validating all operating parameters for such designs and applications. **TOSHIBA ASSUMES NO LIABILITY FOR CUSTOMERS' PRODUCT DESIGN OR APPLICATIONS.**
- **PRODUCT IS NEITHER INTENDED NOR WARRANTED FOR USE IN EQUIPMENTS OR SYSTEMS THAT REQUIRE EXTRAORDINARILY HIGH LEVELS OF QUALITY AND/OR RELIABILITY, AND/OR A MALFUNCTION OR FAILURE OF WHICH MAY CAUSE LOSS OF HUMAN LIFE, BODILY INJURY, SERIOUS PROPERTY DAMAGE AND/OR SERIOUS PUBLIC IMPACT ("UNINTENDED USE").** Except for specific applications as expressly stated in this document, Unintended Use includes, without limitation, equipment used in nuclear facilities, equipment used in the aerospace industry, lifesaving and/or life supporting medical equipment, equipment used for automobiles, trains, ships and other transportation, traffic signaling equipment, equipment used to control combustions or explosions, safety devices, elevators and escalators, and devices related to power plant. **IF YOU USE PRODUCT FOR UNINTENDED USE, TOSHIBA ASSUMES NO LIABILITY FOR PRODUCT.** For details, please contact your TOSHIBA sales representative or contact us via our website.
- Do not disassemble, analyze, reverse-engineer, alter, modify, translate or copy Product, whether in whole or in part.
- Product shall not be used for or incorporated into any products or systems whose manufacture, use, or sale is prohibited under any applicable laws or regulations.
- The information contained herein is presented only as guidance for Product use. No responsibility is assumed by TOSHIBA for any infringement of patents or any other intellectual property rights of third parties that may result from the use of Product. No license to any intellectual property right is granted by this document, whether express or implied, by estoppel or otherwise.
- **ABSENT A WRITTEN SIGNED AGREEMENT, EXCEPT AS PROVIDED IN THE RELEVANT TERMS AND CONDITIONS OF SALE FOR PRODUCT, AND TO THE MAXIMUM EXTENT ALLOWABLE BY LAW, TOSHIBA (1) ASSUMES NO LIABILITY WHATSOEVER, INCLUDING WITHOUT LIMITATION, INDIRECT, CONSEQUENTIAL, SPECIAL, OR INCIDENTAL DAMAGES OR LOSS, INCLUDING WITHOUT LIMITATION, LOSS OF PROFITS, LOSS OF OPPORTUNITIES, BUSINESS INTERRUPTION AND LOSS OF DATA, AND (2) DISCLAIMS ANY AND ALL EXPRESS OR IMPLIED WARRANTIES AND CONDITIONS RELATED TO SALE, USE OF PRODUCT, OR INFORMATION, INCLUDING WARRANTIES OR CONDITIONS OF MERCHANTABILITY, FITNESS FOR A PARTICULAR PURPOSE, ACCURACY OF INFORMATION, OR NONINFRINGEMENT.**
- Do not use or otherwise make available Product or related software or technology for any military purposes, including without limitation, for the design, development, use, stockpiling or manufacturing of nuclear, chemical, or biological weapons or missile technology products (mass destruction weapons). Product and related software and technology may be controlled under the applicable export laws and regulations including, without limitation, the Japanese Foreign Exchange and Foreign Trade Law and the U.S. Export Administration Regulations. Export and re-export of Product or related software or technology are strictly prohibited except in compliance with all applicable export laws and regulations.
- Please contact your TOSHIBA sales representative for details as to environmental matters such as the RoHS compatibility of Product. Please use Product in compliance with all applicable laws and regulations that regulate the inclusion or use of controlled substances, including without limitation, the EU RoHS Directive. **TOSHIBA ASSUMES NO LIABILITY FOR DAMAGES OR LOSSES OCCURRING AS A RESULT OF NONCOMPLIANCE WITH APPLICABLE LAWS AND REGULATIONS.**