

TOSHIBA



Selection Guide 2024

MOSFETs



Contents

<u>I Small Signal MOSFETs</u>	<u>3 - 17</u>
1. Over 500mA Series MOSFETs (Semi-Power Type)	3 - 8
2. Less than 500mA Series MOSFETs (Standard Type)	9 - 12
3. MOSFET with Diode	13
4. Bipolar Transistor with Diode	13
5. Part Naming Conventions	14
6. Device Packages	15 - 17
<u>II Power MOSFETs</u>	<u>18 - 41</u>
1. Low-Voltage MOSFETs Series	18 - 24
2. Mid-High Voltage MOSFETs Series	25 - 32
3. Automotive MOSFETs Series	33 - 34
4. Silicon Carbide (SiC) MOSFETs Series	35
5. Part Naming Conventions	36
6. Device Packages	37 - 41

I Small Signal MOSFETs

1. Over 500mA Series MOSFETs (Semi-Power Type)





Package Dimensions (unit: mm)

CST3C	CST3 (SOT-883)	VESM (SOT-723)	UFM (SOT-323F)	ES6 (SOT-563)	UF6 (SOT-363F)	WCSP6C
Bottom View	Bottom View					Bottom View
0.8 x 0.6	1.0 x 0.6	1.2 x 1.2	2.0 x 2.1	1.6 x 1.6	2.0 x 2.1	1.5 x 1.0

P-Channel Single MOSFET

Package	Part Number	V _{DS} (V)	V _{GS} (V)	I _D (A)	R _{DS(ON)} max (mΩ)						Q _g typ. (nC)	C _{iss} typ. (pF)	Note
					V _{GS} = -1.2 V	V _{GS} = -1.5 V	V _{GS} = -1.8 V	V _{GS} = -2.5 V	V _{GS} = -4 V	V _{GS} = -4.5 V			
CST3C	SSM3J64CTC	\$ -12	+/-10	-1	11300	1310	890	560	-	370	-	50	
	SSM3J65CTC	\$ -20	+/-10	-0.7	11300	1550	1070	700	-	500	-	48	
CST3	SSM3J56ACT	\$ -20	+/-8	-1.4	4000	900	660	480	-	390	-	1.6	100
	SSM3J76CT ★	\$ -20	+/-8	-1.4	4000	900	660	480	-	390	-	1.6	100 Low leakage current
	SSM3J65CT ☆	\$ -20	+/-10	-0.7	11300	1550	1070	700	-	500	-	48	
VESM	SSM3J66MFV #	\$ -20	+6/-8	-0.8	4000	900	660	480	-	390	-	1.6	100
	SSM3J56MFV	\$ -20	+/-8	-0.8	4000	900	660	480	-	390	-	1.6	100
	SSM3J76MFV ★	\$ -20	+/-8	-0.8	4000	900	660	480	-	390	-	1.6	100 Low leakage current
WCSP6C	SSM6J771G	\$ -20	+/-12	-5	-	-	-	47.5	-	35	34.7 (@-8 V) 31 (@-8.5 V)	9.8	870
ES6	SSM6J216FE	\$ -12	+/-8	-4.8	-	88.1	56	39.3	-	32	-	12.7	1040
	SSM6J213FE	\$ -20	+/-8	-2.6	-	250	178	133	-	103	-	4.7	290
	SSM6J215FE	\$ -20	+/-8	-3.4	-	154	104	79	-	59	-	10.4	630
	SSM6J212FE	\$ -20	+/-8	-4	-	94	65.4	49	-	40.7	-	14.1	970
	SSM6J207FE	\$ -30	+/-20	-1.4	-	-	-	-	491	-	251	-	137
	SSM6J214FE	\$ -30	+/-12	-3.6	-	-	149.6	77.6	-	57	50	7.9	560
UFM	SSM3J132TU	\$ -12	+/-6	-5.4	94	39	29	21	-	17	-	33	2700
	SSM3J135TU	\$ -20	+/-8	-3	-	260	180	132	-	103	-	4.6	270
	SSM3J145TU #	\$ -20	+6/-8	-3	-	260	180	132	-	103	-	4.6	270
	SSM3J134TU	\$ -20	+/-8	-3.2	-	240	168	123	-	93	-	4.7	290
	SSM3J144TU #	\$ -20	+6/-8	-3.2	-	240	168	123	-	93	-	4.7	290
	SSM3J130TU	\$ -20	+/-8	-4.4	-	63.2	41.1	31	-	25.8	-	24.8	1800
	SSM3J140TU #	\$ -20	+6/-8	-4.4	-	63.2	41.1	31	-	25.8	-	24.8	1800
	SSM3J133TU	\$ -20	+/-8	-5.5	-	88.4	56	39.7	-	29.8	-	12.8	840
	SSM3J143TU #	\$ -20	+6/-8	-5.5	-	88.4	56	39.7	-	29.8	-	12.8	840
	SSM3J112TU #	\$ -30	+/-20	-1.1	-	-	-	-	790	-	390	-	86
	SSM3J118TU #	\$ -30	+/-20	-1.4	-	-	-	-	480	-	240	-	137
SSM3J117TU #	\$ -30	+/-20	-2	-	-	-	-	225	-	117	-	280	
UF6	SSM6J422TU #	\$ -20	+6/-8	-4	-	99.6	67.8	51.4	-	42.7	-	12.8	840
	SSM6J412TU	\$ -20	+/-8	-4	-	99.6	67.8	51.4	-	42.7	-	12.8	840
	SSM6J424TU #	\$ -20	+6/-8	-6	-	54	36	26	-	22.5	-	23.1	1650
	SSM6J414TU	\$ -20	+/-8	-6	-	54	36	26	-	22.5	-	23.1	1650
	SSM6J402TU #	\$ -30	+/-20	-2	-	-	-	-	225	-	117	5.3	280
	SSM6J410TU #	\$ -30	+/-20	-2.1	-	-	-	-	393	-	216	2.9	120
SSM6J401TU #	\$ -30	+/-20	-2.5	-	-	-	-	145	-	73	16	730	

☆ New Products, ★ Under Development (The specification is subject to change without notice.)
AEC-Q101 qualified, \$ With protection Zener diode between gate and source







UDFN6B (SOT-1220)	SOT-23F	S-Mini (SOT-346)	TSOP6F
Bottom View 			
2.0 x 2.0	2.9 x 2.4	2.9 x 2.5	2.9 x 2.8

P-Channel Single MOSFET

Package	Part Number	V _{DSS} (V)	V _{GS} (V)	I _D (A)	R _{DS(ON)} max (mΩ)						Q _g typ. (nC)	C _{iss} typ. (pF)	Note	
					V _{GS} = -1.2 V	V _{GS} = -1.5 V	V _{GS} = -1.8 V	V _{GS} = -2.5 V	V _{GS} = -4 V	V _{GS} = -4.5 V				V _{GS} = -10 V
UDFN6B	SSM6J512NU	\$ -12	+/-10	-10	-	-	40.1	25.7	20.5 (@-3.6 V)	18.7	16.2 (@-8 V)	19.5	1400	
	SSM6J505NU	\$ -12	+/-6	-12	61	30	21	16	-	12	-	37.6	2700	
	SSM6J511NU	\$ -12	+/-10	-14	-	-	19.2	13.5	11.5 (@-3.6 V)	10	9.1 (@-8 V)	47	3350	
	SSM6J503NU	\$ -20	+/-8	-6	-	89.6	57.9	41.7	-	32.4	-	12.8	840	
	SSM6J502NU	\$ -20	+/-8	-6	-	60.5	38.4	28.3	-	23.1	-	24.8	1800	
	SSM6J501NU	\$ -20	+/-8	-10	-	43	26.5	19	-	15.3	-	29.9	2600	
	SSM6J507NU	\$ -30	+20/-25	-10	-	-	-	-	32	28	20	13.6	1150	
SOT-23F	SSM3J338R	\$ -12	+/-10	-6	-	-	45.3	27.9	21.9 (@-3.6 V)	20.2	17.6 (@-8 V)	19.5	1400	
	SSM3J327R	\$ -20	+/-8	-3.9	-	240	168	123	-	93	-	4.6	290	
	SSM3J377R	# \$ -20	+6/-8	-3.9	-	240	168	123	-	93	-	4.6	290	
	SSM3J331R	\$ -20	+/-8	-4	-	150	100	75	-	55	-	10.4	630	
	SSM3J371R	# \$ -20	+6/-8	-4	-	150	100	75	-	55	-	10.4	630	
	SSM3J328R	\$ -20	+/-8	-6	-	88.4	56	39.7	-	29.8	-	12.8	840	
	SSM3J378R	# \$ -20	+6/-8	-6	-	88.4	56	39.7	-	29.8	-	12.8	840	
	SSM3J355R	\$ -20	+/-10	-6	-	-	52.3	38.8	-	30.1	-	16.6	1030	
	SSM3J358R	\$ -20	+/-10	-6	-	-	49.3	32.8	27.7 (@-3.6 V)	25.3	22.1 (@-8 V)	38.5	1331	
	SSM3J334R	\$ -30	+/-20	-4	-	-	-	-	136	105	71	5.9	280	
	SSM3J374R	# \$ -30	+10/-20	-4	-	-	-	-	136	105	71	5.9	280	
	SSM3J340R	\$ -30	+20/-25	-4	-	-	-	-	86	73	45	6.2	492	
	SSM3J332R	\$ -30	+/-12	-6	-	-	144	72	-	50	42	8.2	560	
	SSM3J372R	# \$ -30	+6/-12	-6	-	-	144	72	-	50	42	8.2	560	
SSM3J356R	# \$ -60	+10/-20	-2	-	-	-	-	400	360	300	8.3	330		
SSM3J351R	# \$ -60	+10/-20	-3.5	-	-	-	-	184	164	134	15.1	660		
S-Mini	SSM3J325F	\$ -20	+/-8	-2	-	311	231	179	-	150	-	4.6	270	
	SSM3J375F	# \$ -20	+6/-8	-2	-	311	231	179	-	150	-	4.6	270	
	SSM3J352F	\$ -20	+/-12	-2	-	-	443	199	-	136	110	5.1	210	
	SSM3J353F	\$ -30	+20/-25	-2	-	-	-	-	274	232	150	3.4	159	
TSOP6F	SSM6J801R	\$ -20	+6/-8	-6	-	88.4	56	39.7	-	32.5	-	12.8	840	
	SSM6J825R	☆ \$ -30	+10/-20	-4	-	-	-	-	86	73	45	6.2	492	
	SSM6J808R	# -40	+10/-20	-7	-	-	-	-	52	48	35	24.2	1020	

☆ New Products



AEC-Q101 qualified, \$ With protection Zener diode between gate and source

CST3 (SOT-883)	VESM (SOT-723)	SSM (SOT-416)	UFM (SOT-323F)	ES6 (SOT-563)	UF6 (SOT-363F)	WCSP6C
Bottom View 						Bottom View 
1.0 x 0.6	1.2 x 1.2	1.6 x 1.6	2.0 x 2.1	1.6 x 1.6	2.0 x 2.1	1.5 x 1.0

N-Channel Single MOSFET

Package	Part Number	V _{DSS} (V)	V _{GS} (V)	I _D (A)	R _{DS(ON)} max (mΩ)						Q _g typ. (nC)	C _{iss} typ. (pF)	Note	
					V _{GS} = 1.2 V	V _{GS} = 1.5 V	V _{GS} = 1.8 V	V _{GS} = 2.5 V	V _{GS} = 4 V	V _{GS} = 4.5 V				V _{GS} = 10 V
CST3	SSM3K56CT	\$ 20	+/-8	0.8	-	840	480	300	-	235	-	1	55	
	SSM3K56ACT	\$ 20	+/-8	1.4	-	840	480	300	-	235	-	1	55	
	SSM3K76CT ★	\$ 20	+/-8	1.4	-	840	480	300	-	235	-	1	55	Low leakage current
VESM	SSM3K36MFV #	\$ 20	+/-10	0.5	-	1520	1140	850	-	660	630 (@5V)	1.23	46	
	SSM3K56MFV	\$ 20	+/-8	0.8	-	840	480	300	-	235	-	1	55	
	SSM3K76MFV ★	\$ 20	+/-8	0.8	-	840	480	300	-	235	-	1	55	Low leakage current
WCSP6C	SSM6K781G	12	+/-8	7	-	124	47.4	23.2	-	18	-	5.4	600	
SSM	SSM3K36FS #	\$ 20	+/-10	0.5	-	1520	1140	850	-	660	630 (@5V)	1.23	46	
	SSM3K56FS	\$ 20	+/-8	0.8	-	840	480	300	-	235	-	1	55	
	SSM3K76FS ★	\$ 20	+/-8	0.8	-	840	480	300	-	235	-	1	55	Low leakage current
ES6	SSM6K217FE	\$ 40	+/-12	1.8	-	-	400	248	218 (@3.6V) 211 (@4.2V)	208	195 (@8V)	1.1	130	
UFM	SSM3K36TU #	\$ 20	+/-10	0.5	-	1520	1140	850	-	660	630 (@5V)	1.23	46	
	SSM3K62TU #	\$ 20	+/-8	0.8	432	139	89	68	-	57	-	2	177	
	SSM3K122TU #	\$ 20	+/-10	2	-	304	211	161	123	-	-	3.4	195	
	SSM3K121TU #	\$ 20	+/-10	3.2	-	140	93	63	48	-	-	5.9	400	
	SSM3K123TU #	\$ 20	+/-10	4.2	-	66	43	32	28	-	-	13.6	1010	
	SSM3K127TU #	\$ 30	+/-12	2	-	-	286	167	123	-	-	1.5	123	
	SSM3K116TU #	\$ 30	+/-12	2.2	-	-	-	135	-	100	-	-	245	
	SSM3K131TU #	\$ 30	+/-20	6	-	-	-	-	-	41.5	27.6	10.1	450	
	SSM3H137TU #	\$ 34	+/-20	2	-	-	-	-	295	280	240	3	119	Built-in Active Clamp Zener
	SSM3K2615TU #	\$ 60	+/-20	2	-	-	-	580 (@3.3V)	440	-	300	6	150	
	SSM3K341TU #	\$ 60	+/-20	6	-	-	-	-	69	51	36	9.3	550	T _{ch} = 175 °C
SSM3K361TU #	\$ 100	+/-20	3.5	-	-	-	-	-	92	69	3.2	430	T _{ch} = 175 °C	
UF6	SSM6K405TU	\$ 20	+/-10	2	-	307	214	164	126	-	-	3.4	195	
	SSM6K404TU #	\$ 20	+/-10	3	-	147	100	70	55	-	-	5.9	400	
	SSM6K403TU #	\$ 20	+/-10	4.2	-	66	43	32	28	-	-	16.8	1050	
	SSM6K406TU #	\$ 30	+/-20	4.4	-	-	-	-	-	38.5	25	12.4	490	
	SSM6K407TU #	\$ 60	+/-20	2	-	-	-	-	440	-	300	6	150	

★ Under Development (The specification is subject to change without notice.)
AEC-Q101 qualified, \$ With protection Zener diode between gate and source





SOT-23F	TSOP6F	UDFN6B (SOT-1220)
		
2.9 x 2.4	2.9 x 2.8	2.0 x 2.0

N-Channel Single MOSFET

Package	Part Number	V _{DSS} (V)	V _{GSS} (V)	I _D (A)	R _{DS(ON)} max (mΩ)							Q _g typ. (nC)	C _{iss} typ. (pF)	Note
					V _{GS} = 1.2 V	V _{GS} = 1.5 V	V _{GS} = 1.8 V	V _{GS} = 2.5 V	V _{GS} = 4 V	V _{GS} = 4.5 V	V _{GS} = 10 V			
UDFN6B	SSM6K518NU	\$ 20	+/-8	6	-	108	74	45	-	33	-	3.6	410	
	SSM6K517NU	\$ 30	+12/-8	6	-	-	82	53	-	39.1	-	3.2	310	
	SSM6K504NU	# \$ 30	+/-20	9	-	-	-	-	-	26	19.5	4.8	620	
	SSM6K513NU	30	+/-20	15	-	-	-	-	-	12	8.9	7.5	1130	
	SSM6K516NU	\$ 30	+20/-12	6	-	-	-	-	-	64	46	2.5	280	
	SSM6K514NU	40	+/-20	12	-	-	-	-	-	17.3	11.6	7.5	1110	
	SSM6K388NU	★ 60	+/-20	2	-	-	-	-	-	98	82	TBD	TBD	
	SSM6K389NU	★ 60	+/-20	2	-	-	-	-	-	200	155	TBD	TBD	
	SSM6K341NU	\$ 60	+/-20	6	-	-	-	-	69	51	36	9.3	550	
	SSM6K387NU	★ 100	+/-20	2	-	-	-	-	-	200	125	TBD	TBD	
SOT-23F	SSM6K361NU	\$ 100	+/-20	3.5	-	-	-	-	-	92	69	3.2	430	
	SSM3K344R	\$ 20	+/-8	3	-	232	139	91	-	71	-	2	153	
	SSM3K345R	\$ 20	+/-8	4	-	108	74	45	-	33	-	3.6	410	
	SSM3K324R	\$ 30	+/-12	4	-	-	109	72	-	56	-	2.2	200	
	SSM3K376R	# \$ 30	+12/-8	4	-	-	109	72	-	56	-	2.2	200	
	SSM3K336R	# \$ 30	+/-20	3	-	-	-	-	-	140	95	1.7	126	
	SSM3K333R	# 30	+/-20	6	-	-	-	-	-	42	28	3.4	436	
	SSM3K335R	# \$ 30	+/-20	6	-	-	-	-	-	56	38	2.7	340	
	SSM3K347R	# \$ 38	+/-20	2	-	-	-	-	480	410	340	2.5	86	Built-in Active Clamp Zener
	SSM3K337R	# \$ 38	+/-20	2	-	-	-	-	200	176	150	3	120	Built-in Active Clamp Zener
	SSM3K339R	\$ 40	+/-12	2	-	-	390	238	208 (@3.6 V) 201 (@4.2 V)	198	185 (@8 V)	1.1	130	
	SSM3K357R	# \$ 60	+/-12	0.65	-	-	-	2400 (@3 V)	-	1800 (@5 V)	-	1.5	43	Built-in Gate-Drain Zener
	SSM3K2615R	# \$ 60	+/-20	2	-	-	-	580 (@3.3 V)	440	-	300	6	150	
	SSM3K388R	★ 60	+/-20	2	-	-	-	-	-	98	82	TBD	TBD	
	SSM3K389R	★ 60	+/-20	2	-	-	-	-	-	200	155	TBD	TBD	
	SSM3K318R	# \$ 60	+/-20	2.5	-	-	-	-	-	145	107	7	235	
SSM3K341R	# \$ 60	+/-20	6	-	-	-	-	69	51	36	9.3	550	T _{ch} = 175 °C	
SSM3K387R	★ 100	+/-20	2	-	-	-	-	-	200	125	TBD	TBD		
SSM3K361R	# \$ 100	+/-20	3.5	-	-	-	-	-	92	69	3.2	430	T _{ch} = 175 °C	
TSOP6F	SSM6K824R	☆ \$ 20	+/-8	6	-	108	74	45	-	33	-	3.6	410	
	SSM6K818R	☆ # 30	+/-20	15	-	-	-	-	-	12	8.9	7.5	1130	
	SSM6K804R	☆ # 40	+/-20	12	-	-	-	-	-	18	12	7.5	1110	
	SSM6K388R	★ 60	+/-20	2	-	-	-	-	-	98	82	TBD	TBD	
	SSM6K389R	★ 60	+/-20	2	-	-	-	-	-	200	155	TBD	TBD	
	SSM6K809R	# \$ 60	+/-20	6	-	-	-	-	69	51	36	9.3	550	T _{ch} = 175 °C
	SSM6K387R	★ 100	+/-20	2	-	-	-	-	-	200	125	TBD	TBD	
	SSM6K810R	# \$ 100	+/-20	3.5	-	-	-	-	-	92	69	3.2	430	T _{ch} = 175 °C
SSM6K819R	# \$ 100	+/-20	10	-	-	-	-	-	36.4	25.8	8.5	1110	T _{ch} = 175 °C	

☆ New Products, ★ Under Development (The specification is subject to change without notice.)







AEC-Q101 qualified, \$ With protection Zener diode between gate and source

ES6 (SOT-563)	UF6 (SOT-363F)	UDFN6 (SOT-1118)	DFN2020(WF)
		Bottom View 	Bottom View 
1.6 x 1.6	2.0 x 2.1	2.0 x 2.0	2.0 x 2.0

Dual MOSFET

Package	Polarity	Part Number	V _{bss} (V)	V _{gss} (V)	I _D (A)	R _{DS(on)} max (mΩ)						Q _g typ. (nC)	C _{iss} typ. (pF)	Note	
						V _{gs} = 1.2 V	V _{gs} = 1.5 V	V _{gs} = 1.8 V	V _{gs} = 2.5 V	V _{gs} = 4 V	V _{gs} = 4.5 V				V _{gs} = 10 V
ES6	P-ch x2	SSM6P41FE	\$ -20	+/-8	-0.72	-	1040	670	440	-	300	-	1.76	110	
		SSM6P56FE	\$ -20	+/-8	-0.8	4000	900	660	480	-	390	-	1.6	100	
		SSM6P76FE ★	\$ -20	+/-8	-0.8	4000	900	660	480	-	390	-	1.6	100	Low leakage current
	N-ch x2	SSM6N36FE #	\$ 20	+/-10	0.5	-	1520	1140	850	-	660	630 (@5V)	1.23	46	
		SSM6N56FE	\$ 20	+/-8	0.8	-	840	480	300	-	235	-	1	55	
		SSM6N76FE ★	\$ 20	+/-8	0.8	-	840	480	300	-	235	-	1	55	Low leakage current
	N-ch + P-ch	SSM6L14FE	\$ 20	+/-10	0.8	-	600	450	330	-	240	-	2	90	
SSM6L56FE		\$ 20	+/-8	0.8	-	840	480	300	-	235	-	1	55		
			\$ -20	+/-8	-0.8	4000	900	660	480	-	390	-	1.6	100	
UDFN6	P-ch x2	SSM6P47NU	\$ -20	+/-8	-4	-	242	170	125	-	95	-	4.6	290	
		SSM6P69NU #	\$ -20	+6/-12	-4	-	-	157	76	-	56	45	6.74	480	
		SSM6P49NU	\$ -20	+/-12	-4	-	-	157	76	-	56	45	6.74	480	
	N-ch x2	SSM6N61NU #	\$ 20	+/-8	4	-	108	74	45	-	33	-	3.6	410	
		SSM6N55NU	\$ 30	+/-20	4	-	-	-	-	-	64	46	2.5	280	
		SSM6N67NU #	\$ 30	+12/-8	4	-	-	82	53	-	39.1	-	3.2	310	
		SSM6N68NU #	\$ 30	+12/-8	4	-	-	180	117	-	84	-	1.8	129	
		SSM6N57NU	\$ 30	+/-12	4	-	-	82	53	-	39.1	-	3.2	310	
	SSM6N58NU	\$ 30	+/-12	4	-	-	180	117	-	84	-	1.8	129		
	N-ch + P-ch	SSM6L61NU	\$ 20	+/-8	4	-	108	74	45	-	33	-	3.6	410	
		\$ -20	+/-12	-4	-	-	157	76	-	56	45	6.74	480		
DFN2020 (WF)	N-ch x2	XSM6N65NW ★ #	\$ 30	+20/-12	4	-	-	-	-	64	-	2.5	280	Automotive equipment	
		XSM6N67NW ★ #	\$ 30	+12/-8	4	-	-	82	53	-	39.1	-	3.2	310	
UF6	P-ch x2	SSM6P39TU #	\$ -20	+/-8	-1.5	-	-	430	294	213	-	-	6.4	250	
		SSM6P40TU #	\$ -30	+/-20	-1.4	-	-	-	-	403	-	226	2.9	120	
			\$ 20	+/-10	0.5	-	1520	1140	850	-	660	630 (@5V)	1.23	46	
	N-ch x2	SSM6N36TU #	\$ 20	+/-8	0.8	456	173	120	98	-	85	-	2	177	
		SSM6N62TU #	\$ 20	+/-10	1.6	-	247	190	139	119	-	-	7.5	260	
		SSM6N24TU #	\$ 30	+/-12	0.5	-	-	-	180	-	145	-	-	245	
		SSM6N40TU #	\$ 30	+/-20	1.6	-	-	-	-	182	-	122	5.1	180	
	N-ch + P-ch	SSM6L39TU #	\$ 20	+/-10	1.6	-	247	190	139	119	-	-	7.5	260	
			\$ -20	+/-8	-1.5	-	-	430	294	213	-	-	6.4	250	
		SSM6L12TU #	\$ 30	+/-12	0.5	-	-	-	180	-	145	-	-	245	
			\$ -20	+/-12	-0.5	-	-	-	430	260	-	-	-	218	
		\$ 30	+/-20	1.6	-	-	-	-	182	-	122	5.1	180		
		\$ -30	+/-20	-1.4	-	-	-	-	403	-	226	2.9	120		

★ Under Development (The specification is subject to change without notice.)
AEC-Q101 qualified, \$ With protection Zener diode between gate and source

US6 (SOT-363)	TSOP6F	TCSPA- 172101	TCSPAC- 153001	TCSPED- 302701	TCSPAG- 341501
					
Bottom View	Bottom View	Bottom View	Bottom View	Bottom View	Bottom View
2.0 x 2.1	2.9 x 2.8	2.14 x 1.67	2.98 x 1.49	3.0 x 2.74	3.37 x 1.47

Dual MOSFET





Package	Polarity	Part Number	V _{DSS} or V _{SSS} (V)	V _{GS} (V)	I _D or I _S (A)	R _{DS(ON)} max or R _{SS(ON)} max (mΩ)							Q _g typ. (nC)	C _{iss} typ. (pF)	Note
						V _{GS} = 1.2 V	V _{GS} = 1.5 V	V _{GS} = 1.8 V	V _{GS} = 2.5 V	V _{GS} = 4 V	V _{GS} = 4.5 V	V _{GS} = 10 V			
US6	N-ch x2	SSM6N43FU # \$	20	+/-10	0.5	-	1520	1140	850	-	660	630 (@5 V)	1.23	46	
TSOP6F	N-ch x2	SSM6N357R # \$	60	+/-12	0.65	-	-	-	2400 (@3 V)	-	1800 (@5 V)	-	1.5	43	Built-in Gate- Drain Zener
		SSM6N815R \$	100	+/-20	2	-	-	-	-	180	142	103	3.1	290	
		SSM6N813R # \$	100	+/-20	3.5	-	-	-	-	-	154	112	3.6	242	T _{ch} = 175 °C
	P-ch x2	SSM6P816R \$	-20	+/-10	-6	-	-	52.3	38.8	-	30.1	-	16.6	1030	
	N-ch + P-ch	SSM6L807R \$	30	+/-12	4	-	-	82	53	-	39.1	-	3.2	310	
-20			+/-12	-4	-	-	157	76	-	56	45	6.74	480		
		SSM6L820R # \$	30	+12/-8	4	-	-	82	53	-	39.1	-	3.2	310	
			-20	+6/-12	-4	-	-	157	76	-	56	45	6.7	480	
TCSPA- 172101	N-ch x2	SSM6N951L \$	12	+/-8	8	-	-	-	10	5.5 (@3.8 V)	5.1	-	26	-	Drain common
TCSPAC- 153001	N-ch x2	SSM10N954L \$	12	+/-8	13.5	-	-	-	6.1	2.85 (@3.8 V)	2.75	-	25	-	Drain common
TCSPED- 302701	N-ch x2	SSM14N956L ☆ \$	12	+/-8	20	-	-	-	3.2	1.5 (@3.8 V)	1.35	-	76	-	Drain common
TCSPAG- 341501	N-ch x2	SSM10N961L ☆ \$	30	+/-20	14	-	-	-	-	-	17.6	12.8	8.8	-	Drain common

☆ New Products

AEC-Q101 qualified, \$ With protection Zener diode between gate and source

2. Less than 500mA Series MOSFETs (Standard Type)







Package Dimensions (unit: mm)

CST3C	CST3 (SOT-883)	VESM (SOT-723)	SSM (SOT-416)	UFM (SOT-323F)	USM (SOT-323)	S-Mini (SOT-346)
Bottom View	Bottom View					
0.8 x 0.6	1.0 x 0.6	1.2 x 1.2	1.6 x 1.6	2.0 x 2.1	2.0 x 2.1	2.9 x 2.5

P-Channel Single MOSFET

Package	Part Number	V _{DSS} (V)	V _{GSS} (V)	I _D (A)	R _{DS(on)} max (Ω)							Note
					V _{GS} = -1.2 V	V _{GS} = -1.5 V	V _{GS} = -1.8 V	V _{GS} = -2.5 V	V _{GS} = -4 V	V _{GS} = -4.5 V	V _{GS} = -10 V	
CST3C	SSM3J35CTC	\$ -20	+/-10	-0.25	20	4	2.9	2.1	-	1.4	-	
	SSM3J78CTC	★ \$ -20	+/-10	-0.25	20	4	2.9	2.1	-	1.4	-	Low leakage current
CST3	SSM3J35CT	\$ -20	+/-10	-0.1	44	22	-	11	8	-	-	
	SSM3J16CT	● \$ -20	+/-10	-0.1	-	45	-	12	8	-	-	⇒ SSM3J35CT
VESM	SSM3J15CT	\$ -30	+/-20	-0.1	-	-	-	32	12	-	-	
	SSM3J35MFV	# \$ -20	+/-10	-0.1	44	22	-	11	8	-	-	⇒ SSM3J35AMFV (General purpose) ⇒ SSM3J35MFV,LXGF(T) (Automotive equipment)
	SSM3J36MFV	# \$ -20	+/-8	-0.33	-	3.6	2.7	1.6 (@-2.8 V)	-	1.31	-	⇒ SSM3J56MFV (General purpose) ⇒ SSM3J36MFV,LXGF(T) (Automotive equipment)
	SSM3J35AMFV	\$ -20	+/-10	-0.25	20	4	2.9	2.1	-	1.4	-	
	SSM3J78MFV	★ \$ -20	+/-10	-0.25	20	4	2.9	2.1	-	1.4	-	Low leakage current
SSM	SSM3J15FV	# \$ -30	+/-20	-0.1	-	-	-	32	12	-	-	
	SSM3J35FS	# \$ -20	+/-10	-0.1	44	22	-	11	8	-	-	⇒ SSM3J35AFS (General purpose) ⇒ SSM3J35FS,LXGF(T) (Automotive equipment)
	SSM3J35AFS	\$ -20	+/-10	-0.25	20	4	2.9	2.1	-	1.4	-	
	SSM3J78FS	★ \$ -20	+/-10	-0.25	20	4	2.9	2.1	-	1.4	-	Low leakage current
	SSM3J36FS	# \$ -20	+/-8	-0.33	-	3.6	2.7	1.6 (@-2.8 V)	-	1.31	-	
UFM	SSM3J15FS	# \$ -30	+/-20	-0.1	-	-	-	32	12	-	-	
USM	SSM3J36TU	# \$ -20	+/-8	-0.33	-	3.6	2.7	1.6 (@-2.8 V)	-	1.31	-	
S-Mini	SSM3J15FU	# \$ -30	+/-20	-0.1	-	-	-	32	12	-	-	
	SSM3J15F	# \$ -30	+/-20	-0.1	-	-	-	32	12	-	-	
	2SJ305	\$ -30	+/-20	-0.2	-	-	-	4	-	-	-	
	SSM3J168F	# \$ -60	+10/-20	-0.4	-	-	-	-	2	1.9	1.55	





● Recommended Another New Product, ★ Under Development (The specification is subject to change without notice.)
AEC-Q101 qualified, \$ With protection Zener diode between gate and source

CST3C	CST3 (SOT-883)	VESM (SOT-723)	SSM (SOT-416)	USM (SOT-323)	SOT23 (SOT-23)	S-Mini (SOT-346)
Bottom View 	Bottom View 					
0.8 x 0.6	1.0 x 0.6	1.2 x 1.2	1.6 x 1.6	2.0 x 2.1	2.9 x 2.4	2.9 x 2.5

N-Channel Single MOSFET

Package	Part Number	V _{DSS} (V)	V _{GSS} (V)	I _D (A)	R _{Dson} (max) (Ω)						Note		
					V _{GS} = 1.2 V	V _{GS} = 1.5 V	V _{GS} = 1.8 V	V _{GS} = 2.5 V	V _{GS} = 4 V	V _{GS} = 4.5 V		V _{GS} = 5 V	V _{GS} = 10 V
CST3C	SSM3K35CTC	\$ 20	+/-10	0.25	9	3.1	2.4	1.6	-	1.1	-	-	
	SSM3K78CTC ★	\$ 20	+/-10	0.25	9	3.1	2.4	1.6	-	1.1	-	-	Low leakage current
	SSM3K15ACTC	\$ 30	+/-20	0.1	-	-	-	6	3.6	-	-	-	
	SSM3K79CTC ★	\$ 30	+/-20	0.1	-	-	-	6	3.6	-	-	-	Low leakage current
	SSM3K72CTC	\$ 60	+/-20	0.15	-	-	-	5.7 (typ.)	-	4.7	4.4	3.9	
CST3	SSM3K16CTC	\$ 20	+/-10	0.1	-	15	-	4	3	-	-	-	
	SSM3K35CTC	\$ 20	+/-10	0.18	20	8	-	4	3	-	-	-	
	SSM3K37CTC	\$ 20	+/-10	0.2	-	5.6	4.05	3.02	-	2.2	-	-	
	SSM3K77CTC ★	\$ 20	+/-10	0.2	-	5.6	4.05	3.1	-	2.2	-	-	Low leakage current
	SSM3K15CTC ●	\$ 30	+/-20	0.1	-	-	-	7	4	-	-	-	⇒ SSM3K15ACT
	SSM3K15ACT	\$ 30	+/-20	0.1	-	-	-	6	3.6	-	-	-	
	SSM3K79CTC ★	\$ 30	+/-20	0.1	-	-	-	6	3.6	-	-	-	Low leakage current
	SSM3K72KCT	\$ 60	+/-20	0.4	-	-	-	-	-	1.75	1.65	1.5	
	SSM3K16FV	\$ 20	+/-10	0.1	-	15	-	4	3	-	-	-	
VESM	SSM3K35MFV #	\$ 20	+/-10	0.18	20	8	-	4	3	-	-	-	⇒ SSM3K35AMFV (General purpose) ⇒ SSM3K35MFV,LXGF(T) (Automotive equipment)
	SSM3K37MFV	\$ 20	+/-10	0.25	-	5.6	4.05	3.02	-	2.2	-	-	
	SSM3K77MFV ★	\$ 20	+/-10	0.25	-	5.6	4.05	3.1	-	2.2	-	-	Low leakage current
	SSM3K35AMFV	\$ 20	+/-10	0.25	9	3.1	2.4	1.6	-	1.1	-	-	
	SSM3K78MFV ★	\$ 20	+/-10	0.25	9	3.1	2.4	1.6	-	1.1	-	-	Low leakage current
	SSM3K15AMFV	\$ 30	+/-20	0.1	-	-	-	6	3.6	-	-	-	
	SSM3K79MFV ★	\$ 30	+/-20	0.1	-	-	-	6	3.6	-	-	-	Low leakage current
	SSM3K44MFV #	\$ 30	+/-20	0.1	-	-	-	7	4	-	-	-	
SSM	SSM3K16FS	\$ 20	+/-10	0.1	-	15	-	4	3	-	-	-	⇒ SSM3K37FS
	SSM3K35FS #	\$ 20	+/-10	0.18	20	8	-	4	3	-	-	-	⇒ SSM3K35AFS (General purpose) ⇒ SSM3K35FS,LXGF(T) (Automotive equipment)
	SSM3K37FS	\$ 20	+/-10	0.2	-	5.6	4.05	3.02	-	2.2	-	-	
	SSM3K77FS ★	\$ 20	+/-10	0.2	-	5.6	4.05	3.1	-	2.2	-	-	Low leakage current
	SSM3K35AFS	\$ 20	+/-10	0.25	9	3.1	2.4	1.6	-	1.1	-	-	
	SSM3K78FS ★	\$ 20	+/-10	0.25	9	3.1	2.4	1.6	-	1.1	-	-	Low leakage current
	SSM3K15FS ● #	\$ 30	+/-20	0.1	-	-	-	7	4	-	-	-	⇒ SSM3K15AFS (General purpose) ⇒ SSM3K44FS,LXGF(T) (Automotive equipment)
	SSM3K44FS #	\$ 30	+/-20	0.1	-	-	-	7	4	-	-	-	
	SSM3K15AFS	\$ 30	+/-20	0.1	-	-	-	6	3.6	-	-	-	
	SSM3K79FS ★	\$ 30	+/-20	0.1	-	-	-	6	3.6	-	-	-	Low leakage current
	SSM3K72CFs	\$ 60	+/-20	0.17	-	-	-	-	-	4.7	4.4	3.9	
	SSM3K72KFs #	\$ 60	+/-20	0.3	-	-	-	-	-	1.75	1.65	1.5	
	SSM3K16FU	\$ 20	+/-10	0.1	-	15	-	4	3	-	-	-	
USM	SSM3K15FU #	\$ 30	+/-20	0.1	-	-	-	7	4	-	-	-	⇒ SSM3K15AFU (General purpose) ⇒ SSM3K15FU,LXGF(T) (Automotive equipment)
	SSM3K15AFU	\$ 30	+/-20	0.1	-	-	-	6	3.6	-	-	-	
	SSM3K79FU ★	\$ 30	+/-20	0.1	-	-	-	6	3.6	-	-	-	Low leakage current
	SSM3K48FU ●	\$ 30	+/-20	0.1	-	-	-	5.4	3.2	-	-	-	⇒ SSM3K15AFU
	SSM3K09FU	\$ 30	+/-20	0.4	-	-	-	1.7 (@3.3V)	1.2	-	-	0.7	
	SSM3K17FU #	\$ 50	+/-7	0.1	-	-	-	40	20	-	-	-	
	SSM3K7002CFU	\$ 60	+/-20	0.17	-	-	-	-	-	4.7	4.4	3.9	
SOT23	SSM3K7002KFU #	\$ 60	+/-20	0.4	-	-	-	-	-	1.75	1.65	1.5	
	T2N7002AK	\$ 60	+/-20	0.2	-	-	-	-	-	4.7	4.4	3.9	
	T2N7002BK	\$ 60	+/-20	0.4	-	-	-	-	-	1.75	1.65	1.5	
S-Mini	SSM3K15F #	\$ 30	+/-20	0.1	-	-	-	7	4	-	-	-	
	2SK2009	\$ 30	+/-20	0.2	-	-	-	2	-	-	-	-	
	SSM3K7002KF #	\$ 60	+/-20	0.4	-	-	-	-	-	1.75	1.65	1.5	

● Recommended Another New Product, # AEC-Q101 qualified, \$ With protection Zener diode between gate and source
★ Under Development (The specification is subject to change without notice.)

ESV (SOT-553)	ES6 (SOT-563)	USV (SOT-353)	UF6 (SOT-363F)
			
1.6 x 1.6	1.6 x 1.6	2.0 x 2.1	2.0 x 2.1

Dual MOSFET

Package	Polarity	Part Number	V _{BSS} (V)	V _{GSS} (V)	I _D (A)	R _{DS(ON)} max (Ω)								Note
						V _{GSS} = 1.2 V	V _{GSS} = 1.5 V	V _{GSS} = 1.8 V	V _{GSS} = 2.5 V	V _{GSS} = 4 V	V _{GSS} = 4.5 V	V _{GSS} = 5 V	V _{GSS} = 10 V	
ESV	P-ch x2	SSM5P16FE	\$ -20	+/-10	-0.1	-	45	-	12	8	-	-	-	
	N-ch x2	SSM5N16FE	\$ 20	+/-10	0.1	-	15	-	4	3	-	-	-	
		SSM5N15FE	\$ 30	+/-20	0.1	-	-	-	7	4	-	-	-	
ES6	P-ch x2	SSM6P35FE #	\$ -20	+/-10	-0.1	44	22	-	11	8	-	-	-	⇒ SSM6P35AFE (General purpose) ⇒ SSM6P35FE, LXGM(T) (Automotive equipment)
		SSM6P35AFE	\$ -20	+/-10	-0.25	20	4	2.9	2.1	-	1.4	-	-	
		SSM6P78FE ★	\$ -20	+/-10	-0.25	20	4	2.9	2.1	-	1.4	-	-	Low leakage current
		SSM6P36FE #	\$ -20	+/-8	-0.33	-	3.6	2.7	1.6 (@-2.8 V)	-	1.31	-	-	
	SSM6P15FE #	\$ -30	+/-20	-0.1	-	-	-	32	12	-	-	-		
	N-ch x2	SSM6N16FE	\$ 20	+/-10	0.1	-	15	-	4	3	-	-	-	
		SSM6N35FE #	\$ 20	+/-10	0.18	20	8	-	4	3	-	-	-	⇒ SSM6N35AFE (General purpose) ⇒ SSM6N35FE, LXGM(T) (Automotive equipment)
		SSM6N37FE	\$ 20	+/-10	0.25	-	5.6	4.05	3.02	-	2.2	-	-	
		SSM6N77FE ★	\$ 20	+/-10	0.25	-	5.6	4.05	3.1	-	2.2	-	-	Low leakage current
		SSM6N35AFE	\$ 20	+/-10	0.25	9	3.1	2.4	1.6	-	1.1	-	-	
		SSM6N78FE ★	\$ 20	+/-10	0.25	9	3.1	2.4	1.6	-	1.1	-	-	Low leakage current
		SSM6N44FE #	\$ 30	+/-20	0.1	-	-	-	7	4	-	-	-	
		SSM6N15AFE	\$ 30	+/-20	0.1	-	-	-	6	3.6	-	-	-	
	SSM6N79FE ★	\$ 30	+/-20	0.1	-	-	-	6	3.6	-	-	-	Low leakage current	
	SSM6N7002BFE	\$ 60	+/-20	0.2	-	-	-	-	-	3.3	2.6	2.1		
N-ch + P-ch	SSM6L35FE #	\$ 20	+/-10	0.18	20	8	-	4	3	-	-	-		
	SSM6L36FE #	\$ 20	+/-10	0.5	-	1.52	1.14	0.85	-	0.66	0.63	-		
			\$ -20	+/-8	-0.33	-	3.6	2.7	1.6 (@-2.8 V)	-	1.31	-	-	
USV	P-ch x2	SSM5P15FU	\$ -30	+/-20	-0.1	-	-	-	32	12	-	-	-	
	N-ch x2	SSM5N16FU	\$ 20	+/-10	0.1	-	15	-	4	3	-	-	-	
		SSM5N15FU	\$ 30	+/-20	0.1	-	-	-	7	4	-	-	-	
UF6	P-ch x2	SSM6P36TU #	\$ -20	+/-8	-0.33	-	3.6	2.7	1.6 (@-2.8 V)	-	1.31	-	-	
	N-ch + P-ch	SSM6L36TU #	\$ 20	+/-10	0.5	-	1.52	1.14	0.85	-	0.66	0.63	-	
				\$ -20	+/-8	-0.33	-	3.6	2.7	1.6 (@-2.8 V)	-	1.31	-	-

AEC-Q101 qualified, \$ With protection Zener diode between gate and source
★ Under Development (The specification is subject to change without notice.)



Dual MOSFET



Package	Polarity	Part Number	V _{DSS} (V)	V _{GSS} (V)	I _D (A)	R _{DS(ON)} max (Ω)								Note
						V _{GS} = 1.2 V	V _{GS} = 1.5 V	V _{GS} = 1.8 V	V _{GS} = 2.5 V	V _{GS} = 4 V	V _{GS} = 4.5 V	V _{GS} = 5 V	V _{GS} = 10 V	
US6	P-ch x 2	SSM6P35FU # \$	-20	+/-10	-0.1	44	22	-	11	8	-	-	-	⇒ SSM6P35AFU (General purpose) ⇒ SSM6P35FU,LXGF(T) (Automotive equipment)
		SSM6P35AFU \$	-20	+/-10	-0.25	20	4	2.9	2.1	-	1.4	-	-	
		SSM6P78FU ★ \$	-20	+/-10	-0.25	20	4	2.9	2.1	-	1.4	-	-	Low leakage current
		SSM6P15FU # \$	-30	+/-20	-0.1	-	-	-	32	12	-	-	-	
	N-ch x 2	SSM6N16FU \$	20	+/-10	0.1	-	15	-	4	3	-	-	-	
		SSM6N35FU # \$	20	+/-10	0.18	20	8	-	4	3	-	-	-	⇒ SSM6N35AFU (General purpose) ⇒ SSM6N35FU,LXGF(T) (Automotive equipment)
		SSM6N35AFU \$	20	+/-10	0.25	9	3.1	2.4	1.6	-	1.1	-	-	
		SSM6N78FU ★ \$	20	+/-10	0.25	9	3.1	2.4	1.6	-	1.1	-	-	Low leakage current
		SSM6N37FU \$	20	+/-10	0.25	-	5.6	4.05	3.02	-	2.2	-	-	
		SSM6N77FU ★ \$	20	+/-10	0.25	-	5.6	4.05	3.1	-	2.2	-	-	Low leakage current
		SSM6N48FU ● \$	30	+/-20	0.1	-	-	-	5.4	3.2	-	-	-	⇒ SSM6N15AFU
		SSM6N44FU # \$	30	+/-20	0.1	-	-	-	7	4	-	-	-	
		SSM6N15FU ● \$	30	+/-20	0.1	-	-	-	7	4	-	-	-	⇒ SSM6N15AFU
		SSM6N15AFU \$	30	+/-20	0.1	-	-	-	6	3.6	-	-	-	
		SSM6N79FU ★ \$	30	+/-20	0.1	-	-	-	6	3.6	-	-	-	Low leakage current
		SSM6N09FU \$	30	+/-20	0.4	-	-	-	1.7 (@3.3V)	1.2	-	-	0.7	
		SSM6N17FU # \$	50	+/-7	0.1	-	-	-	40	20	-	-	-	
		SSM6N7002CFU \$	60	+/-20	0.17	-	-	-	-	-	4.7	4.4	3.9	
	SSM6N7002KFU # \$	60	+/-20	0.3	-	-	-	-	-	1.75	1.65	1.5		
	N-ch + P-ch	SSM6L35FU # \$	20	+/-10	0.18	20	8	-	4	3	-	-	-	
		SSM6L09FU ● \$	30	+/-20	0.4	-	-	-	1.7 (@3.3V)	1.2	-	-	0.7	⇒ SSM6L40TU
				-30	+/-20	-0.2	-	-	-	6 (@-3.3V)	4.2	-	-	2.7

● Recommended Another New Product, # AEC-Q101 qualified, \$ With protection Zener diode between gate and source

★ Under Development (The specification is subject to change without notice.)

3. MOSFET with Diode

Package Dimensions (unit: mm)

ESV (SOT-553)	UFV (SOT-353F)	UDFN6 (SOT-1118)
		
1.6 x 1.6	2.0 x 2.1	2.0 x 2.0

Package	Polarity	Part Number	V _{DSS} (V)	V _{GSS} (V)	I _D (A)	MOSFET							Diode				Note	
						R _{DS(ON)} max (mΩ)							C _{iss} typ. (pF)	V _R (V)	I _O (A)	V _F max (V)		
						V _{Gs} = 1.5 V	V _{Gs} = 1.8 V	V _{Gs} = 2.5 V	V _{Gs} = 4 V	V _{Gs} = 4.5 V	V _{Gs} = 5 V	V _{Gs} = 10 V				@I _F (A)		@I _F (A)
ESV	P-ch + SBD	SSM5G06FE	\$ -20	+/-10	-0.1	45000	-	12000	8000	-	-	-	11	12	0.1	0.5	0.1	
	N-ch + SBD	SSM5H06FE	\$ 20	+/-10	0.1	15000	-	4000	3000	-	-	-	9.3	12	0.1	0.5	0.1	
UFV	P-ch + SBD	SSM5G02TU	\$ -12	+/-12	-1	-	-	240	160	-	-	-	310	12	0.5	0.43	0.5	
		SSM5G09TU	\$ -12	+/-8	-1.5	-	-	200	130	-	-	-	550	12	0.5	0.43	0.5	
		SSM5G11TU	\$ -30	+/-20	-1.4	-	-	-	403	-	-	226	120	30 (¥)	0.7 (¥¥)	0.44	0.7 (¥¥)	
	N-ch + SBD	SSM5H16TU	\$ 30	+/-12	1.9	-	296	177	133	-	-	-	123	30	0.8	0.55	0.8	
	N-ch + Switching Diode	SSM5H90ATU	\$ 20	+/-10	2.4	-	-	89	65	-	-	-	200	80	0.1	1.2	0.1	
UDFN6	P-ch + SBD	SSM6G18NU	\$ -20	+/-8	-2	261	185	143	-	112	-	-	270	30	1	0.58	1	
	N-ch + SBD	SSM6H19NU	\$ 40	+/-12	2	-	390	238	208 (@3.6V) 201 (@4.2V)	198	-	185 (@8V)	130	40	0.5	0.57	0.5	

\$ With protection Zener diode between gate and source, ¥ V_{RRM}, ¥¥ I_{F(AV)}

4. Bipolar transistor with Diode

Package Dimensions (unit: mm)

SM6 (SOT-26)

2.9 x 2.8

Package	Polarity	Part Number	V _{CEO} (V)	I _C (A)	PNP transistor			Switching Diode				Note
					h _{FE}	V _{CE(sat)} max (V) I _C = -10 mA, I _B = -1 mA	C _{ob} typ. (pF)	V _R (V)	I _O (A)	V _F max (V)		
										V _{CE} = -6 V, I _C = -1 mA	@I _F (A)	
SM6	PNP + Switching Diode	HN2E04F	-120	-0.1	200 to 700	-0.3	4	80	0.1	1.2	0.1	

5. Part Naming Conventions

Small Signal MOSFET SSM / XSM Series

Ex.) SSM 3 K 329 _ R
 ① ② ③ ④ ⑤ ⑥

- | | | | | | | | | | | | | | | | | | | | | | | | | | | | | | | | | | | | | | | | | | | | | | | | | | | | | | | | | | | | | | | | | | | | | | | | | | |
|--|---|--------|--------------------|-------|--------|--|---------|--|---------|--|---------|--|---------|--|----------|--|---------|--|---------|-------|-----------|--|----------|--|-------------|--|------------|--|-----------------|--|------------|--|-----------|--|------------|--|---------|--|--|--|---------|--|--|--|---------|--|--|--|--------------------|--|--|--|-----------------|--|--|--------|-------------|--|--|--|-----------------|--|--|--|-----------------|--|--|--------|-------------|--|--|--|-----------------|
| <p>① Small-Signal MOSFET
 SSM: Initial of "Small-Signal MOSFET"
 XSM: Initial of "Automotive Small-Signal MOSFET"</p> <p>② Pin count</p> <p>③ Polarity and internal configuration
 K: N-channel, single
 J: P-channel, single
 N: N-channel, dual
 P: P-channel, dual
 L: N-channel and P-channel (dual)
 E: N-channel and P-channel (pre-wired as a load switch)
 H: N-channel and SBD (or Switching diode)
 G: P-channel and SBD</p> | <p>④ Serial number of the products</p> <p>⑤ There may be a symbol that indicates chip change etc.</p> <p>⑥ Package</p> <table border="0"> <tr> <td>3-pin</td> <td>F: S-Mini</td> <td>5-pin</td> <td>F: SMV</td> </tr> <tr> <td></td> <td>FU: USM</td> <td></td> <td>FU: USV</td> </tr> <tr> <td></td> <td>FS: SSM</td> <td></td> <td>FE: ESV</td> </tr> <tr> <td></td> <td>FV: VESM</td> <td></td> <td>TU: UFV</td> </tr> <tr> <td></td> <td>TU: UFM</td> <td>6-pin</td> <td>G: WCSP6C</td> </tr> <tr> <td></td> <td>CT: CST3</td> <td></td> <td>L: Chip LGA</td> </tr> <tr> <td></td> <td>CTB: CST3B</td> <td></td> <td>(TCSP6A-172101)</td> </tr> <tr> <td></td> <td>CTC: CST3C</td> <td></td> <td>R: TSOP6F</td> </tr> <tr> <td></td> <td>R: SOT-23F</td> <td></td> <td>FU: US6</td> </tr> <tr> <td></td> <td></td> <td></td> <td>FE: ES6</td> </tr> <tr> <td></td> <td></td> <td></td> <td>TU: UF6</td> </tr> <tr> <td></td> <td></td> <td></td> <td>NU: UDFN6 / UDFN6B</td> </tr> <tr> <td></td> <td></td> <td></td> <td>NW: DFN2020(WF)</td> </tr> <tr> <td></td> <td></td> <td>10-pin</td> <td>L: Chip LGA</td> </tr> <tr> <td></td> <td></td> <td></td> <td>(TCSPAC-153001)</td> </tr> <tr> <td></td> <td></td> <td></td> <td>(TCSPAG-341501)</td> </tr> <tr> <td></td> <td></td> <td>14-pin</td> <td>L: Chip LGA</td> </tr> <tr> <td></td> <td></td> <td></td> <td>(TCSPED-302701)</td> </tr> </table> | 3-pin | F: S-Mini | 5-pin | F: SMV | | FU: USM | | FU: USV | | FS: SSM | | FE: ESV | | FV: VESM | | TU: UFV | | TU: UFM | 6-pin | G: WCSP6C | | CT: CST3 | | L: Chip LGA | | CTB: CST3B | | (TCSP6A-172101) | | CTC: CST3C | | R: TSOP6F | | R: SOT-23F | | FU: US6 | | | | FE: ES6 | | | | TU: UF6 | | | | NU: UDFN6 / UDFN6B | | | | NW: DFN2020(WF) | | | 10-pin | L: Chip LGA | | | | (TCSPAC-153001) | | | | (TCSPAG-341501) | | | 14-pin | L: Chip LGA | | | | (TCSPED-302701) |
| 3-pin | F: S-Mini | 5-pin | F: SMV | | | | | | | | | | | | | | | | | | | | | | | | | | | | | | | | | | | | | | | | | | | | | | | | | | | | | | | | | | | | | | | | | | | | | | |
| | FU: USM | | FU: USV | | | | | | | | | | | | | | | | | | | | | | | | | | | | | | | | | | | | | | | | | | | | | | | | | | | | | | | | | | | | | | | | | | | | | | |
| | FS: SSM | | FE: ESV | | | | | | | | | | | | | | | | | | | | | | | | | | | | | | | | | | | | | | | | | | | | | | | | | | | | | | | | | | | | | | | | | | | | | | |
| | FV: VESM | | TU: UFV | | | | | | | | | | | | | | | | | | | | | | | | | | | | | | | | | | | | | | | | | | | | | | | | | | | | | | | | | | | | | | | | | | | | | | |
| | TU: UFM | 6-pin | G: WCSP6C | | | | | | | | | | | | | | | | | | | | | | | | | | | | | | | | | | | | | | | | | | | | | | | | | | | | | | | | | | | | | | | | | | | | | | |
| | CT: CST3 | | L: Chip LGA | | | | | | | | | | | | | | | | | | | | | | | | | | | | | | | | | | | | | | | | | | | | | | | | | | | | | | | | | | | | | | | | | | | | | | |
| | CTB: CST3B | | (TCSP6A-172101) | | | | | | | | | | | | | | | | | | | | | | | | | | | | | | | | | | | | | | | | | | | | | | | | | | | | | | | | | | | | | | | | | | | | | | |
| | CTC: CST3C | | R: TSOP6F | | | | | | | | | | | | | | | | | | | | | | | | | | | | | | | | | | | | | | | | | | | | | | | | | | | | | | | | | | | | | | | | | | | | | | |
| | R: SOT-23F | | FU: US6 | | | | | | | | | | | | | | | | | | | | | | | | | | | | | | | | | | | | | | | | | | | | | | | | | | | | | | | | | | | | | | | | | | | | | | |
| | | | FE: ES6 | | | | | | | | | | | | | | | | | | | | | | | | | | | | | | | | | | | | | | | | | | | | | | | | | | | | | | | | | | | | | | | | | | | | | | |
| | | | TU: UF6 | | | | | | | | | | | | | | | | | | | | | | | | | | | | | | | | | | | | | | | | | | | | | | | | | | | | | | | | | | | | | | | | | | | | | | |
| | | | NU: UDFN6 / UDFN6B | | | | | | | | | | | | | | | | | | | | | | | | | | | | | | | | | | | | | | | | | | | | | | | | | | | | | | | | | | | | | | | | | | | | | | |
| | | | NW: DFN2020(WF) | | | | | | | | | | | | | | | | | | | | | | | | | | | | | | | | | | | | | | | | | | | | | | | | | | | | | | | | | | | | | | | | | | | | | | |
| | | 10-pin | L: Chip LGA | | | | | | | | | | | | | | | | | | | | | | | | | | | | | | | | | | | | | | | | | | | | | | | | | | | | | | | | | | | | | | | | | | | | | | |
| | | | (TCSPAC-153001) | | | | | | | | | | | | | | | | | | | | | | | | | | | | | | | | | | | | | | | | | | | | | | | | | | | | | | | | | | | | | | | | | | | | | | |
| | | | (TCSPAG-341501) | | | | | | | | | | | | | | | | | | | | | | | | | | | | | | | | | | | | | | | | | | | | | | | | | | | | | | | | | | | | | | | | | | | | | | |
| | | 14-pin | L: Chip LGA | | | | | | | | | | | | | | | | | | | | | | | | | | | | | | | | | | | | | | | | | | | | | | | | | | | | | | | | | | | | | | | | | | | | | | |
| | | | (TCSPED-302701) | | | | | | | | | | | | | | | | | | | | | | | | | | | | | | | | | | | | | | | | | | | | | | | | | | | | | | | | | | | | | | | | | | | | | | |

6. Device Packages

Surface Mount Type (Lead Type)

VESM (SOT-723) (1.2 x 1.2)	SSM (SOT-416) (1.6 x 1.6)	UFM (SOT-323F) (2.0 x 2.1)
<p>Package dimension unit: mm</p>	<p>Package dimension unit: mm</p>	<p>Package dimension unit: mm</p>
<p>Land pattern example unit: mm</p>	<p>Land pattern example unit: mm</p>	<p>Land pattern example unit: mm</p>
USM (SOT-323) (2.0 x 2.1)	SOT23 (SOT-23) (2.9 x 2.4)	SOT-23F (2.9 x 2.4)
<p>Package dimension unit: mm</p>	<p>Package dimension unit: mm</p>	<p>Package dimension unit: mm</p>
<p>Land pattern example unit: mm</p>	<p>Land pattern example unit: mm</p>	<p>Land pattern example unit: mm</p>
S-Mini (SOT-346) (2.9 x 2.5)	ESV (SOT-553) (1.6 x 1.6)	UFV (SOT-353F) (2.0 x 2.1)
<p>Package dimension unit: mm</p>	<p>Package dimension unit: mm</p>	<p>Package dimension unit: mm</p>
<p>Land pattern example unit: mm</p>	<p>Land pattern example unit: mm</p>	<p>Land pattern example unit: mm</p>

USV (SOT-353) (2.0 x 2.1)	SMV (SOT-25) (2.9 x 2.8)	ES6 (SOT-563) (1.6 x 1.6)
Package dimension unit: mm 	Package dimension unit: mm 	Package dimension unit: mm
Land pattern example unit: mm 	Land pattern example unit: mm 	Land pattern example unit: mm

UF6 (SOT-363F) (2.0 x 2.1)	US6 (SOT-363) (2.0 x 2.1)	TSOP6F (2.9 x 2.8)
Package dimension unit: mm 	Package dimension unit: mm 	Package dimension unit: mm
Land pattern example unit: mm 	Land pattern example unit: mm 	Land pattern example unit: mm

Surface Mount Type (Leadless Type)

SM6 (SOT-26) (2.9 x 2.8)	CST3 (SOT-883) (1.0 x 0.6)	CST3C (0.8 x 0.6)
Package dimension unit: mm 	Package dimension unit: mm 	Package dimension unit: mm
Land pattern example unit: mm 	Land pattern example unit: mm 	Land pattern example unit: mm

UDFN6 (SOT-1118) (2.0 x 2.0)	UDFN6B (SOT-1220) (2.0 x 2.0)	WCSP6C (1.5 x 1.0)
Package dimension unit : mm 	Package dimension unit : mm 	Package dimension unit : mm
Land pattern example unit : mm 	Land pattern example unit : mm 	Land pattern example unit : mm

DFN2020(WF) (2.0 x 2.0)	TCSP6A-172101 (2.14 x 1.67)	TCSPAC-153001 (2.98 x 1.49)
Package dimension unit : mm 	Package dimension unit : mm 	Package dimension unit : mm
Land pattern example unit : mm 	Land pattern example unit : mm 	Land pattern example unit : mm

TCSPED-302701 (3.0 x 2.74)	TCSPAG-341501 (3.37 x 1.47)
Package dimension unit : mm 	Package dimension unit : mm
Land pattern example unit : mm 	Land pattern example unit : mm

II Power MOSFETs

1. Low-Voltage MOSFETs Series



TSN Advance (3.3 x 3.3)

Circuit Configuration	Part Number	Absolute Maximum Ratings			R _{DS(ON)} max (mΩ)									Q _g typ. (nC)		C _{iss} typ. (pF)	Remark
		V _{DS} (V)	V _{GES} (V)	I _D (A)	V _{GES} = 10V	V _{GES} = 8V	V _{GES} = 6.5V	V _{GES} = 6V	V _{GES} = 4.5V	V _{GES} = 2.5V	V _{GES} = 2V	V _{GES} = 1.8V	V _{GES} = 10V	V _{GES} = 4.5V			
N-ch Note(1)	TPN11003NL	30	+/-20	31 ^{SL}	11	-	-	-	16	-	-	-	7.5	3.3	510	U-MOSVIII-H	
	TPN8R903NL	30	+/-20	37 ^{SL}	8.9	-	-	-	12.7	-	-	-	9.8	4.4	630	U-MOSVIII-H	
	TPN6R003NL	30	+/-20	56 ^{SL}	6	-	-	-	8.3	-	-	-	17	8.2	1050	U-MOSVIII-H	
	TPN5R203PL	30	+/-20	76 ^{SL}	5.2	-	-	-	6.4	-	-	-	22	10	1520	U-MOSIX-H	
	TPN4R303NL	30	+/-20	63 ^{SL}	4.3	-	-	-	6.3	-	-	-	14.8	6.8	1110	U-MOSVIII-H	
	TPN2R903PL	30	+/-20	122 ^{SL}	2.9	-	-	-	4.1	-	-	-	26	12	1780	U-MOSIX-H	
	TPN2R703NL	30	+/-20	90 ^{SL}	2.7	-	-	-	4.1	-	-	-	21	9.5	1600	U-MOSVIII-H	
	TPN1R603PL	30	+/-20	188 ^{SL}	1.6	-	-	-	2.5	-	-	-	41	20	2970	U-MOSIX-H	
	TPN7R504PL	40	+/-20	68 ^{SL}	7.5	-	-	-	10	-	-	-	24	12	1570	U-MOSIX-H	
	TPN3R704PL	40	+/-20	92 ^{SL}	3.7	-	-	-	6	-	-	-	27	13.3	1910	U-MOSIX-H	
	TPN2R304PL	40	+/-20	100 ^{SL}	2.3	-	-	-	4	-	-	-	41	19.4	2750	U-MOSIX-H	
	TPN2R805PL	45	+/-20	139 ^{SL}	2.8	-	-	-	5	-	-	-	39	19	2450	U-MOSIX-H	
	TPN22006NH	60	+/-20	21 ^{SL}	22	-	64	-	-	-	-	-	12	-	710	U-MOSVIII-H	
	TPN14006NH	60	+/-20	33 ^{SL}	14	-	41	-	-	-	-	-	15	-	1000	U-MOSVIII-H	
	TPN11006PL	60	+/-20	54 ^{SL}	11.4	-	-	-	18.1	-	-	-	17	9	1250	U-MOSIX-H	
	TPN11006NL	60	+/-20	37 ^{SL}	11.4	-	-	-	17	-	-	-	23	11.2	1500	U-MOSVIII-H	
	TPN7R506NH	60	+/-20	53 ^{SL}	7.5	-	16	-	-	-	-	-	22	-	1410	U-MOSVIII-H	
	TPN7R006PL	60	+/-20	76 ^{SL}	7	-	-	-	13.5	-	-	-	20	9.8	1440	U-MOSIX-H	
	TPN4R806PL	60	+/-20	105 ^{SL}	4.8	-	-	-	9.1	-	-	-	29	14	2130	U-MOSIX-H	
	TPN30008NH	80	+/-20	22 ^{SL}	30	-	-	-	-	-	-	-	11	-	710	U-MOSVIII-H	
	TPN19008QM	80	+/-20	38 ^{SL}	19	-	-	28	-	-	-	-	16	9.7 (@6V)	1020	U-MOSX-H	
	TPN13008NH	80	+/-20	40 ^{SL}	13.3	-	-	-	-	-	-	-	18	-	1230	U-MOSVIII-H	
	TPN12008QM	80	+/-20	60 ^{SL}	12.3	-	-	17.7	-	-	-	-	22	13.9 (@6V)	1280	U-MOSX-H	
	TPN8R408QM	80	+/-20	77 ^{SL}	8.4	-	-	12.4	-	-	-	-	28	17 (@6V)	1750	U-MOSX-H	
	TPN3300ANH	100	+/-20	21 ^{SL}	33	-	-	-	-	-	-	-	11	-	680	U-MOSVIII-H	
	TPN1600ANH	100	+/-20	36 ^{SL}	16	-	-	-	-	-	-	-	19	-	1230	U-MOSVIII-H	
TPN1200APL	100	+/-20	66 ^{SL}	11.5	-	-	-	20	-	-	-	24	12	1425	U-MOSIX-H		
TPN5900CNH	150	+/-20	18 ^{SL}	59	-	-	-	-	-	-	-	7	-	460	U-MOSVIII-H		
TPN4800CQH	150	+/-20	29 ^{SL}	48	59	-	-	-	-	-	-	11	9 (@8V)	800	U-MOSX-H		
TPN1110ENH	200	+/-20	13 ^{SL}	114	-	-	-	-	-	-	-	7	-	460	U-MOSVIII-H		
TPN2010FNH	250	+/-20	9.9 ^{SL}	198	-	-	-	-	-	-	-	7	-	460	U-MOSVIII-H		
N-ch	TPN6R303NC	30	+/-20	43 ^{SL}	6.3	-	-	-	8.4	-	-	-	24	-	1370	U-MOSVIII	
	TPN4R203NC	30	+/-20	53 ^{SL}	4.2	-	-	-	6.4	-	-	-	24	-	1370	U-MOSVIII	
	TPN2R203NC	30	+/-20	100 ^{SL}	2.2	-	-	-	3.6	-	-	-	34	-	2230	U-MOSVIII	
P-ch	TPCC8136	-20	+/-12	-9.4	-	-	-	-	16	22	37	60	-	36 (@5V)	2350	U-MOSVI	
	TPCC8137	-20	+/-12	-13	-	-	-	-	10	16	30	52	-	43 (@5V)	2990	U-MOSVI	
	TPCC8138	-20	+/-12	-18	-	-	-	-	7.5	11	21	42	-	63 (@5V)	4165	U-MOSVI	
	TPN4R712MD	-20	+/-12	-36	-	-	-	-	4.7	8.1	-	-	-	65 (@5V)	4300	U-MOSVI	
	TPCC8131	-30	+20/-25	-10	17.6	-	-	-	-	23	-	-	-	40	-	1700	U-MOSVI
	TPCC8104	-30	+20/-25	-20	8.8	-	-	-	-	12.4	-	-	-	58	-	2260	U-MOSVI
TPCC8105	-30	+20/-25	-23	7.8	-	-	-	-	10.4	-	-	-	76	-	3240	U-MOSVI	

§ With protection Zener diode between gate and source, ^{SL} I_{D(DC)} (Silicon Limit)
Note(1) : High-speed switching type



SOP-8 (5 x 6)

Circuit Configuration	Part Number	Absolute Maximum Ratings			R _{DS(ON)} max (mΩ)		Q _g typ. (nC)		C _{iss} typ. (pF)	Remark
		V _{DSS} (V)	V _{GSS} (V)	I _D (A)	V _{GS} = 10V	V _{GS} = 4.5V	V _{GS} = 10V	V _{GS} = 4.5V		
N-ch Note(1)	TP89R103NL	30	+/-20	15 ^{SL}	9.1	12.9	9.8	4.4	630	U-MOSVIII-H
	TP86R203NL	30	+/-20	19 ^{SL}	6.2	8.5	17	8.2	1050	U-MOSVIII-H
P-ch	TPC8129	-30	+20/-25	-9	22	28	39	-	1650	U-MOSVI
	TPC8125	-30	+20/-25	-10	13	17	64	-	2580	U-MOSVI
	TPC8134	-40	+20/-25	-5	52	66	20	-	890	U-MOSVI
	TPC8132	-40	+20/-25	-7	25	33	34	-	1580	U-MOSVI
	TPC8133	-40	+20/-25	-9	15	18	64	-	2900	U-MOSVI



SOP Advance (5 x 6)

Circuit Configuration	Part Number	Absolute Maximum Ratings			R _{DS(ON)} max (mΩ)						Q _g typ. (nC)		C _{iss} typ. (pF)	Remark
		V _{DSS} (V)	V _{GSS} (V)	I _D (A)	V _{GS} = 10V	V _{GS} = 8V	V _{GS} = 6.5V	V _{GS} = 6V	V _{GS} = 4.5V	V _{GS} = 2.5V	V _{GS} = 10V	V _{GS} = 4.5V		
N-ch Note(1)	TPH11003NL	30	+/-20	32 ^{SL}	11	-	-	-	16	-	7.5	3.3	510	U-MOSVIII-H
	TPH8R903NL	30	+/-20	38 ^{SL}	8.9	-	-	-	12.7	-	9.8	4.4	630	U-MOSVIII-H
	TPH6R003NL	30	+/-20	57 ^{SL}	6	-	-	-	8.3	-	17	8.2	1050	U-MOSVIII-H
	TPH4R803PL	30	+/-20	90 ^{SL}	4.8	-	-	-	6.2	-	22	10	1520	U-MOSIX-H
	TPH4R003NL	30	+/-20	68 ^{SL}	4	-	-	-	6.2	-	14.8	6.8	1110	U-MOSVIII-H
	TPH3R203NL	30	+/-20	84 ^{SL}	3.2	-	-	-	4.7	-	21	9.5	1600	U-MOSVIII-H
	TPH3R003PL	30	+/-20	134 ^{SL}	3	-	-	-	4.2	-	50	24	2940	U-MOSIX-H
	TPH2R903PL	30	+/-20	124 ^{SL}	2.9	-	-	-	4.1	-	26	12	1780	U-MOSIX-H
	TPH2R003PL	30	+/-20	180 ^{SL}	2	-	-	-	2.6	-	86	41	4930	U-MOSIX-H
	TPH1R403NL	¥ 30	+/-20	150 ^{SL}	1.4	-	-	-	2.1	-	46	20	3400	U-MOSVIII-H
	TPHR9203PL	¥ 30	+/-20	280 ^{SL}	0.92	-	-	-	1.29	-	81	38	5800	U-MOSIX-H
	TPHR9003NL	¥ 30	+/-20	220 ^{SL}	0.9	-	-	-	1.4	-	74	32	5300	U-MOSVIII-H
	TPHR6503PL	¥ 30	+/-20	393 ^{SL}	0.65	-	-	-	0.89	-	110	52	7700	U-MOSIX-H
	TPH7R204PL	40	+/-20	72 ^{SL}	7.2	-	-	-	9.7	-	24	12	1570	U-MOSIX-H
	TPH6R004PL	40	+/-20	87 ^{SL}	6	-	-	-	8.4	-	30	15	2100	U-MOSIX-H
	TPH3R704PL	40	+/-20	92	3.7	-	-	-	6	-	27	13.3	1910	U-MOSIX-H
	TPH3R704PC	40	+/-20	118 ^{SL}	3.7	-	-	-	5.8	-	47	23	2780	U-MOSIX-H
	TPH2R104PL	40	+/-20	180 ^{SL}	2.1	-	-	-	3.1	-	78	37	4790	U-MOSIX-H
	TPH1R204PL	¥ 40	+/-20	246 ^{SL}	1.24	-	-	-	2.1	-	74	34	5500	U-MOSIX-H
	TPH1R204PB	40	+/-20	240 ^{SL}	1.2	-	-	1.96	-	-	62	-	4400	U-MOSIX-H (Low Spike)
	TPHR8504PL	¥ 40	+/-20	340 ^{SL}	0.85	-	-	-	1.4	-	103	49	7370	U-MOSIX-H
	TPHR7404PU	40	+/-20	400 ^{SL}	0.74	-	-	1.17	-	-	98	62 (@6V)	6960	U-MOSIX-H (Low Spike)
	TPH2R805PL	45	+/-20	150 ^{SL}	2.8	-	-	-	3.9	-	73	37	3980	U-MOSIX-H
	TPH1R405PL	45	+/-20	232 ^{SL}	1.4	-	-	-	2.3	-	74	36	4830	U-MOSIX-H
	TPH1R005PL	¥ 45	+/-20	280 ^{SL}	1.04	-	-	-	1.7	-	122	59	7700	U-MOSIX-H
	TPH14006NH	60	+/-20	34 ^{SL}	14	-	33	-	-	-	16	-	1000	U-MOSVIII-H

^{SL} I_D(DC) (Silicon Limit)

¥ The package can be selected according to your preference. For details, please contact your TOSHIBA sales representative.

Note(1) : High-speed switching type

SOP Advance (5 x 6)



Circuit Configuration	Part Number	Absolute Maximum Ratings			R _{DS(ON)} max (mΩ)								Q _g typ. (nC)		C _{iss} typ. (pF)	Remark
		V _{DSS} (V)	V _{GSS} (V)	I _B (A)	V _{GSL} = 10 V	V _{GSL} = 8 V	V _{GSL} = 6.5 V	V _{GSL} = 6 V	V _{GSL} = 4.5 V	V _{GSL} = 2.5 V	V _{GSL} = 10 V	V _{GSL} = 4.5 V				
N-ch Note(1)	TPH11006NL	60	+/-20	40 ^{SL}	11.4	-	-	-	17	-	23	11.2	1500	U-MOSVIII-H		
	TPH9R506PL	60	+/-20	68 ^{SL}	9.5	-	-	-	15	-	21	11	1470	U-MOSIX-H		
	TPH7R506NH	60	+/-20	55 ^{SL}	7.5	-	19	-	-	-	31	-	1785	U-MOSVIII-H		
	TPH7R006PL	60	+/-20	79 ^{SL}	7	-	-	-	13.5	-	22	11	1440	U-MOSIX-H		
	TPH5R906NH	60	+/-20	71 ^{SL}	5.9	-	14	-	-	-	38	-	2340	U-MOSVIII-H		
	TPH4R606NH	60	+/-20	85 ^{SL}	4.6	-	11	-	-	-	49	-	3050	U-MOSVIII-H		
	TPH3R506PL	60	+/-20	135 ^{SL}	3.5	-	-	-	6.7	-	55	27	3400	U-MOSIX-H		
	TPH2R506PL	¥	60	+/-20	160 ^{SL}	2.5	-	-	-	4.4	-	60	32	4180	U-MOSIX-H	
	TPH2R306NH	¥	60	+/-20	130 ^{SL}	2.3	-	4.7	-	-	-	72	-	4700	U-MOSVIII-H	
	TPH1R306PL	¥	60	+/-20	260 ^{SL}	1.34	-	-	-	2.3	-	91	44	6250	U-MOSIX-H	
	TPH1R306P1		60	+/-20	260 ^{SL}	1.28	-	-	-	2.3	-	91	44	6250	U-MOSIX-H (Low Spike)	
	TPH2R608NH		75	+/-20	168 ^{SL}	2.6	-	-	-	-	-	72	-	4600	U-MOSVIII-H	
	TPH12008NH		80	+/-20	44 ^{SL}	12.3	-	-	-	-	-	22	-	1490	U-MOSVIII-H	
	TPH8R008NH		80	+/-20	63 ^{SL}	8	-	-	-	-	-	35	-	2300	U-MOSVIII-H	
	TPH4R008NH	¥	80	+/-20	100 ^{SL}	4	-	-	-	-	-	59	-	4100	U-MOSVIII-H	
	TPH2R408QM	¥	80	+/-20	200 ^{SL}	2.43	-	-	3.5	-	-	87	55 (@6V)	5870	U-MOSX-H	
	TPH1400ANH		100	+/-20	42 ^{SL}	13.6	-	-	-	-	-	22	-	1440	U-MOSVIII-H	
	TPH8R80ANH		100	+/-20	59 ^{SL}	8.8	-	-	-	-	-	33	-	2180	U-MOSVIII-H	
	TPH6R30ANL	§	100	+/-20	66 ^{SL}	6.3	-	-	-	10.3	-	55	27	3300	U-MOSVIII-H	
	TPH5R60APL		100	+/-20	110 ^{SL}	5.6	-	-	-	9.5	-	52	26	3300	U-MOSIX-H	
	TPH4R50ANH	¥	100	+/-20	93 ^{SL}	4.5	-	-	-	-	-	58	-	4000	U-MOSVIII-H	
	TPH4R10ANL		100	+/-20	92 ^{SL}	4.1	-	-	-	6.6	-	75	37	4850	U-MOSVIII-H	
	TPH3R70APL	¥	100	+/-20	150 ^{SL}	3.7	-	-	-	6.2	-	67	33	4850	U-MOSIX-H	
	TPH5900CNH		150	+/-20	18 ^{SL}	59	-	-	-	-	-	7	-	460	U-MOSVIII-H	
	TPH3300CNH		150	+/-20	29 ^{SL}	33	-	-	-	-	-	10.6	-	810	U-MOSVIII-H	
	TPH1500CNH	¥	150	+/-20	50 ^{SL}	15.4	-	-	-	-	-	22	-	1700	U-MOSVIII-H	
TPH9R00CQH	¥	150	+/-20	108 ^{SL}	9	11	-	-	-	-	44	36 (@8V)	3500	U-MOSX-H		
TPH1110ENH		200	+/-20	13 ^{SL}	114	-	-	-	-	-	7	-	460	U-MOSVIII-H		
TPH6400ENH		200	+/-20	21 ^{SL}	64	-	-	-	-	-	11.2	-	810	U-MOSVIII-H		
TPH2900ENH		200	+/-20	36 ^{SL}	29	-	-	-	-	-	22	-	1700	U-MOSVIII-H		
TPH2010FNH		250	+/-20	10 ^{SL}	198	-	-	-	-	-	7	-	460	U-MOSVIII-H		
TPH1110FNH		250	+/-20	15 ^{SL}	112	-	-	-	-	-	11	-	810	U-MOSVIII-H		
TPH5200FNH		250	+/-20	27 ^{SL}	52	-	-	-	-	-	22	-	1700	U-MOSVIII-H		
N-ch	TPHR9003NC	30	+/-20	220 ^{SL}	0.9	-	-	-	1.4	-	75	32	5300	U-MOSVIII		
P-ch	TPH1R712MD	-20	+/-12	-60	-	-	-	-	1.7	2.7	-	182 (@5V)	10900	U-MOSVI		
	TPCA8131	-30	+20/-25	-13	17	-	-	-	22	-	40	-	1700	U-MOSVI		
	TPCA8128	-30	+20/-25	-34	4.8	-	-	-	6.7	-	115	-	4800	U-MOSVI		
	TPCA8120	-30	+20/-25	-45	3	-	-	-	4	-	190	-	7420	U-MOSVI		

^{SL} I_D(DC) (Silicon Limit)

§ With protection Zener diode between gate and source,

¥ The package can be selected according to your preference. For details, please contact your TOSHIBA sales representative.

Note(1) : High-speed switching type



SOP Advance (N) (4.9 x 6.1)

Circuit Configuration	Part Number	Absolute Maximum Ratings			R _{DS(ON)} max (mΩ)						Q _g typ. (nC)		C _{iss} typ. (pF)	R _{th} (ch-c) max (°C/W)	Remark
		V _{DSS} (V)	V _{CESS} (V)	I _D (A)	V _{GS} = 10V	V _{GS} = 8V	V _{GS} = 6.5V	V _{GS} = 6V	V _{GS} = 4.5V	V _{GS} = 2.5V	V _{GS} = 10V	V _{GS} = 4.5V			
N-ch Note(1)	TPH1R403NL1	30	+/-20	230 ^{SL}	1.4	-	-	-	2.1	-	46	20	3400	0.88	U-MOSVIII-H
	TPH1R403NL ¥	30	+/-20	150 ^{SL}	1.4	-	-	-	2.1	-	46	20	3400	1.95	U-MOSVIII-H
	TPHR9203PL1	30	+/-20	320 ^{SL}	0.92	-	-	-	1.29	-	81	38	5800	0.88	U-MOSIX-H
	TPHR9203PL ¥	30	+/-20	280 ^{SL}	0.92	-	-	-	1.29	-	81	38	5800	1.13	U-MOSIX-H
	TPHR9003NL1	30	+/-20	320 ^{SL}	0.9	-	-	-	1.4	-	74	32	5300	0.71	U-MOSVIII-H
	TPHR9003NL ¥	30	+/-20	220 ^{SL}	0.9	-	-	-	1.4	-	74	32	5300	1.6	U-MOSVIII-H
	TPHR6503PL1	30	+/-20	420 ^{SL}	0.65	-	-	-	0.89	-	110	52	7700	0.71	U-MOSIX-H
	TPHR6503PL ¥	30	+/-20	393 ^{SL}	0.65	-	-	-	0.89	-	110	52	7700	0.88	U-MOSIX-H
	TPH1R204PL1	40	+/-20	270 ^{SL}	1.24	-	-	-	2.1	-	74	34	5500	0.88	U-MOSIX-H
	TPH1R204PL ¥	40	+/-20	246 ^{SL}	1.24	-	-	-	2.1	-	74	34	5500	1.13	U-MOSIX-H
	TPHR8504PL1	40	+/-20	370 ^{SL}	0.85	-	-	-	1.4	-	103	49	7370	0.71	U-MOSIX-H
	TPHR8504PL ¥	40	+/-20	340 ^{SL}	0.85	-	-	-	1.4	-	103	49	7370	0.88	U-MOSIX-H
	TPH1R005PL ¥	45	+/-20	280 ^{SL}	1.04	-	-	-	1.7	-	122	59	7700	0.88	U-MOSIX-H
	TPH2R506PL ¥	60	+/-20	160 ^{SL}	2.5	-	-	-	4.4	-	60	32	4180	1.13	U-MOSIX-H
	TPH2R306PL1	60	+/-20	190 ^{SL}	2.3	-	-	-	4.2	-	60	32	4180	0.88	U-MOSIX-H
	TPH2R306NH1	60	+/-20	190 ^{SL}	2.3	-	4.7	-	-	-	72	-	4700	0.71	U-MOSVIII-H
	TPH2R306NH ¥	60	+/-20	130 ^{SL}	2.3	-	4.7	-	-	-	72	-	4700	1.6	U-MOSVIII-H
	TPH1R306PL1	60	+/-20	280 ^{SL}	1.34	-	-	-	2.3	-	91	44	6250	0.71	U-MOSIX-H
	TPH1R306PL ¥	60	+/-20	260 ^{SL}	1.34	-	-	-	2.3	-	91	44	6250	0.88	U-MOSIX-H
	TPH8R808QM	80	+/-20	79 ^{SL}	8.8	-	-	12.5	-	-	26	16 (@6V)	1750	1.37	U-MOSX-H
	TPH6R008QM	80	+/-20	107 ^{SL}	6	-	-	8.4	-	-	38	30 (@6V)	2500	1.11	U-MOSX-H
	TPH4R008QM	80	+/-20	140 ^{SL}	4	-	-	5.6	-	-	57	35 (@6V)	3750	0.88	U-MOSX-H
	TPH4R008NH1	80	+/-20	146 ^{SL}	4	-	-	-	-	-	59	-	4100	0.71	U-MOSVIII-H
	TPH4R008NH ¥	80	+/-20	100 ^{SL}	4	-	-	-	-	-	59	-	4100	1.6	U-MOSVIII-H
	TPH3R008QM	80	+/-20	170 ^{SL}	3	-	-	4.3	-	-	71	44 (@6V)	5090	0.8	U-MOSX-H
	TPH2R408QM ¥	80	+/-20	200 ^{SL}	2.43	-	-	3.5	-	-	87	55 (@6V)	5870	0.71	U-MOSX-H
	TPH4R50ANH1	100	+/-20	138 ^{SL}	4.5	-	-	-	-	-	58	-	4000	0.71	U-MOSVIII-H
	TPH4R50ANH ¥	100	+/-20	93 ^{SL}	4.5	-	-	-	-	-	58	-	4000	1.6	U-MOSVIII-H
	TPH3R70APL1	100	+/-20	170 ^{SL}	3.7	-	-	-	6.2	-	67	33	4850	0.71	U-MOSIX-H
	TPH3R70APL ¥	100	+/-20	150 ^{SL}	3.7	-	-	-	6.2	-	67	33	4850	0.88	U-MOSIX-H
	TPH3R10AQM	100	+/-20	180 ^{SL}	3.1	-	-	6	-	-	83	53 (@6V)	5180	0.71	U-MOSX-H
	TPH1500CNH1	150	+/-20	74 ^{SL}	15.4	-	-	-	-	-	22	-	1700	0.71	U-MOSVIII-H
	TPH1500CNH ¥	150	+/-20	50 ^{SL}	15.4	-	-	-	-	-	22	-	1700	1.6	U-MOSVIII-H
	TPH1400CQH	150	+/-20	77 ^{SL}	14.1	17.3	-	-	-	-	31	25 (@8V)	2400	0.88	U-MOSX-H
	TPH1400CQ5 ☆	150	+/-20	77 ^{SL}	14.1	17.3	-	-	-	-	31	25 (@8V)	2400	0.88	U-MOSX-H (HSD)
	TPH1100CQ5 ☆	150	+/-20	90 ^{SL}	11.1	13.6	-	-	-	-	38	31 (@8V)	2830	0.8	U-MOSX-H (HSD)
	TPH9R00CQH ¥	150	+/-20	108 ^{SL}	9	11	-	-	-	-	44	36 (@8V)	3500	0.71	U-MOSX-H
	TPH9R00CQ5	150	+/-20	108 ^{SL}	9	11	-	-	-	-	44	36 (@8V)	3500	0.71	U-MOSX-H (HSD)

^{SL} I_D(DC) (Silicon Limit)

¥ The package can be selected according to your preference. For details, please contact your TOSHIBA sales representative.

Note(1) : High-speed switching type

☆ New Products, & High Speed Diode type

DSOP Advance (5 x 6)



Circuit Configuration	Part Number	Absolute Maximum Ratings			R _{DS(ON)} max (mΩ)		Q _g typ. (nC)		C _{iss} typ. (pF)	Remark
		V _{DSS} (V)	V _{GSS} (V)	I _D (A)	V _{GS} = 10 V	V _{GS} = 4.5 V	V _{GS} = 10 V	V _{GS} = 4.5 V		
N-ch Note(1)	TPWR8503NL	30	+/-20	300 ^{SL}	0.85	1.3	74	32	5300	U-MOSVIII-H
	TPWR6003PL	30	+/-20	412 ^{SL}	0.6	0.84	110	52	7700	U-MOSIX-H
	TPWR8004PL	40	+/-20	340 ^{SL}	0.8	1.35	103	49	7370	U-MOSIX-H
	TPW1R005PL	45	+/-20	300 ^{SL}	0.99	1.65	122	59	7700	U-MOSIX-H
	TPW1R306PL	60	+/-20	260 ^{SL}	1.29	2.3	91	44	6250	U-MOSIX-H
	TPW2R508NH	75	+/-20	170 ^{SL}	2.5	-	72	-	4600	U-MOSVIII-H
	TPWAR008NH	80	+/-20	116	4	-	59	-	4100	U-MOSVIII-H
	TPW4R50ANH	100	+/-20	92	4.5	-	58	-	4000	U-MOSVIII-H
	TPW3R70APL	100	+/-20	150 ^{SL}	3.7	6.2	67	33	4850	U-MOSIX-H
	TPW1500CNH	150	+/-20	50 ^{SL}	15.4	-	22	-	1700	U-MOSVIII-H
TPW2900ENH	200	+/-20	36 ^{SL}	29	-	22	-	1700	U-MOSVIII-H	
TPW5200FNH	250	+/-20	27 ^{SL}	52	-	22	-	1700	U-MOSVIII-H	

DPAK



Circuit Configuration	Part Number	Absolute Maximum Ratings			R _{DS(ON)} max (mΩ)			Q _g typ. (nC)		C _{iss} typ. (pF)	Remark
		V _{DSS} (V)	V _{GSS} (V)	I _D (A)	V _{GS} = 10 V	V _{GS} = 6 V	V _{GS} = 4.5 V	V _{GS} = 10 V	V _{GS} = 4.5 V		
N-ch Note(1)	TK3R1P04PL	40	+/-20	130 ^{SL}	3.1	-	4.3	60	30	4670	U-MOSIX-H
	TK6R7P06PL	60	+/-20	74 ^{SL}	6.7	-	11.1	26	13	1990	U-MOSIX-H
	TK4R4P06PL	60	+/-20	106 ^{SL}	4.4	-	7.1	48.2	23.9	3280	U-MOSIX-H
	TK6R9P08QM	80	+/-20	83 ^{SL}	6.9	9.6	-	39	24 (@6 V)	2700	U-MOSX-H
	TK5R1P08QM	80	+/-20	105 ^{SL}	5.1	7	-	56	34 (@6 V)	3980	U-MOSX-H
	TK110P10PL	100	+/-20	60 ^{SL}	10.6	-	16	33	17	2040	U-MOSIX-H
	TK7R7P10PL	100	+/-20	79 ^{SL}	7.7	-	11.5	44	21	2800	U-MOSIX-H
P-ch	TJ15P04M3	-40	+/-20	-15	36	-	48	26	-	1100	U-MOSVI

^{SL} I_{D(PC)} (Silicon Limit)

Note(1) : High-speed switching type



TO-220

Circuit Configuration	Part Number	Absolute Maximum Ratings			R _{DS(ON)} max (mΩ)				Q _g typ. (nC)		C _{iss} typ. (pF)	Remark
		V _{DSS} (V)	V _{GSS} (V)	I _D (A)	V _{Gs} = 10 V	V _{Gs} = 8 V	V _{Gs} = 6 V	V _{Gs} = 4.5 V	V _{Gs} = 10 V	V _{Gs} = 4.5 V		
N-ch Note(1)	TK3R1E04PL	40	+/-20	128 ^{SL}	3.1	-	-	3.8	63.4	29.7	4670	U-MOSIX-H
	TK30E06N1	60	+/-20	43 ^{SL}	15	-	-	-	16	-	1050	U-MOSVIII-H
	TK40E06N1	60	+/-20	60 ^{SL}	10.4	-	-	-	23	-	1700	U-MOSVIII-H
	TK8R2E06PL	60	+/-20	75 ^{SL}	8.2	-	-	11.4	28	15	1990	U-MOSIX-H
	TK58E06N1	60	+/-20	105 ^{SL}	5.4	-	-	-	46	-	3400	U-MOSVIII-H
	TK5R1E06PL	60	+/-20	98 ^{SL}	5.1	-	-	8.8	36	18	2380	U-MOSIX-H
	TK4R3E06PL	60	+/-20	106 ^{SL}	4.3	-	-	7.2	48.2	23.9	3280	U-MOSIX-H
	TK3R2E06PL	60	+/-20	160 ^{SL}	3.2	-	-	4.7	71	35	5000	U-MOSIX-H
	TK100E06N1	60	+/-20	263 ^{SL}	2.3	-	-	-	140	-	10500	U-MOSVIII-H
	TK7R0E08QM	80	+/-20	82 ^{SL}	7	-	9.7	-	39	24 (@6 V)	2700	U-MOSX-H
	TK5R3E08QM	80	+/-20	126 ^{SL}	5.3	-	7.3	-	55	33 (@6 V)	3980	U-MOSX-H
	TK3R3E08QM	80	+/-20	200 ^{SL}	3.3	-	4.2	-	110	67 (@6 V)	7670	U-MOSX-H
	TK2R4E08QM	80	+/-20	290 ^{SL}	2.44	-	3.2	-	178	109 (@6 V)	13000	U-MOSX-H
	TK22E10N1	100	+/-20	52 ^{SL}	13.8	-	-	-	28	-	1800	U-MOSVIII-H
	TK110E10PL	100	+/-20	64 ^{SL}	10.7	-	-	16	33	17	2040	U-MOSIX-H
	TK34E10N1	100	+/-20	75 ^{SL}	9.5	-	-	-	38	-	2600	U-MOSVIII-H
	TK40E10N1	100	+/-20	90 ^{SL}	8.2	-	-	-	49	-	3000	U-MOSVIII-H
	TK7R2E10PL	100	+/-20	94 ^{SL}	7.2	-	-	11	44	21	2800	U-MOSIX-H
	TK6R4E10PL	100	+/-20	112 ^{SL}	6.4	-	-	9.7	58	30	3455	U-MOSIX-H
	TK65E10N1	100	+/-20	148 ^{SL}	4.8	-	-	-	81	-	5400	U-MOSVIII-H
	TK3R9E10PL	100	+/-20	180 ^{SL}	3.9	-	-	5.8	96	49	6320	U-MOSIX-H
	TK100E10N1	100	+/-20	207 ^{SL}	3.4	-	-	-	140	-	8800	U-MOSVIII-H
	TK2R9E10PL	100	+/-20	240 ^{SL}	2.9	-	-	4.1	161	83	9500	U-MOSIX-H
	TK32E12N1	120	+/-20	60 ^{SL}	13.8	-	-	-	34	-	2000	U-MOSVIII-H
	TK42E12N1	120	+/-20	88 ^{SL}	9.4	-	-	-	52	-	3100	U-MOSVIII-H
	TK56E12N1	120	+/-20	112 ^{SL}	7	-	-	-	69	-	4200	U-MOSVIII-H
	TK72E12N1	120	+/-20	179 ^{SL}	4.4	-	-	-	130	-	8100	U-MOSVIII-H
	TK9R6E15Q5 ★	150	+/-20	(52)	(9.6)	(11.5)	-	-	(50)	(40 (@8 V))	(3690)	U-MOSX-H (HSD)
	TK7R2E15Q5 ★	150	+/-20	(84)	(7.2)	(8.7)	-	-	(66)	(54 (@8 V))	(4970)	U-MOSX-H (HSD)
	TK4R9E15Q5 ★	150	+/-20	(120)	(4.9)	(5.9)	-	-	(96)	(78 (@8 V))	(7820)	U-MOSX-H (HSD)

^{SL} I_D(DC) (Silicon Limit)

Note(1) : High-speed switching type

★ Under Development (The specification is subject to change without notice.)

TO-220SIS



Circuit Configuration	Part Number	Absolute Maximum Ratings			R _{DS(ON)} max (mΩ)				Q _g typ. (nC)		C _{iss} typ. (pF)	Remark
		V _{DSS} (V)	V _{GSS} (V)	I _D (A)	V _{GS} = 10 V	V _{GS} = 8 V	V _{GS} = 6 V	V _{GS} = 4.5 V	V _{GS} = 10 V	V _{GS} = 4.5 V		
N-ch Note(1)	TK3R1A04PL	40	+/-20	82	3.1	-	-	3.8	63.4	29.7	4670	U-MOSIX-H
	TK30A06N1	60	+/-20	43 ^{SL}	15	-	-	-	16	-	1050	U-MOSVIII-H
	TK40A06N1	60	+/-20	60 ^{SL}	10.4	-	-	-	23	-	1700	U-MOSVIII-H
	TK8R2A06PL	60	+/-20	50	8.2	-	-	11.4	28	15	1990	U-MOSIX-H
	TK58A06N1	60	+/-20	105 ^{SL}	5.4	-	-	-	46	-	3400	U-MOSVIII-H
	TK5R3A06PL	60	+/-20	62 ^{SL}	5.3	-	-	9.3	36	18	2380	U-MOSIX-H
	TK4R3A06PL	60	+/-20	68	4.3	-	-	7.2	48.2	23.9	3280	U-MOSIX-H
	TK3R3A06PL	60	+/-20	88 ^{SL}	3.3	-	-	4.9	71	35	5000	U-MOSIX-H
	TK100A06N1	60	+/-20	263 ^{SL}	2.7	-	-	-	140	-	10500	U-MOSVIII-H
	TK6R8A08QM	80	+/-20	58	6.8	-	9.5	-	39	23 (@6 V)	2700	U-MOSX-H
	TK5R1A08QM	80	+/-20	71 ^{SL}	5.1	-	7.1	-	54	32 (@6 V)	3980	U-MOSX-H
	TK3R2A08QM	80	+/-20	92	3.2	-	4.1	-	102	58 (@6 V)	7670	U-MOSX-H
	TK2R4A08QM	80	+/-20	116 ^{SL}	2.44	-	3.1	-	179	102 (@6 V)	13000	U-MOSX-H
	TK22A10N1	100	+/-20	52 ^{SL}	13.8	-	-	-	28	-	1800	U-MOSVIII-H
	TK110A10PL	100	+/-20	41 ^{SL}	10.8	-	-	16	33	17	2040	U-MOSIX-H
	TK34A10N1	100	+/-20	75 ^{SL}	9.5	-	-	-	38	-	2600	U-MOSVIII-H
	TK40A10N1	100	+/-20	90 ^{SL}	8.2	-	-	-	49	-	3000	U-MOSVIII-H
	TK7R4A10PL	100	+/-20	50	7.4	-	-	11.2	44	21	2800	U-MOSIX-H
	TK6R7A10PL	100	+/-20	56	6.7	-	-	10.1	58	30	3455	U-MOSIX-H
	TK65A10N1	100	+/-20	148 ^{SL}	4.8	-	-	-	81	-	5400	U-MOSVIII-H
	TK4R1A10PL	100	+/-20	85 ^{SL}	4.1	-	-	5.9	104	53	6320	U-MOSIX-H
	TK100A10N1	100	+/-20	207 ^{SL}	3.8	-	-	-	140	-	8800	U-MOSVIII-H
	TK3R2A10PL	100	+/-20	106 ^{SL}	3.2	-	-	4.3	161	83	9500	U-MOSIX-H
	TK32A12N1	120	+/-20	60 ^{SL}	13.8	-	-	-	34	-	2000	U-MOSVIII-H
	TK42A12N1	120	+/-20	88 ^{SL}	9.4	-	-	-	52	-	3100	U-MOSVIII-H
	TK56A12N1	120	+/-20	112 ^{SL}	7.5	-	-	-	69	-	4200	U-MOSVIII-H
	TK72A12N1	120	+/-20	179 ^{SL}	4.5	-	-	-	130	-	8100	U-MOSVIII-H
	TK9R7A15Q5 ★	150	+/-20	(49)	(9.7)	(11.6)	-	-	(50)	(40 (@8 V))	(3690)	U-MOSX-H (HSD)
	TK7R4A15Q5 ★	150	+/-20	(57)	(7.4)	(8.8)	-	-	(66)	(54 (@8 V))	(4970)	U-MOSX-H (HSD)
	TK5R0A15Q5 ★	150	+/-20	(76)	(5)	(6)	-	-	(96)	(78 (@8 V))	(7820)	U-MOSX-H (HSD)

^{SL} I_{D(DC)} (Silicon Limit)

Note(1) : High-speed switching type

★ Under Development (The specification is subject to change without notice.)

2. Mid-High Voltage MOSFETs Series



DPAK / New PW-Mold

Circuit Configuration	Part Number	Absolute Maximum Ratings			R _{DS(ON)} max (Ω)	Q _g typ. (nC)	C _{iss} typ. (pF)	Remark
		V _{DSS} (V)	V _{GSS} (V)	I _D (A)	V _{GS} = 10 V			
N-ch	TK10P50W	500	+/-30	9.7	0.43	20	700	DTMOSIV
	TK12P50W	500	+/-30	11.5	0.34	25	890	DTMOSIV
	TK6P60W	600	+/-30	6.2	0.82	12	390	DTMOSIV
	TK7P60W5 &	600	+/-30	7	0.67	16	490	DTMOSIV(HSD)
	TK7P60W	600	+/-30	7	0.6	15	490	DTMOSIV
	TK560P60Y	600	+/-30	7	0.56	14.5	380	DTMOSV
	TK8P60W5 &	600	+/-30	8	0.56	22	590	DTMOSIV(HSD)
	TK8P60W	600	+/-30	8	0.5	18.5	570	DTMOSIV
	TK10P60W	600	+/-30	9.7	0.43	20	700	DTMOSIV
	TK380P60Y	600	+/-30	9.7	0.38	20	590	DTMOSV
	TK12P60W	600	+/-30	11.5	0.34	25	890	DTMOSIV
	TK290P60Y	600	+/-30	11.5	0.29	25	730	DTMOSV
	TK6P65W	650	+/-30	5.8	1.05	11	390	DTMOSIV
	TK7P65W	650	+/-30	6.8	0.8	15	490	DTMOSIV
	TK8P65W	650	+/-30	7.8	0.67	16	570	DTMOSIV
	TK560P65Y	650	+/-30	7	0.56	14.5	380	DTMOSV
	TK9P65W	650	+/-30	9.3	0.56	20	700	DTMOSIV
	TK11P65W	650	+/-30	11.1	0.44	25	890	DTMOSIV
	TK380P65Y	650	+/-30	9.7	0.38	20	590	DTMOSV
	TK290P65Y	650	+/-30	11.5	0.29	25	730	DTMOSV
N-ch	TK8P25DA	250	+/-20	7.5	0.5	16	550	π-MOSVII
	TK13P25D	250	+/-20	13	0.25	25	1100	π-MOSVII
	TK3P50D	500	+/-30	3	3	7	280	π-MOSVII
	TK4P50D	500	+/-30	4	2	9	380	π-MOSVII
	TK5P50D	500	+/-30	5	1.5	11	490	π-MOSVII
	TK7P50D	500	+/-30	7	1.22	12	600	π-MOSVII
	TK5P53D	525	+/-30	5	1.5	11	540	π-MOSVII
	TK6P53D	525	+/-30	6	1.3	12	600	π-MOSVII
	TK4P55DA	550	+/-30	3.5	2.45	9	380	π-MOSVII
	TK4P55D	550	+/-30	4	1.88	11	490	π-MOSVII
	TK2P60D	600	+/-30	2	4.3	7	280	π-MOSVII
	TK4P60DA	600	+/-30	3.5	2.2	11	490	π-MOSVII
	TK4P60DB	600	+/-30	3.7	2	11	540	π-MOSVII
	TK4P60D	600	+/-30	4	1.7	12	600	π-MOSVII
	TK3P80E	800	+/-30	3	4.9	12	500	π-MOSVIII
	TK2P90E	900	+/-30	2	5.9	12	500	π-MOSVIII

& High Speed Diode type

DFN8x8

Circuit Configuration	Part Number	Absolute Maximum Ratings			R _{DS(ON)} max (Ω)	Q _g typ. (nC)	C _{iss} typ. (pF)	Remark
		V _{DSS} (V)	V _{ESS} (V)	I _O (A)	V _{GS} = 10 V			
N-ch	TK10V60W	600	+/-30	9.7	0.38	20	700	DTMOSIV
	TK12V60W	600	+/-30	11.5	0.3	25	890	DTMOSIV
	TK16V60W5 &	600	+/-30	15.8	0.245	43	1350	DTMOSIV(HSD)
	TK(200)V60Z1 ★	600	+/-30	(15)	(0.2)	(22)	(1200)	DTMOSVI
	TK16V60W	600	+/-30	15.8	0.19	38	1350	DTMOSIV
	TK20V60W5 &	600	+/-30	20	0.19	55	1800	DTMOSIV(HSD)
	TK20V60W	600	+/-30	20	0.17	48	1680	DTMOSIV
	TK165V60Z1 ☆	600	+/-30	16	0.165	24	1350	DTMOSVI
	TK25V60X5 &	600	+/-30	25	0.15	60	2400	DTMOSIV-H(HSD)
	TK25V60X	600	+/-30	25	0.135	40	2400	DTMOSIV-H
	TK130V60Z1 ☆	600	+/-30	18	0.13	28	1620	DTMOSIV
	TK31V60W5 &	600	+/-30	30.8	0.109	105	3000	DTMOSIV(HSD)
	TK(105)V60Z1 ★	600	+/-30	(26)	(0.105)	(39)	(2230)	DTMOSVI
	TK31V60W	600	+/-30	30.8	0.098	86	3000	DTMOSIV
	TK31V60X	600	+/-30	30.8	0.098	65	3000	DTMOSIV-H
	TK085V60Z1 ☆	600	+/-30	30	0.085	43	2510	DTMOSVI
	TK14V65W	650	+/-30	13.7	0.28	35	1300	DTMOSIV
	TK210V65Z	650	+/-30	15	0.21	25	1370	DTMOSVI
	TK17V65W	650	+/-30	17.3	0.21	45	1800	DTMOSIV
	TK200V65Z5 ★ &	650	+/-30	15	0.2	26	1400	DTMOSIV(HSD)
	TK170V65Z	650	+/-30	18	0.17	29	1635	DTMOSVI
	TK22V65X5 &	650	+/-30	22	0.17	50	2400	DTMOSIV-H(HSD)
	TK165V65Z5 ★ &	650	+/-30	18	0.165	30	1660	DTMOSIV(HSD)
	TK28V65W5 &	650	+/-30	27.6	0.14	90	3000	DTMOSIV(HSD)
	TK125V65Z	650	+/-30	24	0.125	40	2250	DTMOSVI
	TK28V65W	650	+/-30	27.6	0.12	75	3000	DTMOSIV
	TK115V65Z5 ☆ &	650	+/-30	23	0.115	42	2280	DTMOSIV(HSD)
	TK099V65Z	650	+/-30	30	0.099	47	2780	DTMOSVI
TK095V65Z5 ☆ &	650	+/-30	28	0.095	50	2880	DTMOSIV(HSD)	

D2PAK

Circuit Configuration	Part Number	Absolute Maximum Ratings			R _{DS(ON)} max (Ω)	Q _g typ. (nC)	C _{iss} typ. (pF)	Remark
		V _{DSS} (V)	V _{ESS} (V)	I _O (A)	V _{GS} = 10 V			
N-ch	TK16G60W5 &	600	+/-30	15.8	0.23	43	1350	DTMOSIV(HSD)
	TK16G60W	600	+/-30	15.8	0.19	38	1350	DTMOSIV
	TK20G60W	600	+/-30	20	0.155	48	1680	DTMOSIV
	TK14G65W5 &	650	+/-30	13.7	0.3	40	1300	DTMOSIV(HSD)
	TK14G65W	650	+/-30	13.7	0.25	35	1300	DTMOSIV

TOLL

Circuit Configuration	Part Number	Absolute Maximum Ratings			R _{DS(ON)} max (Ω)	Q _g typ. (nC)	C _{iss} typ. (pF)	Remark
		V _{DSS} (V)	V _{ESS} (V)	I _O (A)	V _{GS} = 10 V			
N-ch	TK(190)U60Z1 ★	600	+/-30	(15)	(0.19)	(22)	(1200)	DTMOSVI
	TK(155)U60Z1 ★	600	+/-30	(17)	(0.155)	(24)	(1350)	DTMOSVI
	TK(125)U60Z1 ★	600	+/-30	(20)	(0.125)	(28)	(1620)	DTMOSVI
	TK(099)U60Z1 ★	600	+/-30	(26)	(0.099)	(39)	(2230)	DTMOSVI
	TK(080)U60Z1 ★	600	+/-30	(30)	(0.08)	(43)	(2510)	DTMOSVI
	TK055U60Z1	600	+/-30	40	0.055	65	3680	DTMOSVI
	TK(200)U65Z5 ★ &	650	+/-30	(15)	(0.2)	(26)	(1400)	DTMOSIV(HSD)
	TK190U65Z	650	+/-30	15	0.19	25	1370	DTMOSVI
	TK(165)U65Z5 ★ &	650	+/-30	(18)	(0.165)	(30)	(1660)	DTMOSIV(HSD)
	TK155U65Z	650	+/-30	18	0.155	29	1635	DTMOSVI
	TK(115)U65Z5 ★ &	650	+/-30	(24)	(0.115)	(42)	(2280)	DTMOSIV(HSD)
	TK110U65Z	650	+/-30	24	0.11	40	2250	DTMOSVI
	TK(095)U65Z5 ★ &	650	+/-30	(29)	(0.095)	(50)	(2880)	DTMOSIV(HSD)
	TK090U65Z	650	+/-30	30	0.09	47	2780	DTMOSVI
	TK(068)U65Z5 ★ &	650	+/-30	(37)	(0.068)	(68)	(3765)	DTMOSIV(HSD)
	TK065U65Z	650	+/-30	38	0.065	62	3650	DTMOSVI

☆ New Products, & High Speed Diode type

★ Under Development (The specification is subject to change without notice.)



IPAK / New PW-Mold2

Circuit Configuration	Part Number	Absolute Maximum Ratings			R _{DS(ON)} max (Ω)		Q _s typ. (nC)	C _{iss} typ. (pF)	Remark
		V _{DSS} (V)	V _{GSS} (V)	I _D (A)	V _{GS} = 10 V	V _{GS} = 10 V			
N-ch	TK6Q60W	600	+/-30	6.2	0.82	12	390	DTMOSIV	
	TK7Q60W	600	+/-30	7	0.6	15	490	DTMOSIV	
	TK8Q60W	600	+/-30	8	0.5	18.5	570	DTMOSIV	
	TK10Q60W	600	+/-30	9.7	0.43	20	700	DTMOSIV	
	TK12Q60W	600	+/-30	11.5	0.34	25	890	DTMOSIV	
	TK6Q65W	650	+/-30	5.8	1.05	11	390	DTMOSIV	
	TK7Q65W	650	+/-30	6.8	0.8	15	490	DTMOSIV	
	TK8Q65W	650	+/-30	7.8	0.67	16	570	DTMOSIV	
	TK9Q65W	650	+/-30	9.3	0.56	20	700	DTMOSIV	
N-ch	TK11Q65W	650	+/-30	11.1	0.44	25	890	DTMOSIV	
	TK2Q60D	600	+/-30	2	4.3	7	280	π-MOSVII	
	TK4Q60DA	600	+/-30	3.5	2.2	11	490	π-MOSVII	



TO-220

Circuit Configuration	Part Number	Absolute Maximum Ratings			R _{DS(ON)} max (Ω)		Q _s typ. (nC)	C _{iss} typ. (pF)	Remark
		V _{DSS} (V)	V _{GSS} (V)	I _D (A)	V _{GS} = 10 V	V _{GS} = 10 V			
N-ch	TK10E60W	600	+/-30	9.7	0.38	20	700	DTMOSIV	
	TK12E60W	600	+/-30	11.5	0.3	25	890	DTMOSIV	
	TK16E60W5	&	600	+/-30	15.8	0.23	43	1350	DTMOSIV(HSD)
	TK(190)E60Z1	★	600	+/-30	(15)	(0.19)	(22)	(1200)	DTMOSVI
	TK16E60W		600	+/-30	15.8	0.19	38	1350	DTMOSIV
	TK20E60W5	&	600	+/-30	20	0.175	55	1800	DTMOSIV(HSD)
	TK(155)E60Z1	★	600	+/-30	(17)	(0.155)	(24)	(1350)	DTMOSVI
	TK20E60W		600	+/-30	20	0.155	48	1680	DTMOSIV
	TK25E60X5	&	600	+/-30	25	0.14	60	2400	DTMOSIV-H(HSD)
	TK(125)E60Z1	★	600	+/-30	(20)	(0.125)	(28)	(1620)	DTMOSVI
	TK25E60X		600	+/-30	25	0.125	40	2400	DTMOSIV-H
	TK(099)E60Z1	★	600	+/-30	(26)	(0.099)	(39)	(2230)	DTMOSVI
	TK31E60W		600	+/-30	30.8	0.088	86	3000	DTMOSIV
	TK31E60X		600	+/-30	30.8	0.088	65	3000	DTMOSIV-H
	TK(080)E60Z1	★	600	+/-30	(30)	(0.08)	(43)	(2510)	DTMOSVI
	TK14E65W5	&	650	+/-30	13.7	0.3	40	1300	DTMOSIV(HSD)
	TK14E65W		650	+/-30	13.7	0.25	35	1300	DTMOSIV
	TK200E65Z5	★ &	650	+/-30	15	0.2	26	1400	DTMOSVI(HSD)
	TK17E65W		650	+/-30	17.3	0.2	45	1800	DTMOSIV
	TK190E65Z	☆	650	+/-30	15	0.19	25	1370	DTMOSVI
	TK165E65Z5	★ &	650	+/-30	18	0.165	30	1660	DTMOSVI(HSD)
	TK155E65Z	☆	650	+/-30	18	0.155	29	1635	DTMOSVI
	TK115E65Z5	☆ &	650	+/-30	24	0.115	42	2280	DTMOSVI(HSD)
	TK110E65Z	☆	650	+/-30	24	0.11	40	2250	DTMOSVI
	TK28E65W		650	+/-30	27.6	0.11	75	3000	DTMOSIV
	TK095E65Z5	☆ &	650	+/-30	29	0.095	50	2880	DTMOSVI(HSD)
	TK090E65Z	☆	650	+/-30	30	0.09	47	2780	DTMOSVI
	TK7E80W		800	+/-20	6.5	0.95	13	700	DTMOSIV
	TK10E80W		800	+/-20	9.5	0.55	19	1150	DTMOSIV
	TK12E80W		800	+/-20	11.5	0.45	23	1400	DTMOSIV
	TK17E80W		800	+/-20	17	0.29	32	2050	DTMOSIV
	N-ch	TK13E25D	250	+/-20	13	0.25	25	1100	π-MOSVII

☆ New Products, & High Speed Diode type

★ Under Development (The specification is subject to change without notice.)

TO-220SIS



Circuit Configuration	Part Number	Absolute Maximum Ratings			R _{DS(ON)} max (Ω)	Q _g typ. (nC)	C _{iss} typ. (pF)	Remark
		V _{DSS} (V)	V _{CESS} (V)	I _B (A)	V _{ES} = 10 V			
N-ch	TK10A50W	500	+/-30	9.7	0.38	20	700	DTMOSIV
	TK12A50W	500	+/-30	11.5	0.3	25	890	DTMOSIV
	TK19A50W	500	+/-30	18.5	0.19	38	1350	DTMOSIV
	TK6A60W	600	+/-30	6.2	0.75	12	390	DTMOSIV
	TK7A60W5 &	600	+/-30	7	0.65	16	490	DTMOSIV(HSD)
	TK7A60W	600	+/-30	7	0.6	15	490	DTMOSIV
	TK560A60Y	600	+/-30	7	0.56	14.5	380	DTMOSV
	TK8A60W5 &	600	+/-30	8	0.54	22	590	DTMOSIV(HSD)
	TK8A60W	600	+/-30	8	0.5	18.5	570	DTMOSIV
	TK10A60W5 &	600	+/-30	9.7	0.45	25	720	DTMOSIV(HSD)
	TK10A60W	600	+/-30	9.7	0.38	20	700	DTMOSIV
	TK380A60Y	600	+/-30	9.7	0.38	20	590	DTMOSV
	TK12A60W	600	+/-30	11.5	0.3	25	890	DTMOSIV
	TK290A60Y	600	+/-30	11.5	0.29	25	730	DTMOSV
	TK16A60W5 &	600	+/-30	15.8	0.23	43	1350	DTMOSIV(HSD)
	TK16A60W	600	+/-30	15.8	0.19	38	1350	DTMOSIV
	TK(190)A60Z1 ★	600	+/-30	(15)	(0.19)	(22)	(1200)	DTMOSVI
	TK20A60W5 &	600	+/-30	20	0.175	55	1800	DTMOSIV(HSD)
	TK155A60Z1 ☆	600	+/-30	17	0.155	24	1350	DTMOSVI
	TK20A60W	600	+/-30	20	0.155	48	1680	DTMOSIV
	TK25A60X5 &	600	+/-30	25	0.14	60	2400	DTMOSIV-H(HSD)
	TK125A60Z1 ☆	600	+/-30	20	0.125	28	1620	DTMOSVI
	TK25A60X	600	+/-30	25	0.125	40	2400	DTMOSIV-H
	TK(099)A60Z1 ★	600	+/-30	(26)	(0.099)	(39)	(2230)	DTMOSVI
	TK31A60W	600	+/-30	30.8	0.088	86	3000	DTMOSIV
	TK080A60Z1 ☆	600	+/-30	30	0.08	43	2510	DTMOSVI
	TK39A60W	600	+/-30	38.8	0.065	110	4100	DTMOSIV
	TK6A65W	650	+/-30	5.8	1	11	390	DTMOSIV
	TK7A65W	650	+/-30	6.8	0.78	15	490	DTMOSIV
	TK8A65W	650	+/-30	7.8	0.65	16	570	DTMOSIV
	TK560A65Y	650	+/-30	7	0.56	14.5	380	DTMOSV
	TK9A65W	650	+/-30	9.3	0.5	20	700	DTMOSIV
	TK11A65W	650	+/-30	11.1	0.39	25	890	DTMOSIV
	TK380A65Y	650	+/-30	9.7	0.38	20	590	DTMOSV
	TK14A65W5 &	650	+/-30	13.7	0.3	40	1300	DTMOSIV(HSD)
	TK290A65Y	650	+/-30	11.5	0.29	25	730	DTMOSV
	TK14A65W	650	+/-30	13.7	0.25	35	1300	DTMOSIV
	TK17A65W5 &	650	+/-30	17.3	0.23	50	1800	DTMOSIV(HSD)
	TK17A65W	650	+/-30	17.3	0.2	45	1800	DTMOSIV
	TK200A65Z5 ★ &	650	+/-30	15	0.2	26	1400	DTMOSIV(HSD)
	TK190A65Z	650	+/-30	15	0.19	25	1370	DTMOSVI
	TK165A65Z5 ★ &	650	+/-30	18	0.165	30	1660	DTMOSIV(HSD)
	TK22A65X5 &	650	+/-30	22	0.16	50	2400	DTMOSIV-H(HSD)
	TK155A65Z	650	+/-30	18	0.155	29	1635	DTMOSVI
	TK22A65X	650	+/-30	22	0.15	50	2400	DTMOSIV-H
	TK115A65Z5 ☆ &	650	+/-30	24	0.115	42	2280	DTMOSIV(HSD)
	TK110A65Z	650	+/-30	24	0.11	40	2250	DTMOSVI
TK28A65W	650	+/-30	27.6	0.11	75	3000	DTMOSIV	
TK095A65Z5 ☆ &	650	+/-30	29	0.095	50	2880	DTMOSIV(HSD)	
TK35A65W5 &	650	+/-30	35	0.095	115	4100	DTMOSIV(HSD)	
TK090A65Z	650	+/-30	30	0.09	47	2780	DTMOSVI	
TK35A65W	650	+/-30	35	0.08	100	4100	DTMOSIV	

☆ New Products, & High Speed Diode type

★ Under Development (The specification is subject to change without notice.)



TO-220SIS

Circuit Configuration	Part Number	Absolute Maximum Ratings			R _{DS(ON)} max (Ω)	Q _g typ. (nC)	C _{iss} typ. (pF)	Remark
		V _{BSS} (V)	V _{GSS} (V)	I _D (A)	V _{GS} = 10 V			
N-ch	TK7A80W	800	+/-20	6.5	0.95	13	700	DTMOSIV
	TK10A80W	800	+/-20	9.5	0.55	19	1150	DTMOSIV
	TK12A80W	800	+/-20	11.5	0.45	23	1400	DTMOSIV
	TK17A80W	800	+/-20	17	0.29	32	2050	DTMOSIV
	TK9A20DA	200	+/-20	8.5	0.4	14	550	π-MOSVII
	TK15A20D	200	+/-20	15	0.18	26	1050	π-MOSVII
	TK20A20D	200	+/-20	20	0.109	43	1650	π-MOSVII
	TK25A20D	200	+/-20	25	0.07	60	2550	π-MOSVII
	TK8A25DA	250	+/-20	7.5	0.5	16	550	π-MOSVII
	TK13A25D	250	+/-20	13	0.25	25	1100	π-MOSVII
	TK17A25D	250	+/-20	17	0.15	43	1650	π-MOSVII
	TK20A25D	250	+/-20	20	0.1	55	2550	π-MOSVII
	TK18A30D	300	+/-20	18	0.139	60	2600	π-MOSVII
	TK5A45DA	450	+/-30	4.5	1.75	9	380	π-MOSVII
	TK6A45DA	450	+/-30	5.5	1.35	11	490	π-MOSVII
	TK7A45DA	450	+/-30	6.5	1.2	11	540	π-MOSVII
	TK8A45D	450	+/-30	8	0.9	16	700	π-MOSVII
	TK9A45D	450	+/-30	9	0.77	16	800	π-MOSVII
	TK11A45D	450	+/-30	11	0.62	20	1050	π-MOSVII
	TK12A45D	450	+/-30	12	0.52	24	1200	π-MOSVII
	TK13A45D	450	+/-30	13	0.46	25	1350	π-MOSVII
	TK19A45D	450	+/-30	19	0.25	45	2600	π-MOSVII
	TK4A50D	500	+/-30	4	2	9	380	π-MOSVII
	TK5A50D	500	+/-30	5	1.5	11	490	π-MOSVII
	TK6A50D	500	+/-30	6	1.4	11	540	π-MOSVII
	TK7A50D	500	+/-30	7	1.22	12	600	π-MOSVII
	TK8A50DA	500	+/-30	7.5	1.04	16	700	π-MOSVII
	TK8A50D	500	+/-30	8	0.85	16	800	π-MOSVII
	TK10A50D	500	+/-30	10	0.72	20	1050	π-MOSVII
	TK11A50D	500	+/-30	11	0.6	24	1200	π-MOSVII
	TK12A50D	500	+/-30	12	0.52	25	1350	π-MOSVII
	TK13A50DA	500	+/-30	12.5	0.47	28	1550	π-MOSVII
	TK13A50D	500	+/-30	13	0.4	38	1800	π-MOSVII
	TK15A50D	500	+/-30	15	0.3	40	2300	π-MOSVII
	TK18A50D	500	+/-30	18	0.27	45	2600	π-MOSVII
	TK4A53D	525	+/-30	4	1.7	11	490	π-MOSVII
	TK5A53D	525	+/-30	5	1.5	11	540	π-MOSVII
	TK6A53D	525	+/-30	6	1.3	12	600	π-MOSVII
	TK12A53D	525	+/-30	12	0.58	25	1350	π-MOSVII
	TK4A55DA	550	+/-30	3.5	2.45	9	380	π-MOSVII
	TK4A55D	550	+/-30	4	1.88	11	490	π-MOSVII
	TK5A55D	550	+/-30	5	1.7	11	540	π-MOSVII
	TK6A55DA	550	+/-30	5.5	1.48	12	600	π-MOSVII
	TK7A55D	550	+/-30	7	1.25	16	700	π-MOSVII
	TK8A55DA	550	+/-30	7.5	1.07	16	800	π-MOSVII

TO-220SIS



Circuit Configuration	Part Number	Absolute Maximum Ratings			R _{DS(ON)} max (Ω)	Q _g typ. (nC)	C _{iss} typ. (pF)	Remark
		V _{DSS} (V)	V _{CESS} (V)	I _D (A)	V _{GS} =10 V			
N-ch	TK9A55DA	550	+/-30	8.5	0.86	20	1050	π-MOSVII
	TK10A55D	550	+/-30	10	0.72	24	1200	π-MOSVII
	TK11A55D	550	+/-30	11	0.63	25	1350	π-MOSVII
	TK12A55D	550	+/-30	12	0.57	28	1550	π-MOSVII
	TK13A55DA	550	+/-30	12.5	0.48	38	1800	π-MOSVII
	TK14A55D	550	+/-30	14	0.37	40	2300	π-MOSVII
	TK16A55D	550	+/-30	16	0.33	45	2600	π-MOSVII
	TK4K1A60F	600	+/-30	2	4.1	8	270	π-MOSIX
	TK3A60DA	600	+/-30	2.5	2.8	9	380	π-MOSVII
	TK2K2A60F	600	+/-30	3.5	2.2	13	450	π-MOSIX
	TK1K9A60F	600	+/-30	3.7	1.9	14	490	π-MOSIX
	TK1K7A60F	600	+/-30	4	1.7	16	560	π-MOSIX
	TK5A60D	600	+/-30	5	1.43	16	700	π-MOSVII
	TK1K2A60F	600	+/-30	6	1.2	21	740	π-MOSIX
	TK1K0A60F	600	+/-30	7.5	1	24	890	π-MOSIX
	TK9A60D	600	+/-30	9	0.83	24	1200	π-MOSVII
	TK750A60F	600	+/-30	10	0.75	30	1130	π-MOSIX
	TK650A60F	600	+/-30	11	0.65	34	1320	π-MOSIX
	TK12A60D	600	+/-30	12	0.55	38	1800	π-MOSVII
	TK430A60F	600	+/-30	13	0.43	48	1940	π-MOSIX
	TK370A60F	600	+/-30	15	0.37	55	2200	π-MOSIX
	TK2A65D	650	+/-30	2	3.26	9	380	π-MOSVII
	TK3A65DA	650	+/-30	2.5	2.51	11	490	π-MOSVII
	TK3A65D	650	+/-30	3	2.25	11	540	π-MOSVII
	TK4A65DA	650	+/-30	3.5	1.9	12	600	π-MOSVII
	TK5A65DA	650	+/-30	4.5	1.67	16	700	π-MOSVII
	TK5A65D	650	+/-30	5	1.43	16	800	π-MOSVII
	TK6A65D	650	+/-30	6	1.11	20	1050	π-MOSVII
	TK7A65D	650	+/-30	7	0.98	24	1200	π-MOSVII
	TK8A65D	650	+/-30	8	0.84	25	1350	π-MOSVII
	TK11A65D	650	+/-30	11	0.7	30	1700	π-MOSVII
	TK12A65D	650	+/-30	12	0.54	40	2300	π-MOSVII
	TK13A65D	650	+/-30	13	0.47	45	2600	π-MOSVII
	TK4A80E	800	+/-30	4	3.5	15	650	π-MOSVIII
	TK5A80E	800	+/-30	5	2.4	20	950	π-MOSVIII
	TK6A80E	800	+/-30	6	1.7	32	1350	π-MOSVIII
	TK10A80E	800	+/-30	10	1	46	2000	π-MOSVIII
	TK3A90E	900	+/-30	2.5	4.6	15	650	π-MOSVIII
	TK5A90E	900	+/-30	4.5	3.1	20	950	π-MOSVIII
	TK7A90E	900	+/-30	7	2	32	1350	π-MOSVIII
TK9A90E	900	+/-30	9	1.3	46	2000	π-MOSVIII	



TO-3P(N)

Circuit Configuration	Part Number	Absolute Maximum Ratings			$R_{DS(ON)}$ max (Ω)	Q_g typ. (nC)	C_{iss} typ. (pF)	Remark
		V_{DSS} (V)	V_{GSS} (V)	I_D (A)	$V_{GS} = 10$ V			
N-ch	TK12J60W	600	+/-30	11.5	0.3	25	890	DTMOSIV
	TK16J60W5 &	600	+/-30	15.8	0.23	43	1350	DTMOSIV(HSD)
	TK16J60W	600	+/-30	15.8	0.19	38	1350	DTMOSIV
	TK20J60W5 &	600	+/-30	20	0.175	55	1800	DTMOSIV(HSD)
	TK20J60W	600	+/-30	20	0.155	48	1680	DTMOSIV
	TK31J60W5 &	600	+/-30	30.8	0.099	105	3000	DTMOSIV(HSD)
	TK31J60W	600	+/-30	30.8	0.088	86	3000	DTMOSIV
	TK39J60W5 &	600	+/-30	38.8	0.074	135	4100	DTMOSIV(HSD)
	TK39J60W	600	+/-30	38.8	0.065	110	4100	DTMOSIV
	TK62J60W5 &	600	+/-30	61.8	0.045	205	6500	DTMOSIV(HSD)
TK62J60W	600	+/-30	61.8	0.04	180	6500	DTMOSIV	
N-ch	TK40J20D	200	+/-20	40	0.044	100	4300	π -MOSVII
	TK70J20D	200	+/-20	70	0.027	160	6950	π -MOSVII
	TK30J25D	250	+/-20	30	0.06	100	4300	π -MOSVII
	TK60J25D	250	+/-20	60	0.038	160	7000	π -MOSVII
	TK50J30D	300	+/-20	50	0.052	160	7000	π -MOSVII
	TK15J50D	500	+/-30	15	0.4	38	1800	π -MOSVII
	TK20J50D	500	+/-30	20	0.27	45	2600	π -MOSVII
	TK12J55D	550	+/-30	12	0.57	28	1550	π -MOSVII
	TK16J55D	550	+/-30	16	0.37	40	2300	π -MOSVII
	TK19J55D	550	+/-30	19	0.33	45	2600	π -MOSVII
	TK10J80E	800	+/-30	10	1	46	2000	π -MOSVIII
	TK7J90E	900	+/-30	7	2	32	1350	π -MOSVIII
TK9J90E	900	+/-30	9	1.3	46	2000	π -MOSVIII	



TO-3P(L)

Circuit Configuration	Part Number	Absolute Maximum Ratings			$R_{DS(ON)}$ max (Ω)	Q_g typ. (nC)	C_{iss} typ. (pF)	Remark
		V_{DSS} (V)	V_{GSS} (V)	I_D (A)	$V_{GS} = 10$ V			
N-ch	TK100L60W	600	+/-30	100	0.018	360	15000	DTMOSIV

& High Speed Diode type

TO-247



Circuit Configuration	Part Number	Absolute Maximum Ratings			R _{DS(ON)} max (Ω)		Q _g typ. (nC)	C _{ISS} typ. (pF)	Remark
		V _{DSS} (V)	V _{CESS} (V)	I _B (A)	V _{GS} = 10 V				
N-ch	TK16N60W5 &	600	+/-30	15.8	0.23	43	1350	DTMOSIV(HSD)	
	TK16N60W	600	+/-30	15.8	0.19	38	1350	DTMOSIV	
	TK20N60W5 &	600	+/-30	20	0.175	55	1800	DTMOSIV(HSD)	
	TK20N60W	600	+/-30	20	0.155	48	1680	DTMOSIV	
	TK25N60X5 &	600	+/-30	25	0.14	60	2400	DTMOSIV-H(HSD)	
	TK125N60Z1 ☆	600	+/-30	20	0.125	28	1620	DTMOSVI	
	TK25N60X	600	+/-30	25	0.125	40	2400	DTMOSIV-H	
	TK(099)N60Z1 ★	600	+/-30	(26)	(0.099)	(39)	(2230)	DTMOSVI	
	TK31N60W5 &	600	+/-30	30.8	0.099	105	3000	DTMOSIV(HSD)	
	TK31N60W	600	+/-30	30.8	0.088	86	3000	DTMOSIV	
	TK31N60X	600	+/-30	30.8	0.088	65	3000	DTMOSIV-H	
	TK080N60Z1 ☆	600	+/-30	30	0.08	43	2510	DTMOSVI	
	TK39N60W5 &	600	+/-30	38.8	0.074	135	4100	DTMOSIV(HSD)	
	TK39N60W	600	+/-30	38.8	0.065	110	4100	DTMOSIV	
	TK39N60X	600	+/-30	38.8	0.065	85	4100	DTMOSIV-H	
	TK(060)N60Z1 ★	600	+/-30	(40)	(0.06)	(57)	(3200)	DTMOSVI	
	TK62N60W5 &	600	+/-30	61.8	0.045	205	6500	DTMOSIV(HSD)	
	TK040N60Z1 ☆	600	+/-30	52	0.04	85	5200	DTMOSVI	
	TK62N60W	600	+/-30	61.8	0.04	180	6500	DTMOSIV	
	TK62N60X	600	+/-30	61.8	0.04	135	6500	DTMOSIV-H	
	TK(024)N60Z1 ★	600	+/-30	(80)	(0.024)	(140)	(8420)	DTMOSVI	
	TK14N65W5 &	650	+/-30	13.7	0.3	40	1300	DTMOSIV(HSD)	
	TK14N65W	650	+/-30	13.7	0.25	35	1300	DTMOSIV	
	TK17N65W	650	+/-30	17.3	0.2	45	1800	DTMOSIV	
	TK28N65W5 &	650	+/-30	27.6	0.13	90	3000	DTMOSIV(HSD)	
	TK115N65Z5 ☆&	650	+/-30	24	0.115	42	2280	DTMOSVI(HSD)	
	TK110N65Z	650	+/-30	24	0.11	40	2250	DTMOSVI	
	TK28N65W	650	+/-30	27.6	0.11	75	3000	DTMOSIV	
	TK095N65Z5 ☆&	650	+/-30	29	0.095	50	2880	DTMOSVI(HSD)	
	TK35N65W5 &	650	+/-30	35	0.095	115	4100	DTMOSIV(HSD)	
TK090N65Z	650	+/-30	30	0.09	47	2780	DTMOSVI		
TK35N65W	650	+/-30	35	0.08	100	4100	DTMOSIV		
TK068N65Z5 ☆&	650	+/-30	37	0.068	68	3765	DTMOSVI(HSD)		
TK065N65Z	650	+/-30	38	0.065	62	3650	DTMOSVI		
TK49N65W5 &	650	+/-30	49.2	0.057	185	6500	DTMOSIV(HSD)		
TK49N65W	650	+/-30	49.2	0.055	160	6500	DTMOSIV		
TK042N65Z5 ☆&	650	+/-30	55	0.042	105	6280	DTMOSVI(HSD)		
TK040N65Z	650	+/-30	57	0.04	105	6250	DTMOSVI		



TO-247-4L

Circuit Configuration	Part Number	Absolute Maximum Ratings			R _{DS(ON)} max (Ω)		Q _g typ. (nC)	C _{ISS} typ. (pF)	Remark
		V _{DSS} (V)	V _{CESS} (V)	I _B (A)	V _{GS} = 10 V				
N-ch	TK25Z60X	600	+/-30	25	0.125	40	2400	DTMOSIV-H	
	TK31Z60X	600	+/-30	30.8	0.088	65	3000	DTMOSIV-H	
	TK39Z60X	600	+/-30	38.8	0.065	85	4100	DTMOSIV-H	
	TK62Z60X	600	+/-30	61.8	0.04	135	6500	DTMOSIV-H	
	TK110Z65Z	650	+/-30	24	0.11	40	2250	DTMOSVI	
	TK090Z65Z	650	+/-30	30	0.09	47	2780	DTMOSVI	
	TK065Z65Z	650	+/-30	38	0.065	62	3650	DTMOSVI	
	TK040Z65Z	650	+/-30	57	0.04	105	6250	DTMOSVI	

☆ New products, & High Speed Diode type

★ Under Development (The specification is subject to change without notice.)

3. Automotive MOSFETs Series



DPAK+

Circuit Configuration	Part Number	Absolute Maximum Ratings			R _{DS(ON)} max (mΩ)			Q _g typ. (nC)	C _{iss} typ. (pF)	Remark
		V _{DS} (V)	V _{GSS} (V)	I _D (A)	V _{GS} = 10 V	V _{GS} = 6 V	V _{GS} = 4.5 V			
N-ch	TK15S04N1L # # \$	40	+/-20	15	17.8	-	37	10	610	U-MOSVIII-H
	TK65S04N1L # # \$	40	+/-20	65	4.3	-	7.8	39	2550	U-MOSVIII-H
	TK100S04N1L #	40	+/-20	100	2.3	-	4.5	76	5490	U-MOSVIII-H
	TK1R4S04PB #	40	+/-20	120	1.35	1.9	-	103	5500	U-MOSIX-H
	TK25S06N1L # # \$	60	+/-20	25	18.5	-	36.8	15	855	U-MOSVIII-H
	TK40S06N1L # # \$	60	+/-20	40	10.5	-	18	26	1650	U-MOSVIII-H
	TK90S06N1L #	60	+/-20	90	3.3	-	5.2	81	5400	U-MOSVIII-H
	TK75S10N1Z # # \$	100	+/-20	7	48	-	-	7.1	470	U-MOSVIII-H
	TK11S10N1L # # \$	100	+/-20	11	28	-	50	15	850	U-MOSVIII-H
	TK33S10N1L # # \$	100	+/-20	33	9.7	-	16.2	33	2250	U-MOSVIII-H
	TK33S10N1Z # # \$	100	+/-20	33	9.7	-	-	28	2050	U-MOSVIII-H
	TK55S10N1 #	100	+/-20	55	6.5	-	-	49	3280	U-MOSVIII-H
TK60S10N1L #	100	+/-20	60	6.11	9.25	-	60	4320	U-MOSVIII-H	
P-ch	TJ10S04M3L # # \$	-40	+10/-20	-10	44	62	-	19	930	U-MOSVI
	TJ20S04M3L # # \$	-40	+10/-20	-20	22.2	32	-	37	1850	U-MOSVI
	TJ40S04M3L # # \$	-40	+10/-20	-40	9.1	13	-	83	4140	U-MOSVI
	TJ60S04M3L # # \$	-40	+10/-20	-60	6.3	9.4	-	125	6510	U-MOSVI
	TJ80S04M3L # # \$	-40	+10/-20	-80	5.2	7.9	-	158	7770	U-MOSVI
	TJ90S04M3L #	-40	+10/-20	-90	4.3	-	6	172	7700	U-MOSVI
	TJ8S06M3L # # \$	-60	+10/-20	-8	104	130	-	19	890	U-MOSVI
	TJ15S06M3L # # \$	-60	+10/-20	-15	50	63	-	36	1770	U-MOSVI
	TJ30S06M3L # # \$	-60	+10/-20	-30	21.8	28	-	80	3950	U-MOSVI
	TJ50S06M3L # # \$	-60	+10/-20	-50	13.8	17.4	-	124	6290	U-MOSVI
	TJ60S06M3L # # \$	-60	+10/-20	-60	11.2	14.5	-	156	7760	U-MOSVI
	TJ15S10M3	-100	+10/-20	-15	130	-	-	69	3200	U-MOSVI

TSON Advance(WF) (3.1 x 3.6)



Circuit Configuration	Part Number	Absolute Maximum Ratings			R _{DS(ON)} max (mΩ)		Q _g typ. (nC)	C _{iss} typ. (pF)	Remark
		V _{DS} (V)	V _{GSS} (V)	I _D (A)	V _{GS} = 10 V	V _{GS} = 4.5 V			
N-ch	XPN7R104NC ◆ # \$	40	+/-20	20	7.1	14.2	21	1290	U-MOSVIII-H
	XPN3R804NC ◆ # \$	40	+/-20	40	3.8	7.8	35	2230	U-MOSVIII-H
	XPN12006NC ◆ # \$	60	+/-20	20	12	23.7	23	1100	U-MOSVIII-H
	XPN6R706NC ◆ # \$	60	+/-20	40	6.7	13.3	35	2000	U-MOSVIII-H
	XPN1300ANC ◆ # \$	100	+/-20	30	13.3	24.2	28	1470	U-MOSVIII-H
P-ch	XPN19014MC ☆◆ # \$	-40	+10/-20	-20	18.7	29.2	51	1600	U-MOSVI
	XPN9R614MC ◆ #	-40	+10/-20	-40	9.6	13.4	64	3000	U-MOSVI

☆ New Products,

AEC-Q101 qualified, \$ With protection Zener diode between gate and source, ◆ Wettable Flank Lead Terminal

SOP Advance(WF) (5 x 6)



Circuit Configuration	Part Number	Absolute Maximum Ratings			R _{DS(ON)} max (mΩ)			Q _g typ. (nC)	C _{ISS} typ. (pF)	Remark
		V _{DSS} (V)	V _{GSS} (V)	I _D (A)	V _{GS} = 10 V	V _{GS} = 6 V	V _{GS} = 4.5 V			
N-ch	XPH3R304PS ◆ #	40	+20/-8	60	3.3	6.3	-	30	1660	U-MOSIX-H
	XPH2R404PS ◆ #	40	+20/-8	90	2.4	4.1	-	40	2500	U-MOSIX-H
	XPH1R104PS ◆ #	40	+/-20	120	1.14	1.96	-	55	4560	U-MOSIX-H
	XPHR9904PS ☆◆ #	40	+/-20	130	0.99	1.63	-	83	5520	U-MOSIX-H
	XPHR7904PS ◆ #	40	+/-20	150	0.79	1.3	-	85	6650	U-MOSIX-H
	XPH3R206NC ◆ # §	60	+/-20	70	3.2	-	6.2	65	4180	U-MOSVIII-H
	XPH2R106NC ◆ #	60	+/-20	110	2.1	-	4.1	104	6900	U-MOSVIII-H
	XPH6R30ANB ◆ # §	100	+/-20	45	6.3	9.5	-	52	3240	U-MOSVIII-H
	XPH4R10ANB ◆ #	100	+/-20	70	4.1	6.2	-	75	4970	U-MOSVIII-H
P-ch	XPH4R714MC ◆ #	-40	+10/-20	-60	4.7	-	6.9	140	5640	U-MOSVI
	XPH3R114MC ◆ #	-40	+10/-20	-100	3.1	-	4.7	230	9500	U-MOSVI
	XPH13016MC ☆◆ #	-60	+10/-20	-60	12.9	-	16.6	148	6820	U-MOSVI
	XPH8R316MC ☆◆ #	-60	+10/-20	-90	8.3	-	10.2	222	10500	U-MOSVI

DSOP Advance(WF) (5 x 6)



Circuit Configuration	Part Number	Absolute Maximum Ratings			R _{DS(ON)} max (mΩ)		Q _g typ. (nC)	C _{ISS} typ. (pF)	Remark
		V _{DSS} (V)	V _{GSS} (V)	I _D (A)	V _{GS} = 10 V	V _{GS} = 6 V			
N-ch	TPW1R104PB * ◆ #	40	+/-20	120	1.14	1.96	55	4560	U-MOSIX-H
	TPWR7904PB ** ◆ #	40	+/-20	150	0.79	1.3	85	6650	U-MOSIX-H
	XPW6R30ANB * ◆ # §	100	+/-20	45	6.3	9.5	52	3240	U-MOSVIII-H
	XPW4R10ANB ** ◆ #	100	+/-20	70	4.1	6.2	75	4970	U-MOSVIII-H

S-TOGL™



Circuit Configuration	Part Number	Absolute Maximum Ratings			R _{DS(ON)} max (mΩ)		Q _g typ. (nC)	C _{ISS} typ. (pF)	Remark
		V _{DSS} (V)	V _{GSS} (V)	I _D (A)	V _{GS} = 10 V	V _{GS} = 6 V			
N-ch	XPJ1R004PB ☆ # %	40	+/-20	160	1	1.8	84	5300	U-MOSIX-H
	XPJR6604PB ☆ # %	40	+/-20	200	0.66	1.16	128	8750	U-MOSIX-H

L-TOGL™



Circuit Configuration	Part Number	Absolute Maximum Ratings			R _{DS(ON)} max (mΩ)		Q _g typ. (nC)	C _{ISS} typ. (pF)	Remark
		V _{DSS} (V)	V _{GSS} (V)	I _D (A)	V _{GS} = 10 V	V _{GS} = 6 V			
N-ch	XPQ1R004PB # %	40	+/-20	200	1	1.8	84	5300	U-MOSIX-H
	XPQR3004PB # %	40	+/-20	400	0.30	0.47	295	20700	U-MOSIX-H
	XPQR8308QB ☆ # %	80	+/-20	350	0.83	1.23	305	19000	U-MOSX-H
	XPQ1R00AQB ☆ # %	100	+/-20	300	1.03	1.93	269	16500	U-MOSX-H

☆ New Products,
 # AEC-Q101 qualified, § With protection Zener diode between gate and source, ◆ Wettable Flank Lead Terminal
 * DSOP Advance(WF)M, ** DSOP Advance(WF)L
 % V_{th} pairing is possible.

4. Silicon Carbide (SiC) MOSFETs Series



TO-247

Circuit Configuration	Part Number	Absolute Maximum Ratings			$R_{DS(ON)}$ typ. (Ω)	Q_g typ. (nC)	C_{iss} typ. (pF)	Remark
		V_{DSS} (V)	V_{GS} (V)	I_D (A)	$V_{GS} = 18$ V			
N-ch	TW107N65C	650	+25/-10	20	0.107	21	600	3rd generation
	TW083N65C	650	+25/-10	30	0.083	28	873	3rd generation
	TW048N65C	650	+25/-10	40	0.048	41	1362	3rd generation
	TW027N65C	650	+25/-10	58	0.027	65	2288	3rd generation
	TW015N65C	650	+25/-10	100	0.015	128	4850	3rd generation
	TW140N120C	1200	+25/-10	20	0.14	24	691	3rd generation
	TW060N120C	1200	+25/-10	36	0.06	46	1530	3rd generation
	TW045N120C	1200	+25/-10	40	0.045	57	1969	3rd generation
	TW030N120C	1200	+25/-10	60	0.03	82	2925	3rd generation
TW015N120C	1200	+25/-10	100	0.015	158	6000	3rd generation	



TO-247-4L(X)

Circuit Configuration	Part Number	Absolute Maximum Ratings			$R_{DS(ON)}$ typ. (Ω)	Q_g typ. (nC)	C_{iss} typ. (pF)	Remark
		V_{DSS} (V)	V_{GS} (V)	I_D (A)	$V_{GS} = 18$ V			
N-ch	TW107Z65C ☆	650	+25/-10	20	0.107	21	600	3rd generation
	TW083Z65C ☆	650	+25/-10	30	0.083	28	873	3rd generation
	TW048Z65C ☆	650	+25/-10	40	0.048	41	1362	3rd generation
	TW027Z65C ☆	650	+25/-10	58	0.027	65	2288	3rd generation
	TW015Z65C ☆	650	+25/-10	100	0.015	128	4850	3rd generation
	TW140Z120C ☆	1200	+25/-10	20	0.14	24	691	3rd generation
	TW060Z120C ☆	1200	+25/-10	36	0.06	46	1530	3rd generation
	TW045Z120C ☆	1200	+25/-10	40	0.045	57	1969	3rd generation
	TW030Z120C ☆	1200	+25/-10	60	0.03	82	2925	3rd generation
	TW015Z120C ☆	1200	+25/-10	100	0.015	158	6000	3rd generation

TOLL



Circuit Configuration	Part Number	Absolute Maximum Ratings			$R_{DS(ON)}$ typ. (Ω)	Q_g typ. (nC)	C_{iss} typ. (pF)	Remark
		V_{DSS} (V)	V_{GS} (V)	I_D (A)	$V_{GS} = 18$ V			
N-ch	TW083U65C ★	650	+25/-10	30	0.083	28	873	3rd generation
	TW048U65C ★	650	+25/-10	40	0.048	41	1362	3rd generation
	TW027U65C ★	650	+25/-10	58	0.027	65	2288	3rd generation
	TW015U65C ★	650	+25/-10	100	0.015	128	4850	3rd generation

DFN8x8



Circuit Configuration	Part Number	Absolute Maximum Ratings			$R_{DS(ON)}$ typ. (Ω)	Q_g typ. (nC)	C_{iss} typ. (pF)	Remark
		V_{DSS} (V)	V_{GS} (V)	I_D (A)	$V_{GS} = 18$ V			
N-ch	TW(120)V65C ★	650	+25/-10	(20)	(0.12)	(21)	(600)	3rd generation
	TW(090)V65C ★	650	+25/-10	(30)	(0.09)	(28)	(873)	3rd generation
	TW(050)V65C ★	650	+25/-10	(40)	(0.05)	(41)	(1362)	3rd generation
	TW(030)V65C ★	650	+25/-10	(58)	(0.03)	(65)	(2288)	3rd generation

☆ New Products

★ Under Development (The specification is subject to change without notice.)

5. Part Naming Conventions

Conventional Multi-Pin Series

Ex.) TPC8 0 67 -H
 ① ② ③ ④

- ① Package
 TPC8: SOP-8 Series
 TPC8: TSON Advance Series TPCA8: SOP Advance Series
- ② Polarity / Configuration
 0: N-channel, single 3: P-channel, dual
 1: P-channel, single 4: N-channel and P-channel, dual
 2: N-channel, dual J: P-channel and NPN
- ③ Serial number of the products
- ④ Additional information
 H: High-speed type None: Low-on-resistance type

New Multi-Pin Series

Ex.) TPH 4R3 0 4 N C 5
 ① ② ③ ④ ⑤ ⑥ ⑦

- ① Package
 TPP: PS-8 Series TPH / XPH: SOP Advance Series
 TPN / XPN: TSON Advance Series TP8: SOP-8 Series
 TPW / XPW: DSOP Advance Series XPQ: L-TOGL™ Series
 XPJ: S-TOGL™ Series
- ② Max. on-resistance (at max drive conditions)
 R79 = 0.79 mΩ 100 = 10 × 10⁰ = 10 mΩ
 4R3 = 4.3 mΩ 101 = 10 × 10¹ = 100 mΩ
- ③ Polarity / Configuration
 0: Single N-ch 1: Single P-ch
- ④ Drain-source voltage (V_{DSS})
 2: 15 to 24 V 7: 65 to 74 V D: 180 to 199 V
 3: 25 to 34 V 8: 75 to 84 V E: 200 to 249 V
 4: 35 to 44 V A: 95 to 124 V F: 250 to 299 V
 5: 45 to 54 V B: 125 to 149 V
 6: 55 to 64 V C: 150 to 179 V
- ⑤ Series
 M: U-MOSVI N: U-MOSVIII / U-MOSVIII-H P: U-MOSIX-H
 Q: U-MOSIX-H
- ⑥ Additional information (1)
 1 to 5: Serial number of the products
 A: V_{GS} = 10 V (Drive)
 B: V_{GS} = 6 V (Drive)
 C: V_{GS} = 4.5 V (Drive)
 D: V_{GS} = 2.5 V (Drive)
 E: V_{GS} = 2.0 V (Drive)
 F: V_{GS} = 1.8 V (Drive)
 H: Low-rg, V_{GS} = 10 V (Drive)
 M: Low-rg, V_{GS} = 6 V (Drive)
 L: Low-rg, V_{GS} = 4.5 V (Drive)
 Q: T_{ch(max)} = Guaranteed up to 175 °C + ZD
 R: T_{ch(max)} = Guaranteed up to 150 °C + ZD
 S: T_{ch(max)} = Guaranteed up to 175 °C
 T: T_{ch(max)} = Guaranteed up to 150 °C
 U: Low spike
- ⑦ Additional information (2)
 5: Fast body diode type

Silicon carbide (SiC) Series

Ex.) TW 107 N 65 C
 ① ② ③ ④ ⑤

- ① Polarity
 TW: N-channel
- ② Typ. on-resistance (at max drive conditions)
 070 = 70 mΩ
- ③ Package
 A: TO-220SIS N: TO-247
 E: TO-220 V: DFN8x8
 J: TO-3P(N) Z: TO-247-4L(X)
- ④ Drain-source voltage V_{DSS}: Display value x 10 times = V_{DSS}
 120: V_{DSS} = 1200 V
- ⑤ Generation
 C: 3rd Generation

3-Pin Series

Ex.) TK 40 S 10 K 3 Z
 ① ② ③ ④ ⑤ ⑥ ⑦

- ① Polarity
 TK: N-channel TJ: P-channel
- ② Drain current (I_b)
- ③ Package
 A: TO-220SIS N: TO-247
 E: TO-220 P: DPAK / New PW-Mold
 F: TO-220SM(W) Q: IPAK / New PW-Mold2
 G: D2PAK S: DPAK+
 J: TO-3P(N) V: DFN8x8
 L: TO-3P(L) Z: TO-247-4L
- ④ Drain-source voltage (V_{DSS}): Display value x 10 = V_{DSS}
 06: V_{DSS} = 60 V 10: V_{DSS} = 100 V
- ⑤ Series
 A: π-MOSIV K: U-MOSIV W: DTMOSIV
 C: π-MOSVI M: U-MOSVI X: DTMOSIV-H
 D: π-MOSVII N: U-MOSVII Z / Z1 / Z5: DTMOSVI
 E: π-MOSVIII U: DTMOS II
 J: U-MOSIII V: DTMOS III
- ⑥ Additional information (1)
 1: Low-capacitance type 5: Fast body diode type
 3: Low-on-resistance type
- ⑦ Additional information (2)
 L: V_{GS} = 4.5 V (Drive) S: V_{GS} = 4.5 V (Drive)
 H: V_{GS} = 10 V (Drive) Z: With protection Zener diode
 M: V_{GS} = 6 V (Drive) between gate and source

New 3-Pin Series

Ex.) TK 1R4 S 04 P B
 ① ② ③ ④ ⑤ ⑥

- ① Polarity
 TK / XK: N-channel TJ / XJ: P-channel
- ② Max. on-resistance V_{DSS} = 400 V less than the product (at max drive conditions)
 R74 = 0.74 mΩ 100 = 10 × 10⁰ = 10 mΩ
 8R2 = 8.2 mΩ 101 = 10 × 10¹ = 100 mΩ
 Max. on-resistance V_{DSS} = 400 V or more products (at max drive conditions)
 047 = 0.047 Ω 410 = 0.41 Ω 4K7 = 4.7 Ω
- ③ Package
 A: TO-220SIS P: DPAK / New PW-Mold
 E: TO-220 Q: IPAK / New PW-Mold2
 G: D2PAK S: DPAK+
 J: TO-3P(N) U: TOLL
 L: TO-3P(L) V: DFN8x8
 N: TO-247 Z: TO-247-4L
- ④ Drain-source voltage V_{DSS}: Display value x 10 times = V_{DSS}
 04: V_{DSS} = 40 V 10: V_{DSS} = 100 V
- ⑤ Series
 F: π-MOSIX N: U-MOSVIII-H Y: DTMOS V
 M: U-MOSVI P: U-MOSIX-H Z: DTMOSVI
- ⑥ Additional information
 A: V_{GS} = 10 V (Drive) H: Low-rg, V_{GS} = 10 V (Drive)
 B: V_{GS} = 6 V (Drive) M: Low-rg, V_{GS} = 6 V (Drive)
 C: V_{GS} = 4.5 V (Drive) L: Low-rg, V_{GS} = 4.5 V (Drive)

JEITA registration Item Series

Ex.) N-channel MOS P-channel MOS
2SK**** **2SJ******

6. Device Packages

Surface Mount Type

DPAK+ (6.5 x 9.5)	New PW-Mold (6.5 x 9.5)	DPAK(2-7K1S) (6.6 x 10.0)
<p>Package dimension unit : mm</p> <p>Bottom View</p>	<p>Package dimension unit : mm</p> <p>Bottom View</p>	<p>Package dimension unit : mm</p> <p>Bottom View</p>
<p>Land pattern example unit : mm</p>	<p>Land pattern example unit : mm</p>	<p>Land pattern example unit : mm</p>

DPAK(2-7N1S)	D2PAK (10.35 x 15.3)	DFN8x8 (8.0 x 8.0)
<p>Package dimension unit : mm</p> <p>Bottom View</p>	<p>Package dimension unit : mm</p> <p>Bottom View</p>	<p>Package dimension unit : mm</p> <p>Bottom View</p>
<p>Land pattern example unit : mm</p>	<p>Land pattern example unit : mm</p>	<p>Land pattern example unit : mm</p>

Surface Mount Type

S-TOGL™ (7.0 x 8.44)		TSON Advance (3.1 x 3.3)		TSON Advance(WF) (3.1 x 3.6) ★		
<p>Package dimension unit : mm</p>	<p>Package dimension unit : mm</p>	<p>Package dimension unit : mm</p>	<p>Package dimension unit : mm</p>	<p>Land pattern example unit : mm</p>	<p>Land pattern example unit : mm</p>	<p>Land pattern example unit : mm</p>

★ Wettable Flank Lead Terminal

SOP-8(2-5R1S) (4.9 x 6.0)		SOP-8(2-6J1S)		DSOP Advance (5.0 x 6.0)		
<p>Package dimension unit : mm</p>	<p>Package dimension unit : mm</p>	<p>Package dimension unit : mm</p>	<p>Package dimension unit : mm</p>	<p>Land pattern example unit : mm</p>	<p>Land pattern example unit : mm</p>	<p>Land pattern example unit : mm</p>

Surface Mount Type

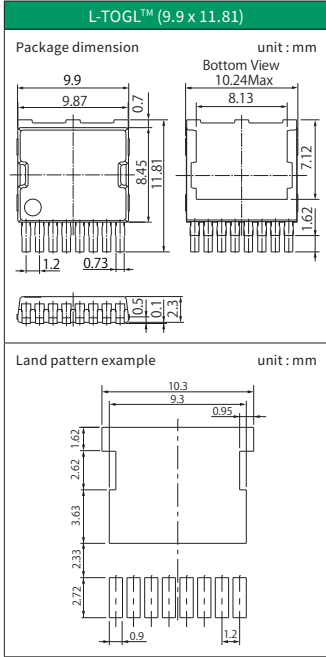

Through Hole Type

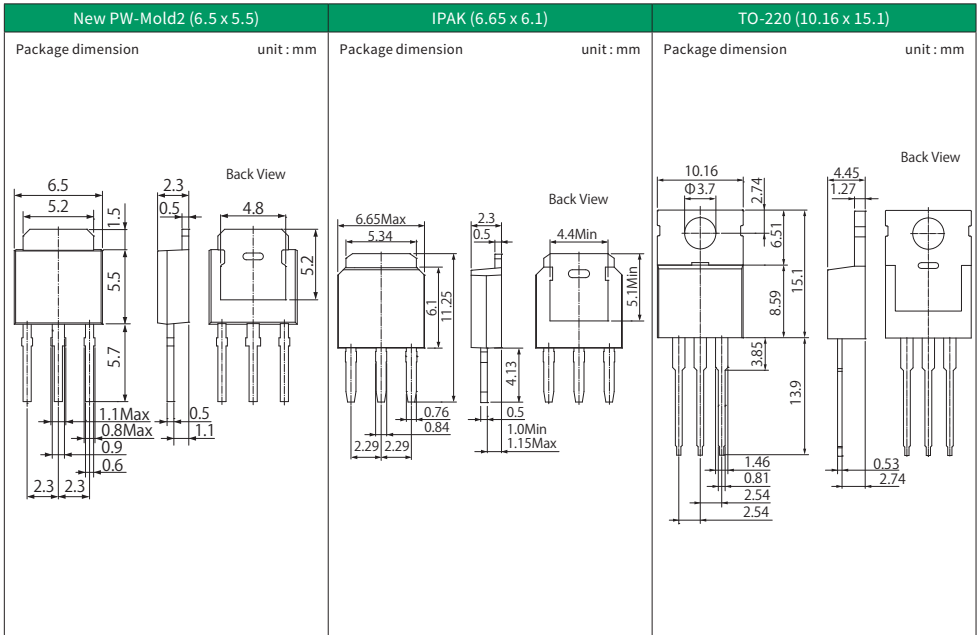

Through Hole Type

TO-220SIS (SC-67) (10.0 x 15.0)		TO-3P(N) (SC-65) (15.5 x 20.0)		TO-247 (15.94 x 20.95)	
Package dimension	unit : mm	Package dimension	unit : mm	Package dimension	unit : mm

TO-3P(L) (20.0 x 26.0)		TO-247-4L (15.94 x 20.95)		TO-247-4L(X) (15.94 x 23.45)	
Package dimension	unit : mm	Package dimension	unit : mm	Package dimension	unit : mm

RESTRICTIONS ON PRODUCT USE

Toshiba Corporation and its subsidiaries and affiliates are collectively referred to as "TOSHIBA". Hardware, software and systems described in this document are collectively referred to as "Product".

- TOSHIBA reserves the right to make changes to the information in this document and related Product without notice.
- This document and any information herein may not be reproduced without prior written permission from TOSHIBA. Even with TOSHIBA's written permission, reproduction is permissible only if reproduction is without alteration/omission.
- Though TOSHIBA works continually to improve Product's quality and reliability, Product can malfunction or fail. Customers are responsible for complying with safety standards and for providing adequate designs and safeguards for their hardware, software and systems which minimize risk and avoid situations in which a malfunction or failure of Product could cause loss of human life, bodily injury or damage to property, including data loss or corruption. Before customers use the Product, create designs including the Product, or incorporate the Product into their own applications, customers must also refer to and comply with (a) the latest versions of all relevant TOSHIBA information, including without limitation, this document, the specifications, the data sheets and application notes for Product and the precautions and conditions set forth in the "TOSHIBA Semiconductor Reliability Handbook" and (b) the instructions for the application with which the Product will be used with or for. Customers are solely responsible for all aspects of their own product design or applications, including but not limited to (a) determining the appropriateness of the use of this Product in such design or applications; (b) evaluating and determining the applicability of any information contained in this document, or in charts, diagrams, programs, algorithms, sample application circuits, or any other referenced documents; and (c) validating all operating parameters for such designs and applications. **TOSHIBA ASSUMES NO LIABILITY FOR CUSTOMERS' PRODUCT DESIGN OR APPLICATIONS.**
- **PRODUCT IS NEITHER INTENDED NOR WARRANTED FOR USE IN EQUIPMENTS OR SYSTEMS THAT REQUIRE EXTRAORDINARILY HIGH LEVELS OF QUALITY AND/OR RELIABILITY, AND/OR A MALFUNCTION OR FAILURE OF WHICH MAY CAUSE LOSS OF HUMAN LIFE, BODILY INJURY, SERIOUS PROPERTY DAMAGE AND/OR SERIOUS PUBLIC IMPACT ("UNINTENDED USE").** Except for specific applications as expressly stated in this document, Unintended Use includes, without limitation, equipment used in nuclear facilities, equipment used in the aerospace industry, lifesaving and/or life supporting medical equipment, equipment used for automobiles, trains, ships and other transportation, traffic signaling equipment, equipment used to control combustions or explosions, safety devices, elevators and escalators, and devices related to power plant. **IF YOU USE PRODUCT FOR UNINTENDED USE, TOSHIBA ASSUMES NO LIABILITY FOR PRODUCT.** For details, please contact your TOSHIBA sales representative or contact us via our website.
- Do not disassemble, analyze, reverse-engineer, alter, modify, translate or copy Product, whether in whole or in part.
- Product shall not be used for or incorporated into any products or systems whose manufacture, use, or sale is prohibited under any applicable laws or regulations.
- The information contained herein is presented only as guidance for Product use. No responsibility is assumed by TOSHIBA for any infringement of patents or any other intellectual property rights of third parties that may result from the use of Product. No license to any intellectual property right is granted by this document, whether express or implied, by estoppel or otherwise.
- **ABSENT A WRITTEN SIGNED AGREEMENT, EXCEPT AS PROVIDED IN THE RELEVANT TERMS AND CONDITIONS OF SALE FOR PRODUCT, AND TO THE MAXIMUM EXTENT ALLOWABLE BY LAW, TOSHIBA (1) ASSUMES NO LIABILITY WHATSOEVER, INCLUDING WITHOUT LIMITATION, INDIRECT, CONSEQUENTIAL, SPECIAL, OR INCIDENTAL DAMAGES OR LOSS, INCLUDING WITHOUT LIMITATION, LOSS OF PROFITS, LOSS OF OPPORTUNITIES, BUSINESS INTERRUPTION AND LOSS OF DATA, AND (2) DISCLAIMS ANY AND ALL EXPRESS OR IMPLIED WARRANTIES AND CONDITIONS RELATED TO SALE, USE OF PRODUCT, OR INFORMATION, INCLUDING WARRANTIES OR CONDITIONS OF MERCHANTABILITY, FITNESS FOR A PARTICULAR PURPOSE, ACCURACY OF INFORMATION, OR NONINFRINGEMENT.**
- Do not use or otherwise make available Product or related software or technology for any military purposes, including without limitation, for the design, development, use, stockpiling or manufacturing of nuclear, chemical, or biological weapons or missile technology products (mass destruction weapons). Product and related software and technology may be controlled under the applicable export laws and regulations including, without limitation, the Japanese Foreign Exchange and Foreign Trade Law and the U.S. Export Administration Regulations. Export and re-export of Product or related software or technology are strictly prohibited except in compliance with all applicable export laws and regulations.
- Please contact your TOSHIBA sales representative for details as to environmental matters such as the RoHS compatibility of Product. Please use in compliance with all applicable laws and regulations that regulate the inclusion or use of controlled substances, including without limitation, the EU RoHS Directive. **TOSHIBA ASSUMES NO LIABILITY FOR DAMAGES OR LOSSES OCCURRING AS A RESULT OF NONCOMPLIANCE WITH APPLICABLE LAWS AND REGULATIONS.**

* S-TOGL™ and L-TOGL™ are trademarks of Toshiba Electronic Devices & Storage Corporation.

TOSHIBA

Toshiba Electronic Devices & Storage Corporation
Toshiba Electronic Device Solutions Corporation

<https://toshiba.semicon-storage.com/>

2024 Rev. 2.0