

The image features the Toshiba logo in red, bold, uppercase letters at the top left. The background is a complex, abstract geometric pattern of white and light blue lines and shapes, creating a sense of depth and movement. The top right corner is divided into three colored sections: blue, yellow, and red. The overall design is modern and technical.

**TOSHIBA**

**Selection Guide 2026**

MOSFETs

# Contents

## **I Small Signal MOSFETs** 3 - 21

- 1. Over 500mA Series MOSFETs (Semi-Power Type) 3 - 10
- 2. Less than 500mA Series MOSFETs (Standard Type) 11 - 14
- 3. MOSFETs with Diode 15
- 4. Small Signal MOSFETs for Automotive 16 - 17
- 5. Part Naming Conventions 18
- 6. Device Packages 19 - 21

## **II Power MOSFETs** 22 - 49

- 1. Low-Voltage MOSFET Series 22 - 29
- 2. Mid-High Voltage MOSFET Series 30 - 38
- 3. Automotive MOSFET Series 39 - 41
- 4. Silicon Carbide (SiC) MOSFET Series 42
- 5. Part Naming Conventions 43
- 6. Device Packages 44 - 48

# I Small Signal MOSFETs

## 1. Over 500mA Series MOSFETs (Semi-Power Type)

Package Dimensions (unit: mm)





CST3C	CST3 (SOT-883)	VESM (SOT-723)	UFM (SOT-323F)	ES6 (SOT-563)	UF6 (SOT-363F)	WCSP6C
Bottom View	Bottom View					Bottom View
0.8 x 0.6	1.0 x 0.6	1.2 x 1.2	2.0 x 2.1	1.6 x 1.6	2.0 x 2.1	1.5 x 1.0

### P-Channel Single MOSFETs

Package	Part Number	V <sub>DS</sub> (V)	V <sub>GS</sub> (V)	I <sub>D</sub> (A)	R <sub>DS(ON)</sub> max (mΩ)						Q <sub>g</sub> typ. (nC)	C <sub>iss</sub> typ. (pF)	Note	
					V <sub>GS</sub> = -1.2 V	V <sub>GS</sub> = -1.5 V	V <sub>GS</sub> = -1.8 V	V <sub>GS</sub> = -2.5 V	V <sub>GS</sub> = -4 V	V <sub>GS</sub> = -4.5 V				V <sub>GS</sub> = -10 V
CST3C	SSM3J64CTC	\$ -12	-/+10	-1	11300	1310	890	560	-	370	-	-	50	
	SSM3J65CTC	\$ -20	-/+10	-0.7	11300	1550	1070	700	-	500	-	-	48	
CST3	SSM3J56ACT	\$ -20	-/+8	-1.4	4000	900	660	480	-	390	-	1.6	100	
	SSM3J76CT ☆	\$ -20	-/+8	-1.4	4000	900	660	480	-	390	-	1.6	100	Low leakage current
	SSM3J65CT ☆	\$ -20	-/+10	-0.7	11300	1550	1070	700	-	500	-	-	48	
VESM	SSM3J66MFV #	\$ -20	-8/+6	-0.8	4000	900	660	480	-	390	-	1.6	100	
	SSM3J56MFV	\$ -20	-/+8	-0.8	4000	900	660	480	-	390	-	1.6	100	
	SSM3J76MFV ☆	\$ -20	-/+8	-0.8	4000	900	660	480	-	390	-	1.6	100	Low leakage current
WCSP6C	SSM6J771G	\$ -20	-/+12	-5	-	-	-	47.5	-	35	34.7 (@-8 V) 31 (@-8.5 V)	9.8	870	
ES6	SSM6J216FE	\$ -12	-/+8	-4.8	-	88.1	56	39.3	-	32	-	12.7	1040	
	SSM6J213FE	\$ -20	-/+8	-2.6	-	250	178	133	-	103	-	4.7	290	
	SSM6J215FE	\$ -20	-/+8	-3.4	-	154	104	79	-	59	-	10.4	630	
	SSM6J212FE	\$ -20	-/+8	-4	-	94	65.4	49	-	40.7	-	14.1	970	
	SSM6J214FE	\$ -30	-/+12	-3.6	-	-	149.6	77.6	-	57	50	7.9	560	
UFM	SSM3J132TU	\$ -12	-/+6	-5.4	94	39	29	21	-	17	-	33	2700	
	SSM3J135TU	\$ -20	-/+8	-3	-	260	180	132	-	103	-	4.6	270	
	SSM3J145TU #	\$ -20	-8/+6	-3	-	260	180	132	-	103	-	4.6	270	
	SSM3J134TU	\$ -20	-/+8	-3.2	-	240	168	123	-	93	-	4.7	290	
	SSM3J144TU #	\$ -20	-8/+6	-3.2	-	240	168	123	-	93	-	4.7	290	
	SSM3J130TU	\$ -20	-/+8	-4.4	-	63.2	41.1	31	-	25.8	-	24.8	1800	
	SSM3J140TU #	\$ -20	-8/+6	-4.4	-	63.2	41.1	31	-	25.8	-	24.8	1800	
	SSM3J133TU	\$ -20	-/+8	-5.5	-	88.4	56	39.7	-	29.8	-	12.8	840	
UF6	SSM6J422TU #	\$ -20	-8/+6	-4	-	99.6	67.8	51.4	-	42.7	-	12.8	840	
	SSM6J412TU	\$ -20	-/+8	-4	-	99.6	67.8	51.4	-	42.7	-	12.8	840	
	SSM6J424TU	\$ -20	-8/+6	-6	-	54	36	26	-	22.5	-	23.1	1650	
	SSM6J414TU	\$ -20	-/+8	-6	-	54	36	26	-	22.5	-	23.1	1650	
	SSM6J402TU	\$ -30	-/+20	-2	-	-	-	-	-	225	-	117	5.3	280

☆ New Products

# AEC-Q101 qualified, \$ With protection Zener diode between gate and source

UDFN6B (SOT-1220)	DFN2020B (WF)	SOT-23F	S-Mini (SOT-346)
Bottom View 	Bottom View 		
2.0 x 2.0	2.0 x 2.0	2.9 x 2.4	2.9 x 2.5

## P-Channel Single MOSFETs

Package	Part Number	V <sub>DSS</sub> (V)	V <sub>GSS</sub> (V)	I <sub>D</sub> (A)	R <sub>Ds(ON)</sub> max (mΩ)						Q <sub>g</sub> typ. (nC)	C <sub>iss</sub> typ. (pF)	Note	
					V <sub>GS</sub> = -1.2 V	V <sub>GS</sub> = -1.5 V	V <sub>GS</sub> = -1.8 V	V <sub>GS</sub> = -2.5 V	V <sub>GS</sub> = -4 V	V <sub>GS</sub> = -4.5 V				V <sub>GS</sub> = -10 V
UDFN6B	SSM6J512NU	\$ -12	-/+10	-10	-	-	40.1	25.7	20.5 (@-3.6 V)	18.7	16.2 (@-8 V)	19.5	1400	
	SSM6J505NU	\$ -12	-/+6	-12	61	30	21	16	-	12	-	37.6	2700	
	SSM6J511NU	\$ -12	-/+10	-14	-	-	19.2	13.5	11.5 (@-3.6 V)	10	9.1 (@-8 V)	47	3350	
	SSM6J503NU	\$ -20	-/+8	-6	-	89.6	57.9	41.7	-	32.4	-	12.8	840	
	SSM6J502NU	\$ -20	-/+8	-6	-	60.5	38.4	28.3	-	23.1	-	24.8	1800	
	SSM6J501NU	\$ -20	-/+8	-10	-	43	26.5	19	-	15.3	-	29.9	2600	
	SSM6J507NU	\$ -30	25/+20	-10	-	-	-	-	32	28	20	13.6	1150	
DFN2020B (WF)	XSM6J372NW ☆ # \$	\$ -30	-12/+6	-6	-	-	144	72	-	50	42	8.2	560	
	XSM6J374NW ★ # \$	\$ -30	20/+10	-4	-	-	-	-	136	105	71	5.9	280	
	XSM6J356NW ★ # \$	\$ -60	20/+10	-2	-	-	-	-	400	360	300	8.3	330	
	XSM6J351NW ★ # \$	\$ -60	20/+10	-4	-	-	-	-	184	164	134	15.1	660	
SOT-23F	SSM3J338R	\$ -12	-/+10	-6	-	-	45.3	27.9	21.9 (@-3.6 V)	20.2	17.6 (@-8 V)	19.5	1400	
	SSM3J327R	\$ -20	-/+8	-3.9	-	240	168	123	-	93	-	4.6	290	
	SSM3J377R # \$	\$ -20	-8/+6	-3.9	-	240	168	123	-	93	-	4.6	290	
	SSM3J331R	\$ -20	-/+8	-4	-	150	100	75	-	55	-	10.4	630	
	SSM3J371R # \$	\$ -20	-8/+6	-4	-	150	100	75	-	55	-	10.4	630	
	SSM3J328R	\$ -20	-/+8	-6	-	88.4	56	39.7	-	29.8	-	12.8	840	
	SSM3J378R # \$	\$ -20	-8/+6	-6	-	88.4	56	39.7	-	29.8	-	12.8	840	
	SSM3J355R	\$ -20	-/+10	-6	-	-	52.3	38.8	-	30.1	-	16.6	1030	
	SSM3J358R	\$ -20	-/+10	-6	-	-	49.3	32.8	27.7 (@-3.6 V)	25.3	22.1 (@-8 V)	38.5	1331	
	SSM3J334R	\$ -30	-/+20	-4	-	-	-	-	136	105	71	5.9	280	
	SSM3J374R # \$	\$ -30	20/+10	-4	-	-	-	-	136	105	71	5.9	280	
	SSM3J340R	\$ -30	25/+20	-4	-	-	-	-	86	73	45	6.2	492	
	SSM3J332R	\$ -30	-/+12	-6	-	-	144	72	-	50	42	8.2	560	
	SSM3J372R # \$	\$ -30	-12/+6	-6	-	-	144	72	-	50	42	8.2	560	
	SSM3J356R # \$	\$ -60	20/+10	-2	-	-	-	-	400	360	300	8.3	330	
	SSM3J351R # \$	\$ -60	20/+10	-3.5	-	-	-	-	184	164	134	15.1	660	
S-Mini	SSM3J325F	\$ -20	-/+8	-2	-	311	231	179	-	150	-	4.6	270	
	SSM3J375F # \$	\$ -20	-8/+6	-2	-	311	231	179	-	150	-	4.6	270	
	SSM3J352F	\$ -20	-/+12	-2	-	-	443	199	-	136	110	5.1	210	
	SSM3J353F	\$ -30	25/+20	-2	-	-	-	-	274	232	150	3.4	159	

☆ New Products

# AEC-Q101 qualified, \$ With protection Zener diode between gate and source

★ Under Development (The specification is subject to change without notice.)









## P-Channel Single MOSFETs

Package	Part Number	V <sub>DSS</sub> (V)	V <sub>GSS</sub> (V)	I <sub>D</sub> (A)	R <sub>DS(ON)</sub> max (mΩ)							Q <sub>g</sub> typ. (nC)	C <sub>iss</sub> typ. (pF)	Note
					V <sub>GS</sub> = 1.2 V	V <sub>GS</sub> = 1.5 V	V <sub>GS</sub> = 1.8 V	V <sub>GS</sub> = 2.5 V	V <sub>GS</sub> = 4 V	V <sub>GS</sub> = 4.5 V	V <sub>GS</sub> = 10 V			
TSOP6F	SSM6J801R \$	-20	-8/+6	-6	-	88.4	56	39.7	-	32.5	-	12.8	840	
	XSM6J828R ★ # \$	-20	-8/+8	-4	-	-	168	123	-	93	-	4.6	290	
	SSM6J825R \$	-30	-20/+10	-4	-	-	-	-	86	73	45	6.2	492	
	XSM6J830R ☆ # \$	-30	-20/+10	-4	-	-	-	-	136	105	71	5.9	280	
	SSM6J808R	-40	-20/+10	-7	-	-	-	-	52	48	35	24.2	1020	
	XSM6J832R ★ # \$	-60	-20/+10	-2	-	-	-	-	400	360	300	8.3	330	
	XSM6J831R ★ # \$	-60	-20/+10	-4	-	-	-	-	184	164	134	15.1	660	

☆ New Products

# AEC-Q101 qualified, \$ With protection Zener diode between gate and source

★ Under Development (The specification is subject to change without notice.)



CST3 (SOT-883)	VESM (SOT-723)	SSM (SOT-416)	UFM (SOT-323F)	ES6 (SOT-563)	UF6 (SOT-363F)	WCSP6C
Bottom View 						Bottom View 
1.0 x 0.6	1.2 x 1.2	1.6 x 1.6	2.0 x 2.1	1.6 x 1.6	2.0 x 2.1	1.5 x 1.0

## N-Channel Single MOSFETs

Package	Part Number	V <sub>DSS</sub> (V)	V <sub>GSS</sub> (V)	I <sub>D</sub> (A)	R <sub>DS(ON)</sub> max (mΩ)							Q <sub>g</sub> typ. (nC)	C <sub>iss</sub> typ. (pF)	Note
					V <sub>GS</sub> = 1.2 V	V <sub>GS</sub> = 1.5 V	V <sub>GS</sub> = 1.8 V	V <sub>GS</sub> = 2.5 V	V <sub>GS</sub> = 4 V	V <sub>GS</sub> = 4.5 V	V <sub>GS</sub> = 10 V			
CST3	SSM3K56CT	\$ 20	+/-8	0.8	-	840	480	300	-	235	-	1	55	
	SSM3K56ACT	\$ 20	+/-8	1.4	-	840	480	300	-	235	-	1	55	
	SSM3K76CT ☆	\$ 20	+/-8	1.4	-	840	480	300	-	235	-	1	55	Low leakage current
VESM	SSM3K36MFV	\$ 20	+/-10	0.5	-	1520	1140	850	-	660	630 (@5 V)	1.23	46	
	SSM3K56MFV	\$ 20	+/-8	0.8	-	840	480	300	-	235	-	1	55	
	SSM3K76MFV ☆	\$ 20	+/-8	0.8	-	840	480	300	-	235	-	1	55	Low leakage current
WCSP6C	SSM6K781G	12	+/-8	7	-	124	47.4	23.2	-	18	-	5.4	600	
SSM	SSM3K36FS	\$ 20	+/-10	0.5	-	1520	1140	850	-	660	630 (@5 V)	1.23	46	
	SSM3K56FS	\$ 20	+/-8	0.8	-	840	480	300	-	235	-	1	55	
	SSM3K76FS ☆	\$ 20	+/-8	0.8	-	840	480	300	-	235	-	1	55	Low leakage current
ES6	SSM6K217FE	\$ 40	+/-12	1.8	-	-	400	248	218 (@3.6 V) 211 (@4.2 V)	208	195 (@8 V)	1.1	130	
UFM	SSM3K36TU	\$ 20	+/-10	0.5	-	1520	1140	850	-	660	630 (@5 V)	1.23	46	
	SSM3K62TU #	\$ 20	+/-8	0.8	432	139	89	68	-	57	-	2	177	
	SSM3K121TU	\$ 20	+/-10	3.2	-	140	93	63	48	-	-	5.9	400	
	SSM3K123TU	\$ 20	+/-10	4.2	-	66	43	32	28	-	-	13.6	1010	
	SSM3K127TU	\$ 30	+/-12	2	-	-	286	167	123	-	-	1.5	123	
	SSM3K116TU	\$ 30	+/-12	2.2	-	-	-	135	-	100	-	-	245	
	SSM3K2615TU	\$ 60	+/-20	2	-	-	-	580 (@3.3 V)	440	-	300	6	150	
	SSM3K341TU #	\$ 60	+/-20	6	-	-	-	-	69	51	36	9.3	550	T <sub>ch</sub> = 175 °C
SSM3K361TU #	\$ 100	+/-20	3.5	-	-	-	-	-	92	69	3.2	430	T <sub>ch</sub> = 175 °C	
UF6	SSM6K404TU	\$ 20	+/-10	3	-	147	100	70	55	-	-	5.9	400	
	SSM6K407TU	\$ 60	+/-20	2	-	-	-	-	440	-	300	6	150	

☆ New Products

# AEC-Q101 qualified, \$ With protection Zener diode between gate and source

UDFN6B (SOT-1220)	DFN2020B(WF)
Bottom View  2.0 x 2.0	Bottom View  2.0 x 2.0

## N-Channel Single MOSFETs

Package	Part Number	V <sub>DSS</sub> (V)	V <sub>GSS</sub> (V)	I <sub>D</sub> (A)	R <sub>DS(ON)</sub> max (mΩ)						Q <sub>g</sub> typ. (nC)	C <sub>iss</sub> typ. (pF)	Note	
					V <sub>GS</sub> = 1.2 V	V <sub>GS</sub> = 1.5 V	V <sub>GS</sub> = 1.8 V	V <sub>GS</sub> = 2.5 V	V <sub>GS</sub> = 4 V	V <sub>GS</sub> = 4.5 V				V <sub>GS</sub> = 10 V
UDFN6B	SSM6K518NU	\$ 20	+/-8	6	-	108	74	45	-	33	-	3.6	410	
	SSM6K517NU	\$ 30	+12/-8	6	-	-	82	53	-	39.1	-	3.2	310	
	SSM6K504NU	\$ 30	+/-20	9	-	-	-	-	-	26	19.5	4.8	620	
	SSM6K513NU	\$ 30	+/-20	15	-	-	-	-	-	12	8.9	7.5	1130	
	SSM6K516NU	\$ 30	+20/-12	6	-	-	-	-	-	64	46	2.5	280	
	SSM6K514NU	\$ 40	+/-20	12	-	-	-	-	-	17.3	11.6	7.5	1110	
	SSM6K388NU ☆	\$ 60	+/-20	2	-	-	-	-	-	99	87	2.66	315	
	SSM6K389NU ☆	\$ 60	+/-20	2	-	-	-	-	-	200	171	1.84	158	
	SSM6K341NU	\$ 60	+/-20	6	-	-	-	-	69	51	36	9.3	550	
DFN2020B (WF)	SSM6K387NU ☆	\$ 100	+/-20	2	-	-	-	-	-	198	125	3.6	242	
	SSM6K361NU	\$ 100	+/-20	3.5	-	-	-	-	-	92	69	3.2	430	
	XSM6K376NW ☆ #	\$ 30	+12/-8	4	-	-	109	72	-	56	-	2.2	200	
	XSM6K336NW ☆ #	\$ 30	+/-20	3	-	-	-	-	-	140	95	1.7	126	
	XSM6K519NW ☆ #	\$ 40	+/-20	8	-	-	-	-	-	36.3	17.8	6.5	797	Tch = 175°C
	XSM6K341NW ★ #	\$ 60	+/-20	6	-	-	-	-	69	51	36	9.3	550	Tch = 175°C
	XSM6K383NW ★ #	\$ 80	+/-20	3.6	-	-	-	-	-	-	71	3.6	321	Tch = 175°C
	XSM6K382NW ★ #	\$ 80	+/-20	3	-	-	-	-	-	-	102.9	3	211	Tch = 175°C
XSM6K381NW ★ #	\$ 80	+/-20	5.1	-	-	-	-	-	-	36.7	5.1	584	Tch = 175°C	
XSM6K361NW ☆ #	\$ 100	+/-20	3.5	-	-	-	-	-	92	69	3.2	430		

☆ New Products

★ Under Development (The specification is subject to change without notice.)

# AEC-Q101 qualified, \$ With protection Zener diode between gate and source







## N-Channel Single MOSFETs

Package	Part Number	V <sub>BSS</sub> (V)	V <sub>GSS</sub> (V)	I <sub>D</sub> (A)	R <sub>DS(ON)</sub> max (mΩ)						Q <sub>g</sub> typ. (nC)	C <sub>iss</sub> typ. (pF)	Note		
					V <sub>GS</sub> = 1.2 V	V <sub>GS</sub> = 1.5 V	V <sub>GS</sub> = 1.8 V	V <sub>GS</sub> = 2.5 V	V <sub>GS</sub> = 4 V	V <sub>GS</sub> = 4.5 V				V <sub>GS</sub> = 10 V	
SOT-23F	SSM3K344R	\$ 20	+/-8	3	-	232	139	91	-	71	-	2	153		
	SSM3K345R	\$ 20	+/-8	4	-	108	74	45	-	33	-	3.6	410		
	SSM3K324R	\$ 30	+/-12	4	-	-	109	72	-	56	-	2.2	200		
	SSM3K376R	# \$ 30	+12/-8	4	-	-	109	72	-	56	-	2.2	200		
	SSM3K336R	\$ 30	+/-20	3	-	-	-	-	-	140	95	1.7	126		
	SSM3K333R	\$ 30	+/-20	6	-	-	-	-	-	42	28	3.4	436		
	SSM3K335R	\$ 30	+/-20	6	-	-	-	-	-	56	38	2.7	340		
	SSM3K347R	\$ 38	+/-20	2	-	-	-	-	-	480	410	340	2.5	86	Built-in Active Clamp Zener
	SSM3K337R	\$ 38	+/-20	2	-	-	-	-	-	200	176	150	3	120	Built-in Active Clamp Zener
	SSM3K339R	\$ 40	+/-12	2	-	-	390	238	208 (@3.6 V) 201 (@4.2 V)	198	185 (@8 V)	1.1	130	Built-in Gate-Drain Zener	
	SSM3K357R	\$ 60	+/-12	0.65	-	-	-	2400 (@3 V)	-	1800 (@5 V)	-	1.5	43		
	SSM3K2615R	\$ 60	+/-20	2	-	-	-	580 (@3.3 V)	440	-	300	6	150		
	SSM3K388R	☆ \$ 60	+/-20	2	-	-	-	-	-	99	87	2.66	315		
	SSM3K389R	☆ \$ 60	+/-20	2	-	-	-	-	-	200	171	1.84	158		
	SSM3K318R	\$ 60	+/-20	2.5	-	-	-	-	-	145	107	7	235		
SSM3K341R	# \$ 60	+/-20	6	-	-	-	-	-	69	51	36	9.3	550	T <sub>ch</sub> = 175°C	
SSM3K387R	☆ \$ 100	+/-20	2	-	-	-	-	-	198	125	3.6	242			
SSM3K361R	# \$ 100	+/-20	3.5	-	-	-	-	-	92	69	3.2	430	T <sub>ch</sub> = 175°C		
TSOP6F	SSM6K824R	\$ 20	+/-8	6	-	108	74	45	-	33	-	3.6	410		
	SSM6K818R	\$ 30	+/-20	15	-	-	-	-	-	12	8.9	7.5	1130		
	SSM6K804R	\$ 40	+/-20	12	-	-	-	-	-	18	12	7.5	1110		
	XSM6K837R	★ # \$ 40	+/-20	8	-	-	-	-	-	37	16	6.5	797	T <sub>ch</sub> = 175°C	
	SSM6K388R	☆ \$ 60	+/-20	2	-	-	-	-	-	99	87	2.66	315		
	SSM6K389R	☆ \$ 60	+/-20	2	-	-	-	-	-	200	171	1.84	158		
	SSM6K809R	\$ 60	+/-20	6	-	-	-	-	-	69	51	36	9.3	550	T <sub>ch</sub> = 175°C
	XSM6K836R	★ # \$ 60	+/-20	6.7	-	-	-	-	-	38	29	21	24	1328	T <sub>ch</sub> = 175°C
	SSM6K387R	☆ \$ 100	+/-20	2	-	-	-	-	-	198	125	3.6	242		
	SSM6K810R	\$ 100	+/-20	3.5	-	-	-	-	-	92	69	3.2	430	T <sub>ch</sub> = 175°C	
SSM6K819R	\$ 100	+/-20	10	-	-	-	-	-	36.4	25.8	8.5	1110	T <sub>ch</sub> = 175°C		

☆ New Products

★ Under Development (The specification is subject to change without notice.)





# AEC-Q101 qualified, \$ With protection Zener diode between gate and source

ES6 (SOT-563)	UF6 (SOT-363F)	UDFN6 (SOT-1118)	DFN2020(WF)
		Bottom View 	Bottom View 
1.6 x 1.6	2.0 x 2.1	2.0 x 2.0	2.0 x 2.0

## Dual MOSFETs

Package	Polarity	Part Number	V <sub>DS</sub> (V)	V <sub>GSS</sub> (V)	I <sub>D</sub> (A)	R <sub>DS(on)</sub> max (mΩ)						Q <sub>g</sub> typ. (nC)	C <sub>iss</sub> typ. (pF)	Note	
						V <sub>Gs</sub>   = 1.2 V	V <sub>Gs</sub>   = 1.5 V	V <sub>Gs</sub>   = 1.8 V	V <sub>Gs</sub>   = 2.5 V	V <sub>Gs</sub>   = 4 V	V <sub>Gs</sub>   = 4.5 V				V <sub>Gs</sub>   = 10 V
ES6	P-ch x2	SSM6P41FE	\$ -20	-/+8	-0.72	-	1040	670	440	-	300	-	1.76	110	
		SSM6P56FE	\$ -20	-/+8	-0.8	4000	900	660	480	-	390	-	1.6	100	
		SSM6P76FE ☆	\$ -20	-/+8	-0.8	4000	900	660	480	-	390	-	1.6	100	Low leakage current
	N-ch x2	SSM6N36FE	\$ 20	+/-10	0.5	-	1520	1140	850	-	660	630 (@5V)	1.23	46	
		SSM6N56FE	\$ 20	+/-8	0.8	-	840	480	300	-	235	-	1	55	
		SSM6N76FE ☆	\$ 20	+/-8	0.8	-	840	480	300	-	235	-	1	55	Low leakage current
N-ch + P-ch	SSM6L56FE	\$ 20	+/-8	0.8	-	840	480	300	-	235	-	1	55		
UDFN6	P-ch x2	SSM6P47NU	\$ -20	-/+8	-4	-	242	170	125	-	95	-	4.6	290	
		SSM6P69NU	\$ -20	-12/+6	-4	-	-	157	76	-	56	45	6.74	480	
		SSM6P49NU	\$ -20	-/+12	-4	-	-	157	76	-	56	45	6.74	480	
	N-ch x2	SSM6N61NU	\$ 20	+/-8	4	-	108	74	45	-	33	-	3.6	410	
		SSM6N55NU	\$ 30	+/-20	4	-	-	-	-	-	64	46	2.5	280	
		SSM6N67NU	\$ 30	+12/-8	4	-	-	82	53	-	39.1	-	3.2	310	
		SSM6N68NU	\$ 30	+12/-8	4	-	-	180	117	-	84	-	1.8	129	
		SSM6N57NU	\$ 30	+/-12	4	-	-	82	53	-	39.1	-	3.2	310	
		SSM6N58NU	\$ 30	+/-12	4	-	-	180	117	-	84	-	1.8	129	
N-ch + P-ch	SSM6L61NU	\$ 20	+/-8	4	-	108	74	45	-	33	-	3.6	410		
DFN2020 (WF)	N-ch x2	XSM6N65NW ★ # \$	\$ 30	+20/-12	4	-	-	-	-	64	46	2.5	280	Automotive equipment	
		XSM6N67NW ★ # \$	\$ 30	+12/-8	4	-	-	82	53	-	39.1	-	3.2	310	
UF6	N-ch x2	SSM6N36TU	\$ 20	+/-10	0.5	-	1520	1140	850	-	660	630 (@5V)	1.23	46	
		SSM6N62TU #	\$ 20	+/-8	0.8	456	173	120	98	-	85	-	2	177	
		SSM6N39TU	\$ 20	+/-10	1.6	-	247	190	139	119	-	-	7.5	260	
		SSM6N24TU	\$ 30	+/-12	0.5	-	-	-	180	-	145	-	-	245	

☆ New Products, ★ Under Development (The specification is subject to change without notice.)  
# AEC-Q101 qualified, \$ With protection Zener diode between gate and source

TSOP6F	TCSPA-172101	TCSPAC-153001	TCSPED-302701	TCSPAG-341501
	Bottom View 	Bottom View 	Bottom View 	Bottom View 
2.9 x 2.8	2.14 x 1.67	2.98 x 1.49	3.0 x 2.74	3.37 x 1.47

## Dual MOSFETs





Package	Polarity	Part Number	V <sub>DSS</sub> or V <sub>SSS</sub> (V)	V <sub>GSS</sub> (V)	I <sub>D</sub> or I <sub>S</sub> (A)	R <sub>DS(ON)</sub> max or R <sub>SS(ON)</sub> max (mΩ)							Q <sub>g</sub> typ. (nC)	C <sub>iss</sub> typ. (pF)	Note
						V <sub>GS</sub>   = 1.2 V	V <sub>GS</sub>   = 1.5 V	V <sub>GS</sub>   = 1.8 V	V <sub>GS</sub>   = 2.5 V	V <sub>GS</sub>   = 4 V	V <sub>GS</sub>   = 4.5 V	V <sub>GS</sub>   = 10 V			
TSOP6F	N-ch x 2	SSM6N357R	\$ 60	+/-12	0.65	-	-	-	2400 (@3 V)	-	1800 (@5 V)	-	1.5	43	Built-in Gate-Drain Zener
		SSM6N815R	\$ 100	+/-20	2	-	-	-	-	180	142	103	3.1	290	
		SSM6N813R	\$ 100	+/-20	3.5	-	-	-	-	-	154	112	3.6	242	T <sub>ch</sub> = 175 °C
	P-ch x 2	SSM6P816R	\$ -20	-/+10	-6	-	-	52.3	38.8	-	30.1	-	16.6	1030	
		N-ch + P-ch	SSM6L807R	\$ 30	+/-12	4	-	-	82	53	-	39.1	-	3.2	310
	\$ -20			-/+12	-4	-	-	157	76	-	56	45	6.74	480	
	SSM6L820R		\$ 30	+12/-8	4	-	-	82	53	-	39.1	-	3.2	310	
			\$ -20	-12/+6	-4	-	-	157	76	-	56	45	6.7	480	
SSM6L826R ☆	\$ 30	+20/-12	4	-	-	-	-	-	64	46	2.5	280			
\$ -30	-20/+10	-4	-	-	-	-	-	73	45	6.2	492				
TCSPA-172101	N-ch x 2	SSM6N951L	\$ 12	+/-8	8	-	-	-	10	5.5 (@3.8 V)	5.1	-	26	-	Drain common
TCSPAC-153001	N-ch x 2	SSM10N954L	\$ 12	+/-8	13.5	-	-	-	6.1	2.85 (@3.8 V)	2.75	-	25	-	Drain common
TCSPED-302701	N-ch x 2	SSM14N956L	\$ 12	+/-8	20	-	-	-	3.2	1.5 (@3.8 V)	1.35	-	76	-	Drain common
TCSPAG-341501	N-ch x 2	SSM10N961L ☆	\$ 30	+/-20	14	-	-	-	-	-	17.6	12.8	8.8	-	Drain common

☆ New Products

§ With protection Zener diode between gate and source

## 2. Less than 500mA Series MOSFETs (Standard Type)

Package Dimensions (unit: mm)

CST3C	CST3 (SOT-883)	VESM (SOT-723)	SSM (SOT-416)	UFM (SOT-323F)	USM (SOT-323)	S-Mini (SOT-346)
Bottom View	Bottom View					
0.8 x 0.6	1.0 x 0.6	1.2 x 1.2	1.6 x 1.6	2.0 x 2.1	2.0 x 2.1	2.9 x 2.5







### P-Channel Single MOSFETs

Package	Part Number	V <sub>DSS</sub> (V)	V <sub>GSS</sub> (V)	I <sub>D</sub> (A)	R <sub>DS(ON)</sub> max (Ω)							Note
					V <sub>GS</sub> = -1.2 V	V <sub>GS</sub> = -1.5 V	V <sub>GS</sub> = -1.8 V	V <sub>GS</sub> = -2.5 V	V <sub>GS</sub> = -4 V	V <sub>GS</sub> = -4.5 V	V <sub>GS</sub> = -10 V	
CST3C	SSM3J35CTC	\$ -20	-/+10	-0.25	20	4	2.9	2.1	-	1.4	-	
	SSM3J78CTC ☆	\$ -20	-/+10	-0.25	20	4	2.9	2.1	-	1.4	-	Low leakage current
CST3	SSM3J16CT ●	\$ -20	-/+10	-0.1	-	45	-	12	8	-	-	⇒ SSM3J78CTC
	SSM3J15CT	\$ -30	-/+20	-0.1	-	-	-	32	12	-	-	
VESM	SSM3J36MFV	\$ -20	-/+8	-0.33	-	3.6	2.7	1.6 (@-2.8 V)	-	1.31	-	⇒ SSM3J56MFV
	SSM3J35AMFV	\$ -20	-/+10	-0.25	20	4	2.9	2.1	-	1.4	-	
	SSM3J78MFV ☆	\$ -20	-/+10	-0.25	20	4	2.9	2.1	-	1.4	-	Low leakage current
	SSM3J15FV	\$ -30	-/+20	-0.1	-	-	-	32	12	-	-	
SSM	SSM3J35AFS	\$ -20	-/+10	-0.25	20	4	2.9	2.1	-	1.4	-	
	SSM3J78FS ☆	\$ -20	-/+10	-0.25	20	4	2.9	2.1	-	1.4	-	Low leakage current
	SSM3J36FS	\$ -20	-/+8	-0.33	-	3.6	2.7	1.6 (@-2.8 V)	-	1.31	-	
	SSM3J15FS	\$ -30	-/+20	-0.1	-	-	-	32	12	-	-	
UFM	SSM3J36TU	\$ -20	-/+8	-0.33	-	3.6	2.7	1.6 (@-2.8 V)	-	1.31	-	
USM	SSM3J15FU	\$ -30	-/+20	-0.1	-	-	-	32	12	-	-	
S-Mini	SSM3J15F	\$ -30	-/+20	-0.1	-	-	-	32	12	-	-	
	SSM3J168F #	\$ -60	-20/+10	-0.4	-	-	-	-	2	1.9	1.55	

☆ New Products

● Recommended Another New Product





# AEC-Q101 qualified, \$ With protection Zener diode between gate and source

CST3C	CST3 (SOT-883)	VESM (SOT-723)	SSM (SOT-416)	USM (SOT-323)	SOT23 (SOT-23)	S-Mini (SOT-346)
Bottom View 	Bottom View 					
0.8 x 0.6	1.0 x 0.6	1.2 x 1.2	1.6 x 1.6	2.0 x 2.1	2.9 x 2.4	2.9 x 2.5

## N-Channel Single MOSFETs

Package	Part Number	V <sub>DSS</sub> (V)	V <sub>GSS</sub> (V)	I <sub>D</sub> (A)	R <sub>DS(ON)</sub> max (Ω)								Note
					V <sub>GS</sub> = 1.2 V	V <sub>GS</sub> = 1.5 V	V <sub>GS</sub> = 1.8 V	V <sub>GS</sub> = 2.5 V	V <sub>GS</sub> = 4 V	V <sub>GS</sub> = 4.5 V	V <sub>GS</sub> = 5 V	V <sub>GS</sub> = 10 V	
CST3C	SSM3K35CTC	\$ 20	+/-10	0.25	9	3.1	2.4	1.6	-	1.1	-	-	
	SSM3K78CTC ☆	\$ 20	+/-10	0.25	9	3.1	2.4	1.6	-	1.1	-	-	Low leakage current
	SSM3K15ACTC	\$ 30	+/-20	0.1	-	-	-	6	3.6	-	-	-	
	SSM3K79CTC ☆	\$ 30	+/-20	0.1	-	-	-	6	3.6	-	-	-	Low leakage current
	SSM3K72CTC	\$ 60	+/-20	0.15	-	-	-	5.7 (typ.)	-	4.7	4.4	3.9	
CST3	SSM3K16CT	\$ 20	+/-10	0.1	-	15	-	4	3	-	-	-	
	SSM3K37CT	\$ 20	+/-10	0.2	-	5.6	4.05	3.02	-	2.2	-	-	
	SSM3K77CT ☆	\$ 20	+/-10	0.2	-	5.6	4.05	3.1	-	2.2	-	-	Low leakage current
	SSM3K15CT ●	\$ 30	+/-20	0.1	-	-	-	7	4	-	-	-	⇒ SSM3K15ACT
	SSM3K15ACT	\$ 30	+/-20	0.1	-	-	-	6	3.6	-	-	-	
	SSM3K79CT ☆	\$ 30	+/-20	0.1	-	-	-	6	3.6	-	-	-	Low leakage current
	SSM3K72KCT	\$ 60	+/-20	0.4	-	-	-	-	-	1.75	1.65	1.5	
VESM	SSM3K16FV	\$ 20	+/-10	0.1	-	15	-	4	3	-	-	-	
	SSM3K37MFV	\$ 20	+/-10	0.25	-	5.6	4.05	3.02	-	2.2	-	-	
	SSM3K77MFV ☆	\$ 20	+/-10	0.25	-	5.6	4.05	3.1	-	2.2	-	-	Low leakage current
	SSM3K35AMFV	\$ 20	+/-10	0.25	9	3.1	2.4	1.6	-	1.1	-	-	
	SSM3K78MFV ☆	\$ 20	+/-10	0.25	9	3.1	2.4	1.6	-	1.1	-	-	Low leakage current
	SSM3K15AMFV	\$ 30	+/-20	0.1	-	-	-	6	3.6	-	-	-	
	SSM3K79MFV ☆	\$ 30	+/-20	0.1	-	-	-	6	3.6	-	-	-	Low leakage current
	SSM3K44MFV	\$ 30	+/-20	0.1	-	-	-	7	4	-	-	-	
SSM	SSM3K16FS	\$ 20	+/-10	0.1	-	15	-	4	3	-	-	-	⇒ SSM3K37FS
	SSM3K37FS	\$ 20	+/-10	0.2	-	5.6	4.05	3.02	-	2.2	-	-	
	SSM3K77FS ☆	\$ 20	+/-10	0.2	-	5.6	4.05	3.1	-	2.2	-	-	Low leakage current
	SSM3K35AFS	\$ 20	+/-10	0.25	9	3.1	2.4	1.6	-	1.1	-	-	
	SSM3K78FS ☆	\$ 20	+/-10	0.25	9	3.1	2.4	1.6	-	1.1	-	-	Low leakage current
	SSM3K15FS ●	\$ 30	+/-20	0.1	-	-	-	7	4	-	-	-	⇒ SSM3K15AFS
	SSM3K44FS	\$ 30	+/-20	0.1	-	-	-	7	4	-	-	-	
	SSM3K15AFS	\$ 30	+/-20	0.1	-	-	-	6	3.6	-	-	-	
	SSM3K79FS ☆	\$ 30	+/-20	0.1	-	-	-	6	3.6	-	-	-	Low leakage current
		SSM3K72CFS	\$ 60	+/-20	0.17	-	-	-	-	-	4.7	4.4	3.9
	SSM3K72KFS #	\$ 60	+/-20	0.3	-	-	-	-	-	1.75	1.65	1.5	
USM	SSM3K16FU	\$ 20	+/-10	0.1	-	15	-	4	3	-	-	-	
	SSM3K15FU ●	\$ 30	+/-20	0.1	-	-	-	7	4	-	-	-	⇒ SSM3K15AFU
	SSM3K15AFU	\$ 30	+/-20	0.1	-	-	-	6	3.6	-	-	-	
	SSM3K79FU ☆	\$ 30	+/-20	0.1	-	-	-	6	3.6	-	-	-	Low leakage current
		SSM3K7002CFU	\$ 60	+/-20	0.17	-	-	-	-	-	4.7	4.4	3.9
	SSM3K7002KFU #	\$ 60	+/-20	0.4	-	-	-	-	-	1.75	1.65	1.5	
SOT23	T2N7002AK	\$ 60	+/-20	0.2	-	-	-	-	-	4.7	4.4	3.9	
	T2N7002BK	\$ 60	+/-20	0.4	-	-	-	-	-	1.75	1.65	1.5	
S-Mini	SSM3K15F	\$ 30	+/-20	0.1	-	-	-	7	4	-	-	-	
	SSM3K7002KF #	\$ 60	+/-20	0.4	-	-	-	-	-	1.75	1.65	1.5	

☆ New Products, ● Recommended Another New Product  
 # AEC-Q101 qualified, \$ With protection Zener diode between gate and source

ESV (SOT-553)	ES6 (SOT-563)	USV (SOT-353)	UF6 (SOT-363F)
			
1.6 x 1.6	1.6 x 1.6	2.0 x 2.1	2.0 x 2.1

## Dual MOSFETs

Package	Polarity	Part Number	V <sub>bss</sub> (V)	V <sub>gss</sub> (V)	I <sub>D</sub> (A)	R <sub>DS(ON)</sub> max (Ω)								Note
						V <sub>GS</sub>   = 1.2 V	V <sub>GS</sub>   = 1.5 V	V <sub>GS</sub>   = 1.8 V	V <sub>GS</sub>   = 2.5 V	V <sub>GS</sub>   = 4 V	V <sub>GS</sub>   = 4.5 V	V <sub>GS</sub>   = 5 V	V <sub>GS</sub>   = 10 V	
ESV	P-ch x2	SSM5P16FE	\$ -20	-/+10	-0.1	-	45	-	12	8	-	-	-	
	N-ch x2	SSM5N16FE	\$ 20	+/-10	0.1	-	15	-	4	3	-	-	-	
		SSM5N15FE	\$ 30	+/-20	0.1	-	-	-	7	4	-	-	-	
ES6	P-ch x2	SSM6P35AFE	\$ -20	-/+10	-0.25	20	4	2.9	2.1	-	1.4	-	-	
		SSM6P78FE ☆	\$ -20	-/+10	-0.25	20	4	2.9	2.1	-	1.4	-	-	Low leakage current
		SSM6P36FE	\$ -20	-/+8	-0.33	-	3.6	2.7	1.6 (@-2.8V)	-	1.31	-	-	
		SSM6P15FE	\$ -30	+/-20	-0.1	-	-	-	32	12	-	-	-	
	N-ch x2	SSM6N37FE	\$ 20	+/-10	0.25	-	5.6	4.05	3.02	-	2.2	-	-	
		SSM6N77FE ☆	\$ 20	+/-10	0.25	-	5.6	4.05	3.1	-	2.2	-	-	Low leakage current
		SSM6N35AFE	\$ 20	+/-10	0.25	9	3.1	2.4	1.6	-	1.1	-	-	
		SSM6N78FE ☆	\$ 20	+/-10	0.25	9	3.1	2.4	1.6	-	1.1	-	-	Low leakage current
		SSM6N44FE	\$ 30	+/-20	0.1	-	-	-	7	4	-	-	-	
		SSM6N15AFE	\$ 30	+/-20	0.1	-	-	-	6	3.6	-	-	-	
		SSM6N79FE ☆	\$ 30	+/-20	0.1	-	-	-	6	3.6	-	-	-	Low leakage current
	N-ch + P-ch	SSM6N7002BFE	\$ 60	+/-20	0.2	-	-	-	-	-	3.3	2.6	2.1	
SSM6L36FE		\$ -20	-/+8	-0.33	-	3.6	2.7	1.6 (@-2.8V)	-	1.31	-	-		
USV	P-ch x2	SSM5P15FU	\$ -30	+/-20	-0.1	-	-	-	32	12	-	-	-	
	N-ch x2	SSM5N16FU	\$ 20	+/-10	0.1	-	15	-	4	3	-	-	-	
		SSM5N15FU	\$ 30	+/-20	0.1	-	-	-	7	4	-	-	-	
UF6	P-ch x2	SSM6P36TU	\$ -20	-/+8	-0.33	-	3.6	2.7	1.6 (@-2.8V)	-	1.31	-	-	
	N-ch + P-ch	SSM6L36TU	\$ 20	+/-10	0.5	-	1.52	1.14	0.85	-	0.66	0.63	-	
			\$ -20	-/+8	-0.33	-	3.6	2.7	1.6 (@-2.8V)	-	1.31	-	-	

☆ New Products

\$ With protection Zener diode between gate and source





## Dual MOSFETs

Package	Polarity	Part Number	V <sub>DSS</sub> (V)	V <sub>GSS</sub> (V)	I <sub>D</sub> (A)	R <sub>DS(ON)</sub> max (Ω)								Note
						V <sub>Gs</sub>   = 1.2 V	V <sub>Gs</sub>   = 1.5 V	V <sub>Gs</sub>   = 1.8 V	V <sub>Gs</sub>   = 2.5 V	V <sub>Gs</sub>   = 4 V	V <sub>Gs</sub>   = 4.5 V	V <sub>Gs</sub>   = 5 V	V <sub>Gs</sub>   = 10 V	
US6	P-ch x2	SSM6P35AFU	\$ -20	-/+10	0.25	20	4	2.9	2.1	-	1.4	-	-	
		SSM6P78FU ☆	\$ -20	-/+10	0.25	20	4	2.9	2.1	-	1.4	-	-	Low leakage current
		SSM6P15FU	\$ -30	-/+20	0.1	-	-	-	32	12	-	-	-	
	N-ch x2	SSM6N16FU	\$ 20	+/-10	0.1	-	15	-	4	3	-	-	-	
		SSM6N35AFU	\$ 20	+/-10	0.25	9	3.1	2.4	1.6	-	1.1	-	-	
		SSM6N78FU ☆	\$ 20	+/-10	0.25	9	3.1	2.4	1.6	-	1.1	-	-	Low leakage current
		SSM6N37FU	\$ 20	+/-10	0.25	-	5.6	4.05	3.02	-	2.2	-	-	
		SSM6N77FU ☆	\$ 20	+/-10	0.25	-	5.6	4.05	3.1	-	2.2	-	-	Low leakage current
		SSM6N44FU	\$ 30	+/-20	0.1	-	-	-	7	4	-	-	-	
		SSM6N15FU ●	\$ 30	+/-20	0.1	-	-	-	7	4	-	-	-	⇒ SSM6N15AFU
		SSM6N15AFU	\$ 30	+/-20	0.1	-	-	-	6	3.6	-	-	-	
		SSM6N79FU ☆	\$ 30	+/-20	0.1	-	-	-	6	3.6	-	-	-	Low leakage current
SSM6N702CFU	\$ 60	+/-20	0.17	-	-	-	-	-	-	4.7	4.4	3.9		
SSM6N702KFU	# \$ 60	+/-20	0.3	-	-	-	-	-	-	1.75	1.65	1.5		

☆ New Products, ● Recommended Another New Product, # AEC-Q101 qualified, \$ With protection Zener diode between gate and source

### 3. MOSFETs with Diode

Package Dimensions (unit: mm)

ESV (SOT-553)	UFV (SOT-353F)	UDFN6 (SOT-1118)
		
1.6 x 1.6	2.0 x 2.1	2.0 x 2.0







Bottom View

Package	Polarity	Part Number	V <sub>DSS</sub> (V)	V <sub>GSS</sub> (V)	I <sub>D</sub> (A)	MOSFET							Diode				Note	
						R <sub>DS(ON)</sub> max (mΩ)							C <sub>ISS</sub> typ. (pF)	V <sub>R</sub> (V)	I <sub>O</sub> (A)	V <sub>F</sub> max (V)		
						V <sub>GS</sub>   = 1.5 V	V <sub>GS</sub>   = 1.8 V	V <sub>GS</sub>   = 2.5 V	V <sub>GS</sub>   = 4 V	V <sub>GS</sub>   = 4.5 V	V <sub>GS</sub>   = 5 V	V <sub>GS</sub>   = 10 V				@I <sub>F</sub> (A)		
ESV	P-ch + SBD	SSM5G06FE	§ -20	¥/+10	-0.1	45000	-	12000	8000	-	-	-	11	12	0.1	0.5	0.1	
	N-ch + SBD	SSM5H06FE	§ 20	¥/-10	0.1	15000	-	4000	3000	-	-	-	9.3	12	0.1	0.5	0.1	
UFV	N-ch + SBD	SSM5H16TU	§ 30	¥/-12	1.9	-	296	177	133	-	-	-	123	30	0.8	0.55	0.8	
UDFN6	P-ch + SBD	SSM6G18NU	§ -20	¥/+8	-2	261	185	143	-	112	-	-	270	30	1	0.58	1	
	N-ch + SBD	SSM6H19NU	§ 40	¥/-12	2	-	390	238	208 (@3.6V) 201 (@4.2V)	198	-	185 (@8V)	130	40	0.5	0.57	0.5	

§ With protection Zener diode between gate and source, ¥ V<sub>RRM</sub>, ¥¥ I<sub>F(AV)</sub>

## 4. Small Signal MOSFETs for Automotive

Package Dimensions (unit: mm)

VESM (SOT-723)	UFM (SOT-323F)	UF6 (SOT-363F)	DFN2020B (WF)	S-Mini (SOT-346)	SOT-23F	TSOP6F
			Bottom View 			
1.2 x 1.2	2.0 x 2.1	2.0 x 2.1	2.0 x 2.0	2.9 x 2.5	2.9 x 2.4	2.9 x 2.8

### P-Channel Single MOSFETs

Package	Part Number	V <sub>DS</sub> (V)	V <sub>GS</sub> (V)	I <sub>D</sub> (A)	R <sub>DS(ON)</sub> max (mΩ)								Q <sub>g</sub> typ. (nC)	C <sub>iss</sub> typ. (pF)	Note
					V <sub>GS</sub> = -1.2V	V <sub>GS</sub> = -1.5V	V <sub>GS</sub> = -1.8V	V <sub>GS</sub> = -2.5V	V <sub>GS</sub> = -4V	V <sub>GS</sub> = -4.5V	V <sub>GS</sub> = -6V	V <sub>GS</sub> = -10V			
VESM	SSM3J66MFV # \$	-20	-8/+6	-0.8	4000	900	660	480	-	390	-	-	1.6	100	
DFN2020B (WF)	XSM6J372NW ☆ # \$	-30	-12/+6	-6.0	-	-	144	72	-	50	-	42	8.2	560	
	XSM6J374NW ★ # \$	-30	-20/+10	-4.0	-	-	-	-	136	105	-	71	5.9	280	
	XSM6J356NW ★ # \$	-60	-20/+10	-2.0	-	-	-	-	400	360	-	300	8.3	330	
	XSM6J351NW ★ # \$	-60	-20/+10	-3.5	-	-	-	-	184	164	-	134	15.1	660	
UFM	SSM3J145TU # \$	-20	-8/+6	-3.0	-	260	180	132	-	103	-	-	4.6	270	
	SSM3J144TU # \$	-20	-8/+6	-3.2	-	240	168	123	-	93	-	-	4.7	290	
	SSM3J140TU # \$	-20	-8/+6	-4.4	-	63.2	41.1	31	-	25.8	-	-	24.8	1800	
	SSM3J143TU # \$	-20	-8/+6	-5.5	-	88.4	56	39.7	-	29.8	-	-	12.8	840	
UF6	SSM6J422TU # \$	-20	-8/+6	-4.0	-	99.6	67.8	51.4	-	42.7	-	-	12.8	840	
SOT-23F	SSM3J377R # \$	-20	-8/+6	-3.9	-	240	168	123	-	93	-	-	4.6	290	
	SSM3J371R # \$	-20	-8/+6	-4.0	-	150	100	75	-	55	-	-	10.4	630	
	SSM3J378R # \$	-20	-8/+6	-6.0	-	88.4	56	39.7	-	29.8	-	-	12.8	840	
	SSM3J374R # \$	-30	-20/+10	-4.0	-	-	-	-	136	105	-	71	5.9	280	
	SSM3J372R # \$	-30	-12/+6	-6.0	-	-	144	72	-	50	-	42	8.2	560	
	SSM3J356R # \$	-60	-20/+10	-2.0	-	-	-	-	400	360	-	300	8.3	330	
	SSM3J351R # \$	-60	-20/+10	-3.5	-	-	-	-	184	164	-	134	15.1	660	
S-MINI	SSM3J375F # \$	-20	-8/+6	-2.0	-	311	231	179	-	150	-	-	4.6	270	
	SSM3J168F # \$	-60	-20/+10	-0.4	-	-	-	-	2000	1900	-	1550	3	82	
TSOP6F	XSM6J828R ★ # \$	-20	-8/+8	-3.9	-	-	168	123	-	93	-	-	4.6	290	
	XSM6J830R ★ # \$	-30	-20/+10	-4.0	-	-	-	-	136	105	-	71	5.9	280	
	XSM6J808R ★ # \$	-40	-20/+10	-7.0	-	-	-	-	52	48	-	35	24.2	1020	
	XSM6J832R ★ # \$	-60	-20/+10	-2.0	-	-	-	-	400	360	-	300	8.3	330	
	XSM6J831R ★ # \$	-60	-20/+10	-3.5	-	-	-	-	184	164	-	134	15.1	660	

☆ New Products

★ Under Development (The specification is subject to change without notice.)

# AEC-Q101 qualified, \$ With protection Zener diode between gate and source

## N-Channel Single MOSFETs

Package	Part Number	V <sub>DSS</sub> (V)	V <sub>GS</sub> (V)	I <sub>D</sub> (A)	R <sub>DS(ON)</sub> max (mΩ)								Q <sub>g</sub> typ. (nC)	C <sub>iss</sub> typ. (pF)	Note
					V <sub>GS</sub> =1.2V	V <sub>GS</sub> =1.5V	V <sub>GS</sub> =1.8V	V <sub>GS</sub> =2.5V	V <sub>GS</sub> =4V	V <sub>GS</sub> =4.5V	V <sub>GS</sub> =6V	V <sub>GS</sub> =10V			
SSM	SSM3K72KFS # \$	60	+/-20	0.3	-	-	-	-	-	1750	-	1500	0.39	26	
DFN2020B (WF)	XSM6K376NW ☆ # \$	30	+12/-8	6.0	-	-	109	72	-	56	-	-	2.2	200	
	XSM6K336NW ☆ # \$	30	+/-20	3.0	-	-	-	-	-	140	-	95	1.7	126	
	XSM6K519NW ☆ # \$	40	+/-20	8.0	-	-	-	-	-	36.3	-	15.3	6.5	797	T <sub>ch</sub> = 175 °C
	XSM6K341NW ★ # \$	60	+/-20	6.0	-	-	-	-	69	51	-	36	9.3	550	T <sub>ch</sub> = 175 °C
	XSM6K383NW ★ # \$	80	+/-20	3.6	-	-	-	-	-	-	94	71	3.6	321	T <sub>ch</sub> = 175 °C
	XSM6K382NW ★ # \$	80	+/-20	3.0	-	-	-	-	-	-	156	102.9	3	211	T <sub>ch</sub> = 175 °C
	XSM6K381NW ★ # \$	80	+/-20	5.1	-	-	-	-	-	-	52	36.7	5.1	584	T <sub>ch</sub> = 175 °C
	XSM6K361NW ☆ # \$	100	+/-20	3.5	-	-	-	-	-	92	-	69	3.2	430	
USM	SSM3K7002KFU # \$	60	+/-20	0.4	-	-	-	-	-	1750	-	1500	0.39	26	
UFM	SSM3K62TU # \$	20	+/-8	0.8	432	139	89	68	-	57	-	-	2	177	
	SSM3K341TU # \$	60	+/-20	6.0	-	-	-	-	69	51	-	36	9.3	550	T <sub>ch</sub> = 175 °C
	SSM3K361TU # \$	100	+/-20	3.5	-	-	-	-	-	92	-	69	3.2	430	T <sub>ch</sub> = 175 °C
SOT-23F	SSM3K376R # \$	30	+12/-8	4.0	-	-	109	72	-	56	-	-	2.2	200	
	SSM3K341R # \$	60	+/-20	6.0	-	-	-	-	69	51	-	36	9.3	550	T <sub>ch</sub> = 175 °C
	SSM3K361R # \$	100	+/-20	3.5	-	-	-	-	-	92	-	69	3.2	430	T <sub>ch</sub> = 175 °C
S-MINI	SSM3K7002KF # \$	60	+/-20	0.4	-	-	-	-	-	1750	-	1500	0.39	26	
TSOP6F	XSM6K837R ★ # \$	40	+/-20	8.0	-	-	-	-	-	37	-	16	6.5	797	T <sub>ch</sub> = 175 °C
	XSM6K809R ★ # \$	60	+/-20	6.0	-	-	-	-	69	51	-	36	9.3	550	T <sub>ch</sub> = 175 °C
	XSM6K836R ★ # \$	60	+/-20	6.7	-	-	-	-	38	29	-	21	24	1328	T <sub>ch</sub> = 175 °C
	XSM6K810R ★ # \$	100	+/-20	3.5	-	-	-	-	-	92	-	69	3.2	430	T <sub>ch</sub> = 175 °C
	XSM6K819R ★ # \$	100	+/-20	10	-	-	-	-	-	36.4	-	25.8	8.5	1110	T <sub>ch</sub> = 175 °C

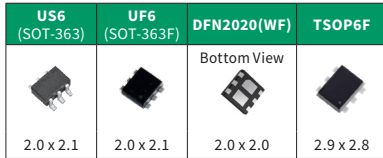

## Dual MOSFETs

Package	Circuit Configuration	Part Number	V <sub>DSS</sub> (V)	V <sub>GS</sub> (V)	I <sub>D</sub> (A)	R <sub>DS(ON)</sub> max (mΩ)								Q <sub>g</sub> typ. (nC)	C <sub>iss</sub> typ. (pF)	Note
						V <sub>GS</sub> =1.2V	V <sub>GS</sub> =1.5V	V <sub>GS</sub> =1.8V	V <sub>GS</sub> =2.5V	V <sub>GS</sub> =4.5V	V <sub>GS</sub> =10V					
DFN2020 (WF)	N-ch x2	XSM6N65NW ★ # \$	30	+20/-12	4.0	-	-	-	-	64	46	2.5	280			
		XSM6N67NW ★ # \$	30	+12/-8	4.0	-	-	82	53	39.1	-	3.2	310			
US6	N-ch x2	SSM6N7002KFU # \$	60	+/-20	0.3	-	-	-	-	1750	1500	0.39	26			
UF6	N-ch x2	SSM6N62TU # \$	20	+/-8	0.8	456	173	120	98	85	-	2.0	177			
	N-ch x2	XSM6N813R ★ # \$	100	+/-20	3.5	-	-	-	-	154	112	3.6	242	T <sub>ch</sub> = 175 °C		
TSOP6F	N-ch + P-ch	XSM6L820R ★ # \$	30	+12/-8	4.0	-	-	82	53	39.1	-	3.2	310			
			-20	-12/+6	-4.0	-	-	157	76	56	45	6.7	480			

☆ New Products

★ Under Development (The specification is subject to change without notice.)

# AEC-Q101 qualified, \$ With protection Zener diode between gate and source

## 5. Part Naming Conventions

### Small Signal MOSFET SSM / XSM Series

Ex.) SSM 3 K 329 - R  
 ① ② ③ ④ ⑤ ⑥

① Small-Signal MOSFET

SSM: Initial of "Small-Signal MOSFET"

XSM: Initial of "Automotive Small-Signal MOSFET"

② Pin count

③ Polarity and internal configuration

K: N-channel, single

J: P-channel, single

N: N-channel, dual

P: P-channel, dual

L: N-channel and P-channel (dual)

H: N-channel and SBD (or Switching diode)

G: P-channel and SBD

④ Serial number of the products

⑤ There may be a symbol that indicates chip change etc.

⑥ Package

3-pin	F:	S-Mini	(SOT-346)
	FU:	USM	(SOT-323)
	FS:	SSM	(SOT-416)
	FV:	VESM	(SOT-723)
	TU:	UFM	(SOT-323F)
	CT:	CST3	(SOT-883)
5-pin	CTC:	CST3C	
	R:	SOT-23F	
	F:	SMV	(SOT-25)
	FU:	USV	(SOT-353)
	FE:	ESV	(SOT-553)
	TU:	UFV	(SOT-353F)
6-pin	G:	WCSP6C	
	L:	TCSP6A-172101	(Chip LGA)
	R:	TSOP6F	
	FU:	US6	(SOT-363)
	FE:	ES6	(SOT-563)
	TU:	UF6	(SOT-363F)
10-pin	NU:	UDFN6 / UDFN6B	(SOT-1118) / (SOT-1220)
	NW:	DFN2020(WF) / DFN2020B(WF)	
	L:	TCSPAC-153001 / TCSPAG-341501	(Chip LGA) (Chip LGA)
14-pin	L:	TCSPED-302701	(Chip LGA)

# 6. Device Packages

## Surface Mount Type (Lead Type)

VESM (SOT-723) (1.2 x 1.2)	SSM (SOT-416) (1.6 x 1.6)	UFM (SOT-323F) (2.0 x 2.1)
<p>Package dimension unit: mm</p>	<p>Package dimension unit: mm</p>	<p>Package dimension unit: mm</p>
<p>Land pattern example unit: mm</p>	<p>Land pattern example unit: mm</p>	<p>Land pattern example unit: mm</p>
USM (SOT-323) (2.0 x 2.1)	SOT23 (SOT-23) (2.9 x 2.4)	SOT-23F (2.9 x 2.4)
<p>Package dimension unit: mm</p>	<p>Package dimension unit: mm</p>	<p>Package dimension unit: mm</p>
<p>Land pattern example unit: mm</p>	<p>Land pattern example unit: mm</p>	<p>Land pattern example unit: mm</p>
S-Mini (SOT-346) (2.9 x 2.5)	ESV (SOT-553) (1.6 x 1.6)	UFV (SOT-353F) (2.0 x 2.1)
<p>Package dimension unit: mm</p>	<p>Package dimension unit: mm</p>	<p>Package dimension unit: mm</p>
<p>Land pattern example unit: mm</p>	<p>Land pattern example unit: mm</p>	<p>Land pattern example unit: mm</p>

USV (SOT-353) (2.0 x 2.1)	SMV (SOT-25) (2.9 x 2.8)	ES6 (SOT-563) (1.6 x 1.6)
Package dimension unit: mm 	Package dimension unit: mm 	Package dimension unit: mm 
Land pattern example unit: mm 	Land pattern example unit: mm 	Land pattern example unit: mm 

UF6 (SOT-363F) (2.0 x 2.1)	US6 (SOT-363) (2.0 x 2.1)	TSOP6F (2.9 x 2.8)
Package dimension unit: mm 	Package dimension unit: mm 	Package dimension unit: mm 
Land pattern example unit: mm 	Land pattern example unit: mm 	Land pattern example unit: mm 

## Surface Mount Type (Leadless Type)

CST3 (SOT-883) (1.0 x 0.6)	CST3C (0.8 x 0.6)	UDFN6 (SOT-1118) (2.0 x 2.0)
Package dimension unit: mm 	Package dimension unit: mm 	Package dimension unit: mm 
Land pattern example unit: mm 	Land pattern example unit: mm 	Land pattern example unit: mm 

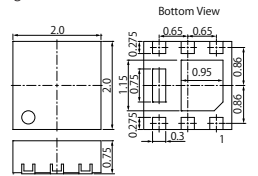
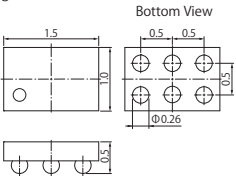
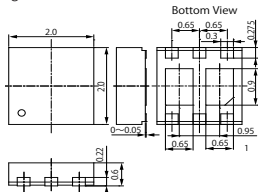
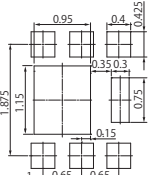
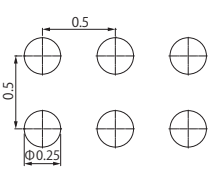
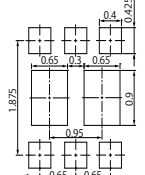
<p><b>UDFN6B (SOT-1220) (2.0 x 2.0)</b></p> <p>Package dimension unit: mm</p>  <p>Bottom View</p>	<p><b>WCSP6C (1.5 x 1.0)</b></p> <p>Package dimension unit: mm</p>  <p>Bottom View</p>	<p><b>DFN2020(WF) (2.0 x 2.0)</b></p> <p>Package dimension unit: mm</p>  <p>Bottom View</p>
<p>Land pattern example unit: mm</p> 	<p>Land pattern example unit: mm</p> 	<p>Land pattern example unit: mm</p> 

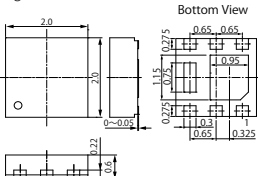
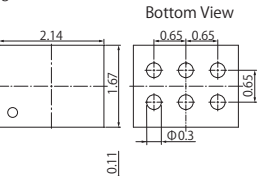
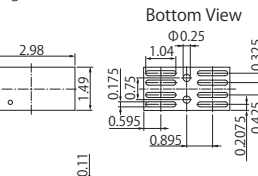
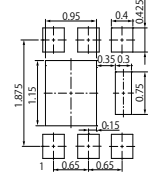
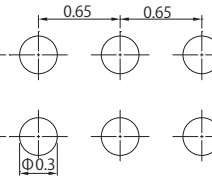
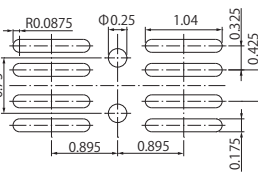
<p><b>DFN2020B(WF) (2.0 x 2.0)</b></p> <p>Package dimension unit: mm</p>  <p>Bottom View</p>	<p><b>TCSP6A-172101 (2.14 x 1.67)</b></p> <p>Package dimension unit: mm</p>  <p>Bottom View</p>	<p><b>TCSPAC-153001 (2.98 x 1.49)</b></p> <p>Package dimension unit: mm</p>  <p>Bottom View</p>
<p>Land pattern example unit: mm</p> 	<p>Land pattern example unit: mm</p> 	<p>Land pattern example unit: mm</p> 

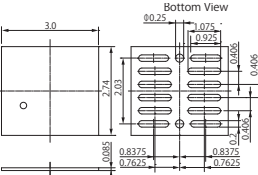
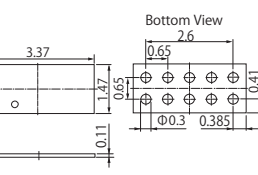
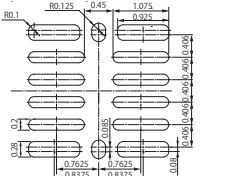
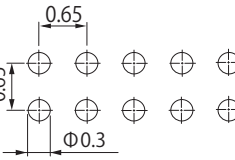
<p><b>TCSPED-302701 (3.0 x 2.74)</b></p> <p>Package dimension unit: mm</p>  <p>Bottom View</p>	<p><b>TCSPAG-341501 (3.37 x 1.47)</b></p> <p>Package dimension unit: mm</p>  <p>Bottom View</p>
<p>Land pattern example unit: mm</p> 	<p>Land pattern example unit: mm</p> 

# II Power MOSFETs

## 1. Low-Voltage MOSFET Series

TSON Advance (3.3 x 3.3)



Circuit Configuration	Part Number	Absolute Maximum Ratings			R <sub>DS(ON)</sub> max (mΩ)									Q <sub>g</sub> typ. (nC)		C <sub>iss</sub> typ. (pF)	Remark
		V <sub>DS</sub> (V)	V <sub>GES</sub> (V)	I <sub>D</sub> (A)	V <sub>GES</sub>   = 10V	V <sub>GES</sub>   = 8V	V <sub>GES</sub>   = 6.5V	V <sub>GES</sub>   = 6V	V <sub>GES</sub>   = 4.5V	V <sub>GES</sub>   = 2.5V	V <sub>GES</sub>   = 2V	V <sub>GES</sub>   = 1.8V	V <sub>GES</sub>   = 10V	V <sub>GES</sub>   = 4.5V			
N-ch Note(1)	TPN11003NL	30	+/-20	31 <sup>SL</sup>	11	-	-	-	16	-	-	-	7.5	3.3	510	U-MOSVIII-H	
	TPN8R903NL	30	+/-20	37 <sup>SL</sup>	8.9	-	-	-	12.7	-	-	-	9.8	4.4	630	U-MOSVIII-H	
	TPN6R003NL	30	+/-20	56 <sup>SL</sup>	6	-	-	-	8.3	-	-	-	17	8.2	1050	U-MOSVIII-H	
	TPN5R203PL	30	+/-20	76 <sup>SL</sup>	5.2	-	-	-	6.4	-	-	-	22	10	1520	U-MOSIX-H	
	TPN4R303NL	30	+/-20	63 <sup>SL</sup>	4.3	-	-	-	6.3	-	-	-	14.8	6.8	1110	U-MOSVIII-H	
	TPN2R903PL	30	+/-20	122 <sup>SL</sup>	2.9	-	-	-	4.1	-	-	-	26	12	1780	U-MOSIX-H	
	TPN2R703NL	30	+/-20	90 <sup>SL</sup>	2.7	-	-	-	4.1	-	-	-	21	9.5	1600	U-MOSVIII-H	
	TPN1R603PL	30	+/-20	188 <sup>SL</sup>	1.6	-	-	-	2.5	-	-	-	41	20	2970	U-MOSIX-H	
	TPN7R504PL	40	+/-20	68 <sup>SL</sup>	7.5	-	-	-	10	-	-	-	24	12	1570	U-MOSIX-H	
	TPN3R704PL	40	+/-20	92 <sup>SL</sup>	3.7	-	-	-	6	-	-	-	27	13.3	1910	U-MOSIX-H	
	TPN2R304PL	40	+/-20	100 <sup>SL</sup>	2.3	-	-	-	4	-	-	-	41	19.4	2750	U-MOSIX-H	
	TPN2R805PL	45	+/-20	139 <sup>SL</sup>	2.8	-	-	-	5	-	-	-	39	19	2450	U-MOSIX-H	
	TPN22006NH	60	+/-20	21 <sup>SL</sup>	22	-	64	-	-	-	-	-	12	-	710	U-MOSVIII-H	
	TPN14006NH	60	+/-20	33 <sup>SL</sup>	14	-	41	-	-	-	-	-	15	-	1000	U-MOSVIII-H	
	TPN11006PL	60	+/-20	54 <sup>SL</sup>	11.4	-	-	-	18.1	-	-	-	17	9	1250	U-MOSIX-H	
	TPN11006NL	60	+/-20	37 <sup>SL</sup>	11.4	-	-	-	17	-	-	-	23	11.2	1500	U-MOSVIII-H	
	TPN7R506NH	60	+/-20	53 <sup>SL</sup>	7.5	-	16	-	-	-	-	-	22	-	1410	U-MOSVIII-H	
	TPN7R006PL	60	+/-20	76 <sup>SL</sup>	7	-	-	-	13.5	-	-	-	20	9.8	1440	U-MOSIX-H	
	TPN4R806PL	60	+/-20	105 <sup>SL</sup>	4.8	-	-	-	9.1	-	-	-	29	14	2130	U-MOSIX-H	
	TPN30008NH	80	+/-20	22 <sup>SL</sup>	30	-	-	-	-	-	-	-	11	-	710	U-MOSVIII-H	
	TPN19008QM	80	+/-20	38 <sup>SL</sup>	19	-	-	28	-	-	-	-	16	9.7 (@6V)	1020	U-MOSX-H	
	TPN13008NH	80	+/-20	40 <sup>SL</sup>	13.3	-	-	-	-	-	-	-	18	-	1230	U-MOSVIII-H	
	TPN12008QM	80	+/-20	60 <sup>SL</sup>	12.3	-	-	17.7	-	-	-	-	22	13.9 (@6V)	1280	U-MOSX-H	
	TPN8R408QM	80	+/-20	77 <sup>SL</sup>	8.4	-	-	12.4	-	-	-	-	28	17 (@6V)	1750	U-MOSX-H	
	TPN3300ANH	100	+/-20	21 <sup>SL</sup>	33	-	-	-	-	-	-	-	11	-	680	U-MOSVIII-H	
	TPN1600ANH	100	+/-20	36 <sup>SL</sup>	16	-	-	-	-	-	-	-	19	-	1230	U-MOSVIII-H	
TPN1200APL	100	+/-20	66 <sup>SL</sup>	11.5	-	-	-	20	-	-	-	24	12	1425	U-MOSIX-H		
TPN5900CNH	150	+/-20	18 <sup>SL</sup>	59	-	-	-	-	-	-	-	7	-	460	U-MOSVIII-H		
TPN4800CQH	150	+/-20	29 <sup>SL</sup>	48	59	-	-	-	-	-	-	11	9 (@8V)	800	U-MOSX-H		
TPN1110ENH	200	+/-20	13 <sup>SL</sup>	114	-	-	-	-	-	-	-	7	-	460	U-MOSVIII-H		
TPN2010FNH	250	+/-20	9.9 <sup>SL</sup>	198	-	-	-	-	-	-	-	7	-	460	U-MOSVIII-H		
N-ch	TPN6R303NC	30	+/-20	43 <sup>SL</sup>	6.3	-	-	-	8.4	-	-	-	24	-	1370	U-MOSVIII	
	TPN4R203NC	30	+/-20	53 <sup>SL</sup>	4.2	-	-	-	6.4	-	-	-	24	-	1370	U-MOSVIII	
	TPN2R203NC	30	+/-20	100 <sup>SL</sup>	2.2	-	-	-	3.6	-	-	-	34	-	2230	U-MOSVIII	
P-ch	TPCC8136	-20	+/-12	-9.4	-	-	-	-	16	22	37	60	-	36 (@5V)	2350	U-MOSVI	
	TPCC8137	-20	+/-12	-13	-	-	-	-	10	16	30	52	-	43 (@5V)	2990	U-MOSVI	
	TPCC8138	-20	+/-12	-18	-	-	-	-	7.5	11	21	42	-	63 (@5V)	4165	U-MOSVI	
	TPN4R712MD	-20	+/-12	-36	-	-	-	-	4.7	8.1	-	-	-	65 (@5V)	4300	U-MOSVI	
	TPCC8131	-30	+20/-25	-10	17.6	-	-	-	23	-	-	-	-	40	-	1700	U-MOSVI
	TPCC8104	-30	+20/-25	-20	8.8	-	-	-	12.4	-	-	-	-	58	-	2260	U-MOSVI
TPCC8105	-30	+20/-25	-23	7.8	-	-	-	10.4	-	-	-	-	76	-	3240	U-MOSVI	

§ With protection Zener diode between gate and source, <sup>SL</sup> I<sub>D(DC)</sub> (Silicon Limit)  
 Note(1) : High-speed switching type



## SOP-8 (5 x 6)

Circuit Configuration	Part Number	Absolute Maximum Ratings			R <sub>DS(ON)</sub> max (mΩ)		Q <sub>g</sub> typ. (nC)		C <sub>iss</sub> typ. (pF)	Remark
		V <sub>DSS</sub> (V)	V <sub>GSS</sub> (V)	I <sub>D</sub> (A)	V <sub>GS</sub>   = 10V	V <sub>GS</sub>   = 4.5V	V <sub>GS</sub>   = 10V	V <sub>GS</sub>   = 4.5V		
N-ch Note(1)	TP89R103NL	30	+/-20	15 <sup>SL</sup>	9.1	12.9	9.8	4.4	630	U-MOSVIII-H
	TP86R203NL	30	+/-20	19 <sup>SL</sup>	6.2	8.5	17	8.2	1050	U-MOSVIII-H
P-ch	TPC8129	-30	+20/-25	-9	22	28	39	-	1650	U-MOSVI
	TPC8125	-30	+20/-25	-10	13	17	64	-	2580	U-MOSVI
	TPC8134	-40	+20/-25	-5	52	66	20	-	890	U-MOSVI
	TPC8132	-40	+20/-25	-7	25	33	34	-	1580	U-MOSVI
	TPC8133	-40	+20/-25	-9	15	18	64	-	2900	U-MOSVI



## SOP Advance (5 x 6)

Circuit Configuration	Part Number	Absolute Maximum Ratings			R <sub>DS(ON)</sub> max (mΩ)						Q <sub>g</sub> typ. (nC)		C <sub>iss</sub> typ. (pF)	Remark	
		V <sub>DSS</sub> (V)	V <sub>GSS</sub> (V)	I <sub>D</sub> (A)	V <sub>GS</sub>   = 10V	V <sub>GS</sub>   = 8V	V <sub>GS</sub>   = 6.5V	V <sub>GS</sub>   = 6V	V <sub>GS</sub>   = 4.5V	V <sub>GS</sub>   = 2.5V	V <sub>GS</sub>   = 10V	V <sub>GS</sub>   = 4.5V			
N-ch Note(1)	TPH11003NL	30	+/-20	32 <sup>SL</sup>	11	-	-	-	16	-	7.5	3.3	510	U-MOSVIII-H	
	TPH8R903NL	30	+/-20	38 <sup>SL</sup>	8.9	-	-	-	12.7	-	9.8	4.4	630	U-MOSVIII-H	
	TPH6R003NL	30	+/-20	57 <sup>SL</sup>	6	-	-	-	8.3	-	17	8.2	1050	U-MOSVIII-H	
	TPH4R803PL	30	+/-20	90 <sup>SL</sup>	4.8	-	-	-	6.2	-	22	10	1520	U-MOSIX-H	
	TPH4R003NL	30	+/-20	68 <sup>SL</sup>	4	-	-	-	6.2	-	14.8	6.8	1110	U-MOSVIII-H	
	TPH3R203NL	30	+/-20	84 <sup>SL</sup>	3.2	-	-	-	4.7	-	21	9.5	1600	U-MOSVIII-H	
	TPH3R003PL	30	+/-20	134 <sup>SL</sup>	3	-	-	-	4.2	-	50	24	2940	U-MOSIX-H	
	TPH2R903PL	30	+/-20	124 <sup>SL</sup>	2.9	-	-	-	4.1	-	26	12	1780	U-MOSIX-H	
	TPH2R003PL	30	+/-20	180 <sup>SL</sup>	2	-	-	-	2.6	-	86	41	4930	U-MOSIX-H	
	TPH1R403NL	¥	30	+/-20	150 <sup>SL</sup>	1.4	-	-	-	2.1	-	46	20	3400	U-MOSVIII-H
	TPHR9203PL	¥	30	+/-20	280 <sup>SL</sup>	0.92	-	-	-	1.29	-	81	38	5800	U-MOSIX-H
	TPHR9003NL	¥	30	+/-20	220 <sup>SL</sup>	0.9	-	-	-	1.4	-	74	32	5300	U-MOSVIII-H
	TPHR6503PL	¥	30	+/-20	393 <sup>SL</sup>	0.65	-	-	-	0.89	-	110	52	7700	U-MOSIX-H
	TPH7R204PL	40	+/-20	72 <sup>SL</sup>	7.2	-	-	-	9.7	-	24	12	1570	U-MOSIX-H	
	TPH6R004PL	40	+/-20	87 <sup>SL</sup>	6	-	-	-	8.4	-	30	15	2100	U-MOSIX-H	
	TPH3R704PL	40	+/-20	92	3.7	-	-	-	6	-	27	13.3	1910	U-MOSIX-H	
	TPH3R704PC	40	+/-20	118 <sup>SL</sup>	3.7	-	-	-	5.8	-	47	23	2780	U-MOSIX-H	
	TPH2R104PL	40	+/-20	180 <sup>SL</sup>	2.1	-	-	-	3.1	-	78	37	4790	U-MOSIX-H	
	TPH1R204PL	¥	40	+/-20	246 <sup>SL</sup>	1.24	-	-	-	2.1	-	74	34	5500	U-MOSIX-H
	TPH1R204PB	40	+/-20	240 <sup>SL</sup>	1.2	-	-	1.96	-	-	62	-	4400	U-MOSIX-H (Low Spike)	
	TPHR8504PL	¥	40	+/-20	340 <sup>SL</sup>	0.85	-	-	-	1.4	-	103	49	7370	U-MOSIX-H
	TPHR7404PU	40	+/-20	400 <sup>SL</sup>	0.74	-	-	1.17	-	-	98	62 (@6V)	6960	U-MOSIX-H (Low Spike)	
	TPH2R805PL	45	+/-20	150 <sup>SL</sup>	2.8	-	-	-	3.9	-	73	37	3980	U-MOSIX-H	
	TPH1R405PL	45	+/-20	232 <sup>SL</sup>	1.4	-	-	-	2.3	-	74	36	4830	U-MOSIX-H	
	TPH1R005PL	¥	45	+/-20	280 <sup>SL</sup>	1.04	-	-	-	1.7	-	122	59	7700	U-MOSIX-H
	TPH14006NH	60	+/-20	34 <sup>SL</sup>	14	-	33	-	-	-	16	-	1000	U-MOSVIII-H	

<sup>SL</sup> I<sub>D</sub>(DC) (Silicon Limit)

¥ The package can be selected according to your preference. For details, please contact your TOSHIBA sales representative.

Note(1) : High-speed switching type

# SOP Advance (5 x 6)



Circuit Configuration	Part Number	Absolute Maximum Ratings			R <sub>DS(ON)</sub> max (mΩ)						Q <sub>g</sub> typ. (nC)		C <sub>iss</sub> typ. (pF)	Remark	
		V <sub>DSS</sub> (V)	V <sub>GSS</sub> (V)	I <sub>B</sub> (A)	V <sub>GS</sub>   = 10 V	V <sub>GS</sub>   = 8 V	V <sub>GS</sub>   = 6.5 V	V <sub>GS</sub>   = 6 V	V <sub>GS</sub>   = 4.5 V	V <sub>GS</sub>   = 2.5 V	V <sub>GS</sub>   = 10 V	V <sub>GS</sub>   = 4.5 V			
N-ch Note(1)	TPH11006NL	60	+/-20	40 <sup>SL</sup>	11.4	-	-	-	17	-	23	11.2	1500	U-MOSVIII-H	
	TPH9R506PL	60	+/-20	68 <sup>SL</sup>	9.5	-	-	-	15	-	21	11	1470	U-MOSIX-H	
	TPH7R506NH	60	+/-20	55 <sup>SL</sup>	7.5	-	19	-	-	-	31	-	1785	U-MOSVIII-H	
	TPH7R006PL	60	+/-20	79 <sup>SL</sup>	7	-	-	-	13.5	-	22	11	1440	U-MOSIX-H	
	TPH5R906NH	60	+/-20	71 <sup>SL</sup>	5.9	-	14	-	-	-	38	-	2340	U-MOSVIII-H	
	TPH4R606NH	60	+/-20	85 <sup>SL</sup>	4.6	-	11	-	-	-	49	-	3050	U-MOSVIII-H	
	TPH3R506PL	60	+/-20	135 <sup>SL</sup>	3.5	-	-	-	6.7	-	55	27	3400	U-MOSIX-H	
	TPH2R506PL	¥	60	+/-20	160 <sup>SL</sup>	2.5	-	-	-	4.4	-	60	32	4180	U-MOSIX-H
	TPH2R306NH	¥	60	+/-20	130 <sup>SL</sup>	2.3	-	4.7	-	-	-	72	-	4700	U-MOSVIII-H
	TPH1R306PL	¥	60	+/-20	260 <sup>SL</sup>	1.34	-	-	-	2.3	-	91	44	6250	U-MOSIX-H
	TPH1R306P1		60	+/-20	260 <sup>SL</sup>	1.28	-	-	-	2.3	-	91	44	6250	U-MOSIX-H (Low Spike)
	TPH2R608NH		75	+/-20	168 <sup>SL</sup>	2.6	-	-	-	-	-	72	-	4600	U-MOSVIII-H
	TPH12008NH		80	+/-20	44 <sup>SL</sup>	12.3	-	-	-	-	-	22	-	1490	U-MOSVIII-H
	TPH8R008NH		80	+/-20	63 <sup>SL</sup>	8	-	-	-	-	-	35	-	2300	U-MOSVIII-H
	TPH4R008NH	¥	80	+/-20	100 <sup>SL</sup>	4	-	-	-	-	-	59	-	4100	U-MOSVIII-H
	TPH2R408QM	¥	80	+/-20	200 <sup>SL</sup>	2.43	-	-	3.5	-	-	87	55 (@6V)	5870	U-MOSX-H
	TPH1400ANH		100	+/-20	42 <sup>SL</sup>	13.6	-	-	-	-	-	22	-	1440	U-MOSVIII-H
	TPH8R80ANH		100	+/-20	59 <sup>SL</sup>	8.8	-	-	-	-	-	33	-	2180	U-MOSVIII-H
	TPH6R30ANL	§	100	+/-20	66 <sup>SL</sup>	6.3	-	-	-	10.3	-	55	27	3300	U-MOSVIII-H
	TPH5R60APL		100	+/-20	110 <sup>SL</sup>	5.6	-	-	-	9.5	-	52	26	3300	U-MOSIX-H
	TPH4R50ANH	¥	100	+/-20	93 <sup>SL</sup>	4.5	-	-	-	-	-	58	-	4000	U-MOSVIII-H
	TPH4R10ANL		100	+/-20	92 <sup>SL</sup>	4.1	-	-	-	6.6	-	75	37	4850	U-MOSVIII-H
	TPH3R70APL	¥	100	+/-20	150 <sup>SL</sup>	3.7	-	-	-	6.2	-	67	33	4850	U-MOSIX-H
	TPH5900CNH		150	+/-20	18 <sup>SL</sup>	59	-	-	-	-	-	7	-	460	U-MOSVIII-H
	TPH3300CNH		150	+/-20	29 <sup>SL</sup>	33	-	-	-	-	-	10.6	-	810	U-MOSVIII-H
	TPH1500CNH	¥	150	+/-20	50 <sup>SL</sup>	15.4	-	-	-	-	-	22	-	1700	U-MOSVIII-H
	TPH9R00CQH	¥	150	+/-20	108 <sup>SL</sup>	9	11	-	-	-	-	44	36 (@8V)	3500	U-MOSX-H
	TPH1110ENH		200	+/-20	13 <sup>SL</sup>	114	-	-	-	-	-	7	-	460	U-MOSVIII-H
	TPH6400ENH		200	+/-20	21 <sup>SL</sup>	64	-	-	-	-	-	11.2	-	810	U-MOSVIII-H
	TPH2900ENH		200	+/-20	36 <sup>SL</sup>	29	-	-	-	-	-	22	-	1700	U-MOSVIII-H
TPH2010FNH		250	+/-20	10 <sup>SL</sup>	198	-	-	-	-	-	7	-	460	U-MOSVIII-H	
TPH1110FNH		250	+/-20	15 <sup>SL</sup>	112	-	-	-	-	-	11	-	810	U-MOSVIII-H	
TPH5200FNH		250	+/-20	27 <sup>SL</sup>	52	-	-	-	-	-	22	-	1700	U-MOSVIII-H	
N-ch	TPHR9003NC	30	+/-20	220 <sup>SL</sup>	0.9	-	-	-	1.4	-	75	32	5300	U-MOSVIII	
P-ch	TPH1R712MD	-20	+/-12	-60	-	-	-	-	1.7	2.7	-	182 (@5V)	10900	U-MOSVI	
	TPCA8131	-30	+20/-25	-13	17	-	-	-	22	-	40	-	1700	U-MOSVI	
	TPCA8128	-30	+20/-25	-34	4.8	-	-	-	6.7	-	115	-	4800	U-MOSVI	
	TPCA8120	-30	+20/-25	-45	3	-	-	-	4	-	190	-	7420	U-MOSVI	

<sup>SL</sup> I<sub>D(PC)</sub> (Silicon Limit)

§ With protection Zener diode between gate and source

¥ The package can be selected according to your preference. For details, please contact your TOSHIBA sales representative.

Note(1) : High-speed switching type



# SOP Advance (N) (4.9 x 6.1)

Circuit Configuration	Part Number	Absolute Maximum Ratings			R <sub>DS(ON)</sub> max (mΩ)						Q <sub>g</sub> typ. (nC)		C <sub>iss</sub> typ. (pF)	R <sub>th</sub> (ch-c) max (°C/W)	Remark
		V <sub>DSS</sub> (V)	V <sub>CESS</sub> (V)	I <sub>D</sub> (A)	V <sub>GS</sub>   = 10V	V <sub>GS</sub> = 8V	V <sub>GS</sub>   = 6.5V	V <sub>GS</sub>   = 6V	V <sub>GS</sub>   = 4.5V	V <sub>GS</sub>   = 2.5V	V <sub>GS</sub>   = 10V	V <sub>GS</sub>   = 4.5V			
N-ch Note(1)	TPH1R403NL1	30	+/-20	230 <sup>SL</sup>	1.4	-	-	-	2.1	-	46	20	3400	0.88	U-MOSVIII-H
	TPH1R403NL ¥	30	+/-20	150 <sup>SL</sup>	1.4	-	-	-	2.1	-	46	20	3400	0.95	U-MOSVIII-H
	TPHR9203PL1	30	+/-20	320 <sup>SL</sup>	0.92	-	-	-	1.29	-	81	38	5800	0.88	U-MOSIX-H
	TPHR9203PL ¥	30	+/-20	280 <sup>SL</sup>	0.92	-	-	-	1.29	-	81	38	5800	1.13	U-MOSIX-H
	TPHR9003NL1	30	+/-20	320 <sup>SL</sup>	0.9	-	-	-	1.4	-	74	32	5300	0.71	U-MOSVIII-H
	TPHR9003NL ¥	30	+/-20	220 <sup>SL</sup>	0.9	-	-	-	1.4	-	74	32	5300	1.6	U-MOSVIII-H
	TPHR6503PL1	30	+/-20	420 <sup>SL</sup>	0.65	-	-	-	0.89	-	110	52	7700	0.71	U-MOSIX-H
	TPHR6503PL ¥	30	+/-20	393 <sup>SL</sup>	0.65	-	-	-	0.89	-	110	52	7700	0.88	U-MOSIX-H
	TPH1R204PL1	40	+/-20	270 <sup>SL</sup>	1.24	-	-	-	2.1	-	74	34	5500	0.88	U-MOSIX-H
	TPH1R204PL ¥	40	+/-20	246 <sup>SL</sup>	1.24	-	-	-	2.1	-	74	34	5500	1.13	U-MOSIX-H
	TPHR8504PL1	40	+/-20	370 <sup>SL</sup>	0.85	-	-	-	1.4	-	103	49	7370	0.71	U-MOSIX-H
	TPHR8504PL ¥	40	+/-20	340 <sup>SL</sup>	0.85	-	-	-	1.4	-	103	49	7370	0.88	U-MOSIX-H
	TPHR6704RL ☆	40	+/-20	420	0.67	-	-	-	0.97	-	88	43	5990	0.71	U-MOS11-H
	TPH1R005PL ¥	45	+/-20	280 <sup>SL</sup>	1.04	-	-	-	1.7	-	122	59	7700	0.88	U-MOSIX-H
	TPH2R506PL ¥	60	+/-20	160 <sup>SL</sup>	2.5	-	-	-	4.4	-	60	32	4180	1.13	U-MOSIX-H
	TPH2R306PL1	60	+/-20	190 <sup>SL</sup>	2.3	-	-	-	4.2	-	60	32	4180	0.88	U-MOSIX-H
	TPH2R306NH1	60	+/-20	190 <sup>SL</sup>	2.3	-	4.7	-	-	-	72	-	4700	0.71	U-MOSVIII-H
	TPH2R306NH ¥	60	+/-20	130 <sup>SL</sup>	2.3	-	4.7	-	-	-	72	-	4700	1.6	U-MOSVIII-H
	TPH1R906PU ☆	60	+/-20	207	1.91	-	-	-	5.4	-	57	29	3770	0.88	U-MOSIX-H
	TPH1R306PL1	60	+/-20	280 <sup>SL</sup>	1.34	-	-	-	2.3	-	91	44	6250	0.71	U-MOSIX-H
	TPH1R306PL ¥	60	+/-20	260 <sup>SL</sup>	1.34	-	-	-	2.3	-	91	44	6250	0.88	U-MOSIX-H
	TPH8R808QM	80	+/-20	79 <sup>SL</sup>	8.8	-	-	12.5	-	-	26	16 (@6V)	1750	1.37	U-MOSX-H
	TPH6R008QM	80	+/-20	107 <sup>SL</sup>	6	-	-	8.4	-	-	38	30 (@6V)	2500	1.11	U-MOSX-H
	TPH4R008QM	80	+/-20	140 <sup>SL</sup>	4	-	-	5.6	-	-	57	35 (@6V)	3750	0.88	U-MOSX-H
	TPH4R008NH1	80	+/-20	146 <sup>SL</sup>	4	-	-	-	-	-	59	-	4100	0.71	U-MOSVIII-H
	TPH4R008NH ¥	80	+/-20	100 <sup>SL</sup>	4	-	-	-	-	-	59	-	4100	1.6	U-MOSVIII-H
	TPH3R008QM	80	+/-20	170 <sup>SL</sup>	3	-	-	4.3	-	-	71	44 (@6V)	5090	0.8	U-MOSX-H
	TPH2R408QM ¥	80	+/-20	200 <sup>SL</sup>	2.43	-	-	3.5	-	-	87	55 (@6V)	5870	0.71	U-MOSX-H
	TPH4R50ANH1	100	+/-20	138 <sup>SL</sup>	4.5	-	-	-	-	-	58	-	4000	0.71	U-MOSVIII-H
	TPH4R50ANH ¥	100	+/-20	93 <sup>SL</sup>	4.5	-	-	-	-	-	58	-	4000	1.6	U-MOSVIII-H
	TPH3R70APL1	100	+/-20	170 <sup>SL</sup>	3.7	-	-	-	6.2	-	67	33	4850	0.71	U-MOSIX-H
	TPH3R70APL ¥	100	+/-20	150 <sup>SL</sup>	3.7	-	-	-	6.2	-	67	33	4850	0.88	U-MOSIX-H
	TPH3R10AQM	100	+/-20	180 <sup>SL</sup>	3.1	-	-	6	-	-	83	53 (@6V)	5180	0.71	U-MOSX-H
	TPH2R70AR5 ☆ &	100	+/-20	190	2.7	3.6	-	-	-	-	52	43 (@8V)	4105	0.71	U-MOS11-H
	TPH1500CNH1	150	+/-20	74 <sup>SL</sup>	15.4	-	-	-	-	-	22	-	1700	0.71	U-MOSVIII-H
	TPH1500CNH ¥	150	+/-20	50 <sup>SL</sup>	15.4	-	-	-	-	-	22	-	1700	1.6	U-MOSVIII-H
	TPH1400CQH	150	+/-20	77 <sup>SL</sup>	14.1	17.3	-	-	-	-	31	25 (@8V)	2400	0.88	U-MOSX-H
	TPH1400CQ5 &	150	+/-20	77 <sup>SL</sup>	14.1	17.3	-	-	-	-	31	25 (@8V)	2400	0.88	U-MOSX-H (HSD)
	TPH1100CQ5 &	150	+/-20	90 <sup>SL</sup>	11.1	13.6	-	-	-	-	38	31 (@8V)	2830	0.8	U-MOSX-H (HSD)
	TPH9R00CQH ¥	150	+/-20	108 <sup>SL</sup>	9	11	-	-	-	-	44	36 (@8V)	3500	0.71	U-MOSX-H
TPH9R00CQ5 &	150	+/-20	108 <sup>SL</sup>	9	11	-	-	-	-	44	36 (@8V)	3500	0.71	U-MOSX-H (HSD)	

<sup>SL</sup> I<sub>D</sub> (DC) (Silicon Limit), ☆ New Products, & High Speed Diode type  
 ¥ The package can be selected according to your preference. For details, please contact your TOSHIBA sales representative.  
 Note(1) : High-speed switching type



## SOP Advance (E) ( 4.9 x 6.1 )

Circuit Configuration	Part Number	Absolute Maximum Ratings			R <sub>DS(ON)</sub> max (mΩ)				Q <sub>g</sub> typ. (nC)		C <sub>iss</sub> typ. (pF)	R <sub>th</sub> (ch-c) max (°C / W)	Remark
		V <sub>DSS</sub> (V)	V <sub>GSS</sub> (V)	I <sub>D</sub> (A)	V <sub>GS</sub>   = 10 V	V <sub>GS</sub>   = 8 V	V <sub>GS</sub>   = 6 V	V <sub>GS</sub>   = 4.5 V	V <sub>GS</sub>   = 10 V	V <sub>GS</sub>   = 4.5 V			
N-ch Note(1)	TPMR4904RL ☆	40	+/-20	497	0.49	-	-	0.83	107	51	7430	0.6	U-MOS11-H
	TPM1R006PL ☆	60	+/-20	341	1	-	-	2.3	106	54	6890	0.6	U-MOSIX-H
	TPM3R708QM ☆	80	+/-20	140	3.7	-	5.4	-	57	35 (@6 V)	3750	0.88	U-MOSX-H
	TPM2R808QM ☆	80	+/-20	168	2.8	-	4.2	-	71	44 (@6 V)	5090	0.72	U-MOSX-H
	TPM2R408QM ☆	80	+/-20	205	2.4	-	3.5	-	87	55 (@6 V)	5870	0.68	U-MOSX-H
	TPM1R908QM ☆	80	+/-20	238	1.9	-	2.8	-	108	66 (@6 V)	7360	0.6	U-MOSX-H
	TPM1R408RH ☆	80	+/-20	288	1.4	1.7	-	-	80	65 (@8V)	5870	0.6	U-MOS11-H
	TPM7R10CQ5 ☆ &	150	+/-20	120	7.1	8.7	-	-	57	46 (@8 V)	4390	0.6	U-MOSX-H

☆ New Products, & High Speed Diode type  
 Note(1) : High-speed switching type



## DSOP Advance ( 5 x 6 )

Circuit Configuration	Part Number	Absolute Maximum Ratings			R <sub>DS(ON)</sub> max (mΩ)			Q <sub>g</sub> typ. (nC)		C <sub>iss</sub> typ. (pF)	Remark
		V <sub>DSS</sub> (V)	V <sub>GSS</sub> (V)	I <sub>D</sub> (A)	V <sub>GS</sub>   = 10 V	V <sub>GS</sub>   = 4.5 V	V <sub>GS</sub>   = 10 V	V <sub>GS</sub>   = 4.5 V			
N-ch Note(1)	TPWR8503NL	30	+/-20	300 <sup>SL</sup>	0.85	1.3	74	32	5300	U-MOSVIII-H	
	TPWR6003PL	30	+/-20	412 <sup>SL</sup>	0.6	0.84	110	52	7700	U-MOSIX-H	
	TPWR8004PL	40	+/-20	340 <sup>SL</sup>	0.8	1.35	103	49	7370	U-MOSIX-H	
	TPW1R005PL	45	+/-20	300 <sup>SL</sup>	0.99	1.65	122	59	7700	U-MOSIX-H	
	TPW1R306PL	60	+/-20	260 <sup>SL</sup>	1.29	2.3	91	44	6250	U-MOSIX-H	
	TPW2R508NH	75	+/-20	170 <sup>SL</sup>	2.5	-	72	-	4600	U-MOSVIII-H	
	TPW4R008NH	80	+/-20	116	4	-	59	-	4100	U-MOSVIII-H	
	TPW4R50ANH	100	+/-20	92	4.5	-	58	-	4000	U-MOSVIII-H	
	TPW3R70APL	100	+/-20	150 <sup>SL</sup>	3.7	6.2	67	33	4850	U-MOSIX-H	
	TPW1500CNH	150	+/-20	50 <sup>SL</sup>	15.4	-	22	-	1700	U-MOSVIII-H	
TPW2900ENH	200	+/-20	36 <sup>SL</sup>	29	-	22	-	1700	U-MOSVIII-H		
TPW5200FNH	250	+/-20	27 <sup>SL</sup>	52	-	22	-	1700	U-MOSVIII-H		

## DPAK



Circuit Configuration	Part Number	Absolute Maximum Ratings			R <sub>DS(ON)</sub> max (mΩ)			Q <sub>g</sub> typ. (nC)		C <sub>iss</sub> typ. (pF)	Remark
		V <sub>DSS</sub> (V)	V <sub>GSS</sub> (V)	I <sub>D</sub> (A)	V <sub>GS</sub>   = 10 V	V <sub>GS</sub>   = 6 V	V <sub>GS</sub>   = 4.5 V	V <sub>GS</sub>   = 10 V	V <sub>GS</sub>   = 4.5 V		
N-ch Note(1)	TK3R1P04PL	40	+/-20	130 <sup>SL</sup>	3.1	-	4.3	60	30	4670	U-MOSIX-H
	TK6R7P06PL	60	+/-20	74 <sup>SL</sup>	6.7	-	11.1	26	13	1990	U-MOSIX-H
	TK4R4P06PL	60	+/-20	106 <sup>SL</sup>	4.4	-	7.1	48.2	23.9	3280	U-MOSIX-H
	TK6R9P08QM	80	+/-20	83 <sup>SL</sup>	6.9	9.6	-	39	24 (@6 V)	2700	U-MOSX-H
	TK5R1P08QM	80	+/-20	105 <sup>SL</sup>	5.1	7	-	56	34 (@6 V)	3980	U-MOSX-H
	TK110P10PL	100	+/-20	60 <sup>SL</sup>	10.6	-	16	33	17	2040	U-MOSIX-H
	TK7R7P10PL	100	+/-20	79 <sup>SL</sup>	7.7	-	11.5	44	21	2800	U-MOSIX-H
P-ch	TJ15P04M3	-40	+/-20	-15	36	-	48	26	-	1100	U-MOSVI

<sup>SL</sup> I<sub>D</sub>(DC) (Silicon Limit)

Note(1) : High-speed switching type

TO-220



Circuit Configuration	Part Number	Absolute Maximum Ratings			R <sub>DS(ON)</sub> max (mΩ)				Q <sub>g</sub> typ. (nC)		C <sub>iss</sub> typ. (pF)	Remark	
		V <sub>DSS</sub> (V)	V <sub>GSS</sub> (V)	I <sub>D</sub> (A)	V <sub>GS</sub>   = 10 V	V <sub>GS</sub>   = 8 V	V <sub>GS</sub>   = 6 V	V <sub>GS</sub>   = 4.5 V	V <sub>GS</sub>   = 10 V	V <sub>GS</sub>   = 4.5 V			
N-ch Note(1)	TK3R1E04PL	40	+/-20	128 <sup>SL</sup>	3.1	-	-	3.8	63.4	29.7	4670	U-MOSIX-H	
	TK30E06N1	60	+/-20	43 <sup>SL</sup>	15	-	-	-	16	-	1050	U-MOSVIII-H	
	TK40E06N1	60	+/-20	60 <sup>SL</sup>	10.4	-	-	-	23	-	1700	U-MOSVIII-H	
	TK8R2E06PL	60	+/-20	75 <sup>SL</sup>	8.2	-	-	11.4	28	15	1990	U-MOSIX-H	
	TK58E06N1	60	+/-20	105 <sup>SL</sup>	5.4	-	-	-	46	-	3400	U-MOSVIII-H	
	TK5R1E06PL	60	+/-20	98 <sup>SL</sup>	5.1	-	-	8.8	36	18	2380	U-MOSIX-H	
	TK4R3E06PL	60	+/-20	106 <sup>SL</sup>	4.3	-	-	7.2	48.2	23.9	3280	U-MOSIX-H	
	TK3R2E06PL	60	+/-20	160 <sup>SL</sup>	3.2	-	-	4.7	71	35	5000	U-MOSIX-H	
	TK100E06N1	60	+/-20	263 <sup>SL</sup>	2.3	-	-	-	140	-	10500	U-MOSVIII-H	
	TK7R0E08QM	80	+/-20	82 <sup>SL</sup>	7	-	9.7	-	39	24 (@6V)	2700	U-MOSX-H	
	TK5R3E08QM	80	+/-20	126 <sup>SL</sup>	5.3	-	7.3	-	55	33 (@6V)	3980	U-MOSX-H	
	TK3R3E08QM	80	+/-20	200 <sup>SL</sup>	3.3	-	4.2	-	110	67 (@6V)	7670	U-MOSX-H	
	TK2R4E08QM	80	+/-20	290 <sup>SL</sup>	2.44	-	3.2	-	178	109 (@6V)	13000	U-MOSX-H	
	TK22E10N1	100	+/-20	52 <sup>SL</sup>	13.8	-	-	-	28	-	1800	U-MOSVIII-H	
	TK110E10PL	100	+/-20	64 <sup>SL</sup>	10.7	-	-	16	33	17	2040	U-MOSIX-H	
	TK34E10N1	100	+/-20	75 <sup>SL</sup>	9.5	-	-	-	38	-	2600	U-MOSVIII-H	
	TK40E10N1	100	+/-20	90 <sup>SL</sup>	8.2	-	-	-	49	-	3000	U-MOSVIII-H	
	TK7R2E10PL	100	+/-20	94 <sup>SL</sup>	7.2	-	-	11	44	21	2800	U-MOSIX-H	
	TK6R4E10PL	100	+/-20	112 <sup>SL</sup>	6.4	-	-	9.7	58	30	3455	U-MOSIX-H	
	TK65E10N1	100	+/-20	148 <sup>SL</sup>	4.8	-	-	-	81	-	5400	U-MOSVIII-H	
	TK3R9E10PL	100	+/-20	180 <sup>SL</sup>	3.9	-	-	5.8	96	49	6320	U-MOSIX-H	
	TK100E10N1	100	+/-20	207 <sup>SL</sup>	3.4	-	-	-	140	-	8800	U-MOSVIII-H	
	TK2R9E10PL	100	+/-20	240 <sup>SL</sup>	2.9	-	-	4.1	161	83	9500	U-MOSIX-H	
	TK32E12N1	120	+/-20	60 <sup>SL</sup>	13.8	-	-	-	34	-	2000	U-MOSVIII-H	
	TK42E12N1	120	+/-20	88 <sup>SL</sup>	9.4	-	-	-	52	-	3100	U-MOSVIII-H	
	TK56E12N1	120	+/-20	112 <sup>SL</sup>	7	-	-	-	69	-	4200	U-MOSVIII-H	
	TK72E12N1	120	+/-20	179 <sup>SL</sup>	4.4	-	-	-	130	-	8100	U-MOSVIII-H	
	TK9R6E15Q5	&	150	+/-20	104 <sup>SL</sup>	9.6	11.5	-	-	50	40 (@8V)	3690	U-MOSX-H (HSD)
	TK7R2E15Q5	&	150	+/-20	130 <sup>SL</sup>	7.2	8.7	-	-	66	54 (@8V)	4970	U-MOSX-H (HSD)
	TK4R9E15Q5	&	150	+/-20	180 <sup>SL</sup>	4.9	5.9	-	-	96	78 (@8V)	7820	U-MOSX-H (HSD)

<sup>SL</sup> I<sub>D</sub>(DC) (Silicon Limit)  
& High Speed Diode type  
Note(1) : High-speed switching type



# TO-220SIS

Circuit Configuration	Part Number	Absolute Maximum Ratings			R <sub>DS(ON)</sub> max (mΩ)				Q <sub>g</sub> typ. (nC)		C <sub>iss</sub> typ. (pF)	Remark	
		V <sub>DSS</sub> (V)	V <sub>GSS</sub> (V)	I <sub>D</sub> (A)	V <sub>GS</sub>   = 10V	V <sub>GS</sub>   = 8V	V <sub>GS</sub>   = 6V	V <sub>GS</sub>   = 4.5V	V <sub>GS</sub>   = 10V	V <sub>GS</sub>   = 4.5V			
N-ch Note(1)	TK3R1A04PL	40	+/-20	82	3.1	-	-	3.8	63.4	29.7	4670	U-MOSIX-H	
	TK30A06N1	60	+/-20	43 <sup>SL</sup>	15	-	-	-	16	-	1050	U-MOSVIII-H	
	TK40A06N1	60	+/-20	60 <sup>SL</sup>	10.4	-	-	-	23	-	1700	U-MOSVIII-H	
	TK8R2A06PL	60	+/-20	50	8.2	-	-	11.4	28	15	1990	U-MOSIX-H	
	TK58A06N1	60	+/-20	105 <sup>SL</sup>	5.4	-	-	-	46	-	3400	U-MOSVIII-H	
	TK5R3A06PL	60	+/-20	62 <sup>SL</sup>	5.3	-	-	9.3	36	18	2380	U-MOSIX-H	
	TK4R3A06PL	60	+/-20	68	4.3	-	-	7.2	48.2	23.9	3280	U-MOSIX-H	
	TK3R3A06PL	60	+/-20	88 <sup>SL</sup>	3.3	-	-	4.9	71	35	5000	U-MOSIX-H	
	TK100A06N1	60	+/-20	263 <sup>SL</sup>	2.7	-	-	-	140	-	10500	U-MOSVIII-H	
	TK6R8A08QM	80	+/-20	58	6.8	-	9.5	-	39	23 (@6V)	2700	U-MOSX-H	
	TK5R1A08QM	80	+/-20	71 <sup>SL</sup>	5.1	-	7.1	-	54	32 (@6V)	3980	U-MOSX-H	
	TK3R2A08QM	80	+/-20	92	3.2	-	4.1	-	102	58 (@6V)	7670	U-MOSX-H	
	TK2R4A08QM	80	+/-20	116 <sup>SL</sup>	2.44	-	3.1	-	179	102 (@6V)	13000	U-MOSX-H	
	TK22A10N1	100	+/-20	52 <sup>SL</sup>	13.8	-	-	-	28	-	1800	U-MOSVIII-H	
	TK110A10PL	100	+/-20	41 <sup>SL</sup>	10.8	-	-	16	33	17	2040	U-MOSIX-H	
	TK34A10N1	100	+/-20	75 <sup>SL</sup>	9.5	-	-	-	38	-	2600	U-MOSVIII-H	
	TK40A10N1	100	+/-20	90 <sup>SL</sup>	8.2	-	-	-	49	-	3000	U-MOSVIII-H	
	TK7R4A10PL	100	+/-20	50	7.4	-	-	11.2	44	21	2800	U-MOSIX-H	
	TK6R7A10PL	100	+/-20	56	6.7	-	-	10.1	58	30	3455	U-MOSIX-H	
	TK65A10N1	100	+/-20	148 <sup>SL</sup>	4.8	-	-	-	81	-	5400	U-MOSVIII-H	
	TK4R1A10PL	100	+/-20	85 <sup>SL</sup>	4.1	-	-	5.9	104	53	6320	U-MOSIX-H	
	TK100A10N1	100	+/-20	207 <sup>SL</sup>	3.8	-	-	-	140	-	8800	U-MOSVIII-H	
	TK3R2A10PL	100	+/-20	106 <sup>SL</sup>	3.2	-	-	4.3	161	83	9500	U-MOSIX-H	
	TK32A12N1	120	+/-20	60 <sup>SL</sup>	13.8	-	-	-	34	-	2000	U-MOSVIII-H	
	TK42A12N1	120	+/-20	88 <sup>SL</sup>	9.4	-	-	-	52	-	3100	U-MOSVIII-H	
	TK56A12N1	120	+/-20	112 <sup>SL</sup>	7.5	-	-	-	69	-	4200	U-MOSVIII-H	
	TK72A12N1	120	+/-20	179 <sup>SL</sup>	4.5	-	-	-	130	-	8100	U-MOSVIII-H	
	TK9R7A15Q5	&	150	+/-20	49 <sup>SL</sup>	9.7	11.6	-	-	50	40 (@8V)	3690	U-MOSX-H (HSD)
	TK7R4A15Q5	&	150	+/-20	57 <sup>SL</sup>	7.4	8.8	-	-	66	54 (@8V)	4970	U-MOSX-H (HSD)
	TK5R0A15Q5	&	150	+/-20	76 <sup>SL</sup>	5	6	-	-	96	78 (@8V)	7820	U-MOSX-H (HSD)

<sup>SL</sup> I<sub>D</sub>(DC) (Silicon Limit)  
 Note(1) : High-speed switching type  
 & High Speed Diode type

## 2. Mid-High Voltage MOSFET Series



### DPAK

Circuit Configuration	Part Number	Absolute Maximum Ratings			R <sub>DS(ON)</sub> max (Ω)	Q <sub>s</sub> typ. (nC)	C <sub>iss</sub> typ. (pF)	Remark
		V <sub>DSS</sub> (V)	V <sub>GSS</sub> (V)	I <sub>D</sub> (A)	V <sub>GS</sub> = 10 V			
N-ch	TK10P50W	500	+/-30	9.7	0.43	20	700	DTMOSIV
	TK12P50W	500	+/-30	11.5	0.34	25	890	DTMOSIV
	TK6P60W	600	+/-30	6.2	0.82	12	390	DTMOSIV
	TK7P60W5 &	600	+/-30	7	0.67	16	490	DTMOSIV(HSD)
	TK7P60W	600	+/-30	7	0.6	15	490	DTMOSIV
	TK560P60Y	600	+/-30	7	0.56	14.5	380	DTMOSV
	TK8P60W5 &	600	+/-30	8	0.56	22	590	DTMOSIV(HSD)
	TK8P60W	600	+/-30	8	0.5	18.5	570	DTMOSIV
	TK10P60W	600	+/-30	9.7	0.43	20	700	DTMOSIV
	TK380P60Y	600	+/-30	9.7	0.38	20	590	DTMOSV
	TK12P60W	600	+/-30	11.5	0.34	25	890	DTMOSIV
	TK290P60Y	600	+/-30	11.5	0.29	25	730	DTMOSV
	TK6P65W	650	+/-30	5.8	1.05	11	390	DTMOSIV
	TK7P65W	650	+/-30	6.8	0.8	15	490	DTMOSIV
	TK8P65W	650	+/-30	7.8	0.67	16	570	DTMOSIV
	TK560P65Y	650	+/-30	7	0.56	14.5	380	DTMOSV
	TK9P65W	650	+/-30	9.3	0.56	20	700	DTMOSIV
	TK11P65W	650	+/-30	11.1	0.44	25	890	DTMOSIV
	TK380P65Y	650	+/-30	9.7	0.38	20	590	DTMOSV
	TK290P65Y	650	+/-30	11.5	0.29	25	730	DTMOSV

& High Speed Diode type



# DFN8x8

Circuit Configuration	Part Number	Absolute Maximum Ratings			R <sub>DS(ON)</sub> max (Ω)	Q <sub>g</sub> typ. (nC)	C <sub>iss</sub> typ. (pF)	Remark
		V <sub>DSS</sub> (V)	V <sub>GSS</sub> (V)	I <sub>D</sub> (A)	V <sub>GS</sub> = 10 V			
N-ch	TK10V60W	600	+/-30	9.7	0.38	20	700	DTMOSIV
	TK12V60W	600	+/-30	11.5	0.3	25	890	DTMOSIV
	TK16V60W5 &	600	+/-30	15.8	0.245	43	1350	DTMOSIV(HSD)
	TK200V60Z1 ☆	600	+/-30	14	0.2	20	1060	DTMOSVI
	TK16V60W	600	+/-30	15.8	0.19	38	1350	DTMOSIV
	TK20V60W5 &	600	+/-30	20	0.19	55	1800	DTMOSIV(HSD)
	TK20V60W	600	+/-30	20	0.17	48	1680	DTMOSIV
	TK165V60Z1	600	+/-30	16	0.165	24	1350	DTMOSVI
	TK165V60Z5 ☆ &	600	+/-30	16	0.165	26	1410	DTMOSVI(HSD)
	TK25V60X5 &	600	+/-30	25	0.15	60	2400	DTMOSIV-H(HSD)
	TK25V60X	600	+/-30	25	0.135	40	2400	DTMOSIV-H
	TK130V60Z5 ☆ &	600	+/-30	20	0.13	30	1640	DTMOSVI(HSD)
	TK130V60Z1	600	+/-30	18	0.13	28	1620	DTMOSVI
	TK31V60W5 &	600	+/-30	30.8	0.109	105	3000	DTMOSIV(HSD)
	TK105V60Z1 ☆	600	+/-30	24	0.105	36	2050	DTMOSVI
	TK31V60W	600	+/-30	30.8	0.098	86	3000	DTMOSIV
	TK31V60X	600	+/-30	30.8	0.098	65	3000	DTMOSIV-H
	TK085V60Z1	600	+/-30	30	0.085	43	2510	DTMOSVI
	TK077V60Z5 ☆ &	600	+/-30	32	0.077	50	2860	DTMOSVI(HSD)
	TK058V60Z5 ☆ &	600	+/-30	40	0.058	66	3750	DTMOSVI(HSD)
	TK057V60Z1 ☆	600	+/-30	40	0.057	65	3680	DTMOSVI
	TK14V65W	650	+/-30	13.7	0.28	35	1300	DTMOSIV
	TK210V65Z	650	+/-30	15	0.21	25	1370	DTMOSVI
	TK17V65W	650	+/-30	17.3	0.21	45	1800	DTMOSIV
	TK200V65Z5 &	650	+/-30	15	0.2	26	1400	DTMOSVI(HSD)
	TK170V65Z	650	+/-30	18	0.17	29	1635	DTMOSVI
	TK22V65X5 &	650	+/-30	22	0.17	50	2400	DTMOSIV-H(HSD)
	TK165V65Z5 &	650	+/-30	18	0.165	30	1660	DTMOSVI(HSD)
	TK28V65W5 &	650	+/-30	27.6	0.14	90	3000	DTMOSIV(HSD)
	TK125V65Z	650	+/-30	24	0.125	40	2250	DTMOSVI
	TK28V65W	650	+/-30	27.6	0.12	75	3000	DTMOSIV
	TK115V65Z5 &	650	+/-30	23	0.115	42	2280	DTMOSVI(HSD)
	TK099V65Z	650	+/-30	30	0.099	47	2780	DTMOSVI
TK095V65Z5 &	650	+/-30	28	0.095	50	2880	DTMOSVI(HSD)	

☆ New Products, & High Speed Diode type

## D2PAK



Circuit Configuration	Part Number	Absolute Maximum Ratings			R <sub>DS(ON)</sub> max (Ω) V <sub>GS</sub> = 10 V	Q <sub>g</sub> typ. (nC)	C <sub>iss</sub> typ. (pF)	Remark
		V <sub>DSS</sub> (V)	V <sub>GSS</sub> (V)	I <sub>D</sub> (A)				
N-ch	TK16G60W5 &	600	+/-30	15.8	0.23	43	1350	DTMOSIV(HSD)
	TK16G60W	600	+/-30	15.8	0.19	38	1350	DTMOSIV
	TK20G60W	600	+/-30	20	0.155	48	1680	DTMOSIV
	TK14G65W5 &	650	+/-30	13.7	0.3	40	1300	DTMOSIV(HSD)
	TK14G65W	650	+/-30	13.7	0.25	35	1300	DTMOSIV

## TOLL



Circuit Configuration	Part Number	Absolute Maximum Ratings			R <sub>DS(ON)</sub> max (Ω) V <sub>GS</sub> = 10 V	Q <sub>g</sub> typ. (nC)	C <sub>iss</sub> typ. (pF)	Remark
		V <sub>DSS</sub> (V)	V <sub>GSS</sub> (V)	I <sub>D</sub> (A)				
N-ch	TK190U60Z1 ☆	600	+/-30	14	0.19	20	1060	DTMOSVI
	TK155U60Z1	600	+/-30	17	0.155	24	1350	DTMOSVI
	TK155U60Z5 ☆ &	600	+/-30	17	0.155	26	1410	DTMOSVI(HSD)
	TK125U60Z1	600	+/-30	20	0.125	28	1620	DTMOSVI
	TK125U60Z5 ☆ &	600	+/-30	20	0.125	30	1640	DTMOSVI(HSD)
	TK099U60Z1 ☆	600	+/-30	25	0.099	36	2050	DTMOSVI
	TK080U60Z1	600	+/-30	30	0.08	43	2510	DTMOSVI
	TK073U60Z5 ☆ &	600	+/-30	32	0.073	50	2860	DTMOSVI(HSD)
	TK055U60Z1	600	+/-30	40	0.055	65	3680	DTMOSVI
	TK055U60Z5 ☆ &	600	+/-30	40	0.055	66	3750	DTMOSVI(HSD)
	TK200U65Z5 ☆ &	650	+/-30	15	0.2	26	1400	DTMOSVI(HSD)
	TK190U65Z	650	+/-30	15	0.19	25	1370	DTMOSVI
	TK165U65Z5 ☆ &	650	+/-30	18	0.165	30	1660	DTMOSVI(HSD)
	TK155U65Z	650	+/-30	18	0.155	29	1635	DTMOSVI
	TK115U65Z5 ☆ &	650	+/-30	24	0.115	42	2280	DTMOSVI(HSD)
	TK110U65Z	650	+/-30	24	0.11	40	2250	DTMOSVI
	TK095U65Z5 ☆ &	650	+/-30	29	0.095	50	2880	DTMOSVI(HSD)
	TK090U65Z	650	+/-30	30	0.09	47	2780	DTMOSVI
	TK068U65Z5 ☆ &	650	+/-30	37	0.068	68	3765	DTMOSVI(HSD)
	TK065U65Z	650	+/-30	38	0.065	62	3650	DTMOSVI

☆ New Products, & High Speed Diode type



# TO-220

Circuit Configuration	Part Number	Absolute Maximum Ratings			R <sub>DS(ON)</sub> max (Ω)	Q <sub>g</sub> typ. (nC)	C <sub>iss</sub> typ. (pF)	Remark
		V <sub>BSS</sub> (V)	V <sub>GSS</sub> (V)	I <sub>B</sub> (A)	V <sub>GS</sub> = 10 V			
N-ch	TK10E60W	600	+/-30	9.7	0.38	20	700	DTMOSIV
	TK12E60W	600	+/-30	11.5	0.3	25	890	DTMOSIV
	TK16E60W5 &	600	+/-30	15.8	0.23	43	1350	DTMOSIV(HSD)
	TK190E60Z1 ☆	600	+/-30	14	0.19	20	1060	DTMOSVI
	TK16E60W	600	+/-30	15.8	0.19	38	1350	DTMOSIV
	TK20E60W5 &	600	+/-30	20	0.175	55	1800	DTMOSIV(HSD)
	TK155E60Z1	600	+/-30	17	0.155	24	1350	DTMOSVI
	TK155E60Z5 ☆ &	600	+/-30	17	0.155	26	1410	DTMOSVI(HSD)
	TK20E60W	600	+/-30	20	0.155	48	1680	DTMOSIV
	TK25E60X5 &	600	+/-30	25	0.14	60	2400	DTMOSIV-H(HSD)
	TK125E60Z1	600	+/-30	20	0.125	28	1620	DTMOSVI
	TK125E60Z5 ☆ &	600	+/-30	20	0.125	30	1640	DTMOSVI(HSD)
	TK25E60X	600	+/-30	25	0.125	40	2400	DTMOSIV-H
	TK099E60Z1 ☆	600	+/-30	25	0.099	36	2050	DTMOSVI
	TK31E60W	600	+/-30	30.8	0.088	86	3000	DTMOSIV
	TK31E60X	600	+/-30	30.8	0.088	65	3000	DTMOSIV-H
	TK080E60Z1 ☆	600	+/-30	30	0.08	43	2510	DTMOSVI
	TK073E60Z5 ☆ &	600	+/-30	32	0.073	50	2860	DTMOSVI(HSD)
	TK14E65W5 &	650	+/-30	13.7	0.3	40	1300	DTMOSIV(HSD)
	TK14E65W	650	+/-30	13.7	0.25	35	1300	DTMOSIV
	TK200E65Z5 &	650	+/-30	15	0.2	26	1400	DTMOSVI(HSD)
	TK17E65W	650	+/-30	17.3	0.2	45	1800	DTMOSIV
	TK190E65Z	650	+/-30	15	0.19	25	1370	DTMOSVI
	TK165E65Z5 &	650	+/-30	18	0.165	30	1660	DTMOSVI(HSD)
	TK155E65Z	650	+/-30	18	0.155	29	1635	DTMOSVI
	TK115E65Z5 &	650	+/-30	24	0.115	42	2280	DTMOSVI(HSD)
	TK110E65Z	650	+/-30	24	0.11	40	2250	DTMOSVI
	TK28E65W	650	+/-30	27.6	0.11	75	3000	DTMOSIV
	TK095E65Z5 &	650	+/-30	29	0.095	50	2880	DTMOSVI(HSD)
	TK090E65Z	650	+/-30	30	0.09	47	2780	DTMOSVI
TK7E80W	800	+/-20	6.5	0.95	13	700	DTMOSIV	
TK10E80W	800	+/-20	9.5	0.55	19	1150	DTMOSIV	
TK12E80W	800	+/-20	11.5	0.45	23	1400	DTMOSIV	
TK17E80W	800	+/-20	17	0.29	32	2050	DTMOSIV	

☆ New Products, & High Speed Diode type

# TO-220SIS



Circuit Configuration	Part Number	Absolute Maximum Ratings			R <sub>DS(ON)</sub> max (Ω)	Q <sub>g</sub> typ. (nC)	C <sub>iss</sub> typ. (pF)	Remark
		V <sub>DSS</sub> (V)	V <sub>CESS</sub> (V)	I <sub>D</sub> (A)	V <sub>GS</sub> = 10 V			
N-ch	TK10A50W	500	+/-30	9.7	0.38	20	700	DTMOSIV
	TK12A50W	500	+/-30	11.5	0.3	25	890	DTMOSIV
	TK19A50W	500	+/-30	18.5	0.19	38	1350	DTMOSIV
	TK6A60W	600	+/-30	6.2	0.75	12	390	DTMOSIV
	TK7A60W5 &	600	+/-30	7	0.65	16	490	DTMOSIV(HSD)
	TK7A60W	600	+/-30	7	0.6	15	490	DTMOSIV
	TK560A60Y	600	+/-30	7	0.56	14.5	380	DTMOSV
	TK8A60W5 &	600	+/-30	8	0.54	22	590	DTMOSIV(HSD)
	TK8A60W	600	+/-30	8	0.5	18.5	570	DTMOSIV
	TK10A60W5 &	600	+/-30	9.7	0.45	25	720	DTMOSIV(HSD)
	TK10A60W	600	+/-30	9.7	0.38	20	700	DTMOSIV
	TK380A60Y	600	+/-30	9.7	0.38	20	590	DTMOSV
	TK12A60W	600	+/-30	11.5	0.3	25	890	DTMOSIV
	TK290A60Y	600	+/-30	11.5	0.29	25	730	DTMOSV
	TK16A60W5 &	600	+/-30	15.8	0.23	43	1350	DTMOSIV(HSD)
	TK16A60W	600	+/-30	15.8	0.19	38	1350	DTMOSIV
	TK190A60Z1 ☆	600	+/-30	14	0.19	20	1060	DTMOSVI
	TK20A60W5 &	600	+/-30	20	0.175	55	1800	DTMOSIV(HSD)
	TK155A60Z1	600	+/-30	17	0.155	24	1350	DTMOSVI
	TK155A60Z5 ☆ &	600	+/-30	17	0.155	26	1410	DTMOSVI(HSD)
	TK20A60W	600	+/-30	20	0.155	48	1680	DTMOSIV
	TK25A60X5 &	600	+/-30	25	0.14	60	2400	DTMOSIV-H(HSD)
	TK125A60Z1	600	+/-30	20	0.125	28	1620	DTMOSVI
	TK125A60Z5 ☆ &	600	+/-30	20	0.125	30	1640	DTMOSVI(HSD)
	TK25A60X	600	+/-30	25	0.125	40	2400	DTMOSIV-H
	TK099A60Z1 ☆	600	+/-30	25	0.099	36	2050	DTMOSVI
	TK31A60W	600	+/-30	30.8	0.088	86	3000	DTMOSIV
	TK080A60Z1	600	+/-30	30	0.08	43	2510	DTMOSVI
	TK073A60Z5 ☆ &	600	+/-30	32	0.073	50	2860	DTMOSVI(HSD)
	TK39A60W	600	+/-30	38.8	0.065	110	4100	DTMOSIV
	TK6A65W	650	+/-30	5.8	1	11	390	DTMOSIV
	TK7A65W	650	+/-30	6.8	0.78	15	490	DTMOSIV
	TK8A65W	650	+/-30	7.8	0.65	16	570	DTMOSIV
	TK560A65Y	650	+/-30	7	0.56	14.5	380	DTMOSV
	TK9A65W	650	+/-30	9.3	0.5	20	700	DTMOSIV
	TK11A65W	650	+/-30	11.1	0.39	25	890	DTMOSIV
	TK380A65Y	650	+/-30	9.7	0.38	20	590	DTMOSV
	TK14A65W5 &	650	+/-30	13.7	0.3	40	1300	DTMOSIV(HSD)
	TK290A65Y	650	+/-30	11.5	0.29	25	730	DTMOSV
	TK14A65W	650	+/-30	13.7	0.25	35	1300	DTMOSIV
	TK17A65W5 &	650	+/-30	17.3	0.23	50	1800	DTMOSIV(HSD)
	TK17A65W	650	+/-30	17.3	0.2	45	1800	DTMOSIV
	TK200A65Z5 &	650	+/-30	15	0.2	26	1400	DTMOSVI(HSD)
	TK190A65Z	650	+/-30	15	0.19	25	1370	DTMOSVI
	TK165A65Z5 &	650	+/-30	18	0.165	30	1660	DTMOSVI(HSD)
	TK22A65X5 &	650	+/-30	22	0.16	50	2400	DTMOSIV-H(HSD)
	TK155A65Z	650	+/-30	18	0.155	29	1635	DTMOSVI
	TK22A65X	650	+/-30	22	0.15	50	2400	DTMOSIV-H
TK115A65Z5 &	650	+/-30	24	0.115	42	2280	DTMOSVI(HSD)	
TK110A65Z	650	+/-30	24	0.11	40	2250	DTMOSVI	
TK28A65W	650	+/-30	27.6	0.11	75	3000	DTMOSIV	

☆ New Products, & High Speed Diode type



## TO-220SIS

Circuit Configuration	Part Number	Absolute Maximum Ratings			R <sub>DS(ON)</sub> max (Ω)	Q <sub>g</sub> typ. (nC)	C <sub>iss</sub> typ. (pF)	Remark
		V <sub>DSS</sub> (V)	V <sub>GSS</sub> (V)	I <sub>D</sub> (A)	V <sub>GS</sub> = 10 V			
N-ch	TK095A65Z5 &	650	+/-30	29	0.095	50	2880	DTMOSV(HSD)
	TK35A65W5 &	650	+/-30	35	0.095	115	4100	DTMOSIV(HSD)
	TK090A65Z	650	+/-30	30	0.09	47	2780	DTMOSVI
	TK35A65W	650	+/-30	35	0.08	100	4100	DTMOSIV
	TK7A80W	800	+/-20	6.5	0.95	13	700	DTMOSIV
	TK10A80W	800	+/-20	9.5	0.55	19	1150	DTMOSIV
	TK12A80W	800	+/-20	11.5	0.45	23	1400	DTMOSIV
TK17A80W	800	+/-20	17	0.29	32	2050	DTMOSIV	

& High Speed Diode type



## TO-3P(N)

Circuit Configuration	Part Number	Absolute Maximum Ratings			$R_{DS(ON)}$ max ( $\Omega$ )	$Q_g$ typ. (nC)	$C_{iss}$ typ. (pF)	Remark
		$V_{DSS}$ (V)	$V_{GSS}$ (V)	$I_D$ (A)	$V_{GS} = 10$ V			
N-ch	TK12J60W	600	+/-30	11.5	0.3	25	890	DTMOSIV
	TK16J60W	600	+/-30	15.8	0.19	38	1350	DTMOSIV
	TK20J60W	600	+/-30	20	0.155	48	1680	DTMOSIV
	TK31J60W	600	+/-30	30.8	0.088	86	3000	DTMOSIV
	TK39J60W	600	+/-30	38.8	0.065	110	4100	DTMOSIV

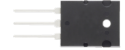

## TO-3P(L)

Circuit Configuration	Part Number	Absolute Maximum Ratings			$R_{DS(ON)}$ max ( $\Omega$ )	$Q_g$ typ. (nC)	$C_{iss}$ typ. (pF)	Remark
		$V_{DSS}$ (V)	$V_{GSS}$ (V)	$I_D$ (A)	$V_{GS} = 10$ V			
N-ch	TK100L60W	600	+/-30	100	0.018	360	15000	DTMOSIV



TO-247

Circuit Configuration	Part Number	Absolute Maximum Ratings			R <sub>DS(ON)</sub> max (Ω)		Q <sub>s</sub> typ. (nC)	C <sub>iss</sub> typ. (pF)	Remark
		V <sub>SS</sub> (V)	V <sub>GS</sub> (V)	I <sub>D</sub> (A)	V <sub>GS</sub> = 10 V				
N-ch	TK16N60W5 &	600	+/-30	15.8	0.23		43	1350	DTMOSIV(HSD)
	TK16N60W	600	+/-30	15.8	0.19		38	1350	DTMOSIV
	TK20N60W5 &	600	+/-30	20	0.175		55	1800	DTMOSIV(HSD)
	TK20N60W	600	+/-30	20	0.155		48	1680	DTMOSIV
	TK25N60X5 &	600	+/-30	25	0.14		60	2400	DTMOSIV-H(HSD)
	TK125N60Z1	600	+/-30	20	0.125		28	1620	DTMOSVI
	TK25N60X	600	+/-30	25	0.125		40	2400	DTMOSIV-H
	TK099N60Z1 ☆	600	+/-30	25	0.099		36	2050	DTMOSVI
	TK31N60W5 &	600	+/-30	30.8	0.099		105	3000	DTMOSIV(HSD)
	TK31N60W	600	+/-30	30.8	0.088		86	3000	DTMOSIV
	TK31N60X	600	+/-30	30.8	0.088		65	3000	DTMOSIV-H
	TK080N60Z1	600	+/-30	30	0.08		43	2510	DTMOSVI
	TK39N60W5 &	600	+/-30	38.8	0.074		135	4100	DTMOSIV(HSD)
	TK073N60Z5 ☆&	600	+/-30	32	0.073		50	2860	DTMOSVI(HSD)
	TK39N60W	600	+/-30	38.8	0.065		110	4100	DTMOSIV
	TK39N60X	600	+/-30	38.8	0.065		85	4100	DTMOSIV-H
	TK063N60Z1 ☆	600	+/-30	37	0.063		56	3200	DTMOSVI
	TK055N60Z5 ☆&	600	+/-30	40	0.055		66	3750	DTMOSVI(HSD)
	TK62N60W5 &	600	+/-30	61.8	0.045		205	6500	DTMOSIV(HSD)
	TK040N60Z1	600	+/-30	52	0.04		85	5200	DTMOSVI
	TK040N60Z5 ☆&	600	+/-30	51	0.04		93	5340	DTMOSVI(HSD)
	TK62N60W	600	+/-30	61.8	0.04		180	6500	DTMOSIV
	TK62N60X	600	+/-30	61.8	0.04		135	6500	DTMOSIV-H
	TK034N60Z5 ☆&	600	+/-30	60	0.034		105	6200	DTMOSVI(HSD)
	TK024N60Z1 ☆	600	+/-30	80	0.024		140	8420	DTMOSVI
	TK14N65W5 &	650	+/-30	13.7	0.3		40	1300	DTMOSIV(HSD)
	TK14N65W	650	+/-30	13.7	0.25		35	1300	DTMOSIV
	TK17N65W	650	+/-30	17.3	0.2		45	1800	DTMOSIV
	TK28N65W5 &	650	+/-30	27.6	0.13		90	3000	DTMOSIV(HSD)
	TK115N65Z5 &	650	+/-30	24	0.115		42	2280	DTMOSVI(HSD)
	TK110N65Z	650	+/-30	24	0.11		40	2250	DTMOSVI
	TK28N65W	650	+/-30	27.6	0.11		75	3000	DTMOSIV
	TK095N65Z5 &	650	+/-30	29	0.095		50	2880	DTMOSVI(HSD)
	TK35N65W5 &	650	+/-30	35	0.095		115	4100	DTMOSIV(HSD)
	TK090N65Z	650	+/-30	30	0.09		47	2780	DTMOSVI
	TK35N65W	650	+/-30	35	0.08		100	4100	DTMOSIV
	TK068N65Z5 &	650	+/-30	37	0.068		68	3765	DTMOSVI(HSD)
	TK065N65Z	650	+/-30	38	0.065		62	3650	DTMOSVI
	TK49N65W5 &	650	+/-30	49.2	0.057		185	6500	DTMOSIV(HSD)
	TK49N65W	650	+/-30	49.2	0.055		160	6500	DTMOSIV
TK042N65Z5 &	650	+/-30	55	0.042		105	6280	DTMOSVI(HSD)	
TK040N65Z	650	+/-30	57	0.04		105	6250	DTMOSVI	

☆ New Products, & High Speed Diode type

## TO-247-4L



Circuit Configuration	Part Number	Absolute Maximum Ratings			R <sub>DS(ON)</sub> max (Ω)		Q <sub>g</sub> typ. (nC)	C <sub>iss</sub> typ. (pF)	Remark
		V <sub>DSS</sub> (V)	V <sub>GSS</sub> (V)	I <sub>D</sub> (A)	V <sub>GS</sub> = 10 V				
N-ch	TK25Z60X	600	+/-30	25	0.125		40	2400	DTMOSIV-H
	TK31Z60X	600	+/-30	30.8	0.088		65	3000	DTMOSIV-H
	TK39Z60X	600	+/-30	38.8	0.065		85	4100	DTMOSIV-H
	TK62Z60X	600	+/-30	61.8	0.04		135	6500	DTMOSIV-H
	TK110Z65Z	650	+/-30	24	0.11		40	2250	DTMOSVI
	TK090Z65Z	650	+/-30	30	0.09		47	2780	DTMOSVI
	TK065Z65Z	650	+/-30	38	0.065		62	3650	DTMOSVI
	TK040Z65Z	650	+/-30	57	0.04		105	6250	DTMOSVI

## TO-247-4L(X)



Circuit Configuration	Part Number	Absolute Maximum Ratings			R <sub>DS(ON)</sub> max (Ω)		Q <sub>g</sub> typ. (nC)	C <sub>iss</sub> typ. (pF)	Remark
		V <sub>DSS</sub> (V)	V <sub>GSS</sub> (V)	I <sub>D</sub> (A)	V <sub>GS</sub> = 10 V				
N-ch	TK125Z60Z1 ☆	600	+/-30	20	0.125		28	1620	DTMOSVI
	TK099Z60Z1 ☆	600	+/-30	25	0.099		36	2050	DTMOSVI
	TK080Z60Z1 ☆	600	+/-30	30	0.08		43	2510	DTMOSVI
	TK(073)Z60Z5 ★ &	600	+/-30	(32)	(0.073)		(50)	(2860)	DTMOSVI(HSD)
	TK063Z60Z1 ☆	600	+/-30	37	0.063		56	3200	DTMOSVI
	TK(055)Z60Z5 ★ &	600	+/-30	(40)	(0.055)		(66)	(3750)	DTMOSVI(HSD)
	TK040Z60Z1 ☆	600	+/-30	52	0.04		85	5200	DTMOSVI
	TK(040)Z60Z5 ★ &	600	+/-30	(51)	(0.04)		(93)	(5340)	DTMOSVI(HSD)
	TK(034)Z60Z5 ★ &	600	+/-30	(60)	(0.034)		(105)	(6200)	DTMOSVI(HSD)
	TK024Z60Z1 ☆	600	+/-30	80	0.024		140	8420	DTMOSVI
	TK115Z65Z5 ☆ &	650	+/-30	24	0.115		42	2280	DTMOSVI(HSD)
	TK095Z65Z5 ☆ &	650	+/-30	29	0.095		50	2880	DTMOSVI(HSD)
	TK068Z65Z5 ☆ &	650	+/-30	37	0.068		68	3765	DTMOSVI(HSD)
TK042Z65Z5 ☆ &	650	+/-30	55	0.042		105	6280	DTMOSVI(HSD)	

☆ New Products, & High Speed Diode type

★ Under Development (The specification is subject to change without notice.)

### 3. Automotive MOSFET Series



#### DPAK+

Circuit Configuration	Part Number	Absolute Maximum Ratings			R <sub>DS(ON)</sub> max (mΩ)			Q <sub>g</sub> typ. (nC)	C <sub>iss</sub> typ. (pF)	Remark
		V <sub>oss</sub> (V)	V <sub>ess</sub> (V)	I <sub>D</sub> (A)	V <sub>GS</sub>   = 10 V	V <sub>GS</sub>   = 6 V	V <sub>GS</sub>   = 4.5 V			
N-ch	TK15S04N1L # # \$	40	+/-20	15	17.8	-	37	10	610	U-MOSVIII-H
	TK65S04N1L # # \$	40	+/-20	65	4.3	-	7.8	39	2550	U-MOSVIII-H
	TK100S04N1L #	40	+/-20	100	2.3	-	4.5	76	5490	U-MOSVIII-H
	TK1R4S04PB #	40	+/-20	120	1.35	1.9	-	103	5500	U-MOSIX-H
	TK25S06N1L # # \$	60	+/-20	25	18.5	-	36.8	15	855	U-MOSVIII-H
	TK40S06N1L # # \$	60	+/-20	40	10.5	-	18	26	1650	U-MOSVIII-H
	TK90S06N1L #	60	+/-20	90	3.3	-	5.2	81	5400	U-MOSVIII-H
	TK7510N1Z # # \$	100	+/-20	7	48	-	-	7.1	470	U-MOSVIII-H
	TK11S10N1L # # \$	100	+/-20	11	28	-	50	15	850	U-MOSVIII-H
	TK33S10N1L # # \$	100	+/-20	33	9.7	-	16.2	33	2250	U-MOSVIII-H
	TK33S10N1Z # # \$	100	+/-20	33	9.7	-	-	28	2050	U-MOSVIII-H
	TK55S10N1 #	100	+/-20	55	6.5	-	-	49	3280	U-MOSVIII-H
TK60S10N1L #	100	+/-20	60	6.11	9.25	-	60	4320	U-MOSVIII-H	
P-ch	TJ10S04M3L # # \$	-40	+10/-20	-10	44	62	-	19	930	U-MOSVI
	TJ20S04M3L # # \$	-40	+10/-20	-20	22.2	32	-	37	1850	U-MOSVI
	TJ40S04M3L # # \$	-40	+10/-20	-40	9.1	13	-	83	4140	U-MOSVI
	TJ60S04M3L # # \$	-40	+10/-20	-60	6.3	9.4	-	125	6510	U-MOSVI
	TJ80S04M3L # # \$	-40	+10/-20	-80	5.2	7.9	-	158	7770	U-MOSVI
	TJ90S04M3L # # \$	-40	+10/-20	-90	4.3	-	6	172	7700	U-MOSVI
	TJ8S06M3L # # \$	-60	+10/-20	-8	104	130	-	19	890	U-MOSVI
	TJ15S06M3L # # \$	-60	+10/-20	-15	50	63	-	36	1770	U-MOSVI
	TJ30S06M3L # # \$	-60	+10/-20	-30	21.8	28	-	80	3950	U-MOSVI
	TJ50S06M3L # # \$	-60	+10/-20	-50	13.8	17.4	-	124	6290	U-MOSVI
	TJ60S06M3L # # \$	-60	+10/-20	-60	11.2	14.5	-	156	7760	U-MOSVI

#### TSON Advance(WF) (3.1 x 3.6)

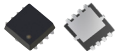

Circuit Configuration	Part Number	Absolute Maximum Ratings			R <sub>DS(ON)</sub> max (mΩ)		Q <sub>g</sub> typ. (nC)	C <sub>iss</sub> typ. (pF)	Remark
		V <sub>oss</sub> (V)	V <sub>ess</sub> (V)	I <sub>D</sub> (A)	V <sub>GS</sub>   = 10 V	V <sub>GS</sub>   = 4.5 V			
N-ch	XPN7R104NC ◆ # \$	40	+/-20	20	7.1	14.2	21	1290	U-MOSVIII-H
	XPN3R804NC ◆ # \$	40	+/-20	40	3.8	7.8	35	2230	U-MOSVIII-H
	XPN12006NC ◆ # \$	60	+/-20	20	12	23.7	23	1100	U-MOSVIII-H
	XPN6R706NC ◆ # \$	60	+/-20	40	6.7	13.3	35	2000	U-MOSVIII-H
	XPN1300ANC ◆ # \$	100	+/-20	30	13.3	24.2	28	1470	U-MOSVIII-H
P-ch	XPN19014MC ◆ # \$	-40	+10/-20	-20	18.7	29.2	51	1600	U-MOSVI
	XPN9R614MC ◆ #	-40	+10/-20	-40	9.6	13.4	64	3000	U-MOSVI
	XPN52016MC ◆ # \$	-60	+10/-20	-15	52	66	47	1680	U-MOSVI
	XPN27016MC ◆ #	-60	+10/-20	-25	27.3	36	71	2900	U-MOSVI

# AEC-Q101 qualified, \$ With protection Zener diode between gate and source, ◆ Wetable Flank Lead Terminal

## SOP Advance(WF) ( 5 x 6 )



Circuit Configuration	Part Number	Absolute Maximum Ratings			R <sub>DS(ON)</sub> max (mΩ)			Q <sub>g</sub> typ. (nC)	C <sub>iss</sub> typ. (pF)	Remark
		V <sub>DSS</sub> (V)	V <sub>GSS</sub> (V)	I <sub>D</sub> (A)	V <sub>GS</sub>   = 10 V	V <sub>GS</sub>   = 6 V	V <sub>GS</sub>   = 4.5 V			
N-ch	XPH3R304PS ◆ #	40	+20/-8	60	3.3	6.3	-	30	1660	U-MOSIX-H
	XPH2R404PS ◆ #	40	+20/-8	90	2.4	4.1	-	40	2500	U-MOSIX-H
	XPH1R104PS ◆ #	40	+/-20	120	1.14	1.96	-	55	4560	U-MOSIX-H
	XPHR9904PS ◆ #	40	+/-20	130	0.99	1.63	-	83	5520	U-MOSIX-H
	XPHR7904PS ◆ #	40	+/-20	150	0.79	1.3	-	85	6650	U-MOSIX-H
	XPH3R206NC ◆ # \$	60	+/-20	70	3.2	-	6.2	65	4180	U-MOSVIII-H
	XPH2R106NC ◆ #	60	+/-20	110	2.1	-	4.1	104	6900	U-MOSVIII-H
	XPH3R908QB ☆ ◆ #	80	+/-20	80	3.9	5.7	-	63	3900	U-MOSX-H
	XPH2R608QB ☆ ◆ #	80	+/-20	120	2.55	3.64	-	95	6200	U-MOSX-H
	XPH6R30ANB ◆ # \$	100	+/-20	45	6.3	9.5	-	52	3240	U-MOSVIII-H
XPH4R10ANB ◆ #	100	+/-20	70	4.1	6.2	-	75	4970	U-MOSVIII-H	
P-ch	XPH4R714MC ◆ #	-40	+10/-20	-60	4.7	-	6.9	140	5640	U-MOSVI
	XPH3R114MC ◆ #	-40	+10/-20	-100	3.1	-	4.7	230	9500	U-MOSVI
	XPH13016MC ◆ #	-60	+10/-20	-60	12.9	-	16.6	148	6820	U-MOSVI
	XPH8R316MC ◆ #	-60	+10/-20	-90	8.3	-	10.2	222	10500	U-MOSVI

## SOP Advance(EWF) ( 4.9 x 6.47 )

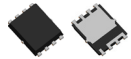

Circuit Configuration	Part Number	Absolute Maximum Ratings			R <sub>DS(ON)</sub> max (mΩ)		Q <sub>g</sub> typ. (nC)	C <sub>iss</sub> typ. (pF)	Remark
		V <sub>DSS</sub> (V)	V <sub>GSS</sub> (V)	I <sub>D</sub> (A)	V <sub>GS</sub>   = 10 V	V <sub>GS</sub>   = 6 V			
N-ch	XPMR8504PB ☆ ◆ #	40	+/-20	140	0.85	1.52	90	6350	U-MOSIX-H
	XPMR7404PB ☆ ◆ #	40	+/-20	160	0.74	1.28	107	7550	U-MOSIX-H
	XPMR5904PB ☆ ◆ #	40	+/-20	180	0.59	1.05	127	9240	U-MOSIX-H

## DSOP Advance(WF) ( 5 x 6 )



Circuit Configuration	Part Number	Absolute Maximum Ratings			R <sub>DS(ON)</sub> max (mΩ)		Q <sub>g</sub> typ. (nC)	C <sub>iss</sub> typ. (pF)	Remark
		V <sub>DSS</sub> (V)	V <sub>GSS</sub> (V)	I <sub>D</sub> (A)	V <sub>GS</sub>   = 10 V	V <sub>GS</sub>   = 6 V			
N-ch	TPW1R104PB * ◆ #	40	+/-20	120	1.14	1.96	55	4560	U-MOSIX-H
	TPWR7904PB ** ◆ #	40	+/-20	150	0.79	1.3	85	6650	U-MOSIX-H
	XPW6R30ANB * ◆ # \$	100	+/-20	45	6.3	9.5	52	3240	U-MOSVIII-H
	XPW4R10ANB ** ◆ #	100	+/-20	70	4.1	6.2	75	4970	U-MOSVIII-H

# AEC-Q101 qualified, \$ With protection Zener diode between gate and source, ◆ Wettable Flank Lead Terminal

\* DSOP Advance(WF)M, \*\* DSOP Advance(WF)L

☆ New Products



## S-TOGL™ ( 7 x 8.44 )

Circuit Configuration	Part Number		Absolute Maximum Ratings			R <sub>DS(ON)</sub> max (mΩ)		Q <sub>g</sub> typ. (nC)	C <sub>iss</sub> typ. (pF)	Remark
			V <sub>DSS</sub> (V)	V <sub>GSS</sub> (V)	I <sub>D</sub> (A)	V <sub>GS</sub>   = 10 V	V <sub>GS</sub>   = 6 V			
N-ch	XPJ1R504PB	☆ # %	40	+/-20	100	1.54	2.67	61	4100	U-MOSIX-H
	XPJ1R004PB	# %	40	+/-20	160	1	1.8	84	5300	U-MOSIX-H
	XPJR6604PB	# %	40	+/-20	200	0.66	1.16	128	8750	U-MOSIX-H



## L-TOGL™ ( 9.9 x 11.81 )

Circuit Configuration	Part Number		Absolute Maximum Ratings			R <sub>DS(ON)</sub> max (mΩ)		Q <sub>g</sub> typ. (nC)	C <sub>iss</sub> typ. (pF)	Remark
			V <sub>DSS</sub> (V)	V <sub>GSS</sub> (V)	I <sub>D</sub> (A)	V <sub>GS</sub>   = 10 V	V <sub>GS</sub>   = 6 V			
N-ch	XPQ1R004PB	# %	40	+/-20	200	1	1.8	84	5300	U-MOSIX-H
	XPQR3004PB	# %	40	+/-20	400	0.30	0.47	295	20700	U-MOSIX-H
	XPQR8308QB	# %	80	+/-20	350	0.83	1.23	305	19000	U-MOSX-H
	XPQ1R00AQB	# %	100	+/-20	300	1.03	1.93	269	16500	U-MOSX-H

# AEC-Q101 qualified,  
% V<sub>th</sub> pairing is possible.  
☆ New Products

## 4. Silicon Carbide (SiC) MOSFET Series



### TO-247

Circuit Configuration	Part Number	Absolute Maximum Ratings			R <sub>DS(ON)</sub> typ. (Ω)	Q <sub>g</sub> typ. (nC)	C <sub>iss</sub> typ. (pF)	Remark
		V <sub>DSS</sub> (V)	V <sub>GSS</sub> (V)	I <sub>D</sub> (A)	V <sub>GS</sub> = 18 V			
N-ch	TW107N65C	650	+25/-10	20	0.107	21	600	3rd generation
	TW083N65C	650	+25/-10	30	0.083	28	873	3rd generation
	TW048N65C	650	+25/-10	40	0.048	41	1362	3rd generation
	TW027N65C	650	+25/-10	58	0.027	65	2288	3rd generation
	TW015N65C	650	+25/-10	100	0.015	128	4850	3rd generation
	TW140N120C	1200	+25/-10	20	0.14	24	691	3rd generation
	TW060N120C	1200	+25/-10	36	0.06	46	1530	3rd generation
	TW045N120C	1200	+25/-10	40	0.045	57	1969	3rd generation
	TW030N120C	1200	+25/-10	60	0.03	82	2925	3rd generation
TW015N120C	1200	+25/-10	100	0.015	158	6000	3rd generation	



### TO-247-4L(X)

Circuit Configuration	Part Number	Absolute Maximum Ratings			R <sub>DS(ON)</sub> typ. (Ω)	Q <sub>g</sub> typ. (nC)	C <sub>iss</sub> typ. (pF)	Remark
		V <sub>DSS</sub> (V)	V <sub>GSS</sub> (V)	I <sub>D</sub> (A)	V <sub>GS</sub> = 18 V			
N-ch	TW107Z65C	650	+25/-10	20	0.107	21	600	3rd generation
	TW083Z65C	650	+25/-10	30	0.083	28	873	3rd generation
	TW048Z65C	650	+25/-10	40	0.048	41	1362	3rd generation
	TW027Z65C	650	+25/-10	58	0.027	65	2288	3rd generation
	TW015Z65C	650	+25/-10	100	0.015	128	4850	3rd generation
	TW140Z120C	1200	+25/-10	20	0.14	24	691	3rd generation
	TW060Z120C	1200	+25/-10	36	0.06	46	1530	3rd generation
	TW045Z120C	1200	+25/-10	40	0.045	57	1969	3rd generation
	TW030Z120C	1200	+25/-10	60	0.03	82	2925	3rd generation
TW015Z120C	1200	+25/-10	100	0.015	158	6000	3rd generation	

### TOLL



Circuit Configuration	Part Number	Absolute Maximum Ratings			R <sub>DS(ON)</sub> typ. (Ω)	Q <sub>g</sub> typ. (nC)	C <sub>iss</sub> typ. (pF)	Remark
		V <sub>DSS</sub> (V)	V <sub>GSS</sub> (V)	I <sub>D</sub> (A)	V <sub>GS</sub> = 18 V			
N-ch	TW083U65C ☆	650	+25/-10	28	0.083	28	873	3rd generation
	TW048U65C ☆	650	+25/-10	39	0.048	41	1362	3rd generation
	TW027U65C ☆	650	+25/-10	57	0.027	65	2288	3rd generation

### DFN8x8



Circuit Configuration	Part Number	Absolute Maximum Ratings			R <sub>DS(ON)</sub> typ. (Ω)	Q <sub>g</sub> typ. (nC)	C <sub>iss</sub> typ. (pF)	Remark
		V <sub>DSS</sub> (V)	V <sub>GSS</sub> (V)	I <sub>D</sub> (A)	V <sub>GS</sub> = 18 V			
N-ch	TW123V65C ☆	650	+25/-10	18	0.123	21	600	3rd generation
	TW092V65C ☆	650	+25/-10	27	0.092	28	873	3rd generation
	TW054V65C ☆	650	+25/-10	36	0.054	41	1362	3rd generation
	TW031V65C ☆	650	+25/-10	53	0.031	65	2288	3rd generation

☆ New Products

## 5. Part Naming Conventions

### Conventional Multi-Pin Series

Ex.) TPC8 0 67 -H  
 ① ② ③ ④

- Package  
 TPC8: SOP-8 Series  
 TPC8: TSON Advance Series    TPC8: SOP Advance Series
- Polarity / Configuration  
 0: N-channel, single    3: P-channel, dual  
 1: P-channel, single    4: N-channel and P-channel, dual  
 2: N-channel, dual    J: P-channel and NPN
- Serial number of the products
- Additional information  
 H: High-speed type    None: Low-on-resistance type

### New Multi-Pin Series

Ex.) TPH 4R6 0 6 N H  
 ① ② ③ ④ ⑤ ⑥

- Package  
 TPH / XPH / TPM / XPM: SOP Advance Series    TP8: SOP-8 Series  
 TPN / XPN: TSON Advance Series    XPQ: L-TOGL™ Series  
 TPW / XPW: DSOP Advance Series    XPJ: S-TOGL™ Series
- Max. on-resistance (at max drive conditions)  
 R46 = 0.46 mΩ    100 = 10 × 10<sup>0</sup> = 100 mΩ  
 4R6 = 4.6 mΩ    101 = 10 × 10<sup>1</sup> = 1000 mΩ
- Polarity / Configuration  
 0: Single N-channel    1: Single P-channel
- Drain-source voltage (V<sub>DSS</sub>)  
 2: 15 to 24 V    7: 65 to 74 V    D: 180 to 199 V  
 3: 25 to 34 V    8: 75 to 84 V    E: 200 to 249 V  
 4: 35 to 44 V    A: 95 to 124 V    F: 250 to 299 V  
 5: 45 to 54 V    B: 125 to 149 V  
 6: 55 to 64 V    C: 150 to 179 V
- Series  
 M: U-MOSVI    N: U-MOSVII / U-MOSVIII-H    P: U-MOSIX-H  
 Q: U-MOSX-H    R: U-MOS11-H
- Additional information (1)  
 1 to 4: Serial number of the products  
 5: Fast body diode type  
 A: V<sub>GS</sub> = 10 V (Drive)  
 B: V<sub>GS</sub> = 6 V (Drive)  
 C: V<sub>GS</sub> = 4.5 V (Drive)  
 D: V<sub>GS</sub> = 2.5 V (Drive)  
 E: V<sub>GS</sub> = 2.0 V (Drive)  
 F: V<sub>GS</sub> = 1.8 V (Drive)  
 H: Low-rg, V<sub>GS</sub> = 10 V (Drive)  
 M: Low-rg, V<sub>GS</sub> = 6 V (Drive)  
 L: Low-rg, V<sub>GS</sub> = 4.5 V (Drive)  
 Q: T<sub>ch(max)</sub> = Guaranteed up to 175 °C + Zener diode  
 R: T<sub>ch(max)</sub> = Guaranteed up to 150 °C + Zener diode  
 S: T<sub>ch(max)</sub> = Guaranteed up to 175 °C  
 T: T<sub>ch(max)</sub> = Guaranteed up to 150 °C  
 U: Low spike

### Silicon carbide (SiC) Series

Ex.) TW 107 N 65 C  
 ① ② ③ ④ ⑤

- Polarity  
 TW: N-channel
- Typ. on-resistance (at max drive conditions)  
 070 = 70 mΩ
- Package  
 A: TO-220SIS    N: TO-247    Z: TO-247-4L(X)  
 E: TO-220    U: TOLL  
 J: TO-3P(N)    V: DFN8x8
- Drain-source voltage V<sub>DSS</sub>: Display value x 10 times = V<sub>DSS</sub>  
 120: V<sub>DSS</sub> = 1200 V
- Generation  
 C: 3rd Generation

### 3-Pin and Multi Pin Series

Ex.) TK 40 S 10 K 3 Z  
 ① ② ③ ④ ⑤ ⑥ ⑦

- Polarity  
 TK: N-channel    TJ: P-channel
- Drain current (I<sub>D</sub>)
- Package  
 A: TO-220SIS    N: TO-247  
 E: TO-220    P: DPAK / New PW-Mold  
 G: D2PAK    S: DPAK+  
 J: TO-3P(N)    V: DFN8x8  
 L: TO-3P(L)    Z: TO-247-4L
- Drain-source voltage (V<sub>DSS</sub>): Display value x 10 = V<sub>DSS</sub>  
 06: V<sub>DSS</sub> = 60 V    10: V<sub>DSS</sub> = 100 V
- Series  
 A: π-MOSIV    K: U-MOSIV    W: DTMOSIV  
 C: π-MOSVI    M: U-MOSVI    X: DTMOSIV-H  
 D: π-MOSVII    N: U-MOSVII    Z / Z1 / Z5: DTMOSVI  
 E: π-MOSVIII    U: DTMOS II  
 J: U-MOS III    V: DTMOS III
- Additional information (1)  
 1: Low-capacitance type    5: Fast body diode type  
 3: Low-on-resistance type
- Additional information (2)  
 L: V<sub>GS</sub> = 4.5 V (Drive)    S: V<sub>GS</sub> = 4.5 V (Drive)  
 H: V<sub>GS</sub> = 10 V (Drive)    Z: With protection Zener diode  
 M: V<sub>GS</sub> = 6 V (Drive)    between gate and source

### New 3-Pin and Multi Pin Series

Ex.) TK 1R4 S 04 P B  
 ① ② ③ ④ ⑤ ⑥

- Polarity  
 TK / XK: N-channel    TJ / XJ: P-channel
- Products with a maximum on-resistance V<sub>DSS</sub> of less than 400 V (at max drive conditions)  
 R74 = 0.74 mΩ    100 = 10 × 10<sup>0</sup> = 100 mΩ  
 8R2 = 8.2 mΩ    101 = 10 × 10<sup>1</sup> = 1000 mΩ  
 Products with a maximum on-resistance V<sub>DSS</sub> of 400 V or higher (at max drive conditions)  
 047 = 0.047 Ω    410 = 0.41 Ω    4K7 = 4.7 Ω
- Package  
 A: TO-220SIS    P: DPAK / New PW-Mold  
 E: TO-220    Q: IPAK / New PW-Mold2  
 G: D2PAK    S: DPAK+  
 J: TO-3P(N)    U: TOLL  
 L: TO-3P(L)    V: DFN8x8  
 N: TO-247    Z: TO-247-4L / TO-247-4L(X)
- Drain-source voltage V<sub>DSS</sub>: Display value x 10 times = V<sub>DSS</sub>  
 04: V<sub>DSS</sub> = 40 V    10: V<sub>DSS</sub> = 100 V
- Series  
 F: π-MOSIX    N: U-MOSVIII-H    Q: U-MOSX-H    Z: DTMOSVI  
 M: U-MOSVI    P: U-MOSIX-H    Y: DTMOS V
- Additional information  
 A: V<sub>GS</sub> = 10 V (Drive)    H: Low-rg, V<sub>GS</sub> = 10 V (Drive)  
 B: V<sub>GS</sub> = 6 V (Drive)    M: Low-rg, V<sub>GS</sub> = 6 V (Drive)  
 C: V<sub>GS</sub> = 4.5 V (Drive)    L: Low-rg, V<sub>GS</sub> = 4.5 V (Drive)  
 5: Fast body diode type

### JEITA registration Product Series

Ex.) N-channel MOSFET    P-channel MOSFET  
**2SK\*\*\*\***    **2SJ\*\*\*\***

# 6. Device Packages

## Surface Mount Type

DPAK+ (6.5 x 9.5)		New PW-Mold (6.5 x 9.5)		DPAK(2-7K1S) (6.6 x 10.0)	
<p>Package dimension unit: mm</p>		<p>Package dimension unit: mm</p>		<p>Package dimension unit: mm</p>	
<p>Land pattern example unit: mm</p>		<p>Land pattern example unit: mm</p>		<p>Land pattern example unit: mm</p>	

DPAK(2-7N1S)		D2PAK (10.35 x 15.3)		DFN8x8 (8.0 x 8.0)	
<p>Package dimension unit: mm</p>		<p>Package dimension unit: mm</p>		<p>Package dimension unit: mm</p>	
<p>Land pattern example unit: mm</p>		<p>Land pattern example unit: mm</p>		<p>Land pattern example unit: mm</p>	

# Surface Mount Type

S-TOGL™ (7.0 x 8.44)	TSON Advance (3.1 x 3.3)	TSON Advance(WF) (3.1 x 3.6) ★
<p>Package dimension unit: mm</p>	<p>Package dimension unit: mm</p>	<p>Package dimension unit: mm</p>
<p>Land pattern example unit: mm</p>	<p>Land pattern example unit: mm</p>	<p>Land pattern example unit: mm</p>

★ Wettable Flank Lead Terminal

SOP-8(2-5R1S) (4.9 x 6.0)	SOP-8(2-6J1S)	DSOP Advance (5.0 x 6.0)
<p>Package dimension unit: mm</p>	<p>Package dimension unit: mm</p>	<p>Package dimension unit: mm</p>
<p>Land pattern example unit: mm</p>	<p>Land pattern example unit: mm</p>	<p>Land pattern example unit: mm</p>

# Surface Mount Type

DSOP Advance(WF)L (5.0 x 6.0) ★		DSOP Advance(WF)M (5.0 x 6.0) ★		SOP Advance (5.0 x 6.0)	
<p>Package dimension unit: mm</p>		<p>Package dimension unit: mm</p>		<p>Package dimension unit: mm</p>	
<p>Land pattern example unit: mm</p>		<p>Land pattern example unit: mm</p>		<p>Land pattern example unit: mm</p>	

★ Wettable Flank Lead Terminal

★ Wettable Flank Lead Terminal

SOP Advance(N) (4.9 x 6.1)		SOP Advance(E) (4.9 x 6.1)		SOP Advance(EWF) (4.9 x 6.47)	
<p>Package dimension unit: mm</p>		<p>Package dimension unit: mm</p>		<p>Package dimension unit: mm</p>	
<p>Land pattern example unit: mm</p>		<p>Land pattern example unit: mm</p>		<p>Land pattern example unit: mm</p>	

## Surface Mount Type

SOP Advance(WF) (5.0 x 6.0) ★	TOLL (9.9 x 11.68)	L-TOGL™ (9.9 x 11.81)
<p>Package dimension unit: mm</p> <p>Bottom View</p>	<p>Package dimension unit: mm</p> <p>Bottom View</p>	<p>Package dimension unit: mm</p> <p>Bottom View</p>
<p>Land pattern example unit: mm</p>	<p>Land pattern example unit: mm</p>	<p>Land pattern example unit: mm</p>

★ Wettable Flank Lead Terminal

## Through Hole Type

TO-220 (10.16 x 15.1)	TO-220SIS (SC-67) (10.0 x 15.0)	TO-3P(N) (SC-65) (15.5 x 20.0)
<p>Package dimension unit: mm</p> <p>Back View</p>	<p>Package dimension unit: mm</p> <p>Back View</p>	<p>Package dimension unit: mm</p> <p>Back View</p>

# Through Hole Type

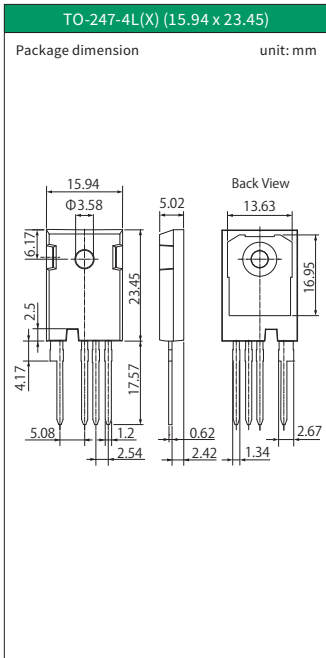
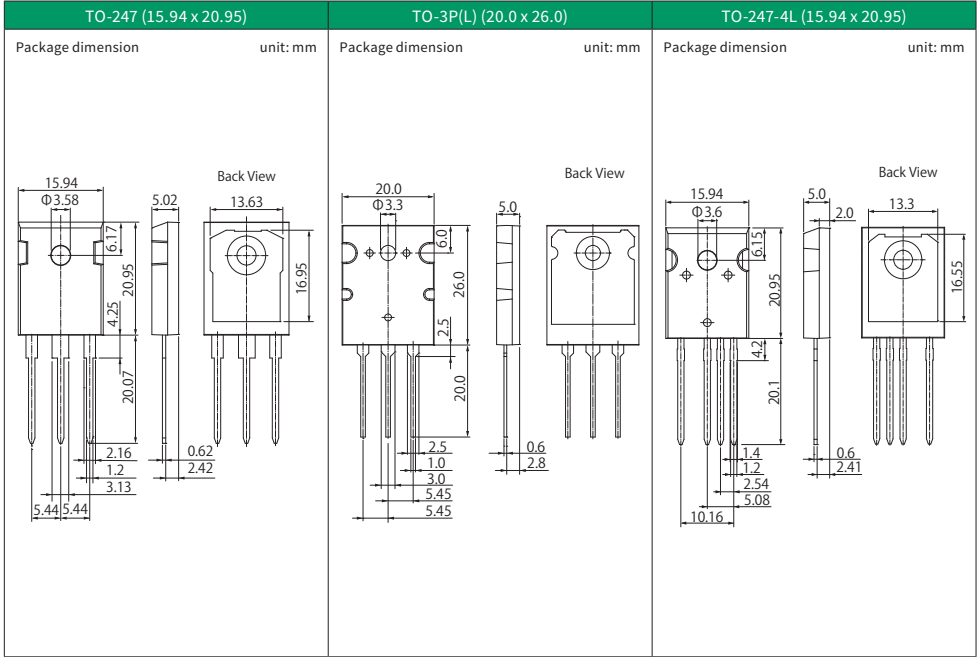







## RESTRICTIONS ON PRODUCT USE

Toshiba Corporation and its subsidiaries and affiliates are collectively referred to as "TOSHIBA". Hardware, software and systems described in this document are collectively referred to as "Product".

- TOSHIBA reserves the right to make changes to the information in this document and related Product without notice.
- This document and any information herein may not be reproduced without prior written permission from TOSHIBA. Even with TOSHIBA's written permission, reproduction is permissible only if reproduction is without alteration/omission.
- Though TOSHIBA works continually to improve Product's quality and reliability, Product can malfunction or fail. Customers are responsible for complying with safety standards and for providing adequate designs and safeguards for their hardware, software and systems which minimize risk and avoid situations in which a malfunction or failure of Product could cause loss of human life, bodily injury or damage to property, including data loss or corruption. Before customers use the Product, create designs including the Product, or incorporate the Product into their own applications, customers must also refer to and comply with (a) the latest versions of all relevant TOSHIBA information, including without limitation, this document, the specifications, the data sheets and application notes for Product and the precautions and conditions set forth in the "TOSHIBA Semiconductor Reliability Handbook" and (b) the instructions for the application with which the Product will be used with or for. Customers are solely responsible for all aspects of their own product design or applications, including but not limited to (a) determining the appropriateness of the use of this Product in such design or applications; (b) evaluating and determining the applicability of any information contained in this document, or in charts, diagrams, programs, algorithms, sample application circuits, or any other referenced documents; and (c) validating all operating parameters for such designs and applications. **TOSHIBA ASSUMES NO LIABILITY FOR CUSTOMERS' PRODUCT DESIGN OR APPLICATIONS.**
- **PRODUCT IS NEITHER INTENDED NOR WARRANTED FOR USE IN EQUIPMENTS OR SYSTEMS THAT REQUIRE EXTRAORDINARILY HIGH LEVELS OF QUALITY AND/OR RELIABILITY, AND/OR A MALFUNCTION OR FAILURE OF WHICH MAY CAUSE LOSS OF HUMAN LIFE, BODILY INJURY, SERIOUS PROPERTY DAMAGE AND/OR SERIOUS PUBLIC IMPACT ("UNINTENDED USE").** Except for specific applications as expressly stated in this document, Unintended Use includes, without limitation, equipment used in nuclear facilities, equipment used in the aerospace industry, lifesaving and/or life supporting medical equipment, equipment used for automobiles, trains, ships and other transportation, traffic signaling equipment, equipment used to control combustions or explosions, safety devices, elevators and escalators, and devices related to power plant. **IF YOU USE PRODUCT FOR UNINTENDED USE, TOSHIBA ASSUMES NO LIABILITY FOR PRODUCT.** For details, please contact your TOSHIBA sales representative or contact us via our website.
- Do not disassemble, analyze, reverse-engineer, alter, modify, translate or copy Product, whether in whole or in part.
- Product shall not be used for or incorporated into any products or systems whose manufacture, use, or sale is prohibited under any applicable laws or regulations.
- The information contained herein is presented only as guidance for Product use. No responsibility is assumed by TOSHIBA for any infringement of patents or any other intellectual property rights of third parties that may result from the use of Product. No license to any intellectual property right is granted by this document, whether express or implied, by estoppel or otherwise.
- **ABSENT A WRITTEN SIGNED AGREEMENT, EXCEPT AS PROVIDED IN THE RELEVANT TERMS AND CONDITIONS OF SALE FOR PRODUCT, AND TO THE MAXIMUM EXTENT ALLOWABLE BY LAW, TOSHIBA (1) ASSUMES NO LIABILITY WHATSOEVER, INCLUDING WITHOUT LIMITATION, INDIRECT, CONSEQUENTIAL, SPECIAL, OR INCIDENTAL DAMAGES OR LOSS, INCLUDING WITHOUT LIMITATION, LOSS OF PROFITS, LOSS OF OPPORTUNITIES, BUSINESS INTERRUPTION AND LOSS OF DATA, AND (2) DISCLAIMS ANY AND ALL EXPRESS OR IMPLIED WARRANTIES AND CONDITIONS RELATED TO SALE, USE OF PRODUCT, OR INFORMATION, INCLUDING WARRANTIES OR CONDITIONS OF MERCHANTABILITY, FITNESS FOR A PARTICULAR PURPOSE, ACCURACY OF INFORMATION, OR NONINFRINGEMENT.**
- Do not use or otherwise make available Product or related software or technology for any military purposes, including without limitation, for the design, development, use, stockpiling or manufacturing of nuclear, chemical, or biological weapons or missile technology products (mass destruction weapons). Product and related software and technology may be controlled under the applicable export laws and regulations including, without limitation, the Japanese Foreign Exchange and Foreign Trade Law and the U.S. Export Administration Regulations. Export and re-export of Product or related software or technology are strictly prohibited except in compliance with all applicable export laws and regulations.
- Please contact your TOSHIBA sales representative for details as to environmental matters such as the RoHS compatibility of Product. Please use in compliance with all applicable laws and regulations that regulate the inclusion or use of controlled substances, including without limitation, the EU RoHS Directive. **TOSHIBA ASSUMES NO LIABILITY FOR DAMAGES OR LOSSES OCCURRING AS A RESULT OF NONCOMPLIANCE WITH APPLICABLE LAWS AND REGULATIONS.**

\* S-TOGL™ and L-TOGL™ are trademarks of Toshiba Electronic Devices & Storage Corporation.

# TOSHIBA

Toshiba Electronic Devices & Storage Corporation  
Toshiba Electronic Device Solutions Corporation

<https://toshiba.semicon-storage.com/>

2026 Rev. 1.1