

The Toshiba logo is displayed in a bold, red, sans-serif font. It is positioned in the upper left corner of the page. The background of the entire page is white, with a large, abstract graphic in the top right corner consisting of a red diagonal band, a blue diagonal band, and a light blue textured area. The bottom half of the page features a large, abstract graphic of overlapping, wavy, translucent blue and purple shapes that create a sense of depth and movement.

**TOSHIBA**

Selection Guide 2025

# Small Signal and Logic Devices





# Contents

<b>1. MOSFETs</b>	<b>3-14</b>
■ <a href="#">Over 500mA Series MOSFETs (Semi-Power Type)</a>	
■ <a href="#">Less than 500mA Series MOSFETs (Standard Type)</a>	
■ <a href="#">MOSFET with Diode</a>	
■ <a href="#">Part Naming Conventions</a>	
<b>2. Bipolar Transistors</b>	<b>15-20</b>
■ <a href="#">General-Purpose Transistors</a>	
■ <a href="#">Bipolar transistor with Diode</a>	
■ <a href="#">Bias Resistor Built-in Transistors (BRTs)</a>	
<b>3. Diodes</b>	<b>21-31</b>
■ <a href="#">Schottky Barrier Diodes (SBDs)</a>	
■ <a href="#">Switching Diodes</a>	
■ <a href="#">TVS Diodes (ESD Protection Diodes)</a>	
■ <a href="#">Zener Diodes for Over Voltage Protection</a>	
■ <a href="#">Part Naming Conventions</a>	
<b>4. Power Management ICs</b>	<b>32-35</b>
■ <a href="#">Low Dropout Regulators (LDO)</a>	
■ <a href="#">Load Switch ICs</a>	
■ <a href="#">N-ch MOSFET Gate driver ICs with OVP function</a>	
■ <a href="#">Power Multiplexer ICs</a>	
■ <a href="#">eFuse ICs</a>	
<b>5. Linear ICs</b>	<b>36-37</b>
■ <a href="#">Thermoflagger™ (Over Temperature Detection IC)</a>	
■ <a href="#">Operational Amplifiers, Comparators</a>	
<b>6. Sensors</b>	<b>38</b>
■ <a href="#">Magnetic Sensors</a>	
<b>7. General Purpose Logic ICs</b>	<b>39-54</b>
<b>7-1 One-Gate Logic ICs (L-MOS)</b>	
<b>7-2 CMOS Logic ICs</b>	
■ <a href="#">Standard Logic 74VHC Series (TSSOP14B / 16B / 20B Package Products)</a>	
■ <a href="#">Standard Logic TC74VHC Series (TSSOP14 / 16 / 20 Package Products)</a>	
■ <a href="#">Standard Logic 74HC Series, 74LCX Series (TSSOP14B / 16B / 20B Package Products)</a>	
■ <a href="#">Standard Logic TC74LCX Series (TSSOP14 / 16 / 20 Package Products)</a>	
■ <a href="#">Standard Logic 74VHC Series (US14 / 16 / 20 Package Products)</a>	
■ <a href="#">Standard Logic 74LCX Series, 74VCX Series (US14 / 16 / 20 Package Products)</a>	
■ <a href="#">Standard Logic 74HC Series, TC4000B Series (SOIC14 / 16 / 20, SOP14 / 16 / 20 Package Products)</a>	
■ <a href="#">Standard Logic TC74VCX Series, TC74LCX Series (TSSOP14 / 16 / 20 / 48 Package Products)</a>	
<b>7-3 Bus Switches</b>	
■ <a href="#">High-Speed Transmission Type</a>	
■ <a href="#">General Purpose Bus Switches</a>	
<b>7-4 Level Shifters</b>	
<b>7-5 Part Naming Conventions</b>	
<b>8. Radio-Frequency Devices</b>	<b>55-57</b>
■ <a href="#">RF Diodes</a>	
■ <a href="#">Part Naming Conventions</a>	
<b>9. Device Packages</b>	<b>58-66</b>

# 1. MOSFETs

## Over 500mA Series MOSFETs (Semi-Power Type)





Package Dimensions (unit: mm)

CST3C	CST3 (SOT-883)	VESM (SOT-723)	UFM (SOT-323F)	ES6 (SOT-563)	UF6 (SOT-363F)	WCSP6C
Bottom View  0.8 x 0.6	Bottom View  1.0 x 0.6	 1.2 x 1.2	 2.0 x 2.1	 1.6 x 1.6	 2.0 x 2.1	Bottom View  1.5 x 1.0

### P-Channel Single MOSFET

Package	Part Number	V <sub>oss</sub> (V)	V <sub>ess</sub> (V)	I <sub>o</sub> (A)	R <sub>DS(ON)</sub> max (mΩ)						Q <sub>g</sub> typ. (nC)	C <sub>iss</sub> typ. (pF)	Note	
					V <sub>GS</sub> = -1.2V	V <sub>GS</sub> = -1.5V	V <sub>GS</sub> = -1.8V	V <sub>GS</sub> = -2.5V	V <sub>GS</sub> = -4V	V <sub>GS</sub> = -10V				
CST3C	SSM3J64CTC	\$ -12	+/-10	-1	11300	1310	890	560	-	370	-	50		
	SSM3J65CTC	\$ -20	+/-10	-0.7	11300	1550	1070	700	-	500	-	48		
CST3	SSM3J56ACT	\$ -20	+/-8	-1.4	4000	900	660	480	-	390	-	1.6	100	
	SSM3J76CT	☆ \$ -20	+/-8	-1.4	4000	900	660	480	-	390	-	1.6	100	Low leakage current
	SSM3J65CT	☆ \$ -20	+/-10	-0.7	11300	1550	1070	700	-	500	-	-	48	
VESM	SSM3J66MFV	# \$ -20	+6/-8	-0.8	4000	900	660	480	-	390	-	1.6	100	
	SSM3J56MFV	\$ -20	+/-8	-0.8	4000	900	660	480	-	390	-	1.6	100	
	SSM3J76MFV	☆ \$ -20	+/-8	-0.8	4000	900	660	480	-	390	-	1.6	100	Low leakage current
WCSP6C	SSM6J771G	\$ -20	+/-12	-5	-	-	-	47.5	-	35	34.7 (@-8V) 31 (@-8.5V)	9.8	870	
ES6	SSM6J216FE	\$ -12	+/-8	-4.8	-	88.1	56	39.3	-	32	-	12.7	1040	
	SSM6J213FE	\$ -20	+/-8	-2.6	-	250	178	133	-	103	-	4.7	290	
	SSM6J215FE	\$ -20	+/-8	-3.4	-	154	104	79	-	59	-	10.4	630	
	SSM6J212FE	\$ -20	+/-8	-4	-	94	65.4	49	-	40.7	-	14.1	970	
	SSM6J207FE	\$ -30	+/-20	-1.4	-	-	-	-	491	-	251	-	137	
	SSM6J214FE	\$ -30	+/-12	-3.6	-	-	149.6	77.6	-	57	50	7.9	560	
UFM	SSM3J132TU	\$ -12	+/-6	-5.4	94	39	29	21	-	17	-	33	2700	
	SSM3J135TU	\$ -20	+/-8	-3	-	260	180	132	-	103	-	4.6	270	
	SSM3J145TU	# \$ -20	+6/-8	-3	-	260	180	132	-	103	-	4.6	270	
	SSM3J134TU	\$ -20	+/-8	-3.2	-	240	168	123	-	93	-	4.7	290	
	SSM3J144TU	# \$ -20	+6/-8	-3.2	-	240	168	123	-	93	-	4.7	290	
	SSM3J130TU	\$ -20	+/-8	-4.4	-	63.2	41.1	31	-	25.8	-	24.8	1800	
	SSM3J140TU	# \$ -20	+6/-8	-4.4	-	63.2	41.1	31	-	25.8	-	24.8	1800	
	SSM3J133TU	\$ -20	+/-8	-5.5	-	88.4	56	39.7	-	29.8	-	12.8	840	
	SSM3J143TU	# \$ -20	+6/-8	-5.5	-	88.4	56	39.7	-	29.8	-	12.8	840	
	SSM3J112TU	\$ -30	+/-20	-1.1	-	-	-	-	790	-	390	-	86	
SSM3J118TU	\$ -30	+/-20	-1.4	-	-	-	-	480	-	240	-	137		
SSM3J117TU	\$ -30	+/-20	-2	-	-	-	-	225	-	117	-	280		
UF6	SSM6J422TU	# \$ -20	+6/-8	-4	-	99.6	67.8	51.4	-	42.7	-	12.8	840	
	SSM6J412TU	\$ -20	+/-8	-4	-	99.6	67.8	51.4	-	42.7	-	12.8	840	
	SSM6J424TU	\$ -20	+6/-8	-6	-	54	36	26	-	22.5	-	23.1	1650	
	SSM6J414TU	\$ -20	+/-8	-6	-	54	36	26	-	22.5	-	23.1	1650	
	SSM6J402TU	\$ -30	+/-20	-2	-	-	-	-	225	-	117	5.3	280	
	SSM6J410TU	\$ -30	+/-20	-2.1	-	-	-	-	393	-	216	2.9	120	
SSM6J401TU	\$ -30	+/-20	-2.5	-	-	-	-	145	-	73	16	730		







☆ New Products  
# AEC-Q101 qualified, \$ With protection Zener diode between gate and source

UDFN6B (SOT-1220)	SOT-23F	S-Mini (SOT-346)	TSOP6F
Bottom View 			
2.0 x 2.0	2.9 x 2.4	2.9 x 2.5	2.9 x 2.8

## P-Channel Single MOSFET

Package	Part Number	V <sub>BS</sub> (V)	V <sub>GS</sub> (V)	I <sub>D</sub> (A)	R <sub>DS(ON)</sub> max (mΩ)							Q <sub>g</sub> typ. (nC)	C <sub>ISS</sub> typ. (pF)	Note
					V <sub>GS</sub> = -1.2 V	V <sub>GS</sub> = -1.5 V	V <sub>GS</sub> = -1.8 V	V <sub>GS</sub> = -2.5 V	V <sub>GS</sub> = -4 V	V <sub>GS</sub> = -4.5 V	V <sub>GS</sub> = -10 V			
UDFN6B	SSM6J512NU	\$ -12	+/-10	-10	-	-	40.1	25.7	20.5 (@-3.6 V)	18.7	16.2 (@-8 V)	19.5	1400	
	SSM6J505NU	\$ -12	+/-6	-12	61	30	21	16	-	12	-	37.6	2700	
	SSM6J511NU	\$ -12	+/-10	-14	-	-	19.2	13.5	11.5 (@-3.6 V)	10	9.1 (@-8 V)	47	3350	
	SSM6J503NU	\$ -20	+/-8	-6	-	89.6	57.9	41.7	-	32.4	-	12.8	840	
	SSM6J502NU	\$ -20	+/-8	-6	-	60.5	38.4	28.3	-	23.1	-	24.8	1800	
	SSM6J501NU	\$ -20	+/-8	-10	-	43	26.5	19	-	15.3	-	29.9	2600	
	SSM6J507NU	\$ -30	+20/-25	-10	-	-	-	-	32	28	20	13.6	1150	
SOT-23F	SSM3J338R	\$ -12	+/-10	-6	-	-	45.3	27.9	21.9 (@-3.6 V)	20.2	17.6 (@-8 V)	19.5	1400	
	SSM3J327R	\$ -20	+/-8	-3.9	-	240	168	123	-	93	-	4.6	290	
	SSM3J377R	# \$ -20	+6/-8	-3.9	-	240	168	123	-	93	-	4.6	290	
	SSM3J331R	\$ -20	+/-8	-4	-	150	100	75	-	55	-	10.4	630	
	SSM3J371R	# \$ -20	+6/-8	-4	-	150	100	75	-	55	-	10.4	630	
	SSM3J328R	\$ -20	+/-8	-6	-	88.4	56	39.7	-	29.8	-	12.8	840	
	SSM3J378R	# \$ -20	+6/-8	-6	-	88.4	56	39.7	-	29.8	-	12.8	840	
	SSM3J355R	\$ -20	+/-10	-6	-	-	52.3	38.8	-	30.1	-	16.6	1030	
	SSM3J358R	\$ -20	+/-10	-6	-	-	49.3	32.8	27.7 (@-3.6 V)	25.3	22.1 (@-8 V)	38.5	1331	
	SSM3J334R	\$ -30	+/-20	-4	-	-	-	-	136	105	71	5.9	280	
	SSM3J374R	# \$ -30	+10/-20	-4	-	-	-	-	136	105	71	5.9	280	
	SSM3J340R	\$ -30	+20/-25	-4	-	-	-	-	86	73	45	6.2	492	
	SSM3J332R	\$ -30	+/-12	-6	-	-	144	72	-	50	42	8.2	560	
	SSM3J372R	# \$ -30	+6/-12	-6	-	-	144	72	-	50	42	8.2	560	
	SSM3J356R	# \$ -60	+10/-20	-2	-	-	-	-	400	360	300	8.3	330	
SSM3J351R	# \$ -60	+10/-20	-3.5	-	-	-	-	184	164	134	15.1	660		
S-Mini	SSM3J325F	\$ -20	+/-8	-2	-	311	231	179	-	150	-	4.6	270	
	SSM3J375F	# \$ -20	+6/-8	-2	-	311	231	179	-	150	-	4.6	270	
	SSM3J352F	\$ -20	+/-12	-2	-	-	443	199	-	136	110	5.1	210	
	SSM3J353F	\$ -30	+20/-25	-2	-	-	-	-	274	232	150	3.4	159	
TSOP6F	SSM6J801R	\$ -20	+6/-8	-6	-	88.4	56	39.7	-	32.5	-	12.8	840	
	SSM6J825R	\$ -30	+10/-20	-4	-	-	-	-	86	73	45	6.2	492	
	SSM6J808R	# -40	+10/-20	-7	-	-	-	-	52	48	35	24.2	1020	

# AEC-Q101 qualified, \$ With protection Zener diode between gate and source

CST3 (SOT-883)	VESM (SOT-723)	SSM (SOT-416)	UFM (SOT-323F)	ES6 (SOT-563)	UF6 (SOT-363F)	WCSP6C
Bottom View 						Bottom View 
1.0 x 0.6	1.2 x 1.2	1.6 x 1.6	2.0 x 2.1	1.6 x 1.6	2.0 x 2.1	1.5 x 1.0

## N-Channel Single MOSFET

Package	Part Number	V <sub>oss</sub> (V)	V <sub>ess</sub> (V)	I <sub>o</sub> (A)	R <sub>DS(on)</sub> max (mΩ)							Q <sub>g</sub> typ. (nC)	C <sub>iss</sub> typ. (pF)	Note
					V <sub>GS</sub> = 1.2 V	V <sub>GS</sub> = 1.5 V	V <sub>GS</sub> = 1.8 V	V <sub>GS</sub> = 2.5 V	V <sub>GS</sub> = 4 V	V <sub>GS</sub> = 4.5 V	V <sub>GS</sub> = 10 V			
CST3	SSM3K56CT	\$ 20	+/-8	0.8	-	840	480	300	-	235	-	1	55	
	SSM3K56ACT	\$ 20	+/-8	1.4	-	840	480	300	-	235	-	1	55	
	SSM3K76CT ☆	\$ 20	+/-8	1.4	-	840	480	300	-	235	-	1	55	Low leakage current
VESM	SSM3K36MFV	\$ 20	+/-10	0.5	-	1520	1140	850	-	660	630 (@5 V)	1.23	46	
	SSM3K56MFV	\$ 20	+/-8	0.8	-	840	480	300	-	235	-	1	55	
	SSM3K76MFV ☆	\$ 20	+/-8	0.8	-	840	480	300	-	235	-	1	55	Low leakage current
WCSP6C	SSM6K781G	12	+/-8	7	-	124	47.4	23.2	-	18	-	5.4	600	
SSM	SSM3K36FS	\$ 20	+/-10	0.5	-	1520	1140	850	-	660	630 (@5 V)	1.23	46	
	SSM3K56FS	\$ 20	+/-8	0.8	-	840	480	300	-	235	-	1	55	
	SSM3K76FS ☆	\$ 20	+/-8	0.8	-	840	480	300	-	235	-	1	55	Low leakage current
ES6	SSM6K217FE	\$ 40	+/-12	1.8	-	-	400	248	218 (@3.6 V) 211 (@4.2 V)	208	195 (@8 V)	1.1	130	
UFM	SSM3K36TU	\$ 20	+/-10	0.5	-	1520	1140	850	-	660	630 (@5 V)	1.23	46	
	SSM3K62TU #	\$ 20	+/-8	0.8	432	139	89	68	-	57	-	2	177	
	SSM3K122TU	\$ 20	+/-10	2	-	304	211	161	123	-	-	3.4	195	
	SSM3K121TU	\$ 20	+/-10	3.2	-	140	93	63	48	-	-	5.9	400	
	SSM3K123TU	\$ 20	+/-10	4.2	-	66	43	32	28	-	-	13.6	1010	
	SSM3K127TU	\$ 30	+/-12	2	-	-	286	167	123	-	-	1.5	123	
	SSM3K116TU	\$ 30	+/-12	2.2	-	-	-	135	-	100	-	-	245	
	SSM3K131TU	30	+/-20	6	-	-	-	-	-	41.5	27.6	10.1	450	
	SSM3H137TU	\$ 34	+/-20	2	-	-	-	-	295	280	240	3	119	Built-in Active Clamp Zener
	SSM3K2615TU	\$ 60	+/-20	2	-	-	-	580 (@3.3 V)	440	-	300	6	150	
	SSM3K341TU #	\$ 60	+/-20	6	-	-	-	-	69	51	36	9.3	550	T <sub>ch</sub> = 175 °C
SSM3K361TU #	\$ 100	+/-20	3.5	-	-	-	-	-	92	69	3.2	430	T <sub>ch</sub> = 175 °C	
UF6	SSM6K405TU	\$ 20	+/-10	2	-	307	214	164	126	-	-	3.4	195	
	SSM6K404TU	\$ 20	+/-10	3	-	147	100	70	55	-	-	5.9	400	
	SSM6K403TU	\$ 20	+/-10	4.2	-	66	43	32	28	-	-	16.8	1050	
	SSM6K406TU	\$ 30	+/-20	4.4	-	-	-	-	-	38.5	25	12.4	490	
	SSM6K407TU #	\$ 60	+/-20	2	-	-	-	-	440	-	300	6	150	

☆ New Products

# AEC-Q101 qualified, \$ With protection Zener diode between gate and source





SOT-23F	TSOP6F	UDFN6B (SOT-1220)
		
2.9 x 2.4	2.9 x 2.8	2.0 x 2.0

Bottom View

## N-Channel Single MOSFET

Package	Part Number	V <sub>BS</sub> (V)	V <sub>ES</sub> (V)	I <sub>D</sub> (A)	R <sub>DS(ON)</sub> max (mΩ)							Q <sub>g</sub> typ. (nC)	C <sub>iss</sub> typ. (pF)	Note	
					V <sub>GS</sub> = 1.2 V	V <sub>GS</sub> = 1.5 V	V <sub>GS</sub> = 1.8 V	V <sub>GS</sub> = 2.5 V	V <sub>GS</sub> = 4 V	V <sub>GS</sub> = 4.5 V	V <sub>GS</sub> = 10 V				
UDFN6B	SSM6K518NU	\$ 20	+/-8	6	-	108	74	45	-	33	-	3.6	410		
	SSM6K517NU	\$ 30	+12/-8	6	-	-	82	53	-	39.1	-	3.2	310		
	SSM6K504NU	\$ 30	+/-20	9	-	-	-	-	-	26	19.5	4.8	620		
	SSM6K513NU	\$ 30	+/-20	15	-	-	-	-	-	12	8.9	7.5	1130		
	SSM6K516NU	\$ 30	+20/-12	6	-	-	-	-	-	64	46	2.5	280		
	SSM6K514NU	\$ 40	+/-20	12	-	-	-	-	-	17.3	11.6	7.5	1110		
	SSM6K388NU★	\$ 60	+/-20	2	-	-	-	-	-	98	82	TBD	TBD		
	SSM6K389NU★	\$ 60	+/-20	2	-	-	-	-	-	200	155	TBD	TBD		
	SSM6K341NU	\$ 60	+/-20	6	-	-	-	-	-	69	51	36	9.3	550	
	SSM6K387NU★	\$ 100	+/-20	2	-	-	-	-	-	200	125	3.6	242		
SOT-23F	SSM6K361NU	\$ 100	+/-20	3.5	-	-	-	-	-	92	69	3.2	430		
	SSM3K344R	\$ 20	+/-8	3	-	232	139	91	-	71	-	2	153		
	SSM3K345R	\$ 20	+/-8	4	-	108	74	45	-	33	-	3.6	410		
	SSM3K324R	\$ 30	+/-12	4	-	-	109	72	-	56	-	2.2	200		
	SSM3K376R	# \$ 30	+12/-8	4	-	-	109	72	-	56	-	2.2	200		
	SSM3K336R	\$ 30	+/-20	3	-	-	-	-	-	140	95	1.7	126		
	SSM3K333R	\$ 30	+/-20	6	-	-	-	-	-	42	28	3.4	436		
	SSM3K335R	\$ 30	+/-20	6	-	-	-	-	-	56	38	2.7	340		
	SSM3K347R	\$ 38	+/-20	2	-	-	-	-	-	480	410	340	2.5	86	Built-in Active Clamp Zener
	SSM3K337R	\$ 38	+/-20	2	-	-	-	-	-	200	176	150	3	120	Built-in Active Clamp Zener
	SSM3K339R	\$ 40	+/-12	2	-	-	390	238	208 (@3.6V) 201 (@4.2V)	198	185 (@8V)	1.1	130		
	SSM3K357R	\$ 60	+/-12	0.65	-	-	-	2400 (@3V)	-	1800 (@5V)	-	1.5	43	43	Built-in Gate-Drain Zener
	SSM3K2615R	\$ 60	+/-20	2	-	-	-	580 (@3.3V)	440	-	300	6	150		
	SSM3K388R★	\$ 60	+/-20	2	-	-	-	-	-	98	82	TBD	TBD		
	SSM3K389R★	\$ 60	+/-20	2	-	-	-	-	-	200	155	TBD	TBD		
	SSM3K318R	\$ 60	+/-20	2.5	-	-	-	-	-	145	107	7	235		
	SSM3K341R#	\$ 60	+/-20	6	-	-	-	-	-	69	51	36	9.3	550	T <sub>ch</sub> = 175 °C
SSM3K387R★	\$ 100	+/-20	2	-	-	-	-	-	200	125	3.6	242			
SSM3K361R#	\$ 100	+/-20	3.5	-	-	-	-	-	92	69	3.2	430	T <sub>ch</sub> = 175 °C		
TSOP6F	SSM6K824R	\$ 20	+/-8	6	-	108	74	45	-	33	-	3.6	410		
	SSM6K818R	\$ 30	+/-20	15	-	-	-	-	-	12	8.9	7.5	1130		
	SSM6K804R	\$ 40	+/-20	12	-	-	-	-	-	18	12	7.5	1110		
	SSM6K388R★	\$ 60	+/-20	2	-	-	-	-	-	98	82	TBD	TBD		
	SSM6K389R★	\$ 60	+/-20	2	-	-	-	-	-	200	155	TBD	TBD		
	SSM6K809R#	\$ 60	+/-20	6	-	-	-	-	-	69	51	36	9.3	550	T <sub>ch</sub> = 175 °C
	SSM6K387R★	\$ 100	+/-20	2	-	-	-	-	-	200	125	3.6	242		
	SSM6K810R#	\$ 100	+/-20	3.5	-	-	-	-	-	92	69	3.2	430	T <sub>ch</sub> = 175 °C	
	SSM6K819R#	\$ 100	+/-20	10	-	-	-	-	-	36.4	25.8	8.5	1110	T <sub>ch</sub> = 175 °C	

★ Under Development (The specification is subject to change without notice.)  
# AEC-Q101 qualified, \$ With protection Zener diode between gate and source

ES6 (SOT-563)	UF6 (SOT-363F)	UDFN6 (SOT-1118)	DFN2020(WF)
			
1.6 x 1.6	2.0 x 2.1	2.0 x 2.0	2.0 x 2.0

## Dual MOSFET

Package	Polarity	Part Number	V <sub>oss</sub> (V)	V <sub>ess</sub> (V)	I <sub>D</sub> (A)	R <sub>DS(ON)</sub> max (mΩ)						Q <sub>g</sub> typ. (nC)	C <sub>iss</sub> typ. (pF)	Note	
						V <sub>GS</sub>   = 1.2 V	V <sub>GS</sub>   = 1.5 V	V <sub>GS</sub>   = 1.8 V	V <sub>GS</sub>   = 2.5 V	V <sub>GS</sub>   = 4 V	V <sub>GS</sub>   = 4.5 V				V <sub>GS</sub>   = 10 V
ES6	P-ch x 2	SSM6P41FE	\$ -20	+/-8	-0.72	-	1040	670	440	-	300	-	1.76	110	
		SSM6P56FE	\$ -20	+/-8	-0.8	4000	900	660	480	-	390	-	1.6	100	
		SSM6P76FE ☆	\$ -20	+/-8	-0.8	4000	900	660	480	-	390	-	1.6	100	Low leakage current
	N-ch x 2	SSM6N36FE	\$ 20	+/-10	0.5	-	1520	1140	850	-	660	630 (@5V)	1.23	46	
		SSM6N56FE	\$ 20	+/-8	0.8	-	840	480	300	-	235	-	1	55	
		SSM6N76FE ☆	\$ 20	+/-8	0.8	-	840	480	300	-	235	-	1	55	Low leakage current
	N-ch + P-ch	SSM6L14FE	\$	+/-10	0.8	-	600	450	330	-	240	-	2	90	
SSM6L56FE		\$	+/-8	0.8	-	1040	670	440	-	300	-	1.76	110		
		SSM6L56FE	\$	+/-8	0.8	-	840	480	300	-	235	-	1	55	
UDFN6	P-ch x 2	SSM6P47NU	\$ -20	+/-8	-4	-	242	170	125	-	95	-	4.6	290	
		SSM6P69NU	\$ -20	+6/-12	-4	-	-	157	76	-	56	45	6.74	480	
		SSM6P49NU	\$ -20	+/-12	-4	-	-	157	76	-	56	45	6.74	480	
	N-ch x 2	SSM6N61NU	\$ 20	+/-8	4	-	108	74	45	-	33	-	3.6	410	
		SSM6N55NU	\$ 30	+/-20	4	-	-	-	-	-	64	46	2.5	280	
		SSM6N67NU	\$ 30	+12/-8	4	-	-	82	53	-	39.1	-	3.2	310	
		SSM6N68NU	\$ 30	+12/-8	4	-	-	180	117	-	84	-	1.8	129	
		SSM6N57NU	\$ 30	+/-12	4	-	-	82	53	-	39.1	-	3.2	310	
	N-ch + P-ch	SSM6N58NU	\$ 30	+/-12	4	-	-	180	117	-	84	-	1.8	129	
		SSM6L61NU	\$	+/-8	4	-	108	74	45	-	33	-	3.6	410	
		SSM6L61NU	\$	+/-12	-4	-	-	157	76	-	56	45	6.74	480	
DFN2020 (WF)	N-ch x 2	XSM6N65NW ★ #	\$ 30	+20/-12	4	-	-	-	-	64	-	2.5	280	Automotive equipment	
		XSM6N67NW ★ #	\$ 30	+12/-8	4	-	-	82	53	-	39.1	-	3.2	310	
UF6	P-ch x 2	SSM6P39TU	\$ -20	+/-8	-1.5	-	-	430	294	213	-	-	6.4	250	
		SSM6P40TU	\$ -30	+/-20	-1.4	-	-	-	-	403	-	226	2.9	120	
	N-ch x 2	SSM6N36TU	\$ 20	+/-10	0.5	-	1520	1140	850	-	660	630 (@5V)	1.23	46	
		SSM6N62TU	\$ 20	+/-8	0.8	456	173	120	98	-	85	-	2	177	
		SSM6N39TU	\$ 20	+/-10	1.6	-	247	190	139	119	-	-	7.5	260	
		SSM6N24TU	\$ 30	+/-12	0.5	-	-	-	180	-	145	-	-	245	
		SSM6N40TU	\$ 30	+/-20	1.6	-	-	-	-	182	-	122	5.1	180	
	N-ch + P-ch	SSM6L39TU	\$	+/-10	1.6	-	247	190	139	119	-	-	7.5	260	
			\$	+/-8	-1.5	-	-	430	294	213	-	-	6.4	250	
		SSM6L12TU	\$	+/-12	0.5	-	-	-	180	-	145	-	-	245	
\$			+/-12	-0.5	-	-	-	430	260	-	-	-	218		
SSM6L40TU	\$	+/-20	1.6	-	-	-	-	182	-	122	5.1	180			
	\$	+/-20	-1.4	-	-	-	-	403	-	226	2.9	120			

☆ New Products, ★ Under Development (The specification is subject to change without notice.)  
# AEC-Q101 qualified, \$ With protection Zener diode between gate and source

US6 (SOT-363)	TSOP6F	TCSPA- 172101	TCSPAC- 153001	TCSPED- 302701	TCSPAG- 341501
					
Bottom View	Bottom View	Bottom View	Bottom View	Bottom View	Bottom View
2.0 x 2.1	2.9 x 2.8	2.14 x 1.67	2.98 x 1.49	3.0 x 2.74	3.37 x 1.47

## Dual MOSFET

Package	Polarity	Part Number	V <sub>bss</sub> or V <sub>SSS</sub> (V)	V <sub>GSS</sub> (V)	I <sub>D</sub> or I <sub>L</sub> (A)	R <sub>DS(ON)</sub> max or R <sub>SS(ON)</sub> max (mΩ)						Q <sub>g</sub> typ. (nC)	C <sub>iss</sub> typ. (pF)	Note			
						V <sub>Gs</sub>   = 1.2 V	V <sub>Gs</sub>   = 1.5 V	V <sub>Gs</sub>   = 1.8 V	V <sub>Gs</sub>   = 2.5 V	V <sub>Gs</sub>   = 4 V	V <sub>Gs</sub>   = 4.5 V				V <sub>Gs</sub>   = 10 V		
US6	N-ch x 2	SSM6N43FU	\$	20	+/-10	0.5	-	1520	1140	850	-	660	630 (@5 V)	1.23	46		
TSOP6F	N-ch x 2	SSM6N357R	\$	60	+/-12	0.65	-	-	-	2400 (@3 V)	-	1800 (@5 V)	-	1.5	43	Built-in Gate-Drain Zener	
		SSM6N815R	\$	100	+/-20	2	-	-	-	-	180	142	103	3.1	290		
		SSM6N813R	# \$	100	+/-20	3.5	-	-	-	-	-	154	112	3.6	242	T <sub>ch</sub> = 175 °C	
	P-ch x 2	SSM6P816R	\$	-20	+/-10	-6	-	-	52.3	38.8	-	30.1	-	16.6	1030		
		N-ch + P-ch	SSM6L807R	\$	30	+/-12	4	-	-	82	53	-	39.1	-	3.2	310	
			SSM6L820R	# \$	30	+/-12	-4	-	-	157	76	-	56	45	6.74	480	
			\$	30	+12/-8	4	-	-	82	53	-	39.1	-	3.2	310		
			# \$	-20	+6/-12	-4	-	-	157	76	-	56	45	6.7	480		
TCSPA- 172101	N-ch x 2	SSM6N951L	\$	12	+/-8	8	-	-	-	10	5.5 (@3.8 V)	5.1	-	26	-	Drain common	
TCSPAC- 153001	N-ch x 2	SSM10N954L	\$	12	+/-8	13.5	-	-	-	6.1	2.85 (@3.8 V)	2.75	-	25	-	Drain common	
TCSPED- 302701	N-ch x 2	SSM14N956L	☆ \$	12	+/-8	20	-	-	-	3.2	1.5 (@3.8 V)	1.35	-	76	-	Drain common	
TCSPAG- 341501	N-ch x 2	SSM10N961L	☆ \$	30	+/-20	14	-	-	-	-	-	17.6	12.8	8.8	-	Drain common	

☆ New Products

# AEC-Q101 qualified, \$ With protection Zener diode between gate and source



## ■ Less than 500mA Series MOSFETs (Standard Type)

Package Dimensions (unit: mm)

CST3C	CST3 (SOT-883)	VESM (SOT-723)	SSM (SOT-416)	UFM (SOT-323F)	USM (SOT-323)	S-Mini (SOT-346)
Bottom View	Bottom View					
0.8 x 0.6	1.0 x 0.6	1.2 x 1.2	1.6 x 1.6	2.0 x 2.1	2.0 x 2.1	2.9 x 2.5



### P-Channel Single MOSFET

Package	Part Number	V <sub>DS</sub> (V)	V <sub>GS</sub> (V)	I <sub>D</sub> (A)	R <sub>DS(ON)</sub> max (Ω)						Note	
					V <sub>GS</sub> = -1.2 V	V <sub>GS</sub> = -1.5 V	V <sub>GS</sub> = -1.8 V	V <sub>GS</sub> = -2.5 V	V <sub>GS</sub> = -4 V	V <sub>GS</sub> = -4.5 V		V <sub>GS</sub> = -10 V
CST3C	SSM3J35CTC	\$ -20	+/-10	-0.25	20	4	2.9	2.1	-	1.4	-	
	SSM3J78CTC ☆	\$ -20	+/-10	-0.25	20	4	2.9	2.1	-	1.4	-	Low leakage current
CST3	SSM3J35CT	\$ -20	+/-10	-0.1	44	22	-	11	8	-	-	
	SSM3J16CT ●	\$ -20	+/-10	-0.1	-	45	-	12	8	-	-	⇒ SSM3J35CT
	SSM3J15CT	\$ -30	+/-20	-0.1	-	-	-	32	12	-	-	
VESM	SSM3J35MFV	\$ -20	+/-10	-0.1	44	22	-	11	8	-	-	⇒ SSM3J35AMFV
	SSM3J36MFV	\$ -20	+/-8	-0.33	-	3.6	2.7	1.6 (@-2.8V)	-	1.31	-	⇒ SSM3J56MFV
	SSM3J35AMFV	\$ -20	+/-10	-0.25	20	4	2.9	2.1	-	1.4	-	
	SSM3J78MFV ☆	\$ -20	+/-10	-0.25	20	4	2.9	2.1	-	1.4	-	Low leakage current
	SSM3J15FV	\$ -30	+/-20	-0.1	-	-	-	32	12	-	-	
SSM	SSM3J35FS	\$ -20	+/-10	-0.1	44	22	-	11	8	-	-	⇒ SSM3J35AFS
	SSM3J35AFS	\$ -20	+/-10	-0.25	20	4	2.9	2.1	-	1.4	-	
	SSM3J78FS ☆	\$ -20	+/-10	-0.25	20	4	2.9	2.1	-	1.4	-	Low leakage current
	SSM3J36FS	\$ -20	+/-8	-0.33	-	3.6	2.7	1.6 (@-2.8V)	-	1.31	-	
	SSM3J15FS	\$ -30	+/-20	-0.1	-	-	-	32	12	-	-	
UFM	SSM3J36TU	\$ -20	+/-8	-0.33	-	3.6	2.7	1.6 (@-2.8V)	-	1.31	-	
USM	SSM3J15FU	\$ -30	+/-20	-0.1	-	-	-	32	12	-	-	
S-Mini	SSM3J15F	\$ -30	+/-20	-0.1	-	-	-	32	12	-	-	
	2SJ305	\$ -30	+/-20	-0.2	-	-	-	4	-	-	-	
	SSM3J168F #	\$ -60	+10/-20	-0.4	-	-	-	-	2	1.9	1.55	

☆ New Products

● Recommended Another New Product

# AEC-Q101 qualified, \$ With protection Zener diode between gate and source

CST3C	CST3 (SOT-883)	VESM (SOT-723)	SSM (SOT-416)	USM (SOT-323)	SOT23 (SOT-23)	S-Mini (SOT-346)
Bottom View 	Bottom View 					
0.8 x 0.6	1.0 x 0.6	1.2 x 1.2	1.6 x 1.6	2.0 x 2.1	2.9 x 2.4	2.9 x 2.5

## N-Channel Single MOSFET

Package	Part Number	V <sub>BS</sub> (V)	V <sub>ES</sub> (V)	I <sub>D</sub> (A)	R <sub>DS(ON)</sub> max (Ω)								Note		
					V <sub>ES</sub> = 1.2 V	V <sub>GS</sub> = 1.5 V	V <sub>ES</sub> = 1.8 V	V <sub>ES</sub> = 2.5 V	V <sub>GS</sub> = 4 V	V <sub>ES</sub> = 4.5 V	V <sub>ES</sub> = 5 V	V <sub>GS</sub> = 10 V			
CST3C	SSM3K35CTC	\$	20	+/-10	0.25	9	3.1	2.4	1.6	-	1.1	-	-		
	SSM3K78CTC ☆	\$	20	+/-10	0.25	9	3.1	2.4	1.6	-	1.1	-	-	Low leakage current	
	SSM3K15ACT	\$	30	+/-20	0.1	-	-	-	6	3.6	-	-	-		
	SSM3K79CTC ☆	\$	30	+/-20	0.1	-	-	-	6	3.6	-	-	-	Low leakage current	
	SSM3K72CTC	\$	60	+/-20	0.15	-	-	-	5.7 (typ.)	-	4.7	4.4	3.9		
CST3	SSM3K16CT	\$	20	+/-10	0.1	-	15	-	4	3	-	-	-		
	SSM3K35CT	\$	20	+/-10	0.18	20	8	-	4	3	-	-	-		
	SSM3K37CT	\$	20	+/-10	0.2	-	5.6	4.05	3.02	-	2.2	-	-		
	SSM3K77CT ☆	\$	20	+/-10	0.2	-	5.6	4.05	3.1	-	2.2	-	-	Low leakage current	
	SSM3K15CT ●	\$	30	+/-20	0.1	-	-	-	7	4	-	-	-	⇒ SSM3K15ACT	
	SSM3K15ACT	\$	30	+/-20	0.1	-	-	-	6	3.6	-	-	-		
	SSM3K79CT ☆	\$	30	+/-20	0.1	-	-	-	6	3.6	-	-	-	Low leakage current	
SSM3K72KCT	\$	60	+/-20	0.4	-	-	-	-	-	1.75	1.65	1.5			
VESM	SSM3K16FV	\$	20	+/-10	0.1	-	15	-	4	3	-	-	-		
	SSM3K35MFV	\$	20	+/-10	0.18	20	8	-	4	3	-	-	-	⇒ SSM3K35AMFV	
	SSM3K37MFV	\$	20	+/-10	0.25	-	5.6	4.05	3.02	-	2.2	-	-		
	SSM3K77MFV ☆	\$	20	+/-10	0.25	-	5.6	4.05	3.1	-	2.2	-	-	Low leakage current	
	SSM3K35AMFV	\$	20	+/-10	0.25	9	3.1	2.4	1.6	-	1.1	-	-		
	SSM3K78MFV ☆	\$	20	+/-10	0.25	9	3.1	2.4	1.6	-	1.1	-	-	Low leakage current	
	SSM3K15AMFV	\$	30	+/-20	0.1	-	-	-	6	3.6	-	-	-		
	SSM3K79MFV ☆	\$	30	+/-20	0.1	-	-	-	6	3.6	-	-	-	Low leakage current	
	SSM3K44MFV	\$	30	+/-20	0.1	-	-	-	7	4	-	-	-		
	SSM3K16FS	\$	20	+/-10	0.1	-	15	-	4	3	-	-	-	⇒ SSM3K37FS	
SSM	SSM3K35FS	\$	20	+/-10	0.18	20	8	-	4	3	-	-	-	⇒ SSM3K35AFS	
	SSM3K37FS	\$	20	+/-10	0.2	-	5.6	4.05	3.02	-	2.2	-	-		
	SSM3K77FS ☆	\$	20	+/-10	0.2	-	5.6	4.05	3.1	-	2.2	-	-	Low leakage current	
	SSM3K35AFS	\$	20	+/-10	0.25	9	3.1	2.4	1.6	-	1.1	-	-		
	SSM3K78FS ☆	\$	20	+/-10	0.25	9	3.1	2.4	1.6	-	1.1	-	-	Low leakage current	
	SSM3K15FS ●	\$	30	+/-20	0.1	-	-	-	7	4	-	-	-	⇒ SSM3K15AFS	
	SSM3K44FS	\$	30	+/-20	0.1	-	-	-	7	4	-	-	-		
	SSM3K15AFS	\$	30	+/-20	0.1	-	-	-	6	3.6	-	-	-		
	SSM3K79FS ☆	\$	30	+/-20	0.1	-	-	-	6	3.6	-	-	-	Low leakage current	
	SSM3K72CF	\$	60	+/-20	0.17	-	-	-	-	-	4.7	4.4	3.9		
	SSM3K72KFS #	\$	60	+/-20	0.3	-	-	-	-	-	1.75	1.65	1.5		
	USM	SSM3K16FU	\$	20	+/-10	0.1	-	15	-	4	3	-	-	-	
		SSM3K15FU	\$	30	+/-20	0.1	-	-	-	7	4	-	-	-	⇒ SSM3K15AFU
SSM3K15AFU		\$	30	+/-20	0.1	-	-	-	6	3.6	-	-	-		
SSM3K79FU ☆		\$	30	+/-20	0.1	-	-	-	6	3.6	-	-	-	Low leakage current	
SSM3K48FU ●		\$	30	+/-20	0.1	-	-	-	5.4	3.2	-	-	-	⇒ SSM3K15AFU	
SSM3K09FU		\$	30	+/-20	0.4	-	-	-	1.7 (@3.3V)	1.2	-	-	0.7		
SSM3K17FU		\$	50	+/-7	0.1	-	-	-	40	20	-	-	-		
SOT23	SSM3K7002CFU	\$	60	+/-20	0.17	-	-	-	-	-	4.7	4.4	3.9		
	SSM3K7002KFU #	\$	60	+/-20	0.4	-	-	-	-	-	1.75	1.65	1.5		
	T2N7002AK	\$	60	+/-20	0.2	-	-	-	-	-	4.7	4.4	3.9		
	T2N7002BK	\$	60	+/-20	0.4	-	-	-	-	-	1.75	1.65	1.5		
S-Mini	SSM3K15F	\$	30	+/-20	0.1	-	-	-	7	4	-	-	-		
	2SK2009	\$	30	+/-20	0.2	-	-	-	2	-	-	-	-		
	SSM3K7002KF	#	60	+/-20	0.4	-	-	-	-	-	1.75	1.65	1.5		

☆ New Products

● Recommended Another New Product, # AEC-Q101 qualified, \$ With protection Zener diode between gate and source

ESV (SOT-553)	ES6 (SOT-563)	USV (SOT-353)	UF6 (SOT-363F)
			
1.6 x 1.6	1.6 x 1.6	2.0 x 2.1	2.0 x 2.1

## Dual MOSFET

Package	Polarity	Part Number	V <sub>oss</sub> (V)	V <sub>ess</sub> (V)	I <sub>b</sub> (A)	R <sub>DS(ON)</sub> max (Ω)								Note
						V <sub>es</sub>   = 1.2 V	V <sub>es</sub>   = 1.5 V	V <sub>es</sub>   = 1.8 V	V <sub>es</sub>   = 2.5 V	V <sub>es</sub>   = 4 V	V <sub>es</sub>   = 4.5 V	V <sub>es</sub>   = 5 V	V <sub>es</sub>   = 10 V	
ESV	P-ch x 2	SSM5P16FE	\$ -20	+/-10	-0.1	-	45	-	12	8	-	-	-	
	N-ch x 2	SSM5N16FE	\$ 20	+/-10	0.1	-	15	-	4	3	-	-	-	
		SSM5N15FE	\$ 30	+/-20	0.1	-	-	-	7	4	-	-	-	
ES6	P-ch x 2	SSM6P35FE	\$ -20	+/-10	-0.1	44	22	-	11	8	-	-	-	⇒ SSM6P35AFE
		SSM6P35AFE	\$ -20	+/-10	-0.25	20	4	2.9	2.1	-	1.4	-	-	
		SSM6P78FE ☆	\$ -20	+/-10	-0.25	20	4	2.9	2.1	-	1.4	-	-	Low leakage current
		SSM6P36FE	\$ -20	+/-8	-0.33	-	3.6	2.7	1.6 (@-2.8V)	-	1.31	-	-	
		SSM6P15FE	\$ -30	+/-20	-0.1	-	-	-	32	12	-	-	-	
		N-ch x 2	SSM6N16FE	\$ 20	+/-10	0.1	-	15	-	4	3	-	-	-
	SSM6N35FE		\$ 20	+/-10	0.18	20	8	-	4	3	-	-	-	⇒ SSM6N35AFE
	SSM6N37FE		\$ 20	+/-10	0.25	-	5.6	4.05	3.02	-	2.2	-	-	
	SSM6N77FE ☆		\$ 20	+/-10	0.25	-	5.6	4.05	3.1	-	2.2	-	-	Low leakage current
	SSM6N35AFE		\$ 20	+/-10	0.25	9	3.1	2.4	1.6	-	1.1	-	-	
	SSM6N78FE ☆		\$ 20	+/-10	0.25	9	3.1	2.4	1.6	-	1.1	-	-	Low leakage current
	SSM6N44FE		\$ 30	+/-20	0.1	-	-	-	7	4	-	-	-	
	SSM6N15AFE		\$ 30	+/-20	0.1	-	-	-	6	3.6	-	-	-	
	SSM6N79FE ☆		\$ 30	+/-20	0.1	-	-	-	6	3.6	-	-	-	Low leakage current
	N-ch + P-ch	SSM6L35FE	\$ 20	+/-10	0.18	20	8	-	4	3	-	-	-	
\$ -20			+/-10	-0.1	44	22	-	11	8	-	-	-		
SSM6L36FE		\$ -20	+/-8	-0.33	-	3.6	2.7	1.6 (@-2.8V)	-	1.31	-	-		
USV	P-ch x 2	SSM5P15FU	\$ -30	+/-20	-0.1	-	-	-	32	12	-	-	-	
	N-ch x 2	SSM5N16FU	\$ 20	+/-10	0.1	-	15	-	4	3	-	-	-	
		SSM5N15FU	\$ 30	+/-20	0.1	-	-	-	7	4	-	-	-	
UF6	P-ch x 2	SSM6P36TU	\$ -20	+/-8	-0.33	-	3.6	2.7	1.6 (@-2.8V)	-	1.31	-	-	
	N-ch + P-ch	SSM6L36TU	\$ 20	+/-10	0.5	-	1.52	1.14	0.85	-	0.66	0.63	-	
			\$ -20	+/-8	-0.33	-	3.6	2.7	1.6 (@-2.8V)	-	1.31	-	-	

☆ New Products

# AEC-Q101 qualified, \$ With protection Zener diode between gate and source

US6  
(SOT-363)



2.0 x 2.1

## Dual MOSFET



Package	Polarity	Part Number	V <sub>oss</sub> (V)	V <sub>ess</sub> (V)	I <sub>o</sub> (A)	R <sub>DS(on)</sub> max (Ω)								Note	
						V <sub>GS</sub>   = 1.2V	V <sub>GS</sub>   = 1.5V	V <sub>GS</sub>   = 1.8V	V <sub>GS</sub>   = 2.5V	V <sub>GS</sub>   = 4V	V <sub>GS</sub>   = 4.5V	V <sub>GS</sub>   = 5V	V <sub>GS</sub>   = 10V		
US6	P-ch x 2	SSM6P35FU	\$	-20	+/-10	-0.1	44	22	-	11	8	-	-	-	⇒ SSM6P35AFU
		SSM6P35AFU	\$	-20	+/-10	-0.25	20	4	2.9	2.1	-	1.4	-	-	
		SSM6P78FU ☆	\$	-20	+/-10	-0.25	20	4	2.9	2.1	-	1.4	-	-	Low leakage current
		SSM6P15FU	\$	-30	+/-20	-0.1	-	-	-	32	12	-	-	-	
	N-ch x 2	SSM6N16FU	\$	20	+/-10	0.1	-	15	-	4	3	-	-	-	
		SSM6N35FU	\$	20	+/-10	0.18	20	8	-	4	3	-	-	-	⇒ SSM6N35AFU
		SSM6N35AFU	\$	20	+/-10	0.25	9	3.1	2.4	1.6	-	1.1	-	-	
		SSM6N78FU ☆	\$	20	+/-10	0.25	9	3.1	2.4	1.6	-	1.1	-	-	Low leakage current
		SSM6N37FU	\$	20	+/-10	0.25	-	5.6	4.05	3.02	-	2.2	-	-	
		SSM6N77FU ☆	\$	20	+/-10	0.25	-	5.6	4.05	3.1	-	2.2	-	-	Low leakage current
		SSM6N48FU ●	\$	30	+/-20	0.1	-	-	-	5.4	3.2	-	-	-	⇒ SSM6N15AFU
		SSM6N44FU	\$	30	+/-20	0.1	-	-	-	7	4	-	-	-	
		SSM6N15FU ●	\$	30	+/-20	0.1	-	-	-	7	4	-	-	-	⇒ SSM6N15AFU
		SSM6N15AFU	\$	30	+/-20	0.1	-	-	-	6	3.6	-	-	-	
		SSM6N79FU ☆	\$	30	+/-20	0.1	-	-	-	6	3.6	-	-	-	Low leakage current
		SSM6N09FU	\$	30	+/-20	0.4	-	-	-	1.7 (@3.3V)	1.2	-	-	0.7	
		SSM6N17FU	\$	50	+/-7	0.1	-	-	-	40	20	-	-	-	
		SSM6N700CFU	\$	60	+/-20	0.17	-	-	-	-	-	4.7	4.4	3.9	
		SSM6N700KFU #	\$	60	+/-20	0.3	-	-	-	-	-	1.75	1.65	1.5	
		N-ch + P-ch	SSM6L35FU	\$	20	+/-10	0.18	20	8	-	4	3	-	-	-
\$	-20			+/-10	-0.1	44	22	-	11	8	-	-	-		
SSM6L09FU ●	\$		30	+/-20	0.4	-	-	-	1.7 (@3.3V)	1.2	-	-	0.7	⇒ SSM6L40TU	
		\$	-30	+/-20	-0.2	-	-	-	6 (@3.3V)	4.2	-	-	2.7		

☆ New Products

● Recommended Another New Product, # AEC-Q101 qualified, \$ With protection Zener diode between gate and source

# MOSFET with Diode

Package Dimensions (unit: mm)

ESV (SOT-553)	UFV (SOT-353F)	UDFN6 (SOT-1118)
		
1.6 x 1.6	2.0 x 2.1	2.0 x 2.0

Bottom View

Package	Polarity	Part Number	V <sub>oss</sub> (V)	V <sub>gss</sub> (V)	I <sub>D</sub> (A)	MOSFET								Diode				Note	
						R <sub>DS(ON)</sub> max (mΩ)								C <sub>iss</sub> typ. (pF)	V <sub>R</sub> (V)	I <sub>O</sub> (A)	V <sub>F</sub> max (V)		
						V <sub>GS</sub>   = 1.5 V	V <sub>GS</sub>   = 1.8 V	V <sub>GS</sub>   = 2.5 V	V <sub>GS</sub>   = 4 V	V <sub>GS</sub>   = 4.5 V	V <sub>GS</sub>   = 5 V	V <sub>GS</sub>   = 10 V	@I <sub>F</sub> (A)						
ESV	P-ch + SBD	SSM5G06FE	\$ -20	+/-10	-0.1	45000	-	12000	8000	-	-	-	11	12	0.1	0.5	0.1		
	N-ch + SBD	SSM5H06FE	\$ 20	+/-10	0.1	15000	-	4000	3000	-	-	-	9.3	12	0.1	0.5	0.1		
UFV	P-ch + SBD	SSM5G02TU	\$ -12	+/-12	-1	-	-	240	160	-	-	-	310	12	0.5	0.43	0.5		
		SSM5G09TU	\$ -12	+/-8	-1.5	-	-	200	130	-	-	-	550	12	0.5	0.43	0.5		
	N-ch + SBD	SSM5G11TU	\$ -30	+/-20	-1.4	-	-	-	403	-	-	226	120	30(¥)	0.7(¥¥)	0.44	0.7(¥¥)		
		N-ch + Switching Diode	SSM5H90ATU	\$ 20	+/-10	2.4	-	-	89	65	-	-	-	200	80	0.1	1.2	0.1	
UDFN6	P-ch + SBD	SSM6G18NU	\$ -20	+/-8	-2	261	185	143	-	112	-	-	270	30	1	0.58	1		
	N-ch + SBD	SSM6H19NU	\$ 40	+/-12	2	-	390	238	208 (@3.6V) 201 (@4.2V)	198	-	185 (@8V)	130	40	0.5	0.57	0.5		

\$ With protection Zener diode between gate and source, ¥ V<sub>RRM</sub>, ¥¥ I<sub>F(AV)</sub>

## ■ Part Naming Conventions

### Small-Signal MOSFET SSM / XSM Series

Ex.) SSM 3 K 329 — R  
 ① ② ③ ④ ⑤ ⑥

- |  |   |        |   |       |        |  |         |  |         |  |         |  |         |  |          |  |         |  |         |       |           |  |          |  |                                |  |            |  |           |  |            |  |         |  |            |  |         |  |  |  |         |  |  |  |                    |  |  |  |                 |  |  |        |   |  |  |        |                                |
|--|---|--------|---|-------|--------|--|---------|--|---------|--|---------|--|---------|--|----------|--|---------|--|---------|-------|-----------|--|----------|--|--------------------------------|--|------------|--|-----------|--|------------|--|---------|--|------------|--|---------|--|--|--|---------|--|--|--|--------------------|--|--|--|-----------------|--|--|--------|---|--|--|--------|--------------------------------|
| <p>① Small-Signal MOSFET<br/>         SSM : Initial of "Small-Signal MOSFET"<br/>         XSM : Initial of "Automotive Small-Signal MOSFET"</p> <p>② Pin count</p> <p>③ Polarity and internal configuration<br/>         K : N-channel, single<br/>         J : P-channel, single<br/>         N : N-channel, dual<br/>         P : P-channel, dual<br/>         L : N-channel and P-channel (dual)<br/>         E : N-channel and P-channel (pre-wired as a load switch)<br/>         H : N-channel and SBD (or Switching diode)<br/>         G : P-channel and SBD</p> | <p>④ Serial number of the products</p> <p>⑤ There may be a symbol that indicates chip change etc.</p> <p>⑥ Package</p> <table border="0"> <tr> <td>3-pin</td> <td>F: S-Mini</td> <td>5-pin</td> <td>F: SMV</td> </tr> <tr> <td></td> <td>FU: USM</td> <td></td> <td>FU: USV</td> </tr> <tr> <td></td> <td>FS: SSM</td> <td></td> <td>FE: ESV</td> </tr> <tr> <td></td> <td>FV: VESM</td> <td></td> <td>TU: UFV</td> </tr> <tr> <td></td> <td>TU: UFM</td> <td>6-pin</td> <td>G: WCSP6C</td> </tr> <tr> <td></td> <td>CT: CST3</td> <td></td> <td>L: Chip LGA<br/>(TCSP6A-172101)</td> </tr> <tr> <td></td> <td>CTB: CST3B</td> <td></td> <td>R: TSOP6F</td> </tr> <tr> <td></td> <td>CTC: CST3C</td> <td></td> <td>FU: US6</td> </tr> <tr> <td></td> <td>R: SOT-23F</td> <td></td> <td>FE: ES6</td> </tr> <tr> <td></td> <td></td> <td></td> <td>TU: UF6</td> </tr> <tr> <td></td> <td></td> <td></td> <td>NU: UDFN6 / UDFN6B</td> </tr> <tr> <td></td> <td></td> <td></td> <td>NW: DFN2020(WF)</td> </tr> <tr> <td></td> <td></td> <td>10-pin</td> <td>L: Chip LGA<br/>(TCSPAC-153001)<br/>(TCSPAG-341501)</td> </tr> <tr> <td></td> <td></td> <td>14-pin</td> <td>L: Chip LGA<br/>(TCSPED-302701)</td> </tr> </table> | 3-pin  | F: S-Mini   | 5-pin | F: SMV |  | FU: USM |  | FU: USV |  | FS: SSM |  | FE: ESV |  | FV: VESM |  | TU: UFV |  | TU: UFM | 6-pin | G: WCSP6C |  | CT: CST3 |  | L: Chip LGA<br>(TCSP6A-172101) |  | CTB: CST3B |  | R: TSOP6F |  | CTC: CST3C |  | FU: US6 |  | R: SOT-23F |  | FE: ES6 |  |  |  | TU: UF6 |  |  |  | NU: UDFN6 / UDFN6B |  |  |  | NW: DFN2020(WF) |  |  | 10-pin | L: Chip LGA<br>(TCSPAC-153001)<br>(TCSPAG-341501) |  |  | 14-pin | L: Chip LGA<br>(TCSPED-302701) |
| 3-pin  | F: S-Mini   | 5-pin  | F: SMV  |       |        |  |         |  |         |  |         |  |         |  |          |  |         |  |         |       |           |  |          |  |                                |  |            |  |           |  |            |  |         |  |            |  |         |  |  |  |         |  |  |  |                    |  |  |  |                 |  |  |        |   |  |  |        |                                |
|  | FU: USM   |        | FU: USV   |       |        |  |         |  |         |  |         |  |         |  |          |  |         |  |         |       |           |  |          |  |                                |  |            |  |           |  |            |  |         |  |            |  |         |  |  |  |         |  |  |  |                    |  |  |  |                 |  |  |        |   |  |  |        |                                |
|  | FS: SSM   |        | FE: ESV   |       |        |  |         |  |         |  |         |  |         |  |          |  |         |  |         |       |           |  |          |  |                                |  |            |  |           |  |            |  |         |  |            |  |         |  |  |  |         |  |  |  |                    |  |  |  |                 |  |  |        |   |  |  |        |                                |
|  | FV: VESM  |        | TU: UFV   |       |        |  |         |  |         |  |         |  |         |  |          |  |         |  |         |       |           |  |          |  |                                |  |            |  |           |  |            |  |         |  |            |  |         |  |  |  |         |  |  |  |                    |  |  |  |                 |  |  |        |   |  |  |        |                                |
|  | TU: UFM   | 6-pin  | G: WCSP6C   |       |        |  |         |  |         |  |         |  |         |  |          |  |         |  |         |       |           |  |          |  |                                |  |            |  |           |  |            |  |         |  |            |  |         |  |  |  |         |  |  |  |                    |  |  |  |                 |  |  |        |   |  |  |        |                                |
|  | CT: CST3  |        | L: Chip LGA<br>(TCSP6A-172101)                    |       |        |  |         |  |         |  |         |  |         |  |          |  |         |  |         |       |           |  |          |  |                                |  |            |  |           |  |            |  |         |  |            |  |         |  |  |  |         |  |  |  |                    |  |  |  |                 |  |  |        |   |  |  |        |                                |
|  | CTB: CST3B  |        | R: TSOP6F   |       |        |  |         |  |         |  |         |  |         |  |          |  |         |  |         |       |           |  |          |  |                                |  |            |  |           |  |            |  |         |  |            |  |         |  |  |  |         |  |  |  |                    |  |  |  |                 |  |  |        |   |  |  |        |                                |
|  | CTC: CST3C  |        | FU: US6   |       |        |  |         |  |         |  |         |  |         |  |          |  |         |  |         |       |           |  |          |  |                                |  |            |  |           |  |            |  |         |  |            |  |         |  |  |  |         |  |  |  |                    |  |  |  |                 |  |  |        |   |  |  |        |                                |
|  | R: SOT-23F  |        | FE: ES6   |       |        |  |         |  |         |  |         |  |         |  |          |  |         |  |         |       |           |  |          |  |                                |  |            |  |           |  |            |  |         |  |            |  |         |  |  |  |         |  |  |  |                    |  |  |  |                 |  |  |        |   |  |  |        |                                |
|  |   |        | TU: UF6   |       |        |  |         |  |         |  |         |  |         |  |          |  |         |  |         |       |           |  |          |  |                                |  |            |  |           |  |            |  |         |  |            |  |         |  |  |  |         |  |  |  |                    |  |  |  |                 |  |  |        |   |  |  |        |                                |
|  |   |        | NU: UDFN6 / UDFN6B                                |       |        |  |         |  |         |  |         |  |         |  |          |  |         |  |         |       |           |  |          |  |                                |  |            |  |           |  |            |  |         |  |            |  |         |  |  |  |         |  |  |  |                    |  |  |  |                 |  |  |        |   |  |  |        |                                |
|  |   |        | NW: DFN2020(WF)                                   |       |        |  |         |  |         |  |         |  |         |  |          |  |         |  |         |       |           |  |          |  |                                |  |            |  |           |  |            |  |         |  |            |  |         |  |  |  |         |  |  |  |                    |  |  |  |                 |  |  |        |   |  |  |        |                                |
|  |   | 10-pin | L: Chip LGA<br>(TCSPAC-153001)<br>(TCSPAG-341501) |       |        |  |         |  |         |  |         |  |         |  |          |  |         |  |         |       |           |  |          |  |                                |  |            |  |           |  |            |  |         |  |            |  |         |  |  |  |         |  |  |  |                    |  |  |  |                 |  |  |        |   |  |  |        |                                |
|  |   | 14-pin | L: Chip LGA<br>(TCSPED-302701)                    |       |        |  |         |  |         |  |         |  |         |  |          |  |         |  |         |       |           |  |          |  |                                |  |            |  |           |  |            |  |         |  |            |  |         |  |  |  |         |  |  |  |                    |  |  |  |                 |  |  |        |   |  |  |        |                                |

# 2. Bipolar Transistors















## ■ General-Purpose Transistors



















Package Dimensions (unit: mm)

Classification	$ V_{CE0} $ (V)	$ I_C $ (mA)	CST3 (SOT-883)		VESM (SOT-723)		SSM (SOT-416)	
			Bottom View					
			1.0 x 0.6		1.2 x 1.2		1.6 x 1.6	
Part Number								
			NPN	PNP	NPN	PNP	NPN	PNP
General Purpose	50	100	2SC6026CT	2SA2154CT				
	50	150			2SC6026MFV #	2SA2154MFV #	2SC4738 #	2SA1832 #

Classification	$ V_{CE0} $ (V)	$ I_C $ (mA)	USM (SOT-323)		UFM (SOT-323F)		S-Mini (SOT-346)		SOT23 (SOT-23)		SOT-23F			
			Part Number											
			NPN	PNP	NPN	PNP	NPN	PNP	NPN	PNP	NPN	PNP	NPN	PNP
General Purpose	30	500		2SA1588 #				2SA1182 #						
	50	150	2SC4116 #	2SA1586 #			2SC2712 #	2SA1162 #	TBC847	TBC857				
		200	TTC4116FU	TTA1586FU						TMBT3904	TMBT3906			
	50	500					2SC3325 #	2SA1313 #						
	45						TTC1949		TTA1713					
Low Noise	120	100	2SC4117 #	2SA1587 #			2SC2713 #	2SA1163 #						
Low Saturation	15	800						2SA1362 #						
Muting	20	300	2SC4213				2SC3326 #							
High Current	20	2500				2SA2215 #						TTA502 # ☆		
	25	800					2SC3265 #	2SA1298 #						
	50	1000			2SC6135 #						TTC500 # ☆	TTA500 # ☆		
	50	1700				2SA2195 #								
	50	2000										TTA501 # ☆		
	50	2500			2SC6100 #							TTC501 # ☆		
High Breakdown	300	100										TTC502 # ☆		
								2SA1721						

☆ New Products  
# AEC-Q101 qualified

Classification	$ V_{CE0} $ (V)	$ I_c $ (mA)	ESV (SOT-553)	USV (SOT-353)	SMV (SOT-25)			
			 1.6 x 1.6	 2.0 x 2.1	 2.9 x 2.8			
			Part Number					
Complementary	NPN x 2	PNP x 2	NPN x 2	PNP x 2	Complementary			
General Purpose	50	150	HN4B01JE 	2SC4944 	2SA1873 	2SC4207 	2SA1618 	
					HN4A56JU 			
Low Noise	120	100			HN4C06J 	HN4A06J 	HN4B06J 	
					HN4C51J 	HN4A51J 		

Classification	$ V_{CE0} $ (V)	$ I_c $ (mA)	ES6 (SOT-563)			US6 (SOT-363)			SM6 (SOT-26)		
			 1.6 x 1.6			 2.0 x 2.1			 2.9 x 2.8		
			Part Number								
NPN x 2	PNP x 2	Complementary	NPN x 2	PNP x 2	Complementary	NPN x 2	PNP x 2	Complementary			
General Purpose	50	150	HN1C01FE # 	HN1A01FE # 		HN1C01FU # 	HN1A01FU # 	HN1B01FU # 	HN1C01F 	HN1A01F 	HN1B01F 
					HN1B04FE # 		HN1B04FU # 				
	50	500							HN1C07F 	HN1A07F 	
High Current	15	800								HN1A02F 	
Muting	20	300				HN1C03FU # 			HN1C03F 		

# AEC-Q101 qualified



## ■ Bipolar transistor with Diode

Package Dimensions (unit: mm)

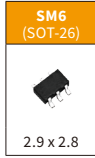

Package	Polarity	Part Number	$V_{CE0}$ (V)	$I_C$ (A)	PNP transistor			Switching Diode			Note	
					$h_{FE}$	$V_{CE(sat)}$ max (V)	$C_{ob}$ typ. (pF)	$V_R$ (V)	$I_O$ (A)	$V_F$ max (V)		
					$V_{CE} = -6$ V, $I_C = -2$ mA	$I_C = -10$ mA, $I_B = -1$ mA				@ $I_F$ (A)		
SM6	PNP + Switching Diode	HN2E04F	-120	-0.1	200 to 700	-0.3	4	80	0.1	1.2	0.1	

# Bias Resistor Built-in Transistors (BRTs)





Package Dimensions (unit: mm)

	$ V_{ce0} $ (V)	$ I_c $ (mA)	VESM (SOT-723)		SSM (SOT-416)		USM (SOT-323)		S-Mini (SOT-346)		
			Resistance		Resistance		Resistance		Resistance		
			R1 typ. (k $\Omega$ )	R2 typ. (k $\Omega$ )	NPN	PNP	NPN	PNP	NPN	PNP	NPN
			Part Number								
50	100	4.7	4.7	RN1101MVF#	RN2101MVF#	RN1101#	RN2101#	RN1301#	RN2301#	RN1401#	RN2401#
		10	10	RN1102MVF#	RN2102MVF#	RN1102#	RN2102#	RN1302#	RN2302#	RN1402#	RN2402#
		22	22	RN1103MVF#	RN2103MVF#	RN1103#	RN2103#	RN1303#	RN2303#	RN1403#	RN2403#
		47	47	RN1104MVF#	RN2104MVF#	RN1104#	RN2104#	RN1304#	RN2304#	RN1404#	RN2404#
		2.2	47	RN1105MVF#	RN2105MVF#	RN1105#	RN2105#	RN1305#	RN2305#	RN1405#	RN2405#
		4.7	47	RN1106MVF#	RN2106MVF#	RN1106#	RN2106#	RN1306#	RN2306#	RN1406#	RN2406#
		10	47	RN1107MVF#	RN2107MVF#	RN1107#	RN2107#	RN1307#	RN2307#	RN1407#	RN2407#
		22	47	RN1108MVF#	RN2108MVF#	RN1108#	RN2108#	RN1308#	RN2308#	RN1408#	RN2408#
		47	22	RN1109MVF#	RN2109MVF#	RN1109#	RN2109#	RN1309#	RN2309#	RN1409#	RN2409#
		4.7	-	RN1110MVF#	RN2110MVF#	RN1110#	RN2110#	RN1310#	RN2310#	RN1410#	RN2410#
		10	-	RN1111MVF#	RN2111MVF#	RN1111#	RN2111#	RN1311#	RN2311#	RN1411#	RN2411#
		22	-	RN1112MVF#	RN2112MVF#	RN1112#	RN2112#	RN1312#	RN2312#	RN1412#	RN2412#
		47	-	RN1113MVF#	RN2113MVF#	RN1113#	RN2113#	RN1313#	RN2313#	RN1413#	RN2413#
		1	10	RN1114MVF#	RN2114MVF#	RN1114	RN2114	RN1314	-	RN1414	RN2414
		2.2	10	RN1115MVF#	RN2115MVF#	RN1115#	RN2115#	RN1315#	RN2315#	RN1415#	RN2415#
		4.7	10	RN1116MVF#	RN2116MVF#	RN1116#	RN2116#	RN1316#	RN2316#	RN1416#	RN2416#
		10	4.7	RN1117MVF#	RN2117MVF#	RN1117	RN2117	RN1317	RN2317#	RN1417#	RN2417#
		47	10	RN1118MVF#	-	RN1118	-	RN1318	RN2318	RN1418#	RN2418#
		1	-	RN1119MVF#	RN2119MVF#	-	-	-	-	-	-
		100	100	RN1130MVF#	RN2130MVF#	-	-	-	-	-	-
100	-	RN1131MVF#	RN2131MVF#	-	-	-	-	-	-		
200	-	RN1132MVF#	RN2132MVF#	-	-	-	-	-	-		

	$ V_{ce0} $ (V)	$ I_c $ (mA)	SOT23 (SOT-23)		
			Resistance		
			R1 typ. (k $\Omega$ )	R2 typ. (k $\Omega$ )	
				Part Number	
50	100	4.7	4.7	TDTC143E	TDTA143E
		10	10	TDTC144E	TDTA144E
		22	22	TDTC124E	TDTA124E
		47	47	TDTC144E	TDTA144E
		2.2	47	TDTC123J	TDTA123J
		4.7	47	TDTC143Z	TDTA143Z
		10	47	TDTC114Y	TDTA114Y

	$ V_{ce0} $ (V)	$ I_c $ (mA)	S-Mini (SOT-346)			
			Resistance			
			R1 typ. (k $\Omega$ )	R2 typ. (k $\Omega$ )	NPN	PNP
				Part Number		
50	800	1	1	RN1421	RN2421	
		2.2	2.2	RN1422	RN2422	
		4.7	4.7	RN1423	RN2423	
		10	10	RN1424	RN2424	
		0.47	10	RN1425	RN2425	
		1	10	RN1426	RN2426	
		2.2	10	RN1427	RN2427	

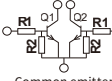
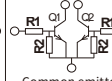
# AEC-Q101 qualified

V <sub>ce(sat)</sub> (V)	I <sub>c</sub> (mA)	Resistance		ESV (SOT-553)		USV (SOT-353)		SMV (SOT-25)	
				 1.6 x 1.6		 2.0 x 2.1		 2.9 x 2.8	
				 Common emitter		 Common emitter		 Common emitter	
				R1 typ. (kΩ)	R2 typ. (kΩ)	NPN x 2	PNP x 2	NPN x 2	PNP x 2
Part Number									
50	100	4.7	4.7	RN1701JE	RN2701JE	RN1701 #	RN2701 #	RN1501	RN2501
		10	10	RN1702JE	RN2702JE	RN1702 #	RN2702 #	RN1502	RN2502
		22	22	RN1703JE	RN2703JE	RN1703 #	RN2703 #	RN1503	RN2503
		47	47	RN1704JE	RN2704JE	RN1704 #	RN2704 #	RN1504	RN2504
		2.2	47	RN1705JE	RN2705JE	RN1705 #	RN2705 #	RN1505	RN2505
		4.7	47	RN1706JE	RN2706JE	RN1706 #	RN2706 #	RN1506	RN2506
		10	47	RN1707JE	RN2707JE	RN1707 #	RN2707 #	RN1507	RN2507
		22	47	RN1708JE	RN2708JE	RN1708 #	RN2708 #	RN1508	-
		47	22	RN1709JE	RN2709JE	RN1709 #	RN2709 #	RN1509	-
		4.7	-	RN1710JE	RN2710JE	RN1710 #	RN2710 #	RN1510	RN2510
		10	-	RN1711JE	RN2711JE	RN1711 #	RN2711 #	RN1511	RN2511
		22	-	-	RN2712JE	-	-	-	-
		47	-	-	RN2713JE	-	-	-	-

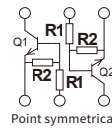
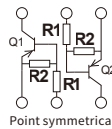
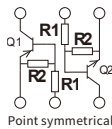
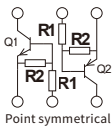
V <sub>ce(sat)</sub> (V)	I <sub>c</sub> (mA)	Resistance		ES6 (SOT-563)							
				 1.6 x 1.6							
				 Point symmetrical		 Point symmetrical		 Point symmetrical		 Point symmetrical	
				R1 typ. (kΩ)	R2 typ. (kΩ)	NPN x 2	PNP x 2	PNP + NPN	NPN + PNP		
Part Number											
50	100	4.7	4.7	RN1901FE #	RN2901FE #	RN4901FE #	RN4981FE #				
		10	10	RN1902FE #	RN2902FE #	RN4902FE #	RN4982FE #				
		22	22	RN1903FE #	RN2903FE #	RN4903FE #	RN4983FE #				
		47	47	RN1904FE #	RN2904FE #	RN4904FE #	RN4984FE #				
		2.2	47	RN1905FE #	RN2905FE #	RN4905FE #	RN4985FE #				
		4.7	47	RN1906FE #	RN2906FE #	RN4906FE #	RN4986FE #				
		10	47	RN1907FE #	RN2907FE #	RN4907FE #	RN4987FE #				
		22	47	RN1908FE #	RN2908FE #	RN4908FE #	RN4988FE #				
		47	22	RN1909FE #	RN2909FE #	RN4909FE #	RN4989FE #				
		4.7	-	RN1910FE #	RN2910FE #	RN4910FE #	RN4990FE #				
		10	-	RN1911FE #	RN2911FE #	RN4911FE #	RN4991FE #				

# AEC-Q101 qualified

V <sub>ce01</sub>   (V)		I <sub>c</sub>   (mA)		US6 (SOT-363)			
				 2.0 x 2.1			
				Resistance		Point symmetrical	
R1 typ. (kΩ)	R2 typ. (kΩ)	NPN x 2	PNP x 2	PNP + NPN	NPN + PNP		
Part Number							
50	100	4.7	4.7	RN1901 #	RN2901 #	RN4901 #	RN4981 #
		10	10	RN1902 #	RN2902 #	RN4902 #	RN4982 #
		22	22	RN1903 #	RN2903 #	RN4903 #	RN4983 #
		47	47	RN1904 #	RN2904 #	RN4904 #	RN4984 #
		2.2	47	RN1905 #	RN2905 #	RN4905 #	RN4985 #
		4.7	47	RN1906 #	RN2906 #	RN4906 #	RN4986 #
		10	47	RN1907 #	RN2907 #	RN4907 #	RN4987 #
		22	47	RN1908 #	RN2908 #	RN4908 #	RN4988 #
		47	22	RN1909 #	RN2909 #	RN4909 #	RN4989 #
		4.7	-	RN1910 #	RN2910 #	RN4910 #	RN4990
		10	-	RN1911 #	RN2911 #	RN4911 #	-
		47/2.2*	47	-	-	-	RN49A2



V <sub>ce01</sub>   (V)		I <sub>c</sub>   (mA)		SM6 (SOT-26)		
				 2.9 x 2.8		
				Resistance		Point symmetrical
R1 typ. (kΩ)	R2 typ. (kΩ)	NPN x 2	PNP x 2	PNP + NPN		
Part Number						
50	100	4.7	4.7	RN1601	RN2601	RN4601
		10	10	RN1602	RN2602	RN4602
		22	22	RN1603	RN2603	RN4603
		47	47	RN1604	RN2604	RN4604
		2.2	47	RN1605	RN2605	RN4605
		4.7	47	RN1606	RN2606	RN4606
		10	47	RN1607	RN2607	RN4607
		22	47	RN1608	RN2608	RN4608
		47	22	RN1609	-	RN4609
		4.7	-	RN1610	RN2610	RN4610
		10	-	RN1611	-	RN4611
		22	-	-	-	RN4612

\* Q1/Q2  
# AEC-Q101 qualified

# 3. Diodes

## ■ Schottky Barrier Diodes (SBDs)

Package Dimensions (unit: mm)

Features	Absolute Maximum Ratings		Electrical Characteristics (Ta = 25 °C)					CST2 (SOD-882)	CST2B	CST2C (SOD-963)	USC (SOD-323)	US2H (SOD-323HE)	UFV (SOT-353F)	
	V <sub>R</sub> / V <sub>RM</sub> * (V)	I <sub>O</sub> (A)	V <sub>F</sub>			I <sub>R</sub> max (μA)	C <sub>t</sub> typ. (pF)	Bottom View	Bottom View	Bottom View				
			typ. (V)	max (V)	@I <sub>F</sub> (A)			1.0 x 0.6	1.2 x 0.8	1.6 x 0.8	2.5 x 1.25	2.5 x 1.4	2.0 x 2.1	
High-V <sub>R</sub> and I <sub>O</sub>	60	2	0.52	0.59	2	70	60	300					CUHS20F60	
			0.46	0.53	2	650	60	290					CUHS20S60	
		1.5	0.66	0.73	1.5	50	60	130						CUHS15F60
			0.6	0.67	1.5	450	60	130						CUHS15S60
		1	0.56	0.62	1	40	60	130						CUHS10F60
														CUHS20F40
	40	2	0.47	0.54	2	60	40	300						CUHS20S40
			0.4	0.47	2	300	40	290						CUHS15S40
		1.5	0.45	0.51	1.5	200	40	170						CUHS15S40
			0.57	0.63	1.5	50	40	130						CUHS15F40
			0.59	0.64	1.5	25	40	130			CCS15F40			
		1	to 0.63	to 0.7	1	20	40	74		CBS10F40		CUS10F40		
	0.5	0.74	0.81	0.5	15	40	28	CTS05F40			CUS05F40			
	40*	1.5	0.47	0.55	1.5	200	40	170			CCS15S40	CUS15S40		
		1	to 0.48	to 0.55	1	150	40	120		CBS10S40		CUS10S40		
		0.5	0.56	0.6	0.5	50	40	42	CTS05S40			CUS05S40		
		2	0.4	0.47	2	60	30	380						CUHS20F30
			0.34	0.41	2	500	30	390						CUHS20S30
		1.5	0.46	0.52	1.5	50	30	170						CUHS15F30
	0.37		0.43	1.5	500	30	200						CUHS15S30	
	30	1	0.47	0.57	1	50	30	120						CVJ10F30
			0.43	0.5	1	50	30	170				CUS10F30		
		0.8	0.4	0.45	0.8	50	30	170				CUS08F30		
		0.5	0.38	0.45	0.5	50	30	to 120		CBS05F30		CUS05F30		
0.38			0.47	0.5	100	20	-				CUS551V30			
1.5		0.39	-	1.5	500	30	200			CCS15S30	CUS15S30			
30*	1	to 0.39	0.45	1	500	30	135		CBS10S30		CUS10S30			
	0.5	0.41	0.47	0.5	300	30	55	CTS05S30			CUS05S30			

① MOSFETS

② Tr./BJT's

③ Diodes

④ Power Management ICs

⑤ Linear ICs

⑥ Sensors





⑦ General Purpose Logic ICs





⑧ RF Devices





⑨ Packages

## ■ Schottky Barrier Diodes (SBDs)

Package Dimensions (unit: mm)

Features	Absolute Maximum Ratings		Electrical Characteristics (Ta = 25 °C)					CL2E	CST2 (SOD-882)	SOD-923	ESC (SOD-523)	USC (SOD-323)	
	V <sub>R</sub> (V)	I <sub>O</sub> (A)	V <sub>F</sub>			I <sub>R</sub> max (μA)		C <sub>t</sub> typ. (pF)	Bottom View	Bottom View			
			typ. (V)	max (V)	@I <sub>F</sub> (A)	@V <sub>R</sub> (V)							
Low-I <sub>R</sub> High-Speed	40	1	0.52	0.57	1	25	40	130					
	20	0.05	0.5	0.55	0.05	0.5	20	3.9		1SS413CT	1SS413	1SS405 #	1SS406 #



























Features	Absolute Maximum Ratings		Electrical Characteristics (Ta = 25 °C)					S-Mini (SOT-346)	US6 (SOT-363)	
	V <sub>R</sub> (V)	I <sub>O</sub> (A)	V <sub>F</sub>			I <sub>R</sub> max (μA)		C <sub>t</sub> typ. (pF)		
			typ. (V)	max (V)	@I <sub>F</sub> (A)	@V <sub>R</sub> (V)				
Low-I <sub>R</sub> High-Speed	20	0.05	0.5	0.55	0.05	0.5	20	3.9		
	10	0.05	0.63	1	0.05	0.5	10	3.2	1SS321 	HN2S03FU 







Features	Absolute Maximum Ratings		Electrical Characteristics (Ta = 25 °C)					SL2 (SOD-962)	CST2 (SOD-882)	SOD-923	ESC (SOD-523)	USC (SOD-323)	
	V <sub>R</sub> (V)	I <sub>O</sub> (A)	V <sub>F</sub>			I <sub>R</sub> max (μA)		C <sub>t</sub> typ. (pF)	Bottom View	Bottom View			
			typ. (V)	max (V)	@I <sub>F</sub> (A)	@V <sub>R</sub> (V)							
Standard	40	0.1	0.54	0.6	0.1	5	40	11					
			0.56	0.62	0.1	5	40	15		1SS417CT	1SS417	CES388 #	CUS357 #
	30	0.2	0.52	0.6	0.2	5	30	to 17		CTS520		CES520 #	CUS520 #
			0.45	0.5	0.2	30	30	to 26		CTS521		CES521	CUS521 #
		0.1	0.38	0.5	0.1	50	30	15		1SS416CT	1SS416		
			0.51	0.62	0.1	0.7	30	8.2	DSR01S30SL				
	20	0.41	0.5	0.1	50	30	9.3	DSF01S30SL					
		0.3	0.38	0.45	0.3	50	20	46					1SS404
	10	0.2	0.42	0.5	0.2	50	20	20				1SS424	
		0.1	0.35	0.5	0.1	20	10	20				1SS389 #	1SS367 #

# AEC-Q101 qualified

# ■ Schottky Barrier Diodes (SBDs)

Package Dimensions (unit: mm)

Features	Absolute Maximum Ratings		Electrical Characteristics (Ta = 25 °C)					VESM (SOT-723)	SSM (SOT-416)	USM (SOT-323)	S-Mini (SOT-346)	SOT23 (SOT-23)	
	V <sub>R</sub> (V)	I <sub>O</sub> (A)	V <sub>F</sub>			I <sub>R</sub> max (μA)	C <sub>T</sub> typ. (pF)						
			typ. (V)	max (V)	@I <sub>F</sub> (A)								@V <sub>R</sub> (V)
Standard	40	0.1	0.54	0.6	0.1	5	40	18			1SS322 	1SS294 	
			0.54	0.6	0.1	5	40	15			1SS393 	1SS392 	
			0.56	0.62	0.1	5	40	15		1SS423 		1SS396 # 	
	30	0.2	0.45	0.58	0.1	2	25	-					TBAT54 
													TBAT54C 
													TBAT54S 
													TBAT54A 
		0.1	0.38	0.5	0.1	50	30	15		1SS422 			
	20	0.3	0.38	0.45	0.3	50	20	46			1SS401 		
	10	0.1	0.35	0.5	0.1	20	10	20			1SS395 	1SS394 	
									1SS385FV 	1SS385 	1SS378 	1SS377 	
											1SS372 	1SS374 	

Features	Absolute Maximum Ratings		Electrical Characteristics (Ta = 25 °C)					ESV (SOT-553)	US6 (SOT-363)	SM6 (SOT-26)
	V <sub>R</sub> (V)	I <sub>O</sub> (A)	V <sub>F</sub>			I <sub>R</sub> max (μA)	C <sub>T</sub> typ. (pF)			
			typ. (V)	max (V)	@I <sub>F</sub> (A)					
Standard	40	0.1	0.54	0.6	0.1	5	40	18	HN2S02JE 	HN2S02FU 
	20	0.2	0.36	0.42	0.2	50	20	46		HN2S04FU 
	10	0.1	0.35	0.5	0.1	20	10	20		HN2S01FU 

# AEC-Q101 qualified

1 MOSFETs

2 Tr./BRTs

3 Diodes

4 Power Management ICs

5 Linear ICs

6 Sensors















7 General Purpose Logic ICs

8 RF Devices

9 Packages

# Switching Diodes

Package Dimensions (unit: mm)

























Absolute Maximum Ratings		Electrical Characteristics (Ta = 25 °C)		CST2 (SOD-882)	SOD-923	ESC (SOD-523)	USC (SOD-323)	CST3 (SOT-883)	VESM (SOT-723)	SSM (SOT-416)	USM (SOT-323)	SOT23 (SOT-23)	
V <sub>R</sub> (V)	I <sub>o</sub> (mA)	C <sub>t</sub> typ. (pF)	t <sub>rr</sub> typ. (ns)	Bottom View		Bottom View		Bottom View		Bottom View		Bottom View	
													
80	80	0.5	1.6										
		0.3	1.6		1SS427								
	0.5	1.6	1SS387CT		1SS387 #	1SS352 #							
	100	0.9	1.6					1SS361CT	1SS361FV #	1SS361 #	1SS301 #		
			1.6										
		-						1SS362FV #		1SS302A #			
2	-				1SS307E #								
2.2	1.6								1SS360 #	1SS300 #			
215	0.9	1.6										TBAS16	
												TBAW56	
100	150	0.9	4 (max)								BAV99W		
			4 (max)									BAV70	
	215	0.9	3 (max)									BAV99	
			0.35	3 (max)		BAS516	BAS316						
0.5	3 (max)		1N4148WT* #	1N4148WS* #									
200	100	1.5	10				1SS403 #				1SS370		
			60 (max)			1SS403E							
400	100	2.5	0.5								1SS397		

# AEC-Q101 qualified  
 ☆ New Products



# Switching Diodes





Package Dimensions (unit: mm)

Absolute Maximum Ratings		Electrical Characteristics (Ta = 25 °C)		S-Mini (SOT-346)	ESV (SOT-553)	USV (SOT-353)	SMV (SOT-25)	ES6 (SOT-563)	US6 (SOT-363)	SM6 (SOT-26)	
V <sub>r</sub> (V)	I <sub>o</sub> (mA)	C <sub>t</sub> typ. (pF)	t <sub>rr</sub> (ns)								
30	100	3	-	1SS307 							
80	100	0.5	1.6						HN2D01FU # 	HN2D01F 	
										HN2D02FU # 	
	100	0.5	1.6		HN2D01JE 						
	100	0.9	1.6		1SS184 # 	HN4D02JU 	1SS309 				
								HN1D02FE 	HN1D02FU # 	HN1D02F 	
			2.2	1.6							
		3	-								
			Q1/2=0.9 Q3/4=2.2	1.6						HN1D03FU # 	HN1D03F 
	200	100	1.5	10	1SS250 						
400	100	2.5	0.5	1SS398 						HN2D03F 	
		4.3	0.5					HN1D05FE ☆ 			

☆ New Products  
# AEC-Q101 qualified

# TVS Diodes (ESD Protection Diodes)

Package Dimensions (unit: mm)

Application		Absolute Maximum Ratings		Electrical Characteristics (Ta = 25 °C)			SL2 (SOD-962)	CST2 (SOD-882)	SOD-923	ESC (SOD-523)
							Bottom View	Bottom View		
									1.0 x 0.6	1.6 x 0.8
		V <sub>ESD</sub> IEC61000 -4/2 (kV)	I <sub>PP</sub> tp = 8/20 μs (A)	V <sub>RWM</sub> max (V)	C <sub>t</sub> typ. (pF)	R <sub>OHV</sub> typ. (Ω)	0.62 x 0.32	1.0 x 0.6	1.0 x 0.6	1.6 x 0.8
Bi-directional	USB3.1/ Thunderbolt™/ RF antenna	±20	2.5	3.3	0.3	0.5	DF2B5M5SL	DF2B5M5CT		
		±20	2.5	5	0.3	0.5	DF2B6M5SL	DF2B6M5CT		
		±20	2	3.6	0.2	0.5 to 0.8	DF2B5M4SL	DF2B5M4CT		
		±20	2	5.5	0.2	0.5 to 0.8	DF2B6M4SL	DF2B6M4CT		
		±16	2	3.6	0.15	0.7	DF2B5M4ASL			
		±15	2	5.5	0.15	0.7	DF2B6M4ASL			
		±15	1	11	0.2	0.65	DF2B12M4SL			
		±15	0.5	18.5	0.2	0.2	DF2B20M4SL			
		±15	0.5	24	0.2	0.2	DF2B26M4SL			
		±12	2.5	5.5	0.1	0.7	DF2B7M3SL			
		±12	2	5	0.2	1	DF2B7M2SL ●			
	±12	2.5	5	0.3	0.8		DF2B6.8M1ACT			
	±8	2	5.5	0.12	0.7	DF2B6M4BSL				
	USB2.0	±10	1.5	5.5	1.5	0.25	DF2B6USL			
	General Purpose / Audio / SIM Card	±30	27	5.5	45	0.1		DF2B7PCT		
±30		4	5.5	8.5	0.2	DF2B7ASL	DF2B7ACT	DF2B7AFS	DF2B7AE	
±30		7.3	5.5	12	0.2	DF2B7BSL				
±30		27	3.6	41	0.1		DF2B5PCT			
±23		8	3.3	11	0.2	DF2B5BSL				
±17		3	5.3	6	0.3	DF2B7SL				
±17		5.5	3.3	7.2	0.25	DF2B5SL				
±8		-	5	15	-				DF2B6.8E #	
Uni-directional	USB3.1/ Thunderbolt™/ RF antenna (NFC)	±20	2	3.6	0.35 to 0.45	0.3 to 0.35	DF2S5M4SL	DF2S5M4CT	DF2S5M4FS ☆	
		±20	2	5.5	0.35 to 0.45	0.3 to 0.35	DF2S6M4SL	DF2S6M4CT	DF2S6M4FS ☆	
		±20	2.5	3.3	0.6	0.3	DF2S5M5SL	DF2S5M5CT		
		±20	2.5	5	0.6	0.3	DF2S6M5SL	DF2S6M5CT		
	USB2.0	±12	3	5	to 0.5	0.35	DF2S7MSL ●		DF2S6.8MFS	
	General Purpose / Audio / SIM Card	±30	2.5	1.5	45	0.2	DF2S5.1ASL			
		±30	2.5	3.5	40	0.25	DF2S5.6ASL			
		±30	2.5	5	32	0.3	DF2S6.2ASL			
		±30	2.5	5	25	0.5	DF2S6.8ASL			
		±30	2.5	6.5	20	0.8	DF2S8.2ASL			
		±30	2.5	8	16	0.5	DF2S10ASL ☆			
		±20	2.5	9	13	1.5	DF2S12ASL ☆			
		±12	2.5	12	10	0.6	DF2S16ASL			
		±12	2.5	15	9.5	1.25	DF2S20ASL ☆			
		±10	2.5	19	8.5	1.5	DF2S24ASL ☆			
±8		2.5	23	7.5	4	DF2S30ASL ☆				

Thunderbolt™ is a trademark of Intel Corporation or its subsidiaries.







☆ New Products, # AEC-Q101 qualified





● Recommended Another New Product

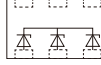





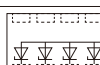

DF2S7MSL → DF2S6M5SL, DF2B7M2SL → DF2B6M4SL

# TVS Diodes (ESD Protection Diodes)

Package Dimensions (unit: mm)

Application		Absolute Maximum Ratings		Electrical Characteristics (Ta = 25 °C)			DFN5	DFN6	DFN10
							Bottom View	Bottom View	Bottom View
							 1.3 x 0.8	 1.25 x 1.0	 2.5 x 1.0
		V <sub>ESD</sub> IEC61000 -4.2 (kV)	I <sub>PP</sub> tp = 8 / 20 μs (A)	V <sub>RWM</sub> max (V)	C <sub>t</sub> typ. (pF)	R <sub>DYN</sub> typ. (Ω)	 G	 G	 G
Bi-directional	USB3.1 / Thunderbolt™ / RF antenna	±20	2	3.6	0.2	0.5 to 0.8	DF5G5M4N	DF6D5M4N	DF10G5M4N
		±20	2	5.5	0.2	0.5 to 0.8	DF5G6M4N	DF6D6M4N	DF10G6M4N



Application		Absolute Maximum Ratings		Electrical Characteristics (Ta = 25 °C)			DFN5	DFN6	DFN10
							Bottom View	Bottom View	Bottom View
							 1.3 x 0.8	 1.25 x 1.0	 2.5 x 1.0
		V <sub>ESD</sub> IEC61000 -4.2 (kV)	I <sub>PP</sub> tp = 8 / 20 μs (A)	V <sub>RWM</sub> max (V)	C <sub>t</sub> typ. (pF)	R <sub>DYN</sub> typ. (Ω)	 G	 G	 G
Bi-directional	USB3.1 / Thunderbolt™ / RF antenna	±12	2.5	5.5	0.2	1	DF5G7M2N		
		±8	-	5	0.3	0.9		DF6D7M1N	
		±8	-	5	0.3	0.9			DF10G7M1N









Application		Absolute Maximum Ratings		Electrical Characteristics (Ta = 25 °C)			USC (SOD-323)	SSM (SOT-416)	USM (SOT-323)	UDFN6B (SOT-1220)
							 2.5 x 1.25	 1.6 x 1.6	 2.0 x 2.1	 2.0 x 2.0
										
Bi-directional	General Purpose / Audio / SIM Card	±30	4	5.5	8.5	0.2	DF2B7AFU			
	Automotive's CAN/LIN	±30	2.5	12	9	0.8	DF2B18FU #	DF3D18FU #		
		±25	3	24	9	1.1	DF2B29FU #	DF3D29FU #		
		±20	2.5	28	6.5	1.5	DF2B36FU #	DF3D36FU #		
Uni-directional	USB2.0	±8	-	5	0.5	-		DF3D6.8MS		
	Power Supply USB_V <sub>BUS</sub>	±30	80	5.5	600	0.08	DF2S6P2FU			
		±30	60	10	280	0.08	DF2S12P2FU			
		±30	50	12.6	270	0.08	DF2S14P2FU			
		±30	14	21	160	0.13	DF2S23P2FU			
		±30	110	22	-	0.01			DF6S25P3NU	

Thunderbolt™ is a trademark of Intel Corporation or its subsidiaries.  
# AEC-Q101 qualified

## ■ TVS Diodes (ESD Protection Diodes)

Package Dimensions (unit: mm)

Application	Absolute Maximum Ratings	Electrical Characteristics (Ta = 25 °C)			CST2 (SOD-882)	SOD-923	USC (SOD-323)
					Bottom View		
					1.0 x 0.6	1.0 x 0.6	2.5 x 1.25
	V <sub>ESD</sub> IEC61000 -4.2 (kV)	V <sub>Z</sub> min (V)	C <sub>T</sub> typ. (pF)	Z <sub>T</sub> max (Ω)			
Uni-directional  General-Purpose / SIM Card / Power-Supply	±30	4.8	45	70		DF2S5.1FS	
	±30	5.3	40	30	DF2S5.6CT	DF2S5.6FS	
	±30	5.8	32	30	DF2S6.2CT	DF2S6.2FS	
	±30	6.4	25	30	DF2S6.8CT	DF2S6.8FS	
	±30	7.7	20	30	DF2S8.2CT	DF2S8.2FS	
	±30	9.4	16	30		DF2S10FS	
	±20	11.4	15	10 (typ.)			DF2S12FU
	±20	11.4	15	25		DF2S12FS	
	±12	15.3	10	35	DF2S16CT	DF2S16FS	
	±12	18.8	9	to 55	DF2S20CT	DF2S20FS	
	±10	22.8	8.5	70		DF2S24FS	
	±8	28	7.2	75	DF2S30CT		
	±8	28	7	150		DF2S30FS	





Application	Absolute Maximum Ratings	Electrical Characteristics (Ta = 25 °C)			CST3 (SOT-883)	VESM (SOT-723)	USM (SOT-323)	S-Mini (SOT-346)	ESV (SOT-553)	USV (SOT-353)	SMV (SOT-25)	US6 (SOT-363)
					Bottom View							
					1.0 x 0.6	1.2 x 1.2	2.0 x 2.1	2.9 x 2.5	1.6 x 1.6	2.0 x 2.1	2.9 x 2.8	2.0 x 2.1
	V <sub>ESD</sub> IEC61000 -4.2 (kV)	V <sub>Z</sub> min (V)	C <sub>T</sub> typ. (pF)	Z <sub>T</sub> max (Ω)								
Uni-directional  General-Purpose / SIM Card / Power-Supply	±30	5.3	65	40		DF3A5.6FV#	DF3A5.6FU	DF3A5.6F	DF5A5.6JE	DF5A5.6FU	DF5A5.6F	
	±30	5.8	55	30		DF3A6.2FV#	DF3A6.2FU	DF3A6.2F	DF5A6.2JE	DF5A6.2FU	DF5A6.2F	
	±30	6.4	45	25	DF3A6.8CT	DF3A6.8FV#	DF3A6.8FU	DF3A6.8F	DF5A6.8JE	DF5A6.8FU	DF5A6.8F	DF6A6.8FU
	±30	5.3	29	40					DF5A5.6CJE	DF5A5.6CFU		
	±30	5.8	25	30					DF5A6.2CJE	DF5A6.2CFU		
	±25	6.4	23	25					DF5A6.8CJE	DF5A6.8CFU		
	±8	5.3	8	50			DF3A5.6LFU		DF5A5.6LJE	DF5A5.6LFU		
	±8	5.3	8	3 (typ.)		DF3A5.6LFV#						
	±8	5.9	6.5	50		DF3A6.2LFV#	DF3A6.2LFU		DF5A6.2LJE	DF5A6.2LFU		
	±8	6.5	to 6	50	DF3A6.8LCT	DF3A6.8LFV#	DF3A6.8LFU		DF5A6.8LJE	DF5A6.8LFU	DF5A6.8LF	

# AEC-Q101 qualified

# Zener Diodes for Over Voltage Protection

Package Dimensions (unit: mm)

## General type

Application	Electrical Characteristics (Ta = 25 °C)					ESC (SOD-523)	USC (SOD-323)	USM (SOT-323)	S-Mini (SOT-346)	SOT23 (SOT-23)
										
	Vz typ. (V)	Vz Range (V)	Iz (mA)	Ir max (μA)	Vr (V)	1.6 x 0.8 Po = 150 mW*	2.5 x 1.25 Po = 200 mW*	2.0 x 2.1 Po = 150 mW*	2.9 x 2.5 Po = 200 mW*	2.9 x 2.4 Po = 320 mW*
Uni-directional General-Purpose/ SIM Card / Power-Supply	5.6	5.3 to 6	5	1	3.5	CEZ5V6	CUZ5V6	MUZ5V6	MSZ5V6	MKZ5V6
	6.2	5.8 to 6.6	5	2.5	5	CEZ6V2	CUZ6V2	MUZ6V2	MSZ6V2	MKZ6V2
	6.8	6.4 to 7.2	5	1.5	5.5	CEZ6V8	CUZ6V8	MUZ6V8	MSZ6V8	MKZ6V8
	7.5	7 to 7.9	5	0.1	6	CEZ7V5 ☆	CUZ7V5 ☆	MUZ7V5 ☆	MSZ7V5 ☆	MKZ7V5 ☆
	8.2	7.7 to 8.7	5	0.1	7	CEZ8V2	CUZ8V2	MUZ8V2	MSZ8V2	MKZ8V2
	9.1	8.5 to 9.6	5	0.1	7.5	CEZ9V1 ☆	CUZ9V1 ☆	MUZ9V1 ☆	MSZ9V1 ☆	MKZ9V1 ☆
	10	9.4 to 10.6	5	0.1	8	CEZ10V ☆	CUZ10V ☆	MUZ10V ☆	MSZ10V ☆	MKZ10V ☆
	11	10.4 to 11.6	5	0.1	9	CEZ11V ☆	CUZ11V ☆	MUZ11V ☆	MSZ11V ☆	MKZ11V ☆
	12	11.4 to 12.6	5	0.1	10	CEZ12V	CUZ12V	MUZ12V	MSZ12V	MKZ12V
	13	12.4 to 14.1	5	0.1	11	CEZ13V ☆	CUZ13V ☆	MUZ13V ☆	MSZ13V ☆	MKZ13V ☆
	15	13.8 to 15.6	5	0.1	12	CEZ15V ☆	CUZ15V ☆	MUZ15V ☆	MSZ15V ☆	MKZ15V ☆
	16	15.3 to 17.1	5	0.1	14	CEZ16V	CUZ16V	MUZ16V	MSZ16V	MKZ16V
	18	16.8 to 19.1	5	0.1	16	CEZ18V ☆	CUZ18V ☆	MUZ18V ☆	MSZ18V ☆	MKZ18V ☆
	20	18.8 to 21.2	5	0.1	17.6	CEZ20V	CUZ20V	MUZ20V	MSZ20V	MKZ20V
	22	20.8 to 23.3	5	0.1	18	CEZ22V ☆	CUZ22V ☆	MUZ22V ☆	MSZ22V ☆	MKZ22V ☆
	24	22.8 to 25.6	5	0.1	19	CEZ24V	CUZ24V	MUZ24V	MSZ24V	MKZ24V
	27	25.1 to 28.9	2	0.1	23	CEZ27V ☆	CUZ27V ☆	MUZ27V ☆	MSZ27V ☆	MKZ27V ☆
	30	28 to 32	2	0.1	27	CEZ30V	CUZ30V	MUZ30V	MSZ30V	MKZ30V
	33	31 to 35	2	0.1	30	CEZ33V ☆	CUZ33V ☆	MUZ33V ☆	MSZ33V ☆	MKZ33V ☆
	36	34 to 38	2	0.1	32.5	CEZ36V	CUZ36V	MUZ36V	MSZ36V	MKZ36V

## General type (For Automotive)

Application	Electrical Characteristics (Ta = 25 °C)					USC
						
	Vz typ. (V)	Vz Range (V)	Iz (mA)	Ir max (μA)	Vr (V)	2.5 x 1.25 Po = 200 mW*
Uni-directional General-Purpose/ SIM Card / Power-Supply	5.6	5.3 to 6	5	1	2.5	XCUZ5V6 ☆ #
	6.2	5.8 to 6.6	5	1	3	XCUZ6V2 ☆ #
	6.8	6.4 to 7.2	5	0.5	3.5	XCUZ6V8 ☆ #
	7.5	7 to 7.9	5	0.5	4	XCUZ7V5 ☆ #
	8.2	7.7 to 8.7	5	0.1	5	XCUZ8V2 ☆ #
	9.1	8.5 to 9.6	5	0.1	6	XCUZ9V1 ☆ #
	10	9.4 to 10.6	5	0.1	7	XCUZ10V ☆ #
	11	10.4 to 11.6	5	0.1	8	XCUZ11V ☆ #
	12	11.4 to 12.6	5	0.1	9	XCUZ12V ☆ #
	13	12.4 to 14.1	5	0.1	10	XCUZ13V ☆ #
	15	13.8 to 15.6	5	0.1	11	XCUZ15V ☆ #
	16	15.3 to 17.1	5	0.1	12	XCUZ16V ☆ #
	18	16.8 to 19.1	5	0.1	13	XCUZ18V ☆ #
	20	18.8 to 21.2	5	0.1	15	XCUZ20V ☆ #
	22	20.8 to 23.3	5	0.1	17	XCUZ22V ☆ #
	24	22.8 to 25.6	5	0.1	19	XCUZ24V ☆ #
	27	25.1 to 28.9	2	0.1	21	XCUZ27V ☆ #
	30	28 to 32	2	0.1	23	XCUZ30V ☆ #
	33	31 to 35	2	0.1	25	XCUZ33V ☆ #
	36	34 to 38	2	0.1	27	XCUZ36V ☆ #

☆ New Products

\* Please refer to the data sheet for the conditions of the measurement board.

# AEC-Q101 qualified

## Power type

Application	Electrical Characteristics (Ta = 25 °C)					US2H (SOD-323HE)
						
						2.5 x 1.4 P <sub>D</sub> = 500 mW*
Uni-directional General-Purpose/ SIM Card / Power-Supply	V <sub>Z</sub> typ. (V)	V <sub>Z</sub> Range (V)	I <sub>Z</sub> (mA)	I <sub>R</sub> max (μA)	V <sub>R</sub> (V)	
	5.6	5.3 to 6	10	10	3.5	CUHZ5V6
	6.2	5.8 to 6.6	10	10	5	CUHZ6V2
	6.8	6.4 to 7.2	10	0.5	5.5	CUHZ6V8
	8.2	7.7 to 8.7	10	0.1	7	CUHZ8V2
	12	11.4 to 12.6	10	0.1	10	CUHZ12V
	16	15.3 to 17.1	10	0.1	14	CUHZ16V
	20	18.8 to 21.2	10	0.1	17.6	CUHZ20V
	24	22.8 to 25.6	10	0.1	19	CUHZ24V
	30	28 to 32	10	0.1	27	CUHZ30V
	36	34 to 38	9	0.1	32.5	CUHZ36V

## Ultra Small type

Application	Electrical Characteristics (Ta = 25 °C)					SL2 (SOD-962)
						Bottom View 
						0.62 x 0.32 P <sub>D</sub> = 150 mW*
Uni-directional General-Purpose/ SIM Card / Power-Supply	V <sub>Z</sub> typ. (V)	V <sub>Z</sub> Range (V)	I <sub>Z</sub> (mA)	I <sub>R</sub> max (μA)	V <sub>R</sub> (V)	
	5.6	5.3 to 6	5	1	3.5	CSLZ5V6 ☆
	6.2	5.8 to 6.6	5	2.5	5	CSLZ6V2 ☆
	6.8	6.4 to 7.2	5	0.5	5	CSLZ6V8 ☆
	8.2	7.7 to 8.7	5	0.5	6.5	CSLZ8V2 ☆
	10	9.4 to 10.6	5	0.5	8	CSLZ10V ☆
	12	11.4 to 12.6	5	0.5	9	CSLZ12V ☆
	16	15.3 to 17.1	5	0.5	12	CSLZ16V ☆
	20	18.8 to 21.2	5	0.5	15	CSLZ20V ☆
	24	22.8 to 25.6	5	0.5	19	CSLZ24V ☆
	30	28 to 31.5	2	0.5	23	CSLZ30V ☆

☆ New Products

\* Please refer to the data sheet for the conditions of the measurement board.

# Part Naming Conventions

## Diode (JEITA Registration Products)

**1 S S 181**

- Serial number**: JEITA registration number.
- The kind of diode**  
S: Diode of general-purpose use, detection use, frequency conversion use, and switching use  
V: Variable capacitance and PIN diode
- S stands for Semiconductor**
- The value that subtracted 1 from the total number of terminals**

## Schottky Barrier Diodes New Naming Conventions

**CU S 05 F 30 A**

- Revision or function category (A to Z)**
- Voltage rating**  
Ex.) 30: 30 V
- Device type**  
Ex.) S: Super Low forward voltage F: Low forward voltage, R: Low leakage current
- Current rating**  
Ex.) 05: 0.5 A
- Pin count**  
Ex.) S: 2pin
- Package**  
Ex.) CU: USC, CE: ESC, CB: CST2B, CE: CL2E

## Old Naming Conventions

**DS F 07 S 30 A U**

- Package style**: This letter shows the package style.
- Revision**
- Voltage rating**  
Ex.) 30: 30 V, 15: 15 V
- Circuit configuration and number of pins**
- Current rating**  
Ex.) 07: 0.7 A, 10: 1 A
- Device feature**: This letter shows the feature of a device.  
F: Low forward voltage type.  
R: Low leakage current type.
- Schottky barrier diode.**

## TVS Diodes (ESD Protection Diodes)

**DF 5 A 6.2 L FU**

- Package suffix**
- Series name**  
Ex.) L: Ultra-high-speed
- Reverse Breakdown Voltage ( $V_{BR}$ )**
- Internal configuration**  
Ex.) A: Common anode
- Pin count**
- TVS Diodes (ESD Protection Diodes)**

## Zener Diodes for Over Voltage Protection

**CU Z 6V8**











- Zener voltage**  
Ex.) 6V8: 6.8 V
- The kind of diode**  
Z: Zener Diode (uni-directional type)
- Package**  
CU: USC                      MS: S-Mini                      CSL: SL2  
CUH: US2H                MU: USM  
CE: ESC                      MK: SOT23

Note: The name of AEC-Q100 qualified product is XCUZxxx.

# 4. Power Management ICs

## ■ Low Dropout Regulators (LDO)

Package Dimensions (unit: mm)

WCSP4E	WCSP4F	SDFN4E	DFN4D	DFN4E	DFN4F	DFN5B	ESV (SOT-553)	UFV (SOT-353F)	SMV (SOT-25)	WCSP6F
Bottom View  0.645 x 0.645	Bottom View  0.645 x 0.645	Bottom View  0.8 x 0.8	Bottom View  1.0 x 1.0	Bottom View  1.0 x 1.0	Bottom View  1.0 x 1.0	Bottom View  1.2 x 1.2	 1.6 x 1.6	 2.0 x 2.1	 2.9 x 2.8	Bottom View  1.2 x 0.8

### CMOS LDO Regulators

Series Name / Part Number	Package	V <sub>OUT</sub> typ. (V)	V <sub>IN</sub> (V)	I <sub>OUT</sub> (mA)	I <sub>B</sub> typ. (μA)	Function							
						Over current protection	Auto discharge	Fast load transient response circuit	Thermal shutdown	Inrush current protection	Under voltage lockout	High PSRR	Control pin connection
TCR1HFxxB ☆	SMV	1.8 to 5	V <sub>OUT</sub> +1 to 36	150	1	✓	✓ (A version)	✓	✓	✓			Pull up
TCR2ENxxx	SDFN4E	1 to 3.6	1.5 to 5.5	200	35	✓	✓	✓					Pull down
TCR2LNxxx		0.8 to 3.6	1.5 to 5.5	200	1	✓	✓						Pull down
TCR2EExxx	ESV	1 to 5	1.5 to 5.5	200	35	✓	✓	✓					Pull down
TCR2LExxx		0.8 to 3.6	1.5 to 5.5	200	1	✓	✓						Pull down
TCR2EFxxx	SMV	1 to 5	1.5 to 5.5	200	35	✓	✓	✓					Pull down
TCR2LFxxx		0.8 to 3.6	1.5 to 5.5	200	1	✓	✓						Pull down
TCR3DGxxx	WCSP4E	1 to 4.5	1.75 to 5.5	300	65	✓	✓	✓	✓	✓			Pull down
TCR3LMxxxA ☆	DFN4D	0.8 to 5	1.4 to 5.5	300	1.2	✓	✓		✓				Pull down
TCR3DMxxxA ☆		1 to 4.5	1.5 to 5.5	300	86	✓	✓	✓	✓				Pull down
TCR3EMxxxA ☆	DFN4E	0.8 to 5	1.3 to 5.5	300	35	✓	✓		✓				Pull down
TCR3DMxxx		1 to 4.5	1.75 to 5.5	300	65	✓	✓	✓	✓	✓			Pull down
TCR3DFxxx	SMV	1 to 4.5	1.8 to 5.5	300	65	✓	✓	✓	✓	✓			Pull down
TCR3UGxxxA	WCSP4F	0.8 to 5	1.5 to 5.5	300	0.34	✓	✓	✓	✓	✓			Pull down
TCR3UGxxxB		1.5 to 5.5	300	0.34	✓	✓	✓	✓	✓				Pull down
TCR3UMxxxA	DFN4E	0.8 to 5	1.5 to 5.5	300	0.34	✓	✓	✓	✓	✓			Pull down
TCR3UFxxxA	SMV	0.8 to 5	1.5 to 5.5	300	0.34	✓	✓	✓	✓	✓			Pull down
TCR3UFxxxB		1.5 to 5.5	300	0.34	✓	✓	✓	✓	✓				Pull down
TCR3RMxxxA	DFN4F	0.9 to 4.5	1.8 to 5.5	300	7	✓	✓	✓	✓	✓		✓	Pull down
TCR4DGxxx	WCSP4E	1 to 4.5	V <sub>OUT</sub> +V <sub>D0</sub> to 5.5	420	65	✓	✓	✓	✓	✓			Pull down
TCR5RGxxxA	WCSP4F	0.9 to 5	1.8 to 5.5	500	7	✓	✓	✓	✓	✓		✓	Pull down
TCR5BMxxxA	DFN5B	0.8 to 3.6	V <sub>OUT</sub> +V <sub>D0</sub> to V <sub>BIAS</sub>	500	19	✓	✓	✓	✓	✓	✓	✓	Pull down
TCR8BMxxxA		0.8 to 3.6	V <sub>OUT</sub> +V <sub>D0</sub> to V <sub>BIAS</sub>	800	20	✓	✓	✓	✓	✓	✓	✓	Pull down
TCR13AGADJ	WCSP6F	0.55 to 3.6 adjustable	V <sub>OUT</sub> +0.1V to V <sub>BIAS</sub>	1300	56	✓	✓	✓	✓	✓	✓	✓	Pull down
TCR15AGxxx	WCSP6F	0.65 to 3.6	V <sub>OUT</sub> +V <sub>D0</sub> to V <sub>BIAS</sub>	1500	25	✓	✓	✓	✓	✓	✓	✓	Pull down
TCR15AGADJ	WCSP6F	0.6 to 3.6 adjustable	V <sub>OUT</sub> +V <sub>D0</sub> to V <sub>BIAS</sub>	1500	25	✓	✓	✓	✓	✓	✓	✓	Pull down

### Bipolar LDO Regulators

Series Name	Package	V <sub>OUT</sub> typ. (V)	V <sub>IN</sub> (V)	I <sub>OUT</sub> (mA)	I <sub>B</sub> typ. (μA)	Function				
						Over current protection	Auto discharge	Fast load transient response circuit	Thermal shutdown	Control pin connection
TAR5SxxU	UFV	1.5 to 5	2.4 to 15	200	170	✓			✓	
TAR5Sxx	SMV	1.5 to 5	2.4 to 15	200	170	✓			✓	
TAR5SBxx						✓			✓	

☆ New Products



# Load Switch ICs

Package Dimensions (unit: mm)

WCSP4D	WCSP4C	SMV (SOT-25)	WCSP6C	WCSP6E	DFN4A	WCSP4G
Bottom View  0.79 x 0.79	Bottom View  0.9 x 0.9	 2.9 x 2.8	Bottom View  1.5 x 1.0	Bottom View  1.2 x 0.8	Bottom View  1.2 x 1.2	Bottom View  0.645 x 0.645

Part Number	Package	Operating voltage range (V)	Output current (A)	R <sub>DS(on)</sub> (1) typ. (mΩ)	R <sub>DS(on)</sub> (2) typ. (mΩ)	Function						Note				
						Inrush current reduction (Slew Rate control)	Thermal shutdown	Over current protection	Auto discharge	Under voltage lockout	Reverse current block		Control pin connection (Active Level)			
TCK106AG	WCSP4D	1.1 to 5.5	1	176 @1.1V, -0.2A	34 @5V, -0.5A	✓						Pull down (H)				
TCK107AG						✓			✓		Pull down (H)					
TCK108AG						✓			✓		Open (L)					
TCK106AF	SMV	1.1 to 5.5	1	223 @1.1V, -0.2A	63 @5V, -0.5A	✓						Pull down (H)				
TCK107AF						✓			✓		Pull down (H)					
TCK108AF						✓			✓		Open (L)					
TCK111G ★	WCSP6C	1.1 to 5.5	3	8.5 @1.1V, -1.5A	8.3 @5V, -1.5A	✓	✓				True Reverse Current Blocking	Pull down (H)				
TCK112G ★						✓	✓		✓		Pull down (H)					
TCK126BG ☆	WCSP4G	1 to 5.5	1	343 @1V, -0.05A	46 @5V, -0.5A	✓						Pull down (H)	Ultra small Iq 0.08 nA			
TCK127BG ☆						✓			✓		Pull down (H)					
TCK128BG ☆						✓			✓		Open (L)					
TCK22921G	WCSP6E	1.1 to 5.5	2	136 @1.1V, -0.5A	25 @5V, -0.5A	4.5 μs			✓			✓	Pull down (H)			
TCK22922G						666 μs			✓		✓	Pull down (H)				
TCK22923G						1364 μs			✓		✓	Pull down (H)				
TCK22925G						3380 μs			✓		✓	Pull down (H)				
TCK22971G						4.5 μs			✓		✓	Pull down (H)				
TCK22972G						666 μs			✓		✓	Pull down (H)				
TCK22973G						1364 μs			✓		✓	Pull down (H)				
TCK22974G						3380 μs			✓		✓	Pull down (H)				
TCK22975G						666 μs			✓		✓	Open (L)				
TCK22910G						WCSP6E	1.1 to 5.5	2	179 @1.1V, -0.15A	31 @5V, -0.15A	1400 μs	✓			✓	
TCK22911G	1400 μs	✓		✓							Open (L)					
TCK22912G	1400 μs	✓		✓							✓	Pull down (H)				
TCK22913G	1400 μs	✓		✓							✓	Pull down (H)				
TCK22946G	WCSP6E	1.1 to 5.5	0.4	179 @1.1V, -0.15A	31 @5V, -0.15A	50 μs	✓	400 mA	✓	✓		True Reverse Current Blocking	Pull down (H)			
TCK22951G						0.74	50 μs	✓	740 mA	✓	✓	Pull down (H)				
TCK2065G		1.11	50 μs			✓	1110 mA	✓	✓	Pull down (H)						
TCK1024G		1.54	50 μs			✓	1540 mA	✓	✓	Pull down (H)						
TCK22891G		0.4	50 μs			✓	400 mA	✓		Pull down (H)						
TCK22892G		0.74	50 μs			✓	740 mA	✓		Pull down (H)						
TCK22893G		1.11	50 μs			✓	1110 mA	✓		Pull down (H)						
TCK22894G		1.54	50 μs			✓	1540 mA	✓		Pull down (H)						
TCK206G		WCSP4C	0.75 to 3.6			2	18.4 @0.75V, -1.5A	18.1 @3.3V, -1.5A	✓					✓	Pull down (H)	
TCK207G									✓			✓		Pull down (H)		
TCK208G	✓								✓		Open (L)					
TCK207AN	DFN4A			21.5 @0.75V, -1.5A	21.5 @3.3V, -1.5A	✓					✓	Pull down (H)				

☆ New Products

★ Under Development (The specification is subject to change without notice.)

# N-ch MOSFET Gate driver ICs with OVP function

Package Dimensions (unit: mm)

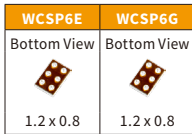

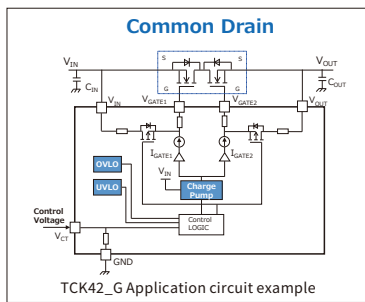
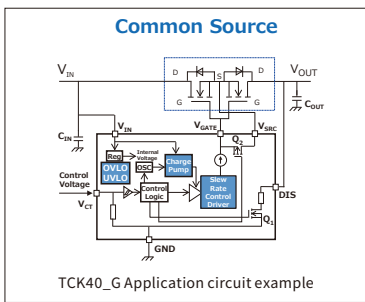

Part Number	Package	Operating voltage range (V)	Input quiescent current (ON state) @V <sub>IN</sub> =5V	Gate drive voltage (1) @V <sub>IN</sub> =3V	Gate drive voltage (2) @V <sub>IN</sub> =5V	Function					Note	
						Inrush current reduction	Under voltage lockout	Over voltage lock out (Typ.)	Auto discharge	Reverse current block		Control pin connection (Active Level)
TCK401G	WCSP6E	2.7 to 28	121 μA typ. @V <sub>IN</sub> =5V	4V typ. @V <sub>IN</sub> =3V	6.5V typ. @V <sub>IN</sub> =5V	✓	✓	✓ (28V)	✓	Option (with external Back to Back MOSFET)	Pull down (H)	For N-ch Common Source MOSFET or Single High Side MOSFET
TCK402G											Pull down (L)	
TCK420G ☆	WCSP6G	2.7 to 28	220 μA typ. @V <sub>IN</sub> =20V	9.2V typ. @V <sub>IN</sub> =2.7V	10V typ. @V <sub>IN</sub> =24V	✓	✓	✓ (27.73V)		Option (with external Back to Back MOSFET)	Pull down (H)	For N-ch Common Drain MOSFET or Single High Side MOSFET Recommended V <sub>IN</sub> =24V
TCK421G ☆	WCSP6G	2.7 to 28	220 μA typ. @V <sub>IN</sub> =20V	9.2V typ. @V <sub>IN</sub> =2.7V	10V typ. @V <sub>IN</sub> =20V	✓	✓	✓ (23.26V)		Option (with external Back to Back MOSFET)	Pull down (H)	For N-ch Common Drain MOSFET or Single High Side MOSFET Recommended V <sub>IN</sub> =20V
TCK422G ☆	WCSP6G	2.7 to 28	185 μA typ. @V <sub>IN</sub> =12V	9.2V typ. @V <sub>IN</sub> =2.7V	10V typ. @V <sub>IN</sub> =12V	✓	✓	✓ (14.29V)		Option (with external Back to Back MOSFET)	Pull down (H)	For N-ch Common Drain MOSFET or Single High Side MOSFET Recommended V <sub>IN</sub> =12V
TCK423G ☆	WCSP6G	2.7 to 28	140 μA typ. @V <sub>IN</sub> =12V	5.6V typ. @V <sub>IN</sub> =2.7V	5.6V typ. @V <sub>IN</sub> =12V	✓	✓	✓ (14.29V)		Option (with external Back to Back MOSFET)	Pull down (H)	For N-ch Common Drain MOSFET or Single High Side MOSFET Recommended V <sub>IN</sub> =12V
TCK424G ☆	WCSP6G	2.7 to 28	125 μA typ. @V <sub>IN</sub> =9V	5.6V typ. @V <sub>IN</sub> =2.7V	5.6V typ. @V <sub>IN</sub> =9V	✓	✓	✓ (10.83V)		Option (with external Back to Back MOSFET)	Pull down (H)	For N-ch Common Drain MOSFET or Single High Side MOSFET Recommended V <sub>IN</sub> =9V
TCK425G ☆	WCSP6G	2.7 to 28	100 μA typ. @V <sub>IN</sub> =5V	5.6V typ. @V <sub>IN</sub> =2.7V	5.6V typ. @V <sub>IN</sub> =5V	✓	✓	✓ (6.31V)		Option (with external Back to Back MOSFET)	Pull down (H)	For N-ch Common Drain MOSFET or Single High Side MOSFET Recommended V <sub>IN</sub> =5V



☆ New Products



## Power Multiplexer ICs

Package Dimensions (unit: mm)

WCSP9	WCSP16C
Bottom View  1.5 x 1.5	Bottom View  1.9 x 1.9

Part Number	Package	Operating voltage range (V)	Output current (A)	R <sub>DS(on)</sub> Typ. (mΩ) @Ta = 25 °C	R <sub>DS(on)</sub> max (mΩ) @Ta = -40 to 85 °C	Function						Flag Operation Monitored input	Note	
						Inrush current reduction	Thermal shutdown	Under voltage lockout	Over voltage lockout	Auto discharge	Reverse current block			Control pin connection (Active Level)
TCK301G	WCSP9	2.3 to 28	3	73 @4.5 V, -1 A	140 @4.5 V, -1 A	✓	✓	✓	6.6 V		✓	Pull up (H)	-	Single input Single output
TCK302G						✓	✓	✓	10.5 V		✓		-	
TCK303G						✓	✓	✓	15.5 V		✓		-	
TCK304G						✓	✓	✓	6.6 V		✓	Pull down (L)	-	
TCK305G						✓	✓	✓	10.5 V		✓		-	
TCK321G	WCSP16C	2.3 to 36	2	98 @4.5 V, -1 A	170 @4.5 V, -1 A	✓	✓	✓	V <sub>MAX</sub> = V <sub>VINB</sub> = 12 V		✓	V <sub>VINA</sub>	Dual input Single output	
TCK322G						✓	✓	✓	V <sub>MAX</sub> = V <sub>VINB</sub> = 15 V		✓	V <sub>VINA</sub>		
TCK323G						✓	✓	✓	V <sub>MAX</sub> = V <sub>VINB</sub> = 15 V		✓	V <sub>VINB</sub>		

## eFuse ICs

WSO10B	WSO10	WSO8
Bottom View  3.0 x 3.0	Bottom View  3.0 x 3.0	Bottom View  2.0 x 2.0

Part Number	Package	Operating voltage range (V)	Output current (A)	R <sub>DS(on)</sub> Typ. (mΩ) @Ta = 25 °C	R <sub>DS(on)</sub> max (mΩ) @Ta = -40 to 85 °C	Function							Note	
						Inrush current reduction	Thermal shutdown	Over voltage Clamp	Auto discharge	Under voltage lockout	Reverse current blocking	Fault Response		Over current protection
TCKE712BNL ☆	WSO10	4.4 to 13.2	3.65	53 @12 V, -1 A	80 @12 V, -1 A		✓	Adjustable		✓	✓	Latched	Adjustable	FLAG Indicates
TCKE805NA	WSO10B	4.4 to 18	5	28 @5 V, -1.5 A	38 @5 V, -1.5 A	Slew rate control by External Capacitance	✓	6.04 V typ.	✓	✓	*	Auto-retry	Adjustable	
TCKE805NL							✓	6.04 V typ.	✓	✓	*	Latched	Adjustable	
TCKE812NA							✓	15.1 V typ.	✓	✓	*	Auto-retry	Adjustable	
TCKE812NL							✓	15.1 V typ.	✓	✓	*	Latched	Adjustable	
TCKE800NA							✓	None	✓	✓	*	Auto-retry	Adjustable	
TCKE800NL							✓	None	✓	✓	*	Latched	Adjustable	
TCKE903NA ☆	WSO8	2.7 to 23	4	34 @5 V, -1.5 A	52 @5 V, -1.5 A Ta = -40 to 125 °C	Slew rate control by External Capacitance	✓	3.87 V typ.	✓	✓		Auto-retry	Adjustable	FLAG Indicates
TCKE903NL ☆							✓	3.87 V typ.	✓	✓		Latched	Adjustable	
TCKE905ANA ☆							✓	5.7 V typ.	✓	✓		Auto-retry	Adjustable	
TCKE905NL ☆							✓	5.7 V typ.	✓	✓		Latched	Adjustable	
TCKE912NA ☆							✓	13.7 V typ.	✓	✓		Auto-retry	Adjustable	
TCKE912NL ☆							✓	13.7 V typ.	✓	✓		Latched	Adjustable	
TCKE920NA ☆							✓	22.2 V typ.	✓	✓		Auto-retry	Adjustable	
TCKE920NL ☆							✓	22.2 V typ.	✓	✓		Latched	Adjustable	
TCKE903QNA ☆							✓	3.87 V typ.	✓ (Quick Discharge)	✓		Auto-retry	Adjustable	
TCKE905QNA ☆							✓	5.7 V typ.	✓ (Quick Discharge)	✓		Auto-retry	Adjustable	

☆ New Products

\* This function is supported when N-ch MOSFET is attached to the external terminal.

## 5. Linear ICs

### ■ Thermoflagger™ (Over Temperature Detection IC)

Package Dimensions (unit: mm)









	TCTH011AE ☆ Push-pull	TCTH012AE ☆ Push-pull	TCTH021AE ☆ Push-pull	TCTH022AE ☆ Push-pull	TCTH011BE ☆ Open-drain	TCTH012BE ☆ Open-drain	TCTH021BE ☆ Open-drain	TCTH022BE ☆ Open-drain
Package	ESV	ESV	ESV	ESV	ESV	ESV	ESV	ESV
Supply Voltage	1.7 to 5.5 V	1.7 to 5.5 V	1.7 to 5.5 V	1.7 to 5.5 V	1.7 to 5.5 V	1.7 to 5.5 V	1.7 to 5.5 V	1.7 to 5.5 V
Operation Temperature	-40 to 125 °C	-40 to 125 °C	-40 to 125 °C	-40 to 125 °C	-40 to 125 °C	-40 to 125 °C	-40 to 125 °C	-40 to 125 °C
PTCO output current (typ.)	1 μA	1 μA	10 μA	10 μA	1 μA	1 μA	10 μA	10 μA
FLAG signal latch function	-	included	-	included	-	included	-	included
Current Consumption (max)	2.6 μA	2.6 μA	16.5 μA	16.5 μA	2.6 μA	2.6 μA	16.5 μA	16.5 μA
High level output voltage @I <sub>PTCGOOD</sub> = -4 mA	3.03 V (min) @V <sub>DD</sub> = 3.3 V	3.03 V (min) @V <sub>DD</sub> = 3.3 V	3.03 V (min) @V <sub>DD</sub> = 3.3 V	3.03 V (min) @V <sub>DD</sub> = 3.3 V	-	-	-	-
Low level output voltage @I <sub>PTCGOOD</sub> = 4 mA	0.2 V (max) @V <sub>DD</sub> = 3.3 V	0.2 V (max) @V <sub>DD</sub> = 3.3 V	0.2 V (max) @V <sub>DD</sub> = 3.3 V	0.2 V (max) @V <sub>DD</sub> = 3.3 V	0.2 V (max) @V <sub>DD</sub> = 3.3 V	0.2 V (max) @V <sub>DD</sub> = 3.3 V	0.2 V (max) @V <sub>DD</sub> = 3.3 V	0.2 V (max) @V <sub>DD</sub> = 3.3 V

☆ New Products

“Thermoflagger™” is a trademark of Toshiba Electronic Devices & Storage Corporation.

# Operational Amplifiers, Comparators

Package Dimensions (unit: mm)

MP6C	USV (SOT-353)	UFV (SOT-353F)	SMV (SOT-25)	US8 (SOT-765)	SM8 (SOT-505)
Bottom View  1.45 x 1.0	 2.0 x 2.1	 2.0 x 2.1	 2.9 x 2.8	 2.0 x 3.1	 2.9 x 4.0

## Operational Amplifiers

Package	Type	Bipolar	
		Standard	Low Noise Wide Band
Single	SMV	TA75S01F	TA75S558F
Dual	SM8	TA75W01FU	TA75W558FU
V <sub>CC</sub> , V <sub>EE</sub> / V <sub>DD</sub> , V <sub>SS</sub>		±6 or 12 V	±18 V
Test condition		V <sub>CC</sub> = 5 V V <sub>EE</sub> = GND	V <sub>CC</sub> = 15 V V <sub>EE</sub> = -15 V
I <sub>CC</sub> / I <sub>DD</sub> (max)		0.8 mA @Single 1.2 mA @Dual	4 mA @Single 6 mA @Dual
V <sub>IO</sub> (max)		7 mV	6 mV
I <sub>sink</sub> (typ.)		20 mA	40 mA
I <sub>source</sub> (typ.)		40 mA	40 mA
G <sub>v</sub> (typ.)		100 dB	100 dB
V <sub>ni</sub> (typ.)			2.5 μVrms
SR (typ.)			1 V / μs
fr (typ.)		0.3 MHz	3 MHz

Package	Type	CMOS						
		Low Voltage Operation	Standard	Low I <sub>DD</sub>	Low I <sub>DD</sub> I/O Full range	Ultra Low I <sub>DD</sub> I/O Full range	Low Noise	Ultra Low Noise
Single	USV	TC75S51FU	TC75S54FU	TC75S55FU				
	UFV						TC75S63TU	TC75S67TU
	SMV	TC75S51F	TC75S54F	TC75S55F	TC75S103F ☆	TC75S102F ☆		
Dual	US8	TC75W51FK	TC75W54FK	TC75W55FK				
	SM8	TC75W51FU	TC75W54FU	TC75W55FU				
V <sub>CC</sub> , V <sub>EE</sub> / V <sub>DD</sub> , V <sub>SS</sub>		7 V	7 V	7 V	6 V	6 V	6 V	6 V
Test condition		V <sub>DD</sub> = 3 V	V <sub>DD</sub> = 3 V	V <sub>DD</sub> = 3 V	V <sub>DD</sub> = 3.3 V	V <sub>DD</sub> = 1.5 V	V <sub>DD</sub> = 3.3 V	V <sub>DD</sub> = 3.3 V
I <sub>CC</sub> / I <sub>DD</sub> (max)		200 μA @Single 400 μA @Dual	200 μA @Single 400 μA @Dual	20 μA @Single 40 μA @Dual	165 μA	0.46 μA	650 μA	700 μA
V <sub>IO</sub> (max)		10 mV	10 mV	10 mV	1.85 mV	1.3 mV	7 mV	3 mV
I <sub>sink</sub> (typ.)			700 μA	450 μA	10 mA	0.4 mA	1.5 mA (min)	3.5 mA
I <sub>source</sub> (typ.)			200 μA	20 μA	10 mA	0.6 mA	1.5 mA (min)	2.5 mA
G <sub>v</sub> (typ.)		70 dB	70 dB	70 dB	125 dB	139 dB	100 dB	100 dB
V <sub>ni</sub> (typ.)							7.8 nV / √Hz	6 nV / √Hz
SR (typ.)		0.5 V / μs	0.7 V / μs	0.08 V / μs	0.4 V / μs	0.37 V / ms	1 V / μs	1 V / μs
fr (typ.)		0.6 MHz	0.9 MHz	0.16 MHz	0.36 MHz	0.5 kHz	3.5 MHz	3.5 MHz

## Comparators



Package	Type	Bipolar	CMOS				
		Standard	Push pull		Open drain		
			Full-range input/output	Low I <sub>DD</sub>	High speed	Low I <sub>DD</sub>	High speed
Single	MP6C		TC75S70L6X				
	USV			TC75S56FU	TC75S57FU	TC75S58FU	TC75S59FU
	SMV	TA75S393F		TC75S56F	TC75S57F	TC75S58F	TC75S59F
Dual	US8			TC75W56FK	TC75W57FK	TC75W58FK	TC75W59FK
	SM8	TA75W393FU		TC75W56FU	TC75W57FU	TC75W58FU	TC75W59FU
V <sub>CC</sub> , V <sub>EE</sub> / V <sub>DD</sub> , V <sub>SS</sub>		±18 or 36 V	±3 or 6 V	±3.5 or 7 V	±3.5 or 7 V	±3.5 or 7 V	±3.5 or 7 V
Test condition		V <sub>CC</sub> = 5 V	V <sub>DD</sub> = 3 V	V <sub>DD</sub> = 5 V	V <sub>DD</sub> = 5 V	V <sub>DD</sub> = 5 V	V <sub>DD</sub> = 5 V
I <sub>CC</sub> / I <sub>DD</sub> (max)		0.8 mA @Single 2 mA @Dual	35 μA	22 μA @Single 44 μA @Dual	220 μA @Single 440 μA @Dual	22 μA @Single 44 μA @Dual	220 μA @Single 440 μA @Dual
I <sub>sink</sub> (typ.)		16 mA	18 mA	25 mA	25 mA	25 mA	25 mA
I <sub>source</sub> (typ.)			15 mA	21 mA	21 mA		
G <sub>v</sub> (typ.)		200 V / mV		94 dB	94 dB	94 dB	94 dB
t <sub>TRP</sub> , t <sub>PLH</sub> (typ.)		1.3 μs	400 ns	680 ns	140 ns	800 ns	200 ns

☆ New Products

# 6. Sensors

## Magnetic Sensors

Package Dimensions (unit: mm)

UFV (SOT-353F)	SOT-23F
 2.0 x 2.1	 2.9 x 2.4

		TCS40DPR	TCS40DLR	TCS30DPU	TCS30DLU	TCS30SPU	TCS30NPU
		Push pull	Open drain	Push pull	Open drain	Push pull	
Package		SOT-23F		UFV			
Detective Polarity		S&N		S&N	S	N	
Electrical Characteristics	Supply Voltage	2.3 to 5.5 V		2.3 to 3.6 V			
	Magnetic Flux Density	Operating Point ( $V_{CC} = 2.3$ to $3.6$ V)	$B_{ON} = 3.4$ mT (typ.)		$B_{ON} = 1.8$ mT (typ.)		
		Releasing Point ( $V_{CC} = 2.3$ to $3.6$ V)	$B_{OFF} = 2$ mT (typ.)		$B_{OFF} = 0.8$ mT (typ.)		
		Hysteresis ( $V_{CC} = 2.3$ to $5$ V)	$B_H = 1.4$ mT (typ.)		$B_H = 1$ mT (typ.)		
	Supply Current *	Average Current ( $V_{CC} = 2.3$ V)	7.3 $\mu$ A (typ.)		8.5 $\mu$ A (typ.)		
	Operating Frequency ( $V_{CC} = 2.3$ to $5$ V)	25 Hz (typ.)		25 Hz (typ.)			

\* Supply current is pulsed periodically by internal circuit.

1 MOSFETs

2 Tr./BRTs

3 Diodes

4 Power Management ICs

5 Linear ICs

6 Sensors

7 General Purpose Logic ICs

8 RF Devices

9 Packages





# 7. General Purpose Logic ICs

## 7-1 One-Gate Logic ICs (L-MOS)

Package Dimensions (unit: mm)

### VHS Series

General Specification	
Supply voltage range	: 2 to 5.5 V
Output current	: $\pm 8$ mA (@V <sub>CC</sub> = 4.5 V)
Propagation delay time	: 3.7 nsec typ. (@V <sub>CC</sub> = 5 V)
Quiescent supply current	: 2 $\mu$ A max (@V <sub>CC</sub> = 5.5 V, T <sub>a</sub> = 25 °C)
Operating temperature	: T <sub>opr</sub> = -40 to 125 °C







USV (SOT-353)	SMV (SOT-25)	US8 (SOT-765)	SM8 (SOT-505)
			
2.0 x 2.1	2.9 x 2.8	2.0 x 3.1	2.9 x 4.0

Function		Part Number						
		USV		SMV		US8	SM8	
		-	TTL Input	-	TTL Input			
Gate / Buffer	NAND	TC7SH00FU #	TC7SET00FU #	TC7SH00F	TC7SET00F	TC7WH00FK # Dual-gate	TC7WH00FU Dual-gate	
	AND		TC7SH08FU #	TC7SET08FU #	TC7SH08F	TC7SET08F	TC7WH08FK # Dual-gate	TC7WH08FU Dual-gate
		Open-drain	TC7SH09FU #		TC7SH09F			
	NOR	TC7SH02FU #	TC7SET02FU #	TC7SH02F	TC7SET02F	TC7WH02FK # Dual-gate	TC7WH02FU Dual-gate	
	OR	TC7SH32FU #	TC7SET32FU #	TC7SH32F	TC7SET32F	TC7WH32FK # Dual-gate	TC7WH32FU Dual-gate	
	Exclusive-OR	TC7SH86FU #		TC7SH86F				
	Inverter		TC7SH04FU #	TC7SET04FU #	TC7SH04F	TC7SET04F	TC7WH04FK # Triple-gate	TC7WH04FU Triple-gate
		Unbuffered	TC7SHU04FU #		TC7SHU04F		TC7WHU04FK # Triple-gate	TC7WHU04FU Triple-gate
		Schmitt	TC7SH14FU #	TC7SET14FU #	TC7SH14F	TC7SET14F	TC7WH14FK # Triple-gate	TC7WH14FU Triple-gate
	Buffer	Schmitt	TC7SH17FU #	TC7SET17FU #	TC7SH17F	TC7SET17F	TC7WH17FK # Triple-gate	TC7WH17FU Triple-gate
	Non-Inverter		TC7SH34FU #	TC7SET34FU #	TC7SH34F	TC7SET34F	TC7WH34FK # Triple-gate	TC7WH34FU Triple-gate
	3-state	Buffer	TC7SH125FU #	TC7SET125FU #	TC7SH125F	TC7SET125F	TC7WH125FK # Dual-gate	TC7WH125FU Dual-gate
TC7SH126FU #			TC7SET126FU #	TC7SH126F	TC7SET126F	TC7WH126FK # Dual-gate	TC7WH126FU Dual-gate	
D-Type Flip-Flop	Preset and Clear					TC7WH74FK #	TC7WH74FU	
Multiplexers	Digital					TC7WH157FK #	TC7WH157FU	

# This device is compliant with the reliability requirements of AEC-Q100

## SHS Series

General Specification	
Supply voltage range	: 1.65 to 5.5 V
Output current	: $\pm 24$ mA (@ $V_{CC} = 3$ V)
Propagation delay time	: 2.4 nsec typ. (@ $V_{CC} = 3.3$ V)
Quiescent supply current	: 1 $\mu$ A max (@ $V_{CC} = 5.5$ V, $T_a = 25$ °C)
Operating temperature	: $T_{opr} = -40$ to 125 °C

fsv (SOT-953)	ESV (SOT-553)	USV (SOT-353)	SMV (SOT-25)	US6 (SOT-363)	US8 (SOT-765)	SM8 (SOT-505)
						
1.0 x 1.0	1.6 x 1.6	2.0 x 2.1	2.9 x 2.8	2.0 x 2.1	2.0 x 3.1	2.9 x 4.0

Function		Part Number							
Package		fsv	ESV	USV	SMV	US6	US8	SM8	
Gate/ Buffer	NAND	TC7SZ00AFS	TC7SZ00FE	TC7SZ00FU #	TC7SZ00F		TC7WZ00FK # Dual-gate	TC7WZ00FU Dual-gate	
	AND	TC7SZ08AFS	TC7SZ08FE	TC7SZ08FU #	TC7SZ08F		TC7WZ08FK # Dual-gate	TC7WZ08FU Dual-gate	
	NOR	TC7SZ02AFS	TC7SZ02FE	TC7SZ02FU #	TC7SZ02F		TC7WZ02FK # Dual-gate	TC7WZ02FU Dual-gate	
	OR	TC7SZ32AFS	TC7SZ32FE	TC7SZ32FU #	TC7SZ32F		TC7WZ32FK # Dual-gate	TC7WZ32FU Dual-gate	
	Exclusive-OR	TC7SZ86AFS	TC7SZ86FE	TC7SZ86FU #	TC7SZ86F		TC7WZ86FK # Dual-gate	TC7WZ86FU Dual-gate	
	Inverter		TC7SZ04AFS	TC7SZ04FE	TC7SZ04FU #	TC7SZ04F	TC7PZ04FU # Dual-gate	TC7WZ04FK # Triple-gate	TC7WZ04FU Triple-gate
		Unbuffered	TC7SZU04AFS	TC7SZU04FE	TC7SZU04FU #	TC7SZU04F		TC7WZU04FK # Triple-gate	TC7WZU04FU Triple-gate
		Open-drain	TC7SZ05AFS	TC7SZ05FE	TC7SZ05FU #	TC7SZ05F	TC7PZ05FU # Dual-gate	TC7WZ05FK # Triple-gate	TC7WZ05FU Triple-gate
	Schmitt		TC7SZ14AFS	TC7SZ14FE	TC7SZ14FU #	TC7SZ14F	TC7PZ14FU # Dual-gate	TC7WZ14FK # Triple-gate	TC7WZ14FU Triple-gate
		Open-drain	TC7SZ07AFS	TC7SZ07FE	TC7SZ07FU #	TC7SZ07F	TC7PZ07FU # Dual-gate	TC7WZ07FK # Triple-gate	TC7WZ07FU Triple-gate
	Schmitt		TC7SZ17AFS	TC7SZ17FE	TC7SZ17FU #	TC7SZ17F	TC7PZ17FU # Dual-gate	TC7WZ17FK # Triple-gate	TC7WZ17FU Triple-gate
		Non-Inverter	TC7SZ34AFS	TC7SZ34FE	TC7SZ34FU #	TC7SZ34F	TC7PZ34FU # Dual-gate	TC7WZ34FK # Triple-gate	TC7WZ34FU Triple-gate
3-state Buffer		TC7SZ125AFS	TC7SZ125FE	TC7SZ125FU #	TC7SZ125F		TC7WZ125FK # Dual-gate	TC7WZ125FU Dual-gate	
		TC7SZ126AFS	TC7SZ126FE	TC7SZ126FU #	TC7SZ126F		TC7WZ126FK # Dual-gate	TC7WZ126FU Dual-gate	
D-Type Flip-Flop	Preset and Clear						TC7WZ74FK #	TC7WZ74FU	

# This device is compliant with the reliability requirements of AEC-Q100



## 7UL1Gxx Series





General Specification	
Supply voltage range	: 0.9 to 3.6 V
Output current	: $\pm 8$ mA (@ $V_{CC} = 3$ V)
Propagation delay time	: 2.5 nsec typ. (@ $V_{CC} = 3.3$ V)
Quiescent supply current	: 1 $\mu$ A max (@ $V_{CC} = 3.6$ V, $T_a = 25$ °C)
Operating temperature	: $T_{opr} = -40$ to 125 °C

fsv (SOT-953)	USV (SOT-353)	US8 (SOT-765)	XSON6 (MP6D)
			
1.0 x 1.0	2.0 x 2.1	2.0 x 3.1	Bottom View

Function		Part Number					
Package	fsv	USV	US8	XSON6 (MP6D)			
Gate / Buffer	NAND Gate	7UL1G00FS	7UL1G00FU	7UL2G00FK	7UL1G00NX ☆		
	NOR Gate	7UL1G02FS	7UL1G02FU	7UL2G02FK	7UL1G02NX ★		
	Inverter		7UL1G04FS	7UL1G04FU	7UL3G04FK	7UL1G04NX ☆	
		Unbuffered	7UL1GU04FS	7UL1GU04FU	7UL3GU04FK	7UL1GU04NX ☆	
	AND Gate	7UL1G08FS	7UL1G08FU	7UL2G08FK	7UL1G08NX ☆		
	Schmitt Inverter	7UL1G14FS	7UL1G14FU	7UL3G14FK	7UL1G14NX ☆		
	Schmitt Buffer	7UL1G17FS	7UL1G17FU	7UL3G17FK	7UL1G17NX ☆		
	OR Gate	7UL1G32FS	7UL1G32FU	7UL2G32FK	7UL1G32NX ☆		
	Buffer		7UL1G34FS	7UL1G34FU	7UL3G34FK	7UL1G34NX ☆	
		Open drain		7UL1G07FU			
	Exclusive-OR	7UL1G86FS	7UL1G86FU	7UL2G86FK	7UL1G86NX ★		
	3-State Buffer(/G)	7UL1G125FS	7UL1G125FU	7UL2G125FK	7UL1G125NX ☆		
3-State Buffer(G)	7UL1G126FS	7UL1G126FU	7UL2G126FK	7UL1G126NX ☆			

## 7UL1Txx Series

General Specification	
Supply voltage range	: 2.3 to 3.6 V
Output level up to supply $V_{CC}$ CMOS level	: 1.65 to 3.6 V (@ $V_{CC} = 3.6$ V)
Output level down to supply $V_{CC}$ CMOS level	: 3.6 to 2.3 V (@ $V_{CC} = 2.3$ V)
Quiescent supply current	: 1 $\mu$ A max (@ $V_{CC} = 3.6$ V, $T_a = 25$ °C)
Operating temperature	: $T_{opr} = -40$ to 125 °C

fsv (SOT-953)	USV (SOT-353)	US8 (SOT-765)	XSON6 (MP6D)
			
1.0 x 1.0	2.0 x 2.1	2.0 x 3.1	Bottom View

Function		Part Number				
Package	fsv	USV	US8	XSON6(MP6D)		
Gate / Buffer	NAND Gate	7UL1T00FS	7UL1T00FU	7UL2T00FK	7UL1T00NX ★	
	NOR Gate	7UL1T02FS	7UL1T02FU	7UL2T02FK	7UL1T02NX ★	
	Inverter	7UL1T04FS	7UL1T04FU	7UL3T04FK	7UL1T04NX ☆	
	AND Gate	7UL1T08FS	7UL1T08FU	7UL2T08FK	7UL1T08NX ★	
	OR Gate	7UL1T32FS	7UL1T32FU	7UL2T32FK	7UL1T32NX ★	
	Buffer	7UL1T34FS	7UL1T34FU	7UL3T34FK	7UL1T34NX ★	
	Exclusive-OR	7UL1T86FS	7UL1T86FU	7UL2T86FK	7UL1T86NX ★	
	3-State Buffer(/G)	7UL1T125FS	7UL1T125FU	7UL2T125FK	7UL1T125NX ★	
3-State Buffer(G)	7UL1T126FS	7UL1T126FU	7UL2T126FK	7UL1T126NX ★		



☆ New Products

★ Under Development (The specification is subject to change without notice.)

## 7-2 CMOS Logic ICs

### ■ Standard Logic 74VHC Series (TSSOP14B / 16B / 20B Package Products)

Package Dimensions (unit: mm)

TSSOP14B	TSSOP16B	TSSOP20B	Features
			<ul style="list-style-type: none"> <li>Available -40 to 125 °C products</li> <li>Compatible standard TSSOP package</li> </ul>
5.0 x 6.4	5.0 x 6.4	6.5 x 6.4	

Series name			VHC	VHCT (TTL Input)	VHCV (Schmitt Input)	VHC9 (Schmitt Input)		
Characteristics and Features	Supply voltage range		2 to 5.5 V	4.5 to 5.5 V	1.8 to 5.5 V	2 to 5.5 V 4.5 to 5.5 V (VHCT9)		
	Output current @V <sub>CC</sub> = 4.5 V		±8 mA		±16 mA	±8 mA		
	Power down protection on inputs		Yes					
	Power down protection on outputs		No	Yes				
Function			Pin					
Gate / Buffer	NAND	Quad	14	74VHC00FT	74VHCT00AFT			
		Open-drain	14	74VHC03FT				
			14	74VHC132FT				
			14	74VHC20FT				
	AND	Quad	14	74VHC08FT	74VHCT08AFT			
		Dual	4-input	14	74VHC21FT			
			14	74VHC02FT				
			14	74VHC27FT				
	NOR	Quad	14	74VHC32FT	74VHCT32AFT			
		Dual	4-input	14	74VHC27FT			
	OR	Quad	14	74VHC32FT	74VHCT32AFT			
		Exclusive-OR	Quad	14	74VHC86FT			
			14	74VHC04FT	74VHCT04AFT			
			14	74VHC05FT		74VHCV05FT		
	Inverter	Hex	14	74VHC14FT	74VHCT14AFT	74VHCV14FT		
			Open-drain	14	74VHC05FT		74VHCV05FT	
			Schmitt	14	74VHC14FT	74VHCT14AFT	74VHCV14FT	
		9-bit	20				74VHC9152FT	
	Buffer	Hex	14			74VHCV17FT		
			Open-drain	14			74VHCV07FT	
			Pull-down resistor	20				74VHC9363FT
		Dual 3-bit	Pull-up resistor	20				74VHC9364FT
			9-bit	20				74VHC9151FT
			3-state Buffer	Quad	14	74VHC125FT	74VHCT125AFT	
5-Bit Universal Schmitt Buffer	Quad	14	74VHC126FT	74VHCT126AFT				
		14				74VHC9125FT		
	Octal	Inverted	20	74VHC240FT	74VHCT240AFT	74VHCV240FT		
			20	74VHC540FT	74VHCT540AFT	74VHCV540FT		
			20	74VHC244FT	74VHCT244AFT	74VHCV244FT		
		Universal Schmitt Buffer	20	74VHC541FT	74VHCT541AFT	74VHCV541FT		
			20				74VHC9541FT	
			20				74VHC9541AFT	
	Transceiver	Octal	20	74VHC245FT	74VHCT245AFT	74VHCV245FT		
		Dual	14	74VHC74FT				
Hex		16	74VHC174FT					
Octal		20	74VHC273FT			74VHC9273FT		
3-state	Octal	20	74VHC374FT		74VHCV374FT			
		20	74VHC574FT	74VHCT574AFT	74VHCV574FT			
Latch	3-state	Octal	20	74VHC373FT	74VHCT373AFT	74VHCV373FT		
		20	74VHC573FT	74VHCT573AFT	74VHCV573FT			
		16	74VHC123AFT					
		16	74VHC221AFT					
Decoder	3 to 8 line	Single	16	74VHC138FT	74VHCT138AFT			
		16	74VHC238FT					
		Dual	16	74VHC139FT				
Shift Register	8bit	S-in / P-out	14	74VHC164FT				
		S-in / P-out, P-in / S-out	16			74VHC9164FT		
		P-in / S-out	16	74VHC165FT				
		3-state	16	74VHC595FT		74VHC9595FT		
Counter	Binary	Single 4bit with Async. Clear	16	74VHC161FT				
			16	74VHC163FT				
		Dual 4bit	14	74VHC393FT				
			14-stage	16	74VHC4020FT			
		Single	12-stage	16	74VHC4040FT			
			Dual-4ch.	16	74VHC153FT			
Multiplexer	Digital	Quad-2ch.	16	74VHC157FT				
		Single-8ch.	16	74VHC4051AFT				
		Dual-4ch.	16	74VHC4052AFT				
	Analog	Triple-2ch.	16	74VHC4053AFT				
		Quad	14	74VHC4066AFT				
		Other	Analog switch	14	74VHC4066AFT			

# Standard Logic TC74VHC Series (TSSOP14 / 16 / 20 Package Products)

Package Dimensions (unit: mm)

TSSOP14	TSSOP16	TSSOP20
		
5.0 x 6.4	5.0 x 6.4	6.5 x 6.4

## Features

- Compliant with the reliability requirements of AEC-Q100 Operating temperature: Available -40 to 125 °C products
- Compatible standard TSSOP package

Series name				VHC	VHCT (TTL Input)	VHCV (Schmitt Input)	VHC9 (Schmitt Input)		
<b>Characteristics and Features</b>				Supply voltage range	2 to 5.5 V	4.5 to 5.5 V	1.8 to 5.5 V		
				Output current @V <sub>CC</sub> = 4.5 V	±8 mA		±16 mA	±8 mA	
				Power down protection on inputs	Yes				
				Power down protection on outputs	No	Yes			
<b>Function</b>				<b>Pin</b>					
Gate / Buffer	NAND	Quad		14	TC74VHC00FT #	TC74VHCT00AFT #			
			Open-drain Schmitt	14	TC74VHC03FT #				
		Dual	4-input		14	TC74VHC132FT #			
					14	TC74VHC20FT #			
	AND	Quad		14	TC74VHC08FT #	TC74VHCT08AFT #			
		Dual	4-input	14	TC74VHC21FT #				
	NOR	Quad		14	TC74VHC02FT #				
		Dual	4-input	14	TC74VHC27FT #				
	OR	Quad		14	TC74VHC32FT #	TC74VHCT32AFT #			
	Exclusive-OR	Quad		14	TC74VHC86FT #				
				14	TC74VHC04FT #	TC74VHCT04AFT #			
	Inverter	Hex	Open-drain	14	TC74VHC05FT #		TC74VHCV05FT #		
			Schmitt	14	TC74VHC14FT #	TC74VHCT14AFT #	TC74VHCV14FT #		
		9-bit		20			TC74VHC9152FT #		
		Buffer	Hex		14			TC74VHCV17FT #	
	Open-drain			14			TC74VHCV07FT #		
	Dual 3-bit		Pull-down resistor	20				TC74VHC9363FT #	
			Pull-up resistor	20				TC74VHC9364FT #	
	3-state Buffer	Quad		14	TC74VHC125FT #	TC74VHCT125AFT #			
				14	TC74VHC126FT #	TC74VHCT126AFT #			
5-Bit Universal Schmitt Buffer			14				TC74VHC9125FT #		
			14				TC74VHC9125AFT #		
Octal		Inverted		20	TC74VHC240FT #	TC74VHCT240AFT #	TC74VHCV240FT #		
				20	TC74VHC540FT #	TC74VHCT540AFT #	TC74VHCV540FT #		
			20	TC74VHC244FT #	TC74VHCT244AFT #	TC74VHCV244FT #			
			20	TC74VHC541FT #	TC74VHCT541AFT #	TC74VHCV541FT #			
		Universal Schmitt Buffer		20				TC74VHC9541FT #	
				20				TC74VHCT9541AFT #	
Flip-Flop	Octal		20	TC74VHC245FT #	TC74VHCT245AFT #	TC74VHCV245FT #			
			14	TC74VHC74FT #					
			16	TC74VHC174FT #					
	3-state	Octal		20	TC74VHC273FT #		TC74VHC9273FT #		
			20	TC74VHC273FT #		TC74VHCT9273FT #			
Latch	3-state	Octal		20	TC74VHC374FT #	TC74VHCV374FT #			
				20	TC74VHC574FT #	TC74VHCT574AFT #	TC74VHCV574FT #		
Multi-vibrator	Dual		16	TC74VHC123AFT #		TC74VHCV123AFT #			
			16	TC74VHC221AFT #		TC74VHCV221AFT #			
Decoder	3 to 8 line	Single		16	TC74VHC138FT #	TC74VHCT138AFT #			
				16	TC74VHC238FT #				
	2 to 4 line	Dual		16	TC74VHC139FT #				
			16	TC74VHC164FT #					
Shift Register	8bit	S-in / P-out	14						
		S-in / P-out, P-in / S-out	16			TC74VHC9164FT #			
		P-in / S-out	16	TC74VHC165FT #					
		3-state	16	TC74VHC595FT #		TC74VHC9595FT #			
Counter	Binary	Single 4bit with	Async. Clear	16	TC74VHC161FT #				
			Sync. Clear	16	TC74VHC163FT #				
		Dual	4bit		14	TC74VHC393FT #			
					16	TC74VHC4020FT #			
		Single	12-stage	16	TC74VHC4040FT #				
Multiplexer	Digital	Dual-4ch.	16	TC74VHC153FT #					
		Quad-2ch.	16	TC74VHC157FT #					
	Analog	Single-8ch.	16	TC74VHC4051AFT #					
		Dual-4ch.	16	TC74VHC4052AFT #					
		Triple-2ch.	16	TC74VHC4053AFT #					
Other	Analog switch	Quad	14	TC74VHC4066AFT #					

# This device is compliant with the reliability requirements of AEC-Q100

1 MOSFETS

2 Tr./BJT's

3 Diodes

4 Power management ICs

5 Linear ICs

6 Sensors

7 General Purpose Logic ICs

8 RF Devices

9 Packages

# ■ Standard Logic 74HC Series, 74LCX Series (TSSOP14B / 16B / 20B Package Products)

Package Dimensions (unit: mm)

TSSOP14B	TSSOP16B	TSSOP20B
 5.0 x 6.4	 5.0 x 6.4	 6.5 x 6.4

Features
<b>74LCX Series</b> • Available -40 to 125 °C products (‡ Operation temperature of this device is -40 to 85 °C.) • Compatible standard TSSOP package
<b>74HC/HCT Series</b> • Available -40 to 125 °C products, Compatible standard TSSOP package

Series name				HC	HCT (TTL input)	LCX		
<b>Characteristics and Features</b>		Supply voltage range		2 to 6 V	4.5 to 5.5 V	1.65 to 3.6 V to 5.5 V (05 and 07)		
		Output current @V <sub>CC</sub> = 4.5 V		±4 or ±6 mA		±24 mA (@V <sub>CC</sub> = 3 V)		
		Power down protection on inputs		No		Yes		
		Power down protection on outputs		No		Yes		
		Function	Pin	-	-	-		
Gate / Buffer	NAND	Quad	14			74LCX00FT		
	AND	Quad	14			74LCX08FT		
	NOR	Quad	14			74LCX02FT		
	OR	Quad	14			74LCX32FT		
	Exclusive-OR	Quad	14			74LCX86FT		
	Inverter	Hex		14			74LCX04FT	
				16	TC74HC4049AFT &			
		Unbuffer		14	TC74HCU04AFT &			
		Open-drain		14			74LCX05FT	
	Schmitt		14			74LCX14FT		
	Buffer	Hex		16	TC74HC4050AFT &			
				Open-drain		14		
	3-state Buffer	Quad		14			74LCX125FT	
				14			74LCX126FT	
Octal		Inverted	20			74LCX240FT ‡		
			20			74LCX540FT ‡		
			20			74LCX244FT ‡		
		20			74LCX541FT ‡			
Transceiver	Octal	20			74LCX245FT ‡			
Flip-Flop		Dual	14			74LCX74FT		
		Octal	20			74LCX273FT		
	3-state	Octal	20			74LCX374FT ‡		
		20			74LCX574FT ‡			
Latch	3-state	Octal	20			74LCX373FT ‡		
			20			74LCX573FT ‡		
Multivibrator	Dual	Retriggerable / Resetttable	16	74HC4538FT				
Decoder	3 to 8 line	Single	16			74LCX138FT		
Multiplexer	Digital	Quad-2ch.	16			74LCX157FT		
			16			74LCX257FT		
	Analog	Single-8ch.	16	74HC4051FT	74HCT4051FT			
		Dual-4ch.	16	74HC4052FT	74HCT4052FT			
	Triple-2ch.	16	74HC4053FT	74HCT4053FT				
Other	Analog switch	Quad	14	74HC4066FT				

‡ Operation temperature is -40 to 85 °C  
& The package for this product is TSSOP14 / 16.

# Standard Logic TC74LCX Series (TSSOP14 / 16 / 20 Package Products)

Package Dimensions (unit: mm)

TSSOP14	TSSOP16	TSSOP20
		
5.0 x 6.4	5.0 x 6.4	6.5 x 6.4

## Features

- Compliant with the reliability requirements of AEC-Q100 Operating temperature: Available -40 to 125 °C products (‡ Operation temperature of this device is -40 to 85 °C.)
- Compatible standard TSSOP package

Series name				LCX		
<b>Characteristics and Features</b>		Supply voltage range		1.65 to 3.6 V to 5.5 V (05 and 07)		
		Output current @V <sub>CC</sub> = 4.5 V		±24 mA (@V <sub>CC</sub> = 3 V)		
		Power down protection on inputs		Yes		
		Power down protection on outputs		Yes		
<b>Function</b>			<b>Pin</b>			
Gate / Buffer	NAND	Quad	14	TC74LCX00FT #		
	AND	Quad	14	TC74LCX08FT #		
	NOR	Quad	14	TC74LCX02FT #		
	OR	Quad	14	TC74LCX32FT #		
	Exclusive-OR	Quad	14	TC74LCX86FT #		
	Inverter	Hex		14	TC74LCX04FT #	
			Open-drain	14	TC74LCX05FT #	
			Schmitt	14	TC74LCX14FT #	
	Buffer	Hex	Open-drain	14	TC74LCX07FT #	
	3-state Buffer	Quad		14	TC74LCX125FT #	
				14	TC74LCX126FT #	
		Octal	Inverted	20	TC74LCX240FT # ‡	
				20	TC74LCX540FT # ‡	
				20	TC74LCX244FT # ‡	
		20	TC74LCX541FT # ‡			
Transceiver	Octal		20	TC74LCX245FT # ‡		
Flip-Flop		Dual	14	TC74LCX74FT #		
		Octal	20	TC74LCX273FT #		
	3-state	Octal	20	TC74LCX374FT # ‡		
			20	TC74LCX574FT # ‡		
Latch	3-state	Octal	20	TC74LCX373FT # ‡		
			20	TC74LCX573FT # ‡		
Decoder	3 to 8 line	Single	16	TC74LCX138FT #		
Multi-plexer	Digital	Quad-2ch.	16	TC74LCX157FT #		
		3-state	16	TC74LCX257FT #		

# This device is compliant with the reliability requirements of AEC-Q100  
‡ Operation temperature is -40 to 85 °C

# ■ Standard Logic 74VHC Series (US14 / 16 / 20 Package Products)

Package Dimensions (unit: mm)



US14	US16	US20
		
4.0 x 4.0	4.0 x 4.0	5.0 x 4.0

Features
• Small mounting area and thin package

Series name			VHC	VHCT (TTL Input)	VHCV (Schmitt Input)	VHC9 (Schmitt Input)	
Characteristics and Features	Supply voltage range		2 to 5.5 V	4.5 to 5.5 V	1.8 to 5.5 V	2 to 5.5 V 4.5 to 5.5 V (VHCT9)	
	Output current @V <sub>CC</sub> = 4.5 V		±8 mA		±16 mA	±8 mA	
	Power down protection on inputs		Yes				
	Power down protection on outputs		No	Yes			
Function			Pin				
Gate / Buffer	NAND	Quad	14	TC74VHC00FK	TC74VHCT00AFK		
			Open-drain	14	TC74VHC03FK		
			Schmitt	14	TC74VHC132FK		
		Dual	4-input	14	TC74VHC20FK		
	AND	Quad	14	TC74VHC08FK	TC74VHCT08AFK		
		Dual	4-input	14	TC74VHC21FK		
	NOR	Quad	14	TC74VHC02FK			
		Dual	4-input	14	TC74VHC27FK		
	OR	Quad	14	TC74VHC32FK	TC74VHCT32AFK		
		Quad	14	TC74VHC86FK			
	Inverter	Hex	14	TC74VHC04FK	TC74VHCT04AFK		
			Open-drain	14	TC74VHC05FK		TC74VHCV05FK
			Schmitt	14	TC74VHC14FK	TC74VHCT14AFK	TC74VHCV14FK
	Buffer	9-bit	20				TC74VHC9152FK
			Hex	14			TC74VHCV17FK
		Hex	Open-drain	14			TC74VHCV07FK
			9-bit	20			
	3-state Buffer	Quad	14	TC74VHC125FK	TC74VHCT125AFK		
			14	TC74VHC126FK	TC74VHCT126AFK		
		5-Bit Universal Schmitt Buffer	14				
							TC74VHCT9125AFK
							TC74VHC9126FK
Octal		Inverted	20	TC74VHC240FK	TC74VHCT240AFK	TC74VHCV240FK	
	20		TC74VHC540FK	TC74VHCT540AFK	TC74VHCV540FK		
	20		TC74VHC244FK	TC74VHCT244AFK	TC74VHCV244FK		
	20		TC74VHC541FK	TC74VHCT541AFK	TC74VHCV541FK		
Universal Schmitt Buffer	20					TC74VHC9541FK	
						TC74VHCT9541AFK	
Flip-Flop	Transceiver	Octal	20	TC74VHC245FK	TC74VHCT245AFK	TC74VHCV245FK	
			Dual	14	TC74VHC74FK		
		Hex	16	TC74VHC174FK			
			Octal	20	TC74VHC273FK		
	3-state	Octal	20	TC74VHC374FK		TC74VHCV374FK	
			20	TC74VHC574FK	TC74VHCT574AFK	TC74VHCV574FK	
Latch	3-state	Octal	20	TC74VHC373FK		TC74VHCV373FK	
			20	TC74VHC573FK	TC74VHCT573AFK	TC74VHCV573FK	
Multi-vibrator	Dual	16	TC74VHC123AFK				
		16	TC74VHC221AFK				
Decoder	3 to 8 line	Single	16	TC74VHC138FK	TC74VHCT138AFK		
			16	TC74VHC238FK			
			16	TC74VHC139FK			
Shift Register	2 to 4 line 8bit	Dual	14	TC74VHC164FK			
			S-in / P-out	16			
			S-in / P-out, P-in / S-out	16			TC74VHC9164FK
			P-in / S-out	16	TC74VHC165FK		
Counter	Binary	Single 4bit with Async. Clear	16	TC74VHC161FK			
			16	TC74VHC163FK			
		Dual 4bit	14	TC74VHC393FK			
			Single 14-stage	16	TC74VHC4020FK		
Multi-plexer	Digital	Dual-4ch.	16	TC74VHC153FK			
			16	TC74VHC157FK			
			16	TC74VHC4051AFK			
			16	TC74VHC4052AFK			
Analog	Single-8ch.	16	TC74VHC4053AFK				
		16	TC74VHC4053AFK				
		16	TC74VHC4053AFK				
Other	Analog switch	Quad	14	TC74VHC4066AFK			
			14	TC74VHC4066AFK			

# Standard Logic 74LCX Series, 74VCX Series (US14 / 16 / 20 Package Products)

Package Dimensions (unit: mm)

US14	US16	US20	Features
 4.0 x 4.0	 4.0 x 4.0	 5.0 x 4.0	• Small mounting area and thin package

Series name				LCX	VCX		
<b>Characteristics and Features</b>				Supply voltage range	1.65 to 3.6 V to 5.5 V (DS and DT)	1.2 to 3.6 V	
				Output current @V <sub>CC</sub> = 3 V	±24 mA	±24 mA	
				Power down protection on inputs	Yes	Yes	
				Power down protection on outputs	Yes	Yes	
<b>Function</b>			<b>Pin</b>	-	-		
Gate / Buffer	NAND	Quad	14	TC74LCX00FK	TC74VCX00FK		
	AND	Quad	14	TC74LCX08FK	TC74VCX08FK		
	NOR	Quad	14	TC74LCX02FK	TC74VCX02FK		
	OR	Quad	14	TC74LCX32FK	TC74VCX32FK		
	Exclusive-OR	Quad	14	TC74LCX86FK			
	Inverter	Hex		14	TC74LCX04FK	TC74VCX04FK	
			Open-drain	14	TC74LCX05FK		
			Schmitt	14	TC74LCX14FK	TC74VCX14FK	
	Buffer	Hex	Open-drain	14	TC74LCX07FK		
	3-state Buffer	Quad		14	TC74LCX125FK	TC74VCX125FK	
				14	TC74LCX126FK		
			Series resistor	14		TC74VCX2125FK	
		Octal	Inverted		20	TC74LCX240FK	
					20	TC74LCX540FK	
					20	TC74LCX244FK	TC74VCX244FK
	20			TC74LCX541FK	TC74VCX541FK		
	Series resistor		20		TC74VCX2244FK		
			20		TC74VCX2541FK		
			20		TC74VCX245FK		
Transceiver	Octal	20	TC74LCX245FK	TC74VCX245FK			
Flip-Flop		Dual	14	TC74LCX74FK			
		Octal	20	TC74LCX273FK			
	3-state	Octal		20	TC74LCX374FK		
				20	TC74LCX574FK	TC74VCX574FK	
				20	TC74LCX373FK		
Latch	3-state	Octal	20	TC74LCX573FK			
			20	TC74LCX573FK			
Decoder	3 to 8 line	Single	16	TC74LCX138FK	TC74VCX138FK		
Multi-plexer	Digital	Quad-2ch.	16	TC74LCX157FK	TC74VCX157FK		
		3-state	16	TC74LCX257FK	TC74VCX257FK		

1 MOSFETS

2 Tr./BRTs

3 Diodes

4 Power Management ICs

5 Linear ICs

6 Sensors







7 General Purpose Logic ICs

8 RF Devices

9 Packages

# ■ Standard Logic 74HC Series, TC4000B Series (SOIC14 / 16 / 20, SOP14 / 16 / 20 Package Products)

Package Dimensions (unit: mm)

SOIC14	SOIC16	SOIC20	SOP14	SOP16	SOP20
					
8.65 x 6.0	9.9 x 6.0	12.8 x 10.3	10.3 x 7.8	10.3 x 7.8	12.8 x 7.8

Series name		SOIC Package			SOP Package					
		HC	HCT (TTL Input)	HC	HCT (TTL Input)	Standard series				
Characteristics and Features	Supply voltage range	2 to 6 V	4.5 to 5.5 V	2 to 6 V	4.5 to 5.5 V	3 to 18 V				
	Output current @V <sub>CC</sub> = 4.5 V	±4 or ±6 mA	±4 or ±6 mA	±4 or ±6 mA	±4 or ±6 mA	±0.51 mA (@V <sub>CC</sub> = 5 V)				
	Power down protection on inputs	No		No		No				
	Power down protection on outputs	No		No		No				
Function		Pin		Pin		Pin				
Gate/ Buffer	NAND	Quad	14	74HC00D †	-	-	-	-		
			14	74HC03D †	-	-	-	-		
		Dual	Open-drain	14	74HC03D †	-	-	-	-	
			Schmitt	14		TC74HC132AF			TC4093BF	
	4-input	Dual	14		TC74HC20AF					
		Dual	14	74HC08D †		TC74HC08AF		TC4081BF		
	AND	Dual	4-input	14		TC74HC21AF				
			14	74HC08D †		TC74HC02AF		TC4001BF		
	NOR	Quad	14	74HC32D †		TC74HC32AF		TC4071BF		
			14	74HC86D †		TC74HC32AF		TC4030BF		
	OR	Quad	14	74HC86D †						
			14	74HC04D †		TC74HC04AF	TC74HCT04AF			
			16			TC74HC4049AF		TC4049BF		
			14	Unbuffer	14		TC74HCU04AF		TC4069UBF	
	Exclusive-OR	Quad	Open-drain	14	74HC05D †		TC74HC05AF			
			Schmitt	14	74HC14D †	74HCT14D †	TC74HC14AF		TC4584BF	
			14	74HC14D †		TC74HC4050AF		TC4050BF		
			16			TC74HC07AF				
	Inverter	Hex	Open-drain	14						
			14							
Buffer	Hex	Open-drain	14							
		16								
		14								
		14								
	3-state Buffer	Quad	14	74HC125D †		TC74HC125AF				
			14	74HC126D †		TC74HC126AF				
		Hex	Universal	14			TC74HC365AF			
				14			TC74HC366AF			
			Octal	Inverted	20			TC74HCT7007AF		
					20			TC74HC240AF	TC74HCT240AF	
Transceiver	Octal	Inverted	20			TC74HC540AF	TC74HCT540AF			
			20			TC74HC7240AF				
		Non-inverted	20			TC74HC241AF				
			20			TC74HC244AF		TC74HCT244AF		
		20			TC74HC7244AF					
		20			TC74HC541AF		TC74HCT541AF			
20			TC74HC640AF							
Flip-Flop	Dual	14			TC74HC245AF					
		16	74HC175D †	74HCT175D †	TC74HC74AF		TC4013BF			
	Hex	16	74HC175D †		TC74HC175AF					
		20	74HC273D †		TC74HC273AF					
3-state	Octal	20	74HC374D †		TC74HC374AF					
		20	74HC574D †		TC74HC574AF					
Latch	8-Bit Addressable Latch	16	74HC259D †							
		20	74HC373D †		TC74HC373AF					
Multi-vibrator	Dual Monostable	16	74HC573D †		TC74HC573AF					
		16			TC74HC573AF					
Decoder	3 to 8 line	Single	16			TC74HC123AF				
			16	74HC423AF		TC74HC423AF				
	3 to 8 line / Latch	BCD-to-Seven Segment Latch / Decoder / Driver	16	74HC4538D †		TC74HC4538AF		TC4538BF		
			16	74HC4538D †		TC74HC424AF				
Shift Register	8bit	S-in / P-out	16	74HC138D †		TC74HC138AF				
			16	74HC238D †				TC4511BF		
		P-in / S-out	16	74HC237D †						
			16	74HC237D †						
		With Output Register	16	74HC166D †		TC74HC165AF		TC4021BF		
			16	74HC594D †						
Counter	Binary	Latch (3-state)	16	74HC595D †		TC74HC595AF				
			16	74HC595D †				TC4094BF		
		8-Stage Shift-and-Store	14-stage	16			TC74HC4020AF		TC4020BF	
			12-stage	16			TC74HC4040AF		TC4040BF	
		Single 14-Stage / Oscillator	Single Decade Counter/Divider	16			TC74HC4060AF			
			Dual Binary Up Counter	16					TC4017BF	
Multi-plexer	Digital	Programmable Divider / Timer	16			TC74HC7292AF				
			16			TC74HC151AF				
		Single-8ch.	16	74HC151D †						
			Single-8ch. 3-state	16			TC74HC251AF			
		Dual-4ch.	16			TC74HC153AF				
			Dual-4ch. 3-state	16			TC74HC253AF			
Analog	Quad-2ch.	16			TC74HC157AF					
		16	74HC4051D †	74HCT4051D †	TC74HC4051AF		TC4051BF			
		16	74HC4052D †	74HCT4052D †	TC74HC4052AF		TC4052BF			
		16	74HC4053D †	74HCT4053D †	TC74HC4053AF	TC74HCT4053AF	TC4053BF			
Other	Analog switch Quad	14	74HC4066D †		TC74HC4066AF		TC4066BF			

† Operating temperature: T<sub>opr</sub> = -40 to 125 °C



# Standard Logic TC74VCX Series, TC74LCX Series (TSSOP14 / 16 / 20 / 48 Package Products)

Package Dimensions (unit: mm)

TSSOP14	TSSOP16	TSSOP20	TSSOP48
			
5.0 x 6.4	5.0 x 6.4	6.5 x 6.4	12.5 x 8.1

Series name				TSSOP Package		
				TC74VCX	TC74LCX	
Characteristics and Features		Supply voltage range		1.2 to 3.6 V	1.65 to 3.6 V	
		Output current @V <sub>CC</sub> = 3 V		±24 mA	±24 mA	
		Power down protection on inputs		Yes		
		Power down protection on outputs		Yes		
Function				-	-	
Gate / Buffer	NAND	Quad	Pin	TC74VCX00FT †		
	AND	Quad	14	TC74VCX08FT †		
	NOR	Quad	14	TC74VCX02FT †		
	OR	Quad	14	TC74VCX32FT †		
	Inverter	Hex		14	TC74VCX04FT †	
			Schmitt	14	TC74VCX14FT †	
	3-state Buffer	Quad		14	TC74VCX125FT †	
			Series resistor	14	TC74VCX2125FT †	
		Octal		20	TC74VCX244FT †	
				20	TC74VCX541FT †	
			Series resistor	20	TC74VCX2244FT †	
			20	TC74VCX2541FT †		
	16bit		48		TC74LCX16244 †	
	Transceiver	Octal		20	TC74VCX245FT †	
		16bit		48	TC74VCX16245 †	TC74LCX16245 †
			Bus hold	48	TC74VCXH16245 †	
Series resistor			48	TC74VCXR162245 †		
Bus hold + Series resistor			48	T74VCXHR162245 †		
Flip-Flop	3-state	Octal	14	TC74VCX574FT †		
Decoder	3 to 8 line	Single	16	TC74VCX138FT †		
Multiplexer	Digital	Quad-2ch.	16	TC74VCX157FT †		
		3-state	16	TC74VCX257FT †		

† Operating temperature: T<sub>opr</sub> = -40 to 125 °C



## 7-3 Bus Switches

### ■ High-Speed Transmission Type

Package Dimensions (unit: mm)

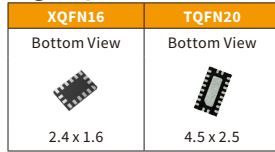



#### High-Speed Transmission Type



Recommended application	Interface Speed	Part Number	Package	Number of lane	Specification			Pin Assignment	Switch function
					Supply Voltage Range	Band width @-3 dB (typ.)	Quiescent Supply Current (max)		
USB4® PCIe®-Gen5 Thunderbolt 4™ DP2.0™	to 32 Gbps	TDS4A212MX ☆	XQFN16	1 lane	1.6 to 3.6 V	26.2 GHz @V <sub>cc</sub> = 1.6 to 3.6 V	150 μA @V <sub>cc</sub> = 3.6 V		SPDT
		TDS4B212MX ☆				27.5 GHz @V <sub>cc</sub> = 1.6 to 3.6 V			
USB3.1 PCIe®-Gen3	to 10 Gbps	TC7PCI3212MT	TQFN20	1 lane	3 to 3.6 V	11.5 GHz @V <sub>cc</sub> = 3.3 V	500 μA @V <sub>cc</sub> = 3.6 V		SPDT
		TC7PCI3215MT							

#### for USB2.0 and others



Recommended application	Interface Speed	Part Number	Package	Number of circuit	Specification			Pin Assignment	Switch function
					Supply Voltage Range	Band width @-3 dB (typ.)	Quiescent Supply Current (max)		
USB2.0 PCIe®-Gen1 HDMI™1.4 SATA2.0 SAS1.0	to 3.4 Gbps	TC7USB40MU	UQFN10B	2	2.3 to 4.3 V	1.5 GHz @V <sub>cc</sub> = 3.3 V	1 μA @V <sub>cc</sub> = 4.3 V		SPDT
		TC7USB42MU							
		TC7USB40FT	TSSOP14						
		TC7USB42FT							

☆ New Products

- USB4® USB4 is a registered trademark of USB Implementers Forum.
- PCIe® PCIe is a registered trademark of PCI-SIG.
- HDMI™ HDMI, HDMI High-Definition Multimedia Interface and the HDMI logo are trademarks or registered trademarks of HDMI Licensing LLC in the United States and other countries.
- Thunderbolt™ Thunderbolt is a trademark of Intel Corporation or its subsidiaries.
- DP™ DisplayPort, the DisplayPort logo, and the DisplayPort Certified Logo are trademarks or registered trademarks of the Video Electronics Standards Association in the United States and other countries

# General Purpose Bus Switches

Package Dimensions (unit: mm)

USV (SOT-353)	XSON6 (MP6D)	US6 (SOT-363)	US8 (SOT-765)	US14	US16	US20	TSSOP14B	TSSOP16B	TSSOP20B
	Bottom View 								
2.0 x 2.1	1.45 x 1.0	2.0 x 2.1	2.0 x 3.1	4.0 x 4.0	4.0 x 4.0	5.0 x 4.0	5.0 x 6.4	5.0 x 6.4	6.5 x 6.4

## 5 V Bus Switch

Switch function	Part Number	Package	Number of circuit	Switch type	Specification			
					Supply Voltage Range	Switch I/O Capacitance @Switch OFF (typ.)	Switch ON Resistance @V <sub>cc</sub> = 4.5 V, V <sub>is</sub> = 0 V (typ.)	Quiescent Supply Current (max)
SPST	TC7SB66CFU # †	USV	1	P-ch + N-ch	1.65 to 5.5 V	5 pF @V <sub>cc</sub> = 5 V	4 Ω @I <sub>is</sub> = 30 mA	10 μA @V <sub>cc</sub> = 5.5 V
	TC7SB67CFU # †							
	TC7WB66CFK # †	US8	2					
	TC7WB67CFK # †							
SPDT	TC7SB3157CFU # †	US6	1	P-ch + N-ch	1.65 to 5.5 V	5 pF @V <sub>cc</sub> = 5 V	4 Ω @I <sub>is</sub> = 30 mA	10 μA @V <sub>cc</sub> = 5.5 V
	TC7SB3157DL6X	XSON6 (MP6D)						

## Low-Voltage Bus Switch

Switch function	Part Number	Package	Number of circuit	Switch type	Specification			
					Supply Voltage Range	Switch I/O Capacitance	Switch ON Resistance @V <sub>cc</sub> = 3 V, V <sub>is</sub> = 0 V (typ.)	Quiescent Supply Current
SPST	TC7SBL66CFU # †	USV	1	P-ch + N-ch	1.65 to 3.6 V	3.5 pF @V <sub>cc</sub> = 3 V	6.5 Ω @I <sub>is</sub> = 30 mA	10 μA @V <sub>cc</sub> = 3.6 V
	TC7SBL384CFU # †							
	TC7WBL3305CFK # †	US8	2					
	TC7WBL3306CFK # †							
	TC7MBL3125CFK	US14	4					
	TC7MBL3125CFT # †	TSSOP14B						
	TC7MBL3126CFK	US14						
	TC7MBL3126CFT # †	TSSOP14B						
TC7MBL3245CFK	US20	8						
TC7MBL3245CFT # †	TSSOP20B							
SPDT	TC7MBL3257CFK	US16	4	P-ch + N-ch	1.65 to 3.6 V	5 pF @V <sub>cc</sub> = 3 V, A-port	8.5 Ω @I <sub>is</sub> = 30 mA	10 μA @V <sub>cc</sub> = 3.6 V
	TC7MBL3257CFT # †	TSSOP16B						
SP4T	TC7MBL3253CFK	US16	2	P-ch + N-ch	1.65 to 3.6 V	9 pF @V <sub>cc</sub> = 3 V, A-port	9 Ω @I <sub>is</sub> = 30 mA	10 μA @V <sub>cc</sub> = 3.6 V
	TC7MBL3253CFT # †	TSSOP16B						

# This device is compliant with the reliability requirements of AEC-Q100

† Operation temperature is -40 to 125 °C

# 7-4 Level Shifters

Package Dimensions (unit: mm)

FSV (SOT-953)	UF6 (SOT-363F)	USV (SOT-353)	US8 (SOT-765)	US16	TSSOP16B	TSSOP48
						
1.0 x 1.0	2.0 x 2.1	2.0 x 2.1	2.0 x 3.1	4.0 x 4.0	5.0 x 6.4	12.5 x 8.1

## Bus Buffer Type

Direction	Part Number	Package	Bit Count	Control Input	Function						
					Supply Voltage Range		Gate or Buffer	Sleep Mode	Low Noise	Series Resistor or Bus Hold	
					V <sub>CCA</sub> (V)	V <sub>CCB</sub> (V)					
Bidirectional	TC7MP3125FK	US16	4	Active-Low (A side)	1.1 to 2.7	1.65 to 3.6	3-State Buffer	✓			
	TC7MP3125FT # †	TSSOP16B						✓			
	TC7MPN3125FK	US16						✓	✓		
	TC7MPN3125FT # †	TSSOP16B						✓	✓		
	74LVC2T45FK ☆ †	US8	2	None	1.65 to 5.5	Buffer					
	74AVC4T245FT ☆ †	TSSOP16B	4	Active-Low (A side)	0.8 to 3.6	3-State Buffer				Bus Hold	
	74AVCH4T245FT ☆ †										
	74AVC4T345FT ☆ †										
	TC74VCX163245 †										
	TC74VCX164245 †	TSSOP48	16	Active-Low (B side)	2.3 to 3.6	1.65 to 2.7	3-State Buffer				
TC74LCX163245 †	2.3 to 3.6							2.3 to 3.6			
TC74LCX164245 †	4.5 to 5.5							2.3 to 3.6			Series Resistor
TC74LCXR163245 †	2.3 to 3.6							4.5 to 5.5			Series Resistor
TC74LCXR164245 †											
Unidirectional	TC7SP3125TU	UF6	1	Active-Low (A side)	1.1 to 2.7	1.65 to 3.6	3-State Buffer	✓			
	TC7SPN3125TU							✓	✓		
	TC7WP3125FK †	US8	2	Active-Low (A side)	1.1 to 2.7	1.65 to 3.6	3-State Buffer	✓			
	TC7WPN3125FK †							✓	✓		
	74LV4T125FT # †	TSSOP16B	4	Active-Low	1.65 to 5.5	(Single Supply)	3-State Buffer				
	74LV4T125FK †	US16									
	74LV4T126FT # †	TSSOP16B						Active-High			
	74LV4T126FK †	US16									
	7UL1T00FS †	fsv	1	None	2.3 to 3.6	(Single Supply)	3-State Buffer	NAND			
	7UL1T02FS †							NOR			
	7UL1T04FS †							Inverter			
	7UL1T08FS †							AND			
	7UL1T32FS †							OR			
	7UL1T34FS †							Buffer			
	7UL1T86FS †							Exclusive-OR			
	7UL1T125FS †							3-State Buffer			
	7UL1T126FS †							3-State Buffer			
	7UL1T00FU †							USV	1	None	2.3 to 3.6
	7UL1T02FU †	NOR									
	7UL1T04FU †	Inverter									
	7UL1T08FU †	AND									
	7UL1T32FU †	OR									
	7UL1T34FU †	Buffer									
	7UL1T86FU †	Exclusive-OR									
7UL1T125FU †	3-State Buffer										
7UL1T126FU †	3-State Buffer										
7UL1T126FU †	3-State Buffer										

☆ New Products

# This device is compliant with the reliability requirements of AEC-Q100

† Operation temperature is -40 to 125 °C

UF6 (SOT-363F)	US8 (SOT-765)	US14	US20	TSSOP14B	TSSOP20B	XSON6 (MP6D)
						
2.0 x 2.1	2.0 x 3.1	4.0 x 4.0	5.0 x 4.0	5.0 x 6.4	6.5 x 6.4	Bottom View 1.45 x 1.0

### Bus Buffer Type

Direction	Part Number	Package	Bit Count	Control Input	Function						
					Supply Voltage Range		Gate or Buffer	Sleep Mode	Low Noise	Series Resistor or Bus Hold	
					V <sub>CCA</sub> (V)	V <sub>CCB</sub> (V)					
Unidirectional	7UL1T00NX ★ †	XSON6 (MP6D)	1	None	2.3 to 3.6	-	(Single Supply)	NAND			
	7UL1T02NX ★ †							NOR			
	7UL1T04NX ★ †							Inverter			
	7UL1T08NX ★ †							AND			
	7UL1T32NX ★ †							OR			
	7UL1T34NX ★ †							Buffer			
	7UL1T86NX ★ †							Exclusive-OR			
	7UL1T125NX ★ †	US8	2	None	2.3 to 3.6	-	(Single Supply)	3-State Buffer			
	7UL1T126NX ★ †							3-State Buffer			
	7UL2T00FK †							NAND			
	7UL2T02FK †							NOR			
	7UL3T04FK †							Inverter			
	7UL2T08FK †							AND			
	7UL2T32FK †							OR			
7UL3T34FK †	Buffer										
7UL2T86FK †	Exclusive-OR										
7UL2T125FK †	2	Active-Low	Active-High	2.3 to 3.6	-	(Single Supply)	3-State Buffer				
7UL2T126FK †							3-State Buffer				

### Bus Switch Type

Switch function	Part Number	Package	Bit Count	Control Input	Specification			
					Supply Voltage Range		Switch I/O Capacitance @Switch OFF (typ.)	Switch ON Resistance @V <sub>CCA</sub> =3 V, V <sub>CCB</sub> =4.5 V, I <sub>IS</sub> =0 V (max)
					V <sub>CCA</sub> (V)	V <sub>CCB</sub> (V)		
SPST	TC7SPB9306TU	UF6	1	Active-High (A side)	1.65 to 5	2.3 to 5.5	7 pF @V <sub>CCA/B</sub> =3.3 V	8 Ω @I <sub>IS</sub> =30 mA
	TC7SPB9307TU			Active-Low (A side)				
	TC7WPB9306FK # †	US8	2	Active-High (A side)				
	TC7WPB9307FK # †			Active-Low (A side)				
	TC7QP9306FK	US14	4	Active-High (A side)				
	TC7QP9306FT # †	TSSOP14B		Active-High (A side)				
	TC7QP9307FK	US14	4	Active-Low (A side)				
	TC7QP9307FT # †	TSSOP14B		Active-Low (A side)				
	TC7MPB9307FK	US20	8	Active-Low (A side)				
TC7MPB9307FT # †	TSSOP20B	Active-Low (A side)						
SPDT	TC7MPB9326FK	US14	2	Active-High (A side)	1.65 to 5	2.3 to 5.5	7 pF @V <sub>CCA/B</sub> =3.3 V	8 Ω @I <sub>IS</sub> =30 mA
	TC7MPB9326FT # †	TSSOP14B		Active-High (A side)				
	TC7MPB9327FK	US14		Active-Low (A side)				
	TC7MPB9327FT # †	TSSOP14B		Active-Low (A side)				

☆ New Products, ★ Under Development (The specification is subject to change without notice.)  
 # This device is compliant with the reliability requirements of AEC-Q100  
 † Operation temperature is -40 to 125 °C

## 7-5 Part Naming Conventions

### Standard Logic

**74VHC T 244 A FT**

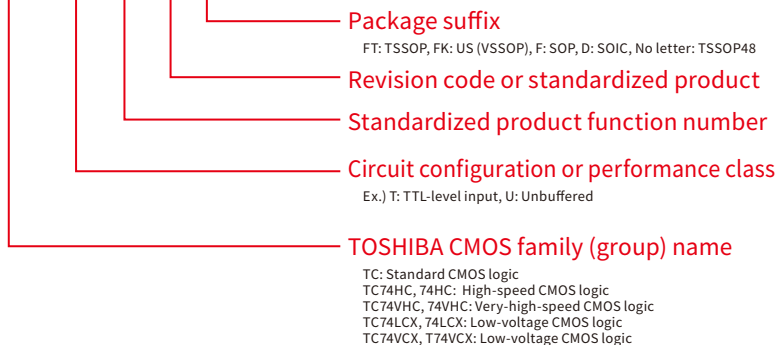

### One-Gate Logic

**TC7SZ 00 FS**

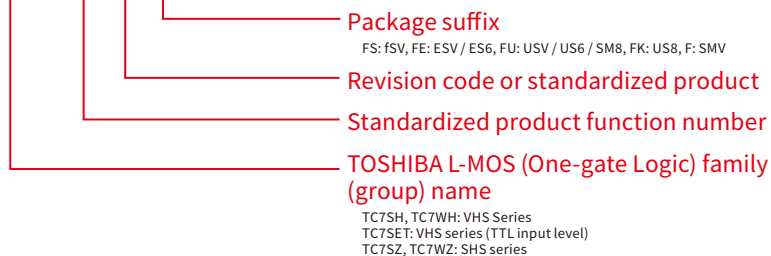

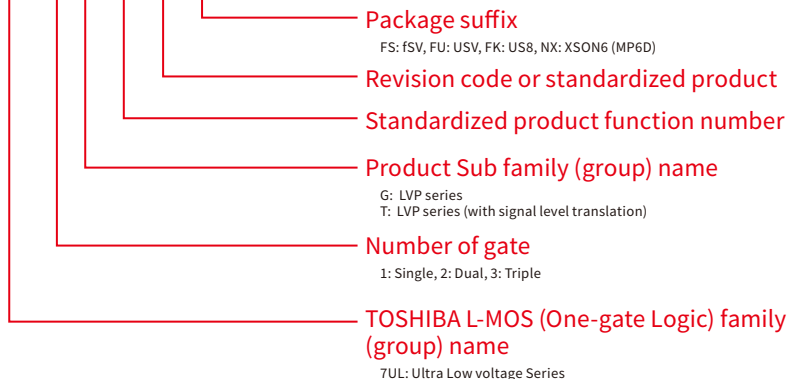

**7UL 1 G 00 FS**



# 8. Radio-Frequency Devices

## RF Diodes

Package Dimensions (unit: mm)

SOD-923	ESC (SOD-523)	USC (SOD-323)
		
1.0 x 0.6	1.6 x 0.8	2.5 x 1.25

### Variable Capacitance Diodes

Application	Part Number	Structure	Package	Absolute Maximum Ratings	Electrical Characteristics (Ta = 25 °C)						
					V <sub>R</sub> (V)	C <sub>T</sub> upper (pF)	@V <sub>R</sub> (V)	C <sub>T</sub> lower (pF)	@V <sub>R</sub> (V)	C <sub>T</sub> upper / C <sub>T</sub> lower	r <sub>s</sub> typ. (Ω)
VCO	1SV285	Single	ESC	10	4.5	1	2	4	2.3	0.42	1
	1SV277	Single	USC	10	4.5	1	2	4	2.3	0.42	1
	1SV311	Single	ESC	10	9.7 to 11.1	1	4.45 to 5.45	4	2.1	0.28	1
	1SV310	Single	USC	10	9.7 to 11.1	1	4.45 to 5.45	4	2.1	0.28	1
	1SV281	Single	ESC	10	16	1	8	4	2	0.28	1
	1SV270	Single	USC	10	16	1	8	4	2	0.28	1
	1SV305	Single	ESC	10	18.3	1	6.1	4	3	0.27	1
	1SV304	Single	USC	10	18.3	1	6.1	4	3	0.27	1
	1SV323	Single	ESC	10	26.5 to 29.5	1	6 to 7.1	4	4.3	0.4	4
	1SV322	Single	USC	10	26.5 to 29.5	1	6 to 7.1	4	4.3	0.4	4
	1SV325	Single	ESC	10	44 to 49.5	1	9.2 to 12	4	4.3	0.4	4
	1SV324	Single	USC	10	44 to 49.5	1	9.2 to 12	4	4.3	0.4	4
	JDV2S36E	Single	ESC	10	44 to 49.5	1	5.4 to 7.3	6	7.5	0.4	4
	1SV280	Single	ESC	15	3.8 to 4.7	2	1.5 to 2	10	2.4	0.44	1
	JDV2S42FS ☆	Single	SOD-923	15	3.8 to 4.7	2	1.5 to 2	10	2.4	0.44	1
	1SV239	Single	USC	15	4.25	2	1.75	10	2.4	0.44	1
	1SV279	Single	ESC	15	14 to 16	2	5.5 to 6.5	10	2.5	0.2	5
1SV229	Single	USC	15	14 to 16	2	5.5 to 6.5	10	2.5	0.2	5	
JDV2S41AFS ☆	Single	SOD-923	15	14 to 16	2	5.5 to 6.5	10	2.5	0.2	5	

☆ New Products

## RF Diodes

Package Dimensions (unit: mm)

SL2 (SOD-962)	SOD-923	ESC (SOD-523)	USC (SOD-323)	VESM (SOT-723)	SSM (SOT-416)	USM (SOT-323)	S-Mini (SOT-346)
Bottom View 							
0.62 x 0.32	1.0 x 0.6	1.6 x 0.8	2.5 x 1.25	1.2 x 1.2	1.6 x 1.6	2.0 x 2.1	2.9 x 2.5

## Schottky Barrier Diodes

Feature	Part Number	Structure	Package	Absolute Maximum Ratings		Electrical Characteristics (Ta = 25 °C)					
				V <sub>R</sub> (V)	I <sub>F</sub> (mA)	V <sub>F</sub> typ. (V)	@I <sub>F</sub> (mA)	I <sub>R</sub> max (μA)	@V <sub>R</sub> (V)	C <sub>T</sub> typ. (pF)	@V <sub>R</sub> (V)
Low V <sub>F</sub>	JDH2S02SL	Single	SL2	10	10	0.24	1	25	0.5	0.25	0.2
	JDH2S02FS ☆	Single	SOD-923	10	10	0.24	1	25	0.5	0.25	0.2
Standard	1SS315	Single	USC	5	30	0.25	2	25	0.5	0.6	0.2
	1SS154	Single	S-Mini	6	30	0.5	10	0.5	5	0.8	0
	JDH3D01FV	Series	VESM	4	25	0.25	2	25	0.5	0.6	0.2
	JDH3D01S	Series	SSM	4	25	0.25	2	25	0.5	0.6	0.2
	1SS295	Series	S-Mini	4	30	0.25	2	25	0.5	0.6	0.2
	1SS271	Series	S-Mini	6	30	0.5	10	0.5	5	0.8	0

☆ New Products

## Switching Diodes

Feature	Part Number	Structure	Package	Absolute Maximum Ratings		Electrical Characteristics (Ta = 25 °C)					
				V <sub>R</sub> (V)	I <sub>F</sub> (mA)	V <sub>F</sub> typ. (V)	@I <sub>F</sub> (mA)	C <sub>T</sub> typ. (pF)	@V <sub>R</sub> (V)	r <sub>s</sub> typ. (Ω)	@I <sub>F</sub> (mA)
Standard PIN diode	1SV308	Single	ESC	30	50	0.95	50	0.3	1	1	10
	1SV307	Single	USC	30	50	0.95	50	0.3	1	1	10
	JDP3C02AU	Cathode com.	USM	30	50	0.89	50	0.28	1	1	10
RF switching diode	1SS381	Single	ESC	30	100	0.85 (max)	2	0.7	6	0.6	2
	1SS314	Single	USC	30	100	0.85 (max)	2	0.7	6	0.5	2
	1SS364	Cathode com.	SSM	30	50	0.85 (max)	2	0.85	6	0.6	2
	1SS312	Cathode com.	USM	30	50	0.85 (max)	2	0.8	6	0.6	2
	1SS313	Anode com.	USM	30	50	0.85 (max)	2	0.8	6	0.6	2
	1SS268	Cathode com.	S-Mini	30	50	0.85 (max)	2	0.8	6	0.6	2
	1SS269	Anode com.	S-Mini	30	50	0.85 (max)	2	0.8	6	0.6	2



## ■ Part Naming Conventions

### Radio-Frequency Diode (EIAJ registration products)

Ex.) 1 S S 381  
 ① ② ③ ④

- ① The value that subtracted 1 from the total number of terminals
- ② S stands for Semiconductor
- ③ The kind of diode  
 This section shows the kind of the Radio Frequency diode being used.  
 ( It is omitted in certain cases. )  
 S: detection use, Frequency conversion use, and switching use  
 V: variable capacitance diode, PIN diode
- ④ Serial number

### Radio-Frequency Diode (EIAJ un-registration products)

Ex.) JD V 2 S 36 E  
 ① ② ③ ④ ⑤ ⑥

- ① JD means High-frequency diode
- ② The kind of devices  
 This section shows the kind of the devices being used.  
 It is classified into H, P, S, and V by the devices being loaded.  
 H: schottky barrier diode  
 P: PIN diode  
 S: band switching diode  
 V: variable capacitance diode
- ③ The number of terminals
- ④ Internal connection  
 This section shows the kind of the internal connection of a product.  
 S: single  
 C: cathode common  
 P: parallel
- ⑤ Serial number
- ⑥ Package type

AU	USM
S	SSM
E	ESC
SL	SL2
FV	VESM
FS, AFS	SOD-923

# 9. Device Packages

## 2 Pin packages

<p><b>SL2 (SOD-962) (0.62 x 0.32)</b></p> <p>Package dimension unit: mm</p>	<p><b>CL2E (1.0 x 0.6)</b></p> <p>Package dimension unit: mm</p>	<p><b>SOD-923 (1.0 x 0.6)</b></p> <p>Package dimension unit: mm</p>
<p>Land pattern example unit: mm</p>	<p>Land pattern example unit: mm</p>	<p>Land pattern example unit: mm</p>
<p><b>CST2 (SOD-882) (1.0 x 0.6)</b></p> <p>Package dimension unit: mm</p>	<p><b>CST2B (1.2 x 0.8)</b></p> <p>Package dimension unit: mm</p>	<p><b>CST2C (SOD-963) (1.6 x 0.8)</b></p> <p>Package dimension unit: mm</p>
<p>Land pattern example unit: mm</p>	<p>Land pattern example unit: mm</p>	<p>Land pattern example unit: mm</p>
<p><b>ESC (SOD-523) (1.6 x 0.8)</b></p> <p>Package dimension unit: mm</p>	<p><b>USC (SOD-323) (2.5 x 1.25)</b></p> <p>Package dimension unit: mm</p>	<p><b>US2H (SOD-323HE) (2.5 x 1.4)</b></p> <p>Package dimension unit: mm</p>
<p>Land pattern example unit: mm</p>	<p>Land pattern example unit: mm</p>	<p>Land pattern example unit: mm</p>

### 3 Pin packages

<p><b>CST3C (0.8 x 0.6)</b></p> <p>Package dimension unit: mm</p> <p>Bottom View</p>	<p><b>CST3 (SOT-883) (1.0 x 0.6)</b></p> <p>Package dimension unit: mm</p> <p>Bottom View</p>	<p><b>VESM (SOT-723) (1.2 x 1.2)</b></p> <p>Package dimension unit: mm</p>
<p>Land pattern example unit: mm</p>	<p>Land pattern example unit: mm</p>	<p>Land pattern example unit: mm</p>
<p><b>SSM (SOT-416) (1.6 x 1.6)</b></p> <p>Package dimension unit: mm</p>	<p><b>USM (SOT-323) (2.0 x 2.1)</b></p> <p>Package dimension unit: mm</p>	<p><b>UFM (SOT-323F) (2.0 x 2.1)</b></p> <p>Package dimension unit: mm</p>
<p>Land pattern example unit: mm</p>	<p>Land pattern example unit: mm</p>	<p>Land pattern example unit: mm</p>
<p><b>S-Mini (SOT-346) (2.9 x 2.5)</b></p> <p>Package dimension unit: mm</p>	<p><b>SOT23 (SOT-23) (2.9 x 2.4)</b></p> <p>Package dimension unit: mm</p>	<p><b>SOT-23F (2.9 x 2.4)</b></p> <p>Package dimension unit: mm</p>
<p>Land pattern example unit: mm</p>	<p>Land pattern example unit: mm</p>	<p>Land pattern example unit: mm</p>

4 Pin packages

<p><b>WCSP4E (0.645 x 0.645)</b></p> <p>Package dimension unit: mm</p>		<p><b>WCSP4F (0.645 x 0.645)</b></p> <p>Package dimension unit: mm</p>		<p><b>WCSP4G (0.645 x 0.645)</b></p> <p>Package dimension unit: mm</p>	
<p>Land pattern example unit: mm</p>		<p>Land pattern example unit: mm</p>		<p>Land pattern example unit: mm</p>	
<p><b>WCSP4D (0.79 x 0.79)</b></p> <p>Package dimension unit: mm</p>		<p><b>SDFN4E (0.8 x 0.8)</b></p> <p>Package dimension unit: mm</p>		<p><b>WCSP4C (0.9 x 0.9)</b></p> <p>Package dimension unit: mm</p>	
<p>Land pattern example unit: mm</p>		<p>Land pattern example unit: mm</p>		<p>Land pattern example unit: mm</p>	
<p><b>DFN4D (1.0 x 1.0)</b></p> <p>Package dimension unit: mm</p>		<p><b>DFN4E (1.0 x 1.0)</b></p> <p>Package dimension unit: mm</p>		<p><b>DFN4F (1.0 x 1.0)</b></p> <p>Package dimension unit: mm</p>	
<p>Land pattern example unit: mm</p>		<p>Land pattern example unit: mm</p>		<p>Land pattern example unit: mm</p>	

## 4 Pin packages

## 5 Pin packages

DFN4A (1.2 x 1.2)	DFN5 (1.3 x 0.8)	DFN5B (1.2 x 1.2)
<p>Package dimension unit: mm</p>	<p>Package dimension unit: mm</p>	<p>Package dimension unit: mm</p>
<p>Land pattern example unit: mm</p>	<p>Land pattern example unit: mm</p>	<p>Land pattern example unit: mm</p>

fSV (SOT-953) (1.0 x 1.0)	ESV (SOT-553) (1.6 x 1.6)	UFV (SOT-353F) (2.0 x 2.1)
<p>Package dimension unit: mm</p>	<p>Package dimension unit: mm</p>	<p>Package dimension unit: mm</p>
<p>Land pattern example unit: mm</p>	<p>Land pattern example unit: mm</p>	<p>Land pattern example unit: mm</p>

## 6 Pin packages

USV (SOT-353) (2.0 x 2.1)	SMV (SOT-25) (2.9 x 2.8)	WCSP6E (1.2 x 0.8)
<p>Package dimension unit: mm</p>	<p>Package dimension unit: mm</p>	<p>Package dimension unit: mm</p>
<p>Land pattern example unit: mm</p>	<p>Land pattern example unit: mm</p>	<p>Land pattern example unit: mm</p>

<p><b>WCSP6F (1.2 x 0.8)</b></p> <p>Package dimension unit: mm</p>	<p><b>WCSP6G (1.2 x 0.8)</b></p> <p>Package dimension unit: mm</p>	<p><b>DFN6 (1.25 x 1.0)</b></p> <p>Package dimension unit: mm</p>
<p>Land pattern example unit: mm</p>	<p>Land pattern example unit: mm</p>	<p>Land pattern example unit: mm</p>
<p><b>MP6C (1.45 x 1.0)</b></p> <p>Package dimension unit: mm</p>	<p><b>XSON6(MP6D) (1.45 x 1.0)</b></p> <p>Package dimension unit: mm</p>	<p><b>WCSP6C (1.5 x 1.0)</b></p> <p>Package dimension unit: mm</p>
<p>Land pattern example unit: mm</p>	<p>Land pattern example unit: mm</p>	<p>Land pattern example unit: mm</p>
<p><b>DFN2020(WF) (2.0 x 2.0)</b></p> <p>Package dimension unit: mm</p>	<p><b>UDFN6 (SOT-1118) (2.0 x 2.0)</b></p> <p>Package dimension unit: mm</p>	<p><b>UDFN6B (SOT-1220) (2.0 x 2.0)</b></p> <p>Package dimension unit: mm</p>
<p>Land pattern example unit: mm</p>	<p>Land pattern example unit: mm</p>	<p>Land pattern example unit: mm</p>

## 6 Pin packages

<p><b>TCSP6A-172101 (2.14 x 1.67)</b></p> <p>Package dimension unit: mm</p>	<p><b>ES6 (SOT-563) (1.6 x 1.6)</b></p> <p>Package dimension unit: mm</p>	<p><b>UF6 (SOT-363F) (2.0 x 2.1)</b></p> <p>Package dimension unit: mm</p>
<p>Land pattern example unit: mm</p>	<p>Land pattern example unit: mm</p>	<p>Land pattern example unit: mm</p>
<p><b>US6 (SOT-363) (2.0 x 2.1)</b></p> <p>Package dimension unit: mm</p>	<p><b>SM6 (SOT-26) (2.9 x 2.8)</b></p> <p>Package dimension unit: mm</p>	<p><b>TSOP6F (2.9 x 2.8)</b></p> <p>Package dimension unit: mm</p>
<p>Land pattern example unit: mm</p>	<p>Land pattern example unit: mm</p>	<p>Land pattern example unit: mm</p>

## 8 Pin packages

<p><b>WSON8 (2.0 x 2.0)</b></p> <p>Package dimension unit: mm</p>	<p><b>US8 (SOT-765) (2.0 x 3.1)</b></p> <p>Package dimension unit: mm</p>	<p><b>SM8 (SOT-505) (2.9 x 4.0)</b></p> <p>Package dimension unit: mm</p>
<p>Land pattern example unit: mm</p>	<p>Land pattern example unit: mm</p>	<p>Land pattern example unit: mm</p>

## 9 Pin packages

**WCSP9 (1.5 x 1.5)**

Package dimension unit: mm

Bottom View

Land pattern example unit: mm

**DFN10 (2.5 x 1.0)**

Package dimension unit: mm

Bottom View

Land pattern example unit: mm

**TCSPAC-153001 (2.98 x 1.49)**

Package dimension unit: mm

Bottom View

Land pattern example unit: mm

**TCSPAG-341501 (3.37 x 1.47)**

Package dimension unit: mm

Bottom View

Land pattern example unit: mm

**UQFN10B (1.4 x 1.8)**

Package dimension unit: mm

Bottom View

Land pattern example unit: mm

**WSN10 (3.0 x 3.0)**

Package dimension unit: mm

Bottom View

Land pattern example unit: mm

## 14 Pin packages

**WSN10B (3.0 x 3.0)**

Package dimension unit: mm

Bottom View

Land pattern example unit: mm

**TCSPED-302701 (3.0 x 2.74)**

Package dimension unit: mm

Bottom View

Land pattern example unit: mm

**US14 (4.0 x 4.0)**

Package dimension unit: mm

Bottom View

Land pattern example unit: mm



# 14 Pin packages

TSSOP14 (5.0 x 6.4)	TSSOP14B (5.0 x 6.4)	SOIC14 (8.65 x 6.0)
<p>Package dimension unit: mm</p>	<p>Package dimension unit: mm</p>	<p>Package dimension unit: mm</p>
<p>Land pattern example unit: mm</p>	<p>Land pattern example unit: mm</p>	<p>Land pattern example unit: mm</p>

# 16 Pin packages

SOP14 (10.3 x 7.8)	WCSP16C (1.9 x 1.9)	XQFN16 (2.4 x 1.6)
<p>Package dimension unit: mm</p>	<p>Package dimension unit: mm</p>	<p>Package dimension unit: mm</p>
<p>Land pattern example unit: mm</p>	<p>Land pattern example unit: mm</p>	<p>Land pattern example unit: mm</p>
<p>Package dimension unit: mm</p>	<p>Package dimension unit: mm</p>	<p>Package dimension unit: mm</p>
<p>Land pattern example unit: mm</p>	<p>Land pattern example unit: mm</p>	<p>Land pattern example unit: mm</p>

16 Pin packages

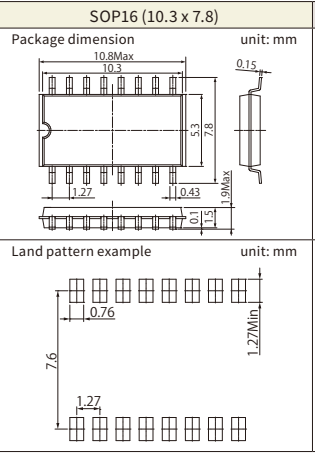
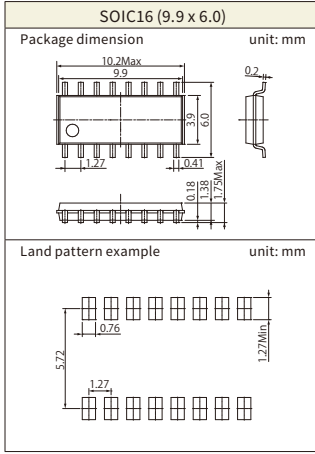

20 Pin packages

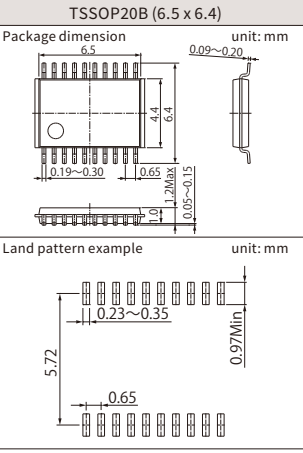
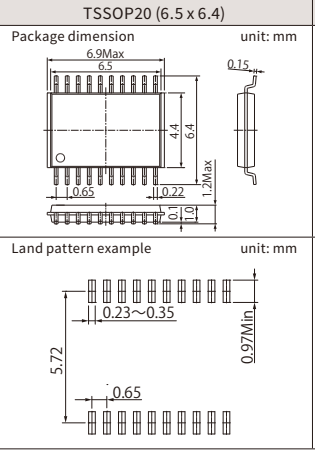
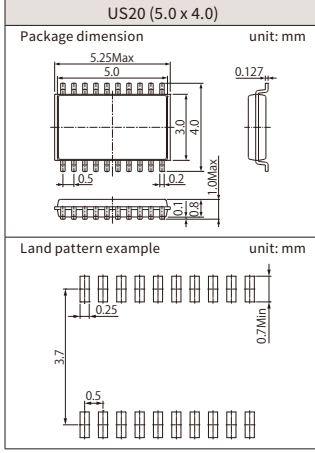
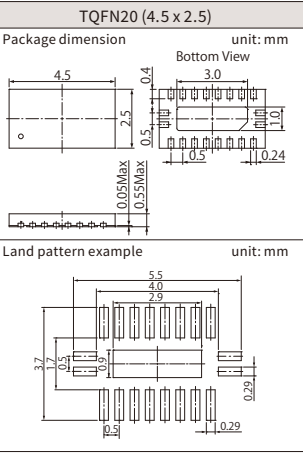

48 Pin packages

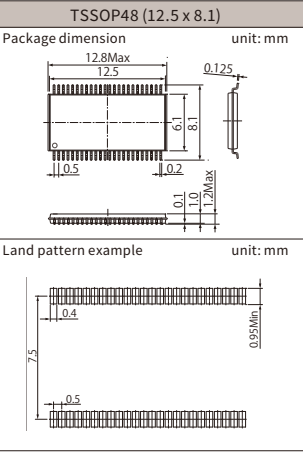
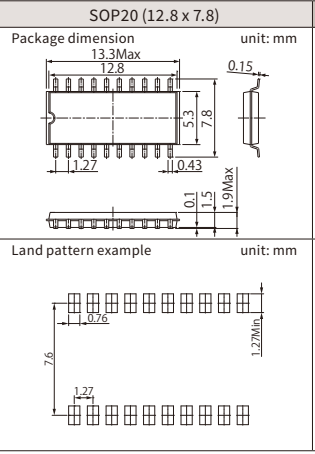
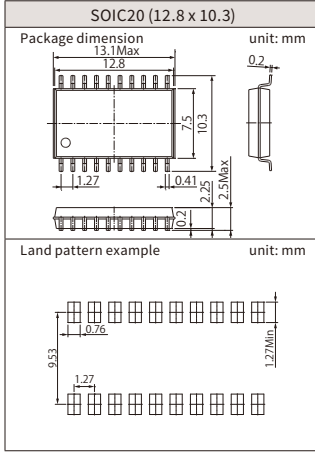



## RESTRICTIONS ON PRODUCT USE

Toshiba Corporation and its subsidiaries and affiliates are collectively referred to as "TOSHIBA".

Hardware, software and systems described in this document are collectively referred to as "Product".

- TOSHIBA reserves the right to make changes to the information in this document and related Product without notice.
- This document and any information herein may not be reproduced without prior written permission from TOSHIBA. Even with TOSHIBA's written permission, reproduction is permissible only if reproduction is without alteration/omission.
- Though TOSHIBA works continually to improve Product's quality and reliability, Product can malfunction or fail. Customers are responsible for complying with safety standards and for providing adequate designs and safeguards for their hardware, software and systems which minimize risk and avoid situations in which a malfunction or failure of Product could cause loss of human life, bodily injury or damage to property, including data loss or corruption. Before customers use the Product, create designs including the Product, or incorporate the Product into their own applications, customers must also refer to and comply with (a) the latest versions of all relevant TOSHIBA information, including without limitation, this document, the specifications, the data sheets and application notes for Product and the precautions and conditions set forth in the "TOSHIBA Semiconductor Reliability Handbook" and (b) the instructions for the application with which the Product will be used with or for. Customers are solely responsible for all aspects of their own product design or applications, including but not limited to (a) determining the appropriateness of the use of this Product in such design or applications; (b) evaluating and determining the applicability of any information contained in this document, or in charts, diagrams, programs, algorithms, sample application circuits, or any other referenced documents; and (c) validating all operating parameters for such designs and applications. **TOSHIBA ASSUMES NO LIABILITY FOR CUSTOMERS' PRODUCT DESIGN OR APPLICATIONS.**
- **PRODUCT IS NEITHER INTENDED NOR WARRANTED FOR USE IN EQUIPMENTS OR SYSTEMS THAT REQUIRE EXTRAORDINARILY HIGH LEVELS OF QUALITY AND/OR RELIABILITY, AND/OR A MALFUNCTION OR FAILURE OF WHICH MAY CAUSE LOSS OF HUMAN LIFE, BODILY INJURY, SERIOUS PROPERTY DAMAGE AND/OR SERIOUS PUBLIC IMPACT ("UNINTENDED USE").** Except for specific applications as expressly stated in this document, Unintended Use includes, without limitation, equipment used in nuclear facilities, equipment used in the aerospace industry, lifesaving and/or life supporting medical equipment, equipment used for automobiles, trains, ships and other transportation, traffic signaling equipment, equipment used to control combustions or explosions, safety devices, elevators and escalators, and devices related to power plant. **IF YOU USE PRODUCT FOR UNINTENDED USE, TOSHIBA ASSUMES NO LIABILITY FOR PRODUCT.** For details, please contact your TOSHIBA sales representative or contact us via our website.
- Do not disassemble, analyze, reverse-engineer, alter, modify, translate or copy Product, whether in whole or in part.
- Product shall not be used for or incorporated into any products or systems whose manufacture, use, or sale is prohibited under any applicable laws or regulations.
- The information contained herein is presented only as guidance for Product use. No responsibility is assumed by TOSHIBA for any infringement of patents or any other intellectual property rights of third parties that may result from the use of Product. No license to any intellectual property right is granted by this document, whether express or implied, by estoppel or otherwise.
- **ABSENT A WRITTEN SIGNED AGREEMENT, EXCEPT AS PROVIDED IN THE RELEVANT TERMS AND CONDITIONS OF SALE FOR PRODUCT, AND TO THE MAXIMUM EXTENT ALLOWABLE BY LAW, TOSHIBA (1) ASSUMES NO LIABILITY WHATSOEVER, INCLUDING WITHOUT LIMITATION, INDIRECT, CONSEQUENTIAL, SPECIAL, OR INCIDENTAL DAMAGES OR LOSS, INCLUDING WITHOUT LIMITATION, LOSS OF PROFITS, LOSS OF OPPORTUNITIES, BUSINESS INTERRUPTION AND LOSS OF DATA, AND (2) DISCLAIMS ANY AND ALL EXPRESS OR IMPLIED WARRANTIES AND CONDITIONS RELATED TO SALE, USE OF PRODUCT, OR INFORMATION, INCLUDING WARRANTIES OR CONDITIONS OF MERCHANTABILITY, FITNESS FOR A PARTICULAR PURPOSE, ACCURACY OF INFORMATION, OR NONINFRINGEMENT.**
- Do not use or otherwise make available Product or related software or technology for any military purposes, including without limitation, for the design, development, use, stockpiling or manufacturing of nuclear, chemical, or biological weapons or missile technology products (mass destruction weapons). Product and related software and technology may be controlled under the applicable export laws and regulations including, without limitation, the Japanese Foreign Exchange and Foreign Trade Law and the U.S. Export Administration Regulations. Export and re-export of Product or related software or technology are strictly prohibited except in compliance with all applicable export laws and regulations.
- Please contact your TOSHIBA sales representative for details as to environmental matters such as the RoHS compatibility of Product. Please use Product in compliance with all applicable laws and regulations that regulate the inclusion or use of controlled substances, including without limitation, the EU RoHS Directive. **TOSHIBA ASSUMES NO LIABILITY FOR DAMAGES OR LOSSES OCCURRING AS A RESULT OF NONCOMPLIANCE WITH APPLICABLE LAWS AND REGULATIONS.**

# TOSHIBA

Toshiba Electronic Devices & Storage Corporation  
Toshiba Electronic Device Solutions Corporation

<https://toshiba.semicon-storage.com/>