

## Introduction to Toshiba Switching Diode Line-up

Toshiba offers a wide range of switching diodes (Switching Diodes) mounted in small packages, including single-type and combined-type diodes.

### Toshiba, a leading company in diodes

Since Toshiba started mass production of diodes in 1956, it has been one of the major diode vendors who have continued to market products as a pioneer in the industry since the early days of semiconductors. Developed in 1966, M8555, our typical switching diode, is compact, high-performance, and low-cost, and has contributed to the times as the diode in terms of both name and reality. We will continue to provide a wide range of highly reliable diode products based on our experience in delivering products to many customers.

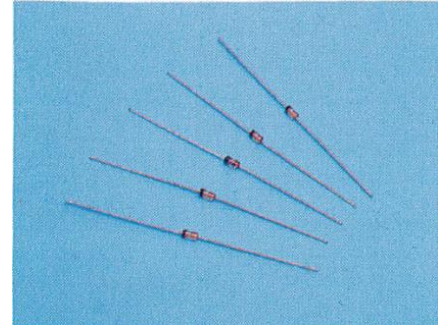

Switching diode : M8555

### High-quality, safe and secure delivery at plants in Japan and Thailand

Our diode products are mainly surface-mount type small packages. High-quality, stable production at plants in Japan and Thailand enables safe and safety delivery. We will respond quickly and seriously to sudden delivery problems as well.

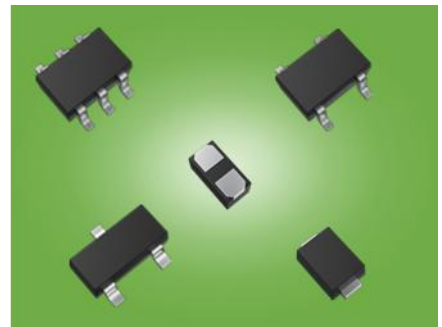

### Diode overview

A diode is a two-terminal semiconductor device with one PN junction or an alternate junction. Roughly speaking, they are classified as shown in the figure below. It is divided into rectifier diode, constant voltage diode, etc. according to structure and application, and it is widely used. This document mainly introduces switching diodes used as rectifier diodes.

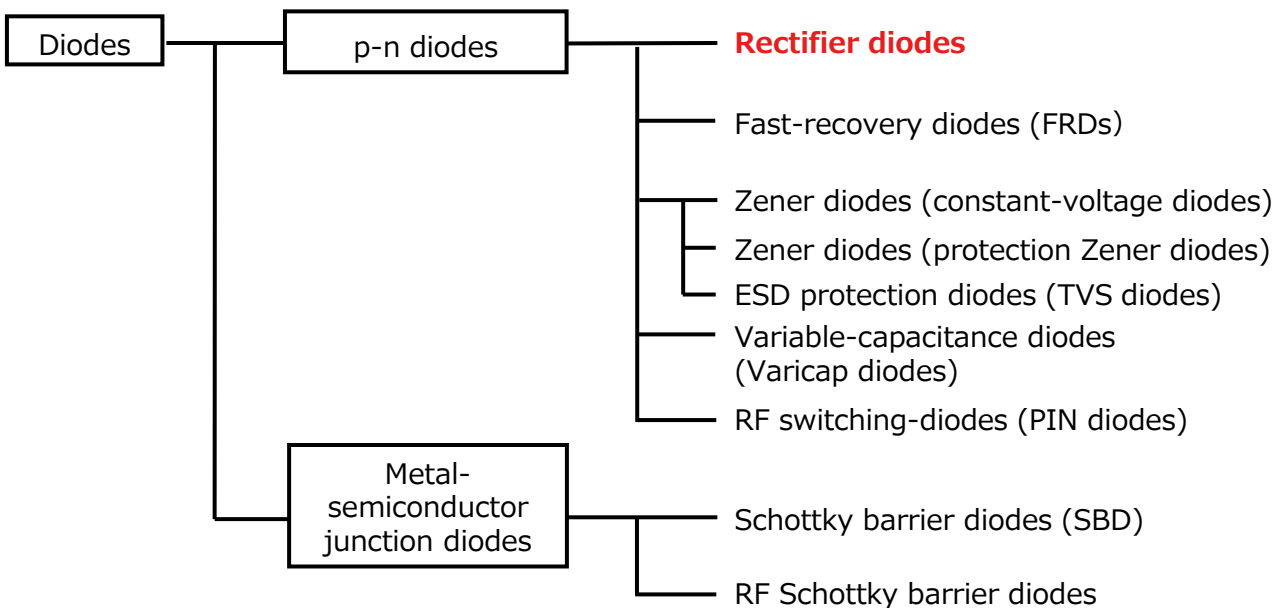

## Basic structure and operation of the switching diode

It has the property that current flows (in the forward direction) and current does not flow (in the reverse direction) according to the direction of the applied voltage. This function changes the alternating current (AC) voltage to direct current (DC). The electrode terminals are called the anode (Anode: A) and cathode (Cathode: K), and current flows when the anode electrode has a positive potential.

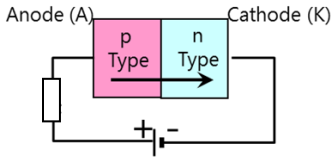

Schematic diagram of a diode

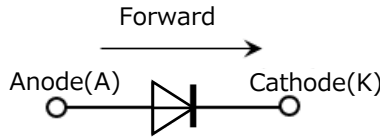

Symbol mark on the diode

Marking of cathode



Example of a switching diode package

With a switching diode area to be used.

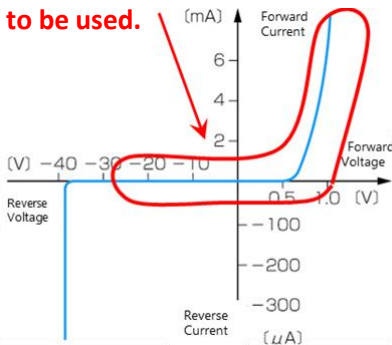

Current vs. Voltage Characteristics of Switching Diodes

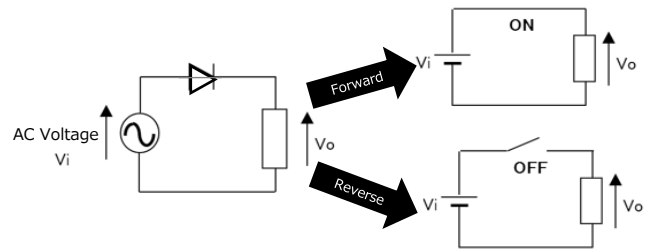

Forward and reverse voltage operation

Even if a forward current  $I_F$  is applied to the diode and a reverse voltage  $V_R$  is applied to the diode, P. While the minority carriers stored in the junction remain, the reverse direction is low impedance and a large reverse current  $I_R$  flows. The time from this cutoff until 10 % of the reverse current  $I_R$  is recovered is called the reverse recovery time  $t_{rr}$ , which represents the switching time of the diode. An example of the measurement circuit is shown in the figure below. The switching diode has a short reverse recovery time ( $t_{rr}$ ) and superior switching characteristics compared to other diodes. It also has a smaller reverse current  $I_R$  compared to other diodes. We offer a wide range of products for each package and rating. We would be happy if you could select the best product for your customer from the selection table of the following switching diodes.

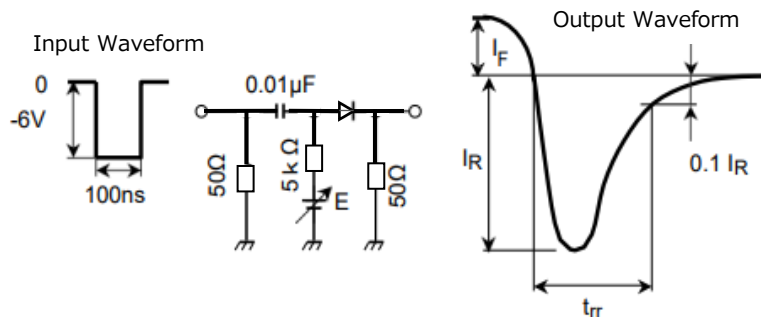

Reverse recovery time ( $t_{rr}$ ) measurement circuit and input/output waveforms















## •Switching diode selection table

### [Single product]

Part Number	VR (Max) (V)	IO (Max) (A)	Internal connection	Pins	Package (Toshiba)	AEC-Q101	Package dimensions (mm)	Buy Online
<a href="#">1SS387CT</a>	80	0.1	Single	2	CST2		1.0 x 0.6 x 0.38	
<a href="#">1SS387</a>	80	0.1	Single	2	ESC	Qualified*	1.6 x 0.8 x 0.6	
<a href="#">1SS403E</a>	200	0.1	Single	2	ESC		1.6 x 0.8 x 0.6	
<a href="#">BAS516</a>	100	0.25	Single	2	ESC		1.6 x 0.8 x 0.6	
<a href="#">1N4148WT</a>	100	0.25	Single	2	ESC		1.6 x 0.8 x 0.6	
<a href="#">1SS187</a>	80	0.1	Single	3	S-Mini	Qualified*	2.9 x 2.5 x 1.1	
<a href="#">1SS190</a>	80	0.1	Single	3	S-Mini		2.9 x 2.5 x 1.1	
<a href="#">1SS193</a>	80	0.1	Single	3	S-Mini	Qualified*	2.9 x 2.5 x 1.1	
<a href="#">1SS196</a>	80	0.1	Single	3	S-Mini	Qualified*	2.9 x 2.5 x 1.1	
<a href="#">1SS250</a>	200	0.1	Single	3	S-Mini		2.9 x 2.5 x 1.1	
<a href="#">1SS427</a>	80	0.1	Single	2	SOD-923		1.0 x 0.6 x 0.4	
<a href="#">TBAS16</a>	80	0.215	Single	3	SOT23		2.9 x 2.4 x 0.9	
<a href="#">1SS352</a>	80	0.1	Single	2	USC	Qualified*	2.5 x 1.25 x 0.9	
<a href="#">1SS403</a>	200	0.1	Single	2	USC	Qualified*	2.5 x 1.25 x 0.9	
<a href="#">BAS316</a>	100	0.25	Single	2	USC		2.5 x 1.25 x 0.9	
<a href="#">1N4148WS</a>	100	0.25	Single	2	USC		2.5 x 1.25 x 0.9	
<a href="#">1SS370</a>	200	0.1	Single	3	USM		2.0 x 2.1 x 0.9	

\*: For detail information, please contact to our sales.

### [2in1 product]

Part Number	VR (Max) (V)	IO (Max) (A)	Internal connection	Pins	Package (Toshiba)	AEC-Q101	Package dimensions (mm)	Buy Online
<a href="#">1SS181</a>	80	0.1	Anode common	3	S-Mini	Qualified*	2.9 x 2.5 x 1.1	
<a href="#">1SS184</a>	80	0.1	Cathode common	3	S-Mini	Qualified*	2.9 x 2.5 x 1.1	
<a href="#">1SS226</a>	80	0.1	Series	3	S-Mini	Qualified*	2.9 x 2.5 x 1.1	
<a href="#">1SS300</a>	80	0.1	Anode common	3	USM	Qualified*	2.0 x 2.1 x 0.9	
<a href="#">1SS301</a>	80	0.1	Cathode common	3	USM	Qualified*	2.0 x 2.1 x 0.9	
<a href="#">1SS302A</a>	80	0.1	Series	3	USM	Qualified*	2.0 x 2.1 x 0.9	
<a href="#">1SS360</a>	80	0.1	Anode common	3	SSM	Qualified*	1.6 x 1.6 x 0.7	
<a href="#">1SS361CT</a>	80	0.1	Cathode common	3	CST3		1.0 x 0.6 x 0.38	
<a href="#">1SS361FV</a>	80	0.1	Cathode common	3	VESM	Qualified*	1.2 x 1.2 x 0.5	
<a href="#">1SS361</a>	80	0.1	Cathode common	3	SSM	Qualified*	1.6 x 1.6 x 0.7	
<a href="#">1SS362FV</a>	80	0.1	Series	3	VESM	Qualified*	1.2 x 1.2 x 0.5	
<a href="#">1SS362</a>	80	0.08	Series	3	SSM		1.6 x 1.6 x 0.7	
<a href="#">BAV70</a>	100	0.215	Cathode common	3	SOT23		2.9 x 2.4 x 0.9	
<a href="#">BAV99W</a>	100	0.15	Series	3	USM		2.0 x 2.1 x 0.9	

<a href="#">BAV99</a>	100	0.215	Series	3	SOT23		2.9 x 2.4 x 0.9	<a href="#">Buy Online</a>
<a href="#">TBAV70</a>	80	0.215	Cathode common	3	SOT23		2.9 x 2.4 x 0.9	<a href="#">Buy Online</a>
<a href="#">TBAV99</a>	80	0.1	Series	3	SOT23		2.9 x 2.4 x 0.9	<a href="#">Buy Online</a>
<a href="#">TBAW56</a>	80	0.215	Anode common	3	SOT23		2.9 x 2.4 x 0.9	<a href="#">Buy Online</a>
<a href="#">HN2D01JE</a>	80	0.1	Independent	5	ESV		1.6 x 1.6 x 0.55	<a href="#">Buy Online</a>

\*: For detail information, please contact to our sales.

## [3in1 product]





Part Number	VR (Max) (V)	IO (Max) (A)	Internal connection	Pins	Package (Toshiba)	AEC-Q101	Package dimensions (mm)	Buy Online
<a href="#">HN2D01FU</a>	80	0.08	Independent	6	US6	Qualified*	2.0 x 2.1 x 0.9	<a href="#">Buy Online</a>
<a href="#">HN2D01F</a>	80	0.08	Independent	6	SM6		2.9 x 2.8 x 1.1	<a href="#">Buy Online</a>
<a href="#">HN2D02FU</a>	80	0.08	Independent	6	US6	Qualified*	2.0 x 2.1 x 0.9	<a href="#">Buy Online</a>

\*: For detail information, please contact to our sales.

## [4in1 product]

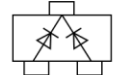
Part Number	VR (Max) (V)	IO (Max) (A)	Internal connection	Pins	Package (Toshiba)	AEC-Q101	Package dimensions (mm)	Buy Online
<a href="#">1SS308</a>	80	0.1	Anode common	5	SMV		2.9 x 2.8 x 1.1	<a href="#">Buy Online</a>
<a href="#">1SS309</a>	80	0.1	Cathode common	5	SMV		2.9 x 2.8 x 1.1	<a href="#">Buy Online</a>
<a href="#">HN1D01FE</a>	80	0.1	Anode common	6	ES6		1.6 x 1.6 x 0.55	<a href="#">Buy Online</a>
<a href="#">HN1D01FU</a>	80	0.1	Anode common	6	US6	Qualified*	2.0 x 2.1 x 0.9	<a href="#">Buy Online</a>
<a href="#">HN1D01F</a>	80	0.1	Anode common	6	SM6		2.9 x 2.8 x 1.1	<a href="#">Buy Online</a>
<a href="#">HN1D02FE</a>	80	0.1	Cathode common	6	ES6		1.6 x 1.6 x 0.55	<a href="#">Buy Online</a>
<a href="#">HN1D02FU</a>	80	0.1	Cathode common	6	US6	Qualified*	2.0 x 2.1 x 0.9	<a href="#">Buy Online</a>
<a href="#">HN1D02F</a>	80	0.1	Cathode common	6	SM6		2.9 x 2.8 x 1.1	<a href="#">Buy Online</a>
<a href="#">HN1D03FU</a>	80	0.1	Cathode common + Anode common	6	US6	Qualified*	2.0 x 2.1 x 0.9	<a href="#">Buy Online</a>
<a href="#">HN1D03F</a>	80	0.1	Cathode common + Anode common	6	SM6		2.9 x 2.8 x 1.1	<a href="#">Buy Online</a>
<a href="#">HN4D01JU</a>	80	0.1	Anode common	5	USV		2.0 x 2.1 x 0.9	<a href="#">Buy Online</a>
<a href="#">HN4D02JU</a>	80	0.1	Cathode common	5	USV		2.0 x 2.1 x 0.9	<a href="#">Buy Online</a>

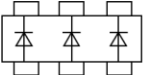
\*: For detail information, please contact to our sales.

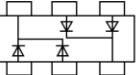
	Single(1in1)	2in1		3in1	4in1	
Connection example		 Ex.: Cathode common	 Ex.: Separate	 Ex.: Separate	 Ex.: Cathode common	
other connection	-	Series Anode common	-	-	Series Anode common	-

## LINK

- [Parametric search](#) [Click](#)
- [Application Notes](#) [Click](#)
- [Frequently Asked Questions \(FAQ\) of diodes](#) [Click](#)
- [Cross Reference Search](#) [Click](#)

Company names, product names, and service names may be trademarks of their respective companies.

## RESTRICTIONS ON PRODUCT USE

Toshiba Corporation and its subsidiaries and affiliates are collectively referred to as "TOSHIBA".

Hardware, software and systems described in this document are collectively referred to as "Product".

- TOSHIBA reserves the right to make changes to the information in this document and related Product without notice.
- This document and any information herein may not be reproduced without prior written permission from TOSHIBA. Even with TOSHIBA's written permission, reproduction is permissible only if reproduction is without alteration/omission.
- Though TOSHIBA works continually to improve Product's quality and reliability, Product can malfunction or fail. Customers are responsible for complying with safety standards and for providing adequate designs and safeguards for their hardware, software and systems which minimize risk and avoid situations in which a malfunction or failure of Product could cause loss of human life, bodily injury or damage to property, including data loss or corruption. Before customers use the Product, create designs including the Product, or incorporate the Product into their own applications, customers must also refer to and comply with (a) the latest versions of all relevant TOSHIBA information, including without limitation, this document, the specifications, the data sheets and application notes for Product and the precautions and conditions set forth in the "TOSHIBA Semiconductor Reliability Handbook" and (b) the instructions for the application with which the Product will be used with or for. Customers are solely responsible for all aspects of their own product design or applications, including but not limited to (a) determining the appropriateness of the use of this Product in such design or applications; (b) evaluating and determining the applicability of any information contained in this document, or in charts, diagrams, programs, algorithms, sample application circuits, or any other referenced documents; and (c) validating all operating parameters for such designs and applications. TOSHIBA ASSUMES NO LIABILITY FOR CUSTOMERS' PRODUCT DESIGN OR APPLICATIONS.
- PRODUCT IS NEITHER INTENDED NOR WARRANTED FOR USE IN EQUIPMENTS OR SYSTEMS THAT REQUIRE EXTRAORDINARILY HIGH LEVELS OF QUALITY AND/OR RELIABILITY, AND/OR A MALFUNCTION OR FAILURE OF WHICH MAY CAUSE LOSS OF HUMAN LIFE, BODILY INJURY, SERIOUS PROPERTY DAMAGE AND/OR SERIOUS PUBLIC IMPACT ("UNINTENDED USE"). Except for specific applications as expressly stated in this document, Unintended Use includes, without limitation, equipment used in nuclear facilities, equipment used in the aerospace industry, Class 3 medical devices, equipment used for automobiles, and military vehicles and munitions. IF YOU USE PRODUCT FOR UNINTENDED USE, TOSHIBA ASSUMES NO LIABILITY FOR PRODUCT. For details, please contact your TOSHIBA sales representative or contact us via our website.
- Do not disassemble, analyze, reverse-engineer, alter, modify, translate or copy Product, whether in whole or in part.
- Product shall not be used for or incorporated into any products or systems whose manufacture, use, or sale is prohibited under any applicable laws or regulations.
- The information contained herein is presented only as guidance for Product use. No responsibility is assumed by TOSHIBA for any infringement of patents or any other intellectual property rights of third parties that may result from the use of Product. No license to any intellectual property right is granted by this document, whether express or implied, by estoppel or otherwise.
- ABSENT A WRITTEN SIGNED AGREEMENT, EXCEPT AS PROVIDED IN THE RELEVANT TERMS AND CONDITIONS OF SALE FOR PRODUCT, AND TO THE MAXIMUM EXTENT ALLOWABLE BY LAW, TOSHIBA (1) ASSUMES NO LIABILITY WHATSOEVER, INCLUDING WITHOUT LIMITATION, INDIRECT, CONSEQUENTIAL, SPECIAL, OR INCIDENTAL DAMAGES OR LOSS, INCLUDING WITHOUT LIMITATION, LOSS OF PROFITS, LOSS OF OPPORTUNITIES, BUSINESS INTERRUPTION AND LOSS OF DATA, AND (2) DISCLAIMS ANY AND ALL EXPRESS OR IMPLIED WARRANTIES AND CONDITIONS RELATED TO SALE, USE OF PRODUCT, OR INFORMATION, INCLUDING WARRANTIES OR CONDITIONS OF MERCHANTABILITY, FITNESS FOR A PARTICULAR PURPOSE, ACCURACY OF INFORMATION, OR NONINFRINGEMENT.
- Do not use or otherwise make available Product or related software or technology for any military purposes, including without limitation, for the design, development, use, stockpiling or manufacturing of nuclear, chemical, or biological weapons or missile technology products (mass destruction weapons). Product and related software and technology may be controlled under the applicable export laws and regulations including, without limitation, the Japanese Foreign Exchange and Foreign Trade Law and the U.S. Export Administration Regulations. Export and re-export of Product or related software or technology are strictly prohibited except in compliance with all applicable export laws and regulations.
- Please contact your TOSHIBA sales representative for details as to environmental matters such as the RoHS compatibility of Product. Please use Product in compliance with all applicable laws and regulations that regulate the inclusion or use of controlled substances, including without limitation, the EU RoHS Directive. TOSHIBA ASSUMES NO LIABILITY FOR DAMAGES OR LOSSES OCCURRING AS A RESULT OF NONCOMPLIANCE WITH APPLICABLE LAWS AND REGULATIONS.