

## Introduction to Toshiba Bias Resistor Built-in Transistors (Digital Transistors)

Toshiba has a lineup of transistors with built-in resistors (BRT: Bias Resistor Built-in Transistors) that combine various resistance values with NPN / PNP transistors (BJT: Bipolar junction transistors) in a small package.

### Toshiba, a leading company in transistors

Since Toshiba succeeded in developing a transistor in 1951, it has been one of the major transistor vendors [Note] who have continued to market products as a pioneer in the industry since the early days of semiconductors. We will continue to provide a wide range of highly reliable transistor products based on our experience in delivering products to many customers.

[Note] according to a survey by Toshiba (as of March 1<sup>st</sup>, 2021)



### High-quality, safe and secure delivery at plants in Japan and Thailand

Our transistor products are mainly surface-mount type small packages. High-quality, stable production at plants in Japan and Thailand enables safe and safety delivery. We will respond quickly and seriously to sudden delivery problems as well.

### Bias Resistor Built-in Transistors (Digital Transistors) overview

It is a transistor with a resistor added between the base, base - emitter of the bipolar transistor. For this reason, the circuit configuration easier with fewer external components such as bias resistors. The main use is for switching. The following is an example of adding a resistor to the NPN transistor / PNP transistor.

#### NPN Transistor

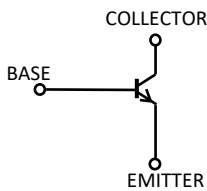

Add a resistor to the base terminal (input resistor)



Base terminal and base-emitter terminal Add resistance between

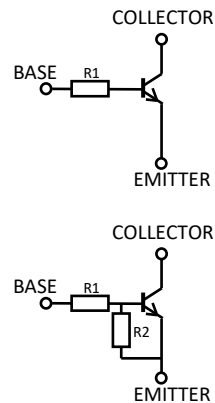

#### PNP Transistor

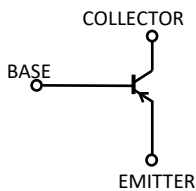

Add a resistor to the base terminal (input resistor)

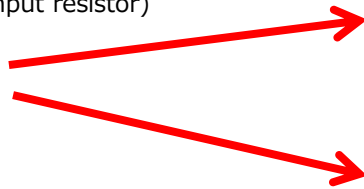

Base terminal and base-emitter terminal Add resistance between

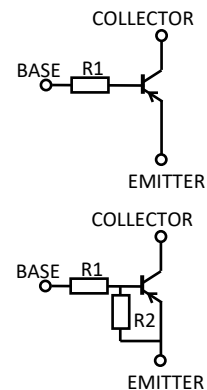

## Bias Resistor Built-in Transistors (Digital Transistors) Selection guide

As shown in the figure below, we have a lineup, including 1in1 and 2in1 transistors with built-in resistors for NPN transistors and PNP transistors in the package.

### Internal Connections

#### NPN type

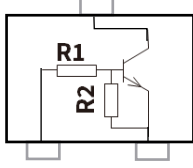
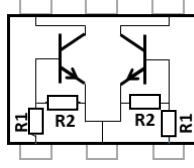
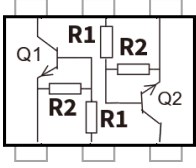
1in1	2in1	
NPN x 1	Common emitter NPN x 2	Point-symmetrical NPN x 2
		

#### PNP type

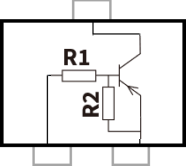
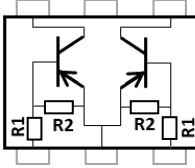
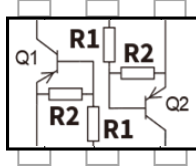



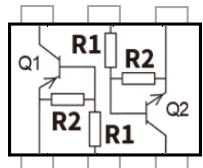
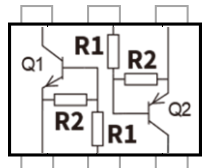

1in1	2in1	
PNP x 1	Common emitter NPN x 2	Point-symmetrical NPN x 2
		



#### NPN+PNP type

2in1	
Point-symmetrical PNP+NPN	Point-symmetrical NPN+PNP
	

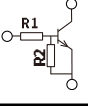
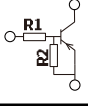
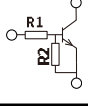
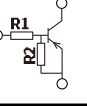
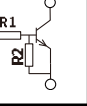
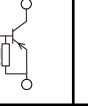
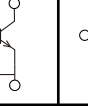
## • Bias Resistor Built-in Transistors (Digital Transistors) selection table

[Single product]

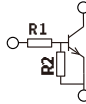
V <sub>CE0</sub>   (V)	I <sub>C</sub>   (mA)	Resistance		VESM (SOT-723)  1.2x1.2		SSM (SOT-416)  1.6x1.6		USM (SOT-323)  2.0x2.1		S-Mini (SOT-346)  2.9x2.5	
		R1 (typ.)	R2 (typ.)								
		(kΩ)	(kΩ)	NPN	PNP	NPN	PNP	NPN	PNP	NPN	PNP
		Part Number									
50	100	4.7	4.7	<a href="#">RN1101MFV</a>	<a href="#">RN2101MFV</a>	<a href="#">RN1101</a>	<a href="#">RN2101</a>	<a href="#">RN1301</a>	<a href="#">RN2301</a>	<a href="#">RN1401</a>	<a href="#">RN2401</a>
		10	10	<a href="#">RN1102MFV</a>	<a href="#">RN2102MFV</a>	<a href="#">RN1102</a>	<a href="#">RN2102</a>	<a href="#">RN1302</a>	<a href="#">RN2302</a>	<a href="#">RN1402</a>	<a href="#">RN2402</a>
		22	22	<a href="#">RN1103MFV</a>	<a href="#">RN2103MFV</a>	<a href="#">RN1103</a>	<a href="#">RN2103</a>	<a href="#">RN1303</a>	<a href="#">RN2303</a>	<a href="#">RN1403</a>	<a href="#">RN2403</a>
		47	47	<a href="#">RN1104MFV</a>	<a href="#">RN2104MFV</a>	<a href="#">RN1104</a>	<a href="#">RN2104</a>	<a href="#">RN1304</a>	<a href="#">RN2304</a>	<a href="#">RN1404</a>	<a href="#">RN2404</a>
		2.2	47	<a href="#">RN1105MFV</a>	<a href="#">RN2105MFV</a>	<a href="#">RN1105</a>	<a href="#">RN2105</a>	<a href="#">RN1305</a>	<a href="#">RN2305</a>	<a href="#">RN1405</a>	<a href="#">RN2405</a>
		4.7	47	<a href="#">RN1106MFV</a>	<a href="#">RN2106MFV</a>	<a href="#">RN1106</a>	<a href="#">RN2106</a>	<a href="#">RN1306</a>	<a href="#">RN2306</a>	<a href="#">RN1406</a>	<a href="#">RN2406</a>
		10	47	<a href="#">RN1107MFV</a>	<a href="#">RN2107MFV</a>	<a href="#">RN1107</a>	<a href="#">RN2107</a>	<a href="#">RN1307</a>	<a href="#">RN2307</a>	<a href="#">RN1407</a>	<a href="#">RN2407</a>
		22	47	<a href="#">RN1108MFV</a>	<a href="#">RN2108MFV</a>	<a href="#">RN1108</a>	<a href="#">RN2108</a>	<a href="#">RN1308</a>	<a href="#">RN2308</a>	<a href="#">RN1408</a>	<a href="#">RN2408</a>
		47	22	<a href="#">RN1109MFV</a>	<a href="#">RN2109MFV</a>	<a href="#">RN1109</a>	<a href="#">RN2109</a>	<a href="#">RN1309</a>	<a href="#">RN2309</a>	<a href="#">RN1409</a>	<a href="#">RN2409</a>
		4.7	-	<a href="#">RN1110MFV</a>	<a href="#">RN2110MFV</a>	<a href="#">RN1110</a>	<a href="#">RN2110</a>	<a href="#">RN1310</a>	<a href="#">RN2310</a>	<a href="#">RN1410</a>	<a href="#">RN2410</a>
		10	-	<a href="#">RN1111MFV</a>	<a href="#">RN2111MFV</a>	<a href="#">RN1111</a>	<a href="#">RN2111</a>	<a href="#">RN1311</a>	<a href="#">RN2311</a>	<a href="#">RN1411</a>	<a href="#">RN2411</a>
		22	-	<a href="#">RN1112MFV</a>	<a href="#">RN2112MFV</a>	<a href="#">RN1112</a>	<a href="#">RN2112</a>	<a href="#">RN1312</a>	<a href="#">RN2312</a>	<a href="#">RN1412</a>	<a href="#">RN2412</a>
		47	-	<a href="#">RN1113MFV</a>	<a href="#">RN2113MFV</a>	<a href="#">RN1113</a>	<a href="#">RN2113</a>	<a href="#">RN1313</a>	<a href="#">RN2313</a>	<a href="#">RN1413</a>	<a href="#">RN2413</a>
		1	10	<a href="#">RN1114MFV</a>	<a href="#">RN2114MFV</a>	<a href="#">RN1114</a>	<a href="#">RN2114</a>	<a href="#">RN1314</a>	-	<a href="#">RN1414</a>	<a href="#">RN2414</a>
		2.2	10	<a href="#">RN1115MFV</a>	<a href="#">RN2115MFV</a>	<a href="#">RN1115</a>	<a href="#">RN2115</a>	<a href="#">RN1315</a>	<a href="#">RN2315</a>	<a href="#">RN1415</a>	<a href="#">RN2415</a>
		4.7	10	<a href="#">RN1116MFV</a>	<a href="#">RN2116MFV</a>	<a href="#">RN1116</a>	<a href="#">RN2116</a>	<a href="#">RN1316</a>	<a href="#">RN2316</a>	<a href="#">RN1416</a>	<a href="#">RN2416</a>
		10	4.7	<a href="#">RN1117MFV</a>	<a href="#">RN2117MFV</a>	<a href="#">RN1117</a>	<a href="#">RN2117</a>	<a href="#">RN1317</a>	<a href="#">RN2317</a>	<a href="#">RN1417</a>	<a href="#">RN2417</a>
		47	10	<a href="#">RN1118MFV</a>	-	<a href="#">RN1118</a>	-	<a href="#">RN1318</a>	<a href="#">RN2318</a>	<a href="#">RN1418</a>	<a href="#">RN2418</a>
		1	-	<a href="#">RN1119MFV</a>	<a href="#">RN2119MFV</a>	-	-	-	-	-	-
		100	100	<a href="#">RN1130MFV</a>	<a href="#">RN2130MFV</a>	-	-	-	-	-	-
100	-	<a href="#">RN1131MFV</a>	<a href="#">RN2131MFV</a>	-	-	-	-	-	-		
200	-	<a href="#">RN1132MFV</a>	<a href="#">RN2132MFV</a>	-	-	-	-	-	-		

V <sub>CE0</sub>   (V)	I <sub>C</sub>   (mA)	Resistance		SOT23 (SOT-23)  2.9x2.4	
		R1 (typ.)	R2 (typ.)		
		(kΩ)	(kΩ)	NPN	PNP
		Part Number			
50	100	4.7	4.7	<a href="#">TDTC143E</a>	<a href="#">TDTA143E</a>
		10	10	<a href="#">TDTC114E</a>	<a href="#">TDTA114E</a>
		22	22	<a href="#">TDTC124E</a>	<a href="#">TDTA124E</a>
		47	47	<a href="#">TDTC144E</a>	<a href="#">TDTA144E</a>
		2.2	47	<a href="#">TDTC123J</a>	<a href="#">TDTA123J</a>
		4.7	47	<a href="#">TDTC143Z</a>	<a href="#">TDTA143Z</a>
		10	47	<a href="#">TDTC114Y</a>	<a href="#">TDTA114Y</a>

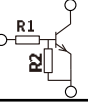
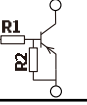
V <sub>CE0</sub>   (V)	I <sub>C</sub>   (mA)	Resistance		S-Mini (SOT-346)  2.9x2.5	
		R1 (typ.)	R2 (typ.)		
		(kΩ)	(kΩ)	NPN	PNP
		Part Number			
50	800	1	1	<a href="#">RN1421</a>	<a href="#">RN2421</a>
		2.2	2.2	<a href="#">RN1422</a>	<a href="#">RN2422</a>
		4.7	4.7	<a href="#">RN1423</a>	<a href="#">RN2423</a>
		10	10	<a href="#">RN1424</a>	<a href="#">RN2424</a>
		0.47	10	<a href="#">RN1425</a>	<a href="#">RN2425</a>
		1	10	<a href="#">RN1426</a>	<a href="#">RN2426</a>
		2.2	10	<a href="#">RN1427</a>	<a href="#">RN2427</a>

• Bias Resistor Built-in Transistors (Digital Transistors) selection table

[2in1 product]

• Common emitter

V <sub>CE0</sub>   (V)	I <sub>C</sub>   (mA)	Resistance		ESV (SOT-553) 1.6x1.6		USV (SOT-353) 2.0x2.1		SMV (SOT-25) 2.9x2.8	
		R1 (typ.)	R2 (typ.)						
		(kΩ)	(kΩ)	NPNx2	PNPx2	NPNx2	PNPx2	NPNx2	PNPx2
		Part Number							
50	100	4.7	4.7	<a href="#">RN1701JE</a>	<a href="#">RN2701JE</a>	<a href="#">RN1701</a>	<a href="#">RN2701</a>	<a href="#">RN1501</a>	<a href="#">RN2501</a>
		10	10	<a href="#">RN1702JE</a>	<a href="#">RN2702JE</a>	<a href="#">RN1702</a>	<a href="#">RN2702</a>	<a href="#">RN1502</a>	<a href="#">RN2502</a>
		22	22	<a href="#">RN1703JE</a>	<a href="#">RN2703JE</a>	<a href="#">RN1703</a>	<a href="#">RN2703</a>	<a href="#">RN1503</a>	<a href="#">RN2503</a>
		47	47	<a href="#">RN1704JE</a>	<a href="#">RN2704JE</a>	<a href="#">RN1704</a>	<a href="#">RN2704</a>	<a href="#">RN1504</a>	<a href="#">RN2504</a>
		2.2	47	<a href="#">RN1705JE</a>	<a href="#">RN2705JE</a>	<a href="#">RN1705</a>	<a href="#">RN2705</a>	<a href="#">RN1505</a>	<a href="#">RN2505</a>
		4.7	47	<a href="#">RN1706JE</a>	<a href="#">RN2706JE</a>	<a href="#">RN1706</a>	<a href="#">RN2706</a>	<a href="#">RN1506</a>	<a href="#">RN2506</a>
		10	47	<a href="#">RN1707JE</a>	<a href="#">RN2707JE</a>	<a href="#">RN1707</a>	<a href="#">RN2707</a>	<a href="#">RN1507</a>	<a href="#">RN2507</a>
		22	47	<a href="#">RN1708JE</a>	<a href="#">RN2708JE</a>	<a href="#">RN1708</a>	<a href="#">RN2708</a>	<a href="#">RN1508</a>	-
		47	22	<a href="#">RN1709JE</a>	<a href="#">RN2709JE</a>	<a href="#">RN1709</a>	<a href="#">RN2709</a>	<a href="#">RN1509</a>	-
		4.7	-	<a href="#">RN1710JE</a>	<a href="#">RN2710JE</a>	<a href="#">RN1710</a>	<a href="#">RN2710</a>	<a href="#">RN1510</a>	<a href="#">RN2510</a>
		10	-	<a href="#">RN1711JE</a>	<a href="#">RN2711JE</a>	<a href="#">RN1711</a>	<a href="#">RN2711</a>	<a href="#">RN1511</a>	<a href="#">RN2511</a>
		22	-	-	<a href="#">RN2712JE</a>	-	-	-	-
		47	-	-	<a href="#">RN2713JE</a>	-	-	-	-













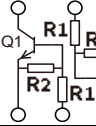
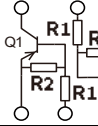
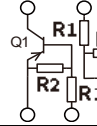



































• Point-symmetrical













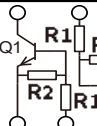
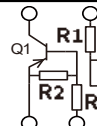
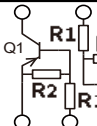





















V <sub>CE0</sub>   (V)	I <sub>C</sub>   (mA)	Resistance		ES6 (SOT-563) 1.6x1.6			
		R1 (typ.)	R2 (typ.)				
		(kΩ)	(kΩ)	NPNx2	PNPx2	PNP+NPN	NPN+PNP
		Part Number					
50	100	4.7	4.7	<a href="#">RN1901FE</a>	<a href="#">RN2901FE</a>	<a href="#">RN4901FE</a>	<a href="#">RN4981FE</a>
		10	10	<a href="#">RN1902FE</a>	<a href="#">RN2902FE</a>	<a href="#">RN4902FE</a>	<a href="#">RN4982FE</a>
		22	22	<a href="#">RN1903FE</a>	<a href="#">RN2903FE</a>	<a href="#">RN4903FE</a>	<a href="#">RN4983FE</a>
		47	47	<a href="#">RN1904FE</a>	<a href="#">RN2904FE</a>	<a href="#">RN4904FE</a>	<a href="#">RN4984FE</a>
		2.2	47	<a href="#">RN1905FE</a>	<a href="#">RN2905FE</a>	<a href="#">RN4905FE</a>	<a href="#">RN4985FE</a>
		4.7	47	<a href="#">RN1906FE</a>	<a href="#">RN2906FE</a>	<a href="#">RN4906FE</a>	<a href="#">RN4986FE</a>
		10	47	<a href="#">RN1907FE</a>	<a href="#">RN2907FE</a>	<a href="#">RN4907FE</a>	<a href="#">RN4987FE</a>
		22	47	<a href="#">RN1908FE</a>	<a href="#">RN2908FE</a>	<a href="#">RN4908FE</a>	<a href="#">RN4988FE</a>
		47	22	<a href="#">RN1909FE</a>	<a href="#">RN2909FE</a>	<a href="#">RN4909FE</a>	<a href="#">RN4989FE</a>
		4.7	-	<a href="#">RN1910FE</a>	<a href="#">RN2910FE</a>	<a href="#">RN4910FE</a>	<a href="#">RN4990FE</a>
		10	-	<a href="#">RN1911FE</a>	<a href="#">RN2911FE</a>	<a href="#">RN4911FE</a>	<a href="#">RN4991FE</a>

•Bias Resistor Built-in Transistors (Digital Transistors) selection table

[2in1 product]

•Point-symmetrical

V <sub>CE0</sub>   (V)	I <sub>C</sub>   (mA)	Resistance		<div style="text-align: center;">  <p><b>US6</b> (SOT-363)</p>  <p>2.0x2.1</p> </div>			
		R1 (typ.)	R2 (typ.)				
		(kΩ)	(kΩ)	Part Number			
50	100	4.7	4.7	<a href="#">RN1901</a> 	<a href="#">RN2901</a> 	<a href="#">RN4901</a> 	<a href="#">RN4981</a> 
		10	10	<a href="#">RN1902</a> 	<a href="#">RN2902</a> 	<a href="#">RN4902</a> 	<a href="#">RN4982</a> 
		22	22	<a href="#">RN1903</a> 	<a href="#">RN2903</a> 	<a href="#">RN4903</a> 	<a href="#">RN4983</a> 
		47	47	<a href="#">RN1904</a> 	<a href="#">RN2904</a> 	<a href="#">RN4904</a> 	<a href="#">RN4984</a> 
		2.2	47	<a href="#">RN1905</a> 	<a href="#">RN2905</a> 	<a href="#">RN4905</a> 	<a href="#">RN4985</a> 
		4.7	47	<a href="#">RN1906</a> 	<a href="#">RN2906</a> 	<a href="#">RN4906</a> 	<a href="#">RN4986</a> 
		10	47	<a href="#">RN1907</a> 	<a href="#">RN2907</a> 	<a href="#">RN4907</a> 	<a href="#">RN4987</a> 
		22	47	<a href="#">RN1908</a> 	<a href="#">RN2908</a> 	<a href="#">RN4908</a> 	<a href="#">RN4988</a> 
		47	22	<a href="#">RN1909</a> 	<a href="#">RN2909</a> 	<a href="#">RN4909</a> 	<a href="#">RN4989</a> 
		4.7	-	<a href="#">RN1910</a> 	<a href="#">RN2910</a> 	<a href="#">RN4910</a> 	<a href="#">RN4990</a> 
		10	-	<a href="#">RN1911</a> 	<a href="#">RN2911</a> 	<a href="#">RN4911</a> 	-
47/2.2	47/47	-	-	-	<a href="#">RN49A2</a> 		

V <sub>CE0</sub>   (V)	I <sub>C</sub>   (mA)	Resistance		<div style="text-align: center;">  <p><b>SM6</b> (SOT-26)</p>  <p>2.9x2.8</p> </div>		
		R1 (typ.)	R2 (typ.)			
		(kΩ)	(kΩ)	Part Number		
50	100	4.7	4.7	<a href="#">RN1601</a> 	<a href="#">RN2601</a> 	<a href="#">RN4601</a> 
		10	10	<a href="#">RN1602</a> 	<a href="#">RN2602</a> 	<a href="#">RN4602</a> 
		22	22	<a href="#">RN1603</a> 	<a href="#">RN2603</a> 	<a href="#">RN4603</a> 
		47	47	<a href="#">RN1604</a> 	<a href="#">RN2604</a> 	<a href="#">RN4604</a> 
		2.2	47	<a href="#">RN1605</a> 	<a href="#">RN2605</a> 	<a href="#">RN4605</a> 
		4.7	47	<a href="#">RN1606</a> 	<a href="#">RN2606</a> 	<a href="#">RN4606</a> 
		10	47	<a href="#">RN1607</a> 	<a href="#">RN2607</a> 	<a href="#">RN4607</a> 
		22	47	<a href="#">RN1608</a> 	<a href="#">RN2608</a> 	<a href="#">RN4608</a> 
		47	22	<a href="#">RN1609</a> 	-	<a href="#">RN4609</a> 
		4.7	∞	<a href="#">RN1610</a> 	<a href="#">RN2610</a> 	<a href="#">RN4610</a> 
		10	∞	<a href="#">RN1611</a> 	-	<a href="#">RN4611</a> 
22	∞	-	-	<a href="#">RN4612</a> 		

## LINK

- Parametric search [Click](#)
- Application Notes [Click](#)
- Frequently Asked Questions (FAQ) of BRT [Click](#)
- Stock Check & Purchase [Click](#)
- Cross Reference Search [Click](#)

\*Company names, product names, and service names may be trademarks of their respective companies.

## RESTRICTIONS ON PRODUCT USE

Toshiba Corporation and its subsidiaries and affiliates are collectively referred to as "TOSHIBA".

Hardware, software and systems described in this document are collectively referred to as "Product".

- TOSHIBA reserves the right to make changes to the information in this document and related Product without notice.
- This document and any information herein may not be reproduced without prior written permission from TOSHIBA. Even with TOSHIBA's written permission, reproduction is permissible only if reproduction is without alteration/omission.
- Though TOSHIBA works continually to improve Product's quality and reliability, Product can malfunction or fail. Customers are responsible for complying with safety standards and for providing adequate designs and safeguards for their hardware, software and systems which minimize risk and avoid situations in which a malfunction or failure of Product could cause loss of human life, bodily injury or damage to property, including data loss or corruption. Before customers use the Product, create designs including the Product, or incorporate the Product into their own applications, customers must also refer to and comply with (a) the latest versions of all relevant TOSHIBA information, including without limitation, this document, the specifications, the data sheets and application notes for Product and the precautions and conditions set forth in the "TOSHIBA Semiconductor Reliability Handbook" and (b) the instructions for the application with which the Product will be used with or for. Customers are solely responsible for all aspects of their own product design or applications, including but not limited to (a) determining the appropriateness of the use of this Product in such design or applications; (b) evaluating and determining the applicability of any information contained in this document, or in charts, diagrams, programs, algorithms, sample application circuits, or any other referenced documents; and (c) validating all operating parameters for such designs and applications. TOSHIBA ASSUMES NO LIABILITY FOR CUSTOMERS' PRODUCT DESIGN OR APPLICATIONS.
- PRODUCT IS NEITHER INTENDED NOR WARRANTED FOR USE IN EQUIPMENTS OR SYSTEMS THAT REQUIRE EXTRAORDINARILY HIGH LEVELS OF QUALITY AND/OR RELIABILITY, AND/OR A MALFUNCTION OR FAILURE OF WHICH MAY CAUSE LOSS OF HUMAN LIFE, BODILY INJURY, SERIOUS PROPERTY DAMAGE AND/OR SERIOUS PUBLIC IMPACT ("UNINTENDED USE"). Except for specific applications as expressly stated in this document, Unintended Use includes, without limitation, equipment used in nuclear facilities, equipment used in the aerospace industry, lifesaving and/or life supporting medical equipment, equipment used for automobiles, trains, ships and other transportation, traffic signaling equipment, equipment used to control combustions or explosions, safety devices, elevators and escalators, and devices related to power plant. IF YOU USE PRODUCT FOR UNINTENDED USE, TOSHIBA ASSUMES NO LIABILITY FOR PRODUCT. For details, please contact your TOSHIBA sales representative or contact us via our website.
- Do not disassemble, analyze, reverse-engineer, alter, modify, translate or copy Product, whether in whole or in part.
- Product shall not be used for or incorporated into any products or systems whose manufacture, use, or sale is prohibited under any applicable laws or regulations.
- The information contained herein is presented only as guidance for Product use. No responsibility is assumed by TOSHIBA for any infringement of patents or any other intellectual property rights of third parties that may result from the use of Product. No license to any intellectual property right is granted by this document, whether express or implied, by estoppel or otherwise.
- ABSENT A WRITTEN SIGNED AGREEMENT, EXCEPT AS PROVIDED IN THE RELEVANT TERMS AND CONDITIONS OF SALE FOR PRODUCT, AND TO THE MAXIMUM EXTENT ALLOWABLE BY LAW, TOSHIBA (1) ASSUMES NO LIABILITY WHATSOEVER, INCLUDING WITHOUT LIMITATION, INDIRECT, CONSEQUENTIAL, SPECIAL, OR INCIDENTAL DAMAGES OR LOSS, INCLUDING WITHOUT LIMITATION, LOSS OF PROFITS, LOSS OF OPPORTUNITIES, BUSINESS INTERRUPTION AND LOSS OF DATA, AND (2) DISCLAIMS ANY AND ALL EXPRESS OR IMPLIED WARRANTIES AND CONDITIONS RELATED TO SALE, USE OF PRODUCT, OR INFORMATION, INCLUDING WARRANTIES OR CONDITIONS OF MERCHANTABILITY, FITNESS FOR A PARTICULAR PURPOSE, ACCURACY OF INFORMATION, OR NONINFRINGEMENT.
- Do not use or otherwise make available Product or related software or technology for any military purposes, including without limitation, for the design, development, use, stockpiling or manufacturing of nuclear, chemical, or biological weapons or missile technology products (mass destruction weapons). Product and related software and technology may be controlled under the applicable export laws and regulations including, without limitation, the Japanese Foreign Exchange and Foreign Trade Law and the U.S. Export Administration Regulations. Export and re-export of Product or related software or technology are strictly prohibited except in compliance with all applicable export laws and regulations.
- Please contact your TOSHIBA sales representative for details as to environmental matters such as the RoHS compatibility of Product. Please use Product in compliance with all applicable laws and regulations that regulate the inclusion or use of controlled substances, including without limitation, the EU RoHS Directive. TOSHIBA ASSUMES NO LIABILITY FOR DAMAGES OR LOSSES OCCURRING AS A RESULT OF NONCOMPLIANCE WITH APPLICABLE LAWS AND REGULATIONS.