

SiC MOSFET module iXPLV Handling instruction application note

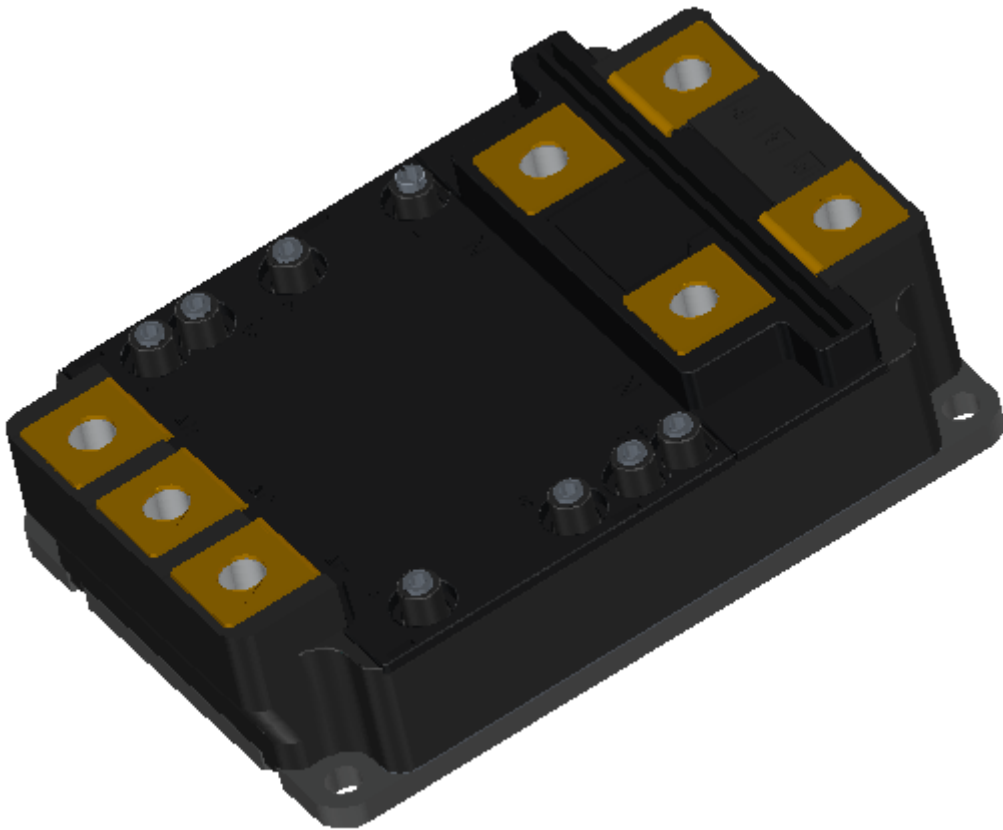

Table of contents

1. SiC MOSFET module	3
1.1. Scope.....	3
1.2. Features of SiC MOSFET Module (iXPLV).....	4
1.3. Internal circuit.....	4
1.4. Thermistor	5
1.5. Current sensing inductance.....	6
1.6. Clearance distance, creepage distance and insulation.....	6
1.7. Cosmic ray effect.....	6
2. Transportation, storage and installation	7
2.1. Transportation.....	7
2.2. Storage	7
2.3. Anti-static discharge handlings	7
2.4. Mounting on the heatsink	8
2.4.1. Arrangement of devices.....	8
2.4.2. Design of heatsink	8
2.4.3. Application of grease	9
2.4.4. Mounting devices.....	9
2.5. Mounting of main electrodes	9
2.6. Installation of Signal Circuit Wiring Components	12
RESTRICTIONS ON PRODUCT USE	14

1. SiC MOSFET module**1.1. Scope**

The scope of this application note covers the following products.

Table 1.1.1 Product covered in this application note

Part No.	Drain-source voltage rating (V_{DSS})	Drain current (I_D)	Gate-source voltage rating (V_{GSS})	Recommended gate drive voltage ($+V_{GG}/-V_{GG}$)
MG800FXF2YMS3	3300V	800A	+25V/-10V	+20V/-6V
MG800FXF1JMS3	3300V	800A	+25V/-10V	+20V/-6V
MG800FXF1ZMS3	3300V	800A	+25V/-10V	+20V/-6V

1.2. Features of SiC MOSFET Module (iXPLV)

Silicon carbide (SiC) is a semiconductor material with a high electric breakdown field, saturated electron velocity, and thermal conductivity compared to silicon (Si). Therefore, when used in semiconductor devices, they achieve higher voltage resistance, higher-speed switching, and lower ON-resistance compared to Si devices. This is expected to be a next-generation low-loss device that contributes to lower power consumption and system downsizing.

iXPLV (intelligent fleXible Package Low Voltage) is a SiC MOSFET module equipped with silicon carbide (SiC) MOSFET chips for industrial equipment. This new module meets the needs for high-efficiency, compact equipment for industrial applications such as converters and inverters for railways, and renewable energy power generation systems.

1.3. Internal circuit

iXPLV is a circuit configuration in which two devices are mounted in the package. It has a thermistor for temperature sensing and an inductance for current sensing.

The thermistor for temperature sensing is installed between terminals 6 and 8. Refer to the datasheet for the thermistor rated resistance and B-value.

The inductance for current sensing (L_{sCS}) is equipped between terminal 1 (current sensing terminal) and terminal 8 (lower arm source sensing terminal). Refer to the datasheet for the value of L_{sCS} .

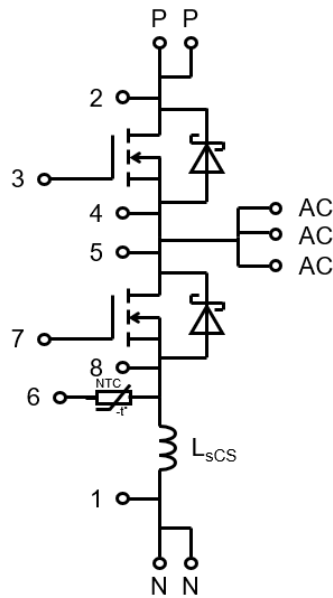

Figure 1.3.1 Internal circuit

1.4. Thermistor

The temperature of the module can be monitored by the thermistor installed in iXPLV. Thermistor temperature T can be expressed by the equation (1.4.1) where thermistor resistance value $R_{(T)}$ is calculated using the thermistor B-value and thermistor rated resistance R_{25} as described in the datasheet.

$$R_{(T)} = R_{25} \exp B \left(\frac{1}{T} - \frac{1}{298} \right) \quad \dots (1.4.1)$$

Since the thermistor is mounted at a distance from the SiC chips and the thermistor itself has a heat capacity, it is not suitable for measuring transient temperature behavior such as short-circuit detection in which the temperature rises over a short period of time.

Use the thermistor within the maximum ratings. The thermistor has a maximum rated voltage of 7.1V, a maximum rated current of 5mA (recommended current of 100 μ A), a maximum rated power of 10mW, and an operating temperature range of -40 $^{\circ}$ C to 150 $^{\circ}$ C.

Figure 1.4.2 shows an example of the circuit and output voltage and current for the thermistor.

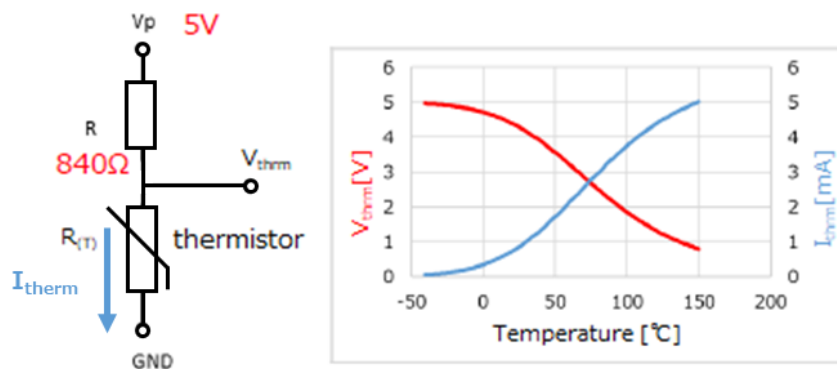

Figure 1.4.2 An example of the circuit and output voltage and current for a thermistor

1.5. Current sensing inductance

The current sensing inductance (L_{sCS}) installed in iXPLV can measure transient changes in the current through the device of the lower arm. The dI_D/dt of the current I_D of the lower arm device can be expressed by the equation (1.5.1) using the voltage V_{LS} at both ends of the current sensor terminals (between terminal 1 and terminal 8).

$$V_{LS} = -L_{sCS} \frac{dI_D}{dt} \quad \dots (1.5.1)$$

When using an inductance for current sensing, be careful not to put electrical noise on the voltage V_{LS} between terminals 1 and 8.

1.6. Clearance distance, creepage distance and insulation

The clearance distance and the creepage distance of iXPLV are designed to satisfy the values specified by IEC60664-1 applied to an altitude of 2000m or less. Since the required clearance and creepage distances increase with decreasing atmospheric pressure at altitudes of 2000m or higher. When using the product at high altitudes, design the product in accordance with the customer's insulated space distance standard and creepage distance standard design rules.

1.7. Cosmic ray effect

Similar to silicon power devices, SiC power devices may experience accidental failures due to cosmic rays.

The amount of cosmic rays is affected by latitude and altitude, and is particularly high at high altitude. In addition, cosmic ray breakdown phenomena is more likely to occur at higher operating voltages.

Please contact us if you wish to obtain an estimate of the cosmic ray accidental failure rate when using the product at high altitude or high operating voltage conditions.

2. Transportation, storage and installation

2.1. Transportation

- (1) Due to the weight of the devices, care should be taken when handling them.
- (2) The orientation and maximum number of stacked items should be in accordance with the markings on the packing boxes.
- (3) Do not subject the product to impact or drop during transportation, as this may damage the packing box and/or damage the devices.
- (4) Since water may cause malfunction while using the device, be careful not to get them wet especially when transporting in rain or snow.

2.2. Storage

- (1) It is recommended that the device be stored within normal temperature and humidity ranges (temperature: 5 to 35°C, humidity: 45 to 75%).
- (2) Avoid storing the product in an atmosphere containing corrosive gases, organic solvents, etc., or dusty places.
- (3) Cardboard is the main material for the packaging box when the device is delivered, it is not suitable for long-term storage.
- (4) If the product is to be stored for a long period (1 year or more), consider using different packaging for storage.
- (5) Condensation may form on the surface of the device if the temperature changes suddenly. Avoid this environment by storing in a place with minimum temperature fluctuation.
- (6) Store according to the instruction on the package box. Especially when the packing boxes are stacked, as an unexpected load may be applied.

2.3. Anti-static discharge handlings

The gate to source voltage has a maximum rating. Check the datasheet for the maximum ratings. If voltage exceeds this gate-source voltage, there is a risk that may cause a gate failure. Be careful not to apply a voltage between the gate and source terminals exceeding the maximum rated voltage stated in the datasheet.

If voltage is applied to the main circuit when the product is installed, while the gate circuit is faulty or the gate circuit is not operating normally (i.e., the gate is open), the device may be damaged due to the above reasons. To prevent this destruction, we recommend adding a protection circuit such as short-circuiting wire between the gate and source when the gate circuit is not powered on, and prevent the main circuit powering on unless the gate bias is negative.

SiC MOSFET gates also require care against electrostatic discharge. Follow these precautions when handling the device.

- (1) Electrostatic charges on the human body and clothing should be discharged with an antistatic wrist strap band with grounding wire, etc., before handling the device.
Work on an anti-static floor mat.
- (2) The device is individually packaged in an antistatic bag. Do not touch the terminals of the device directly when opening the bag. Hold the plastic body. After removal, short-circuit the gate and source terminals.
- (3) When connecting and fixing main electrodes, signal circuit wiring components, etc., take measures against accidental discharging of the materials used to prevent static electricity from being applied to the devices in the same manner as (1).

2.4. Mounting on the heatsink

2.4.1. Arrangement of devices

In order to obtain a sufficient heat dissipation effect without applying heat or mechanical stress to the device, make sure the following points when mounting the device to the heatsink.

When attaching the devices to a heatsink, make sure that the plastic body of the devices do not come into contact with each other. Contact may cause damage to the package. Check the datasheet for the upper limit of device dimensions.

Figure 2.4.1.1 shows good and bad examples of mounting multiple devices on a heatsink. Consider the heat generation of each module when designing the mounting position on the heatsink.

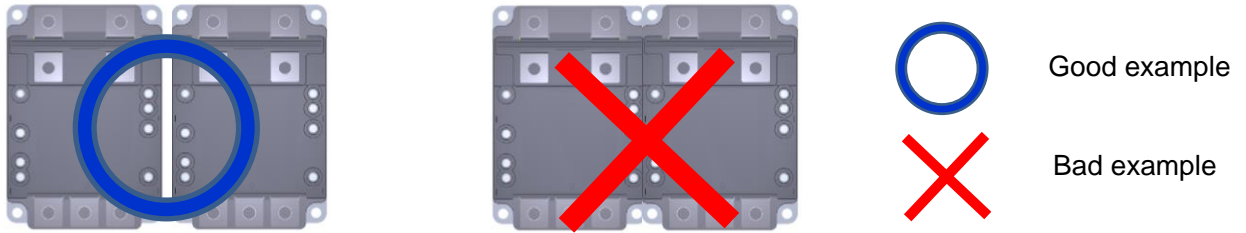

Figure 2.4.1.1 Mounting design on a heatsink

2.4.2. Design of heatsink

Select an appropriate cooling system for power dissipation of the devices.

When using air-cooled or water-cooled heatsinks, make sure that the channel temperature of the device does not exceed T_{ch} and the case temperature T_c does not exceed the operating temperature range.

As shown in Fig. 2.4.2.1, the heatsink should have a flatness of 30µm or less in the area of the base plate attached. The surface roughness should be 10µm or less.

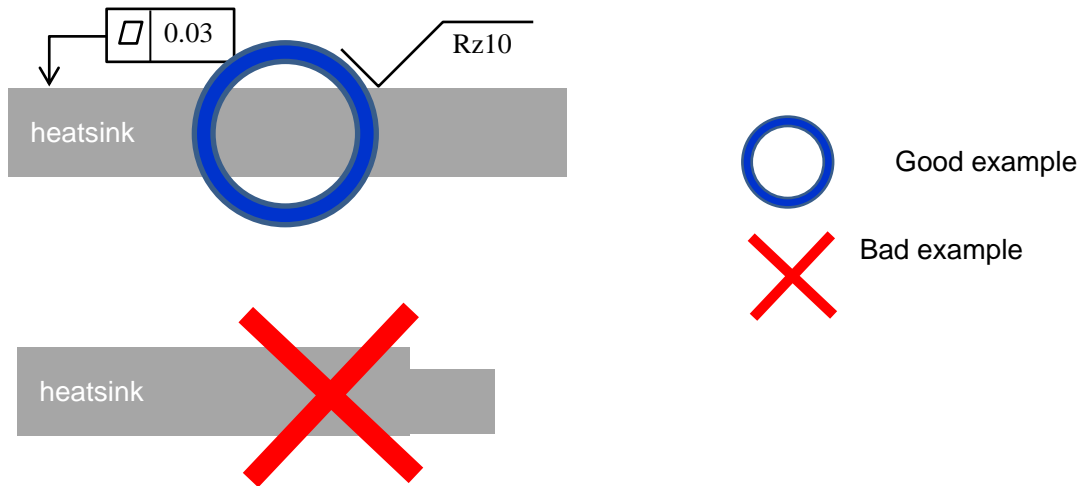

Figure 2.4.2.1 Flatness and surface roughness of heatsink

To obtain a sufficient cooling effect, mount the base plate of the device directly on the heatsink. Use the screws listed in the datasheet for mounting the device to the heatsink. To avoid unbalanced screw loads on the base plate, insert a washer between the screw and base plate, or use a flanged screw. An unbalanced screw load may cause damage.

2.4.3. Application of grease

Apply grease between the device and the heatsink to reduce thermal resistance between the device and the heatsink. Select a non-volatile, long-life grease with high thermal conductivity (which ensures the required thermal conductivity), and apply it thinly and uniformly (recommended thickness is 50µm) so that air does not enter between the base surface of the device and the heatsink.

It is important to apply a thin coat of grease to achieve sufficient heat dissipation.

Several types of grease, with different characteristics, from ease of application to difficulty of deterioration of thermal conductivity, are available. Choose the appropriate grease.

2.4.4. Mounting devices

After applying grease, mount the device to the heatsink with the recommended torque described in the datasheet in the order shown in Fig. 2.4.4.1. It is recommended when screwing to the baseplate, do so three times (20% of the recommended torque first time (engagement of screws), 60% of the recommended torque second time (prevention of single tightening of multiple screws), and 100% of the recommended torque third time (full tightening)). Tightening below the recommended torque may cause loosening during use. Unbalanced screwing or tightening above the maximum rated torque may cause damage. A manual torque screwdriver is recommended because some motorized torque drivers and air torque drivers instantaneously apply more than the recommended torque.

Clean the screws, screw holes, washer seating surface, and base seating surface.

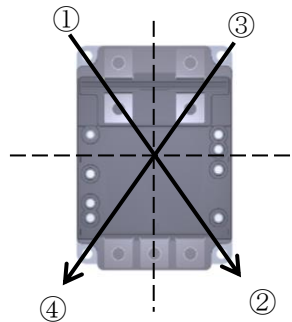

The order of screw tightening can be changed package center line (dotted) symmetrically

Examples:

②→①→④→③ is OK

③→④→①→② is OK

Fig. 2.4.4.1 Tightening sequence of screws

2.5. Mounting of main electrodes

Screw and connect the main electrodes to all terminals (2 P terminals, 2 N terminals, 3 AC terminals) as shown in Fig. 2.5.1. If there is a terminal that is not connected, it may differ from the performance described in the datasheet and may cause damage to the device.

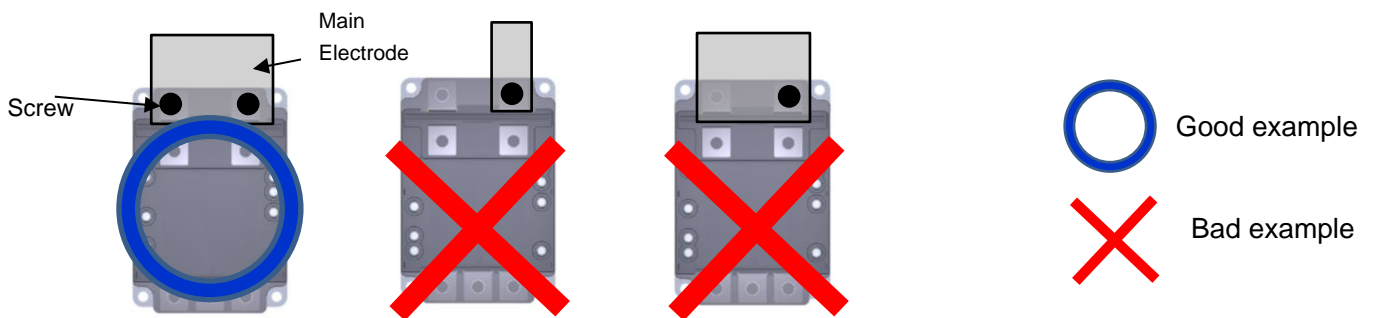

Figure 2.5.1 Connection of terminals and main electrodes (good and bad examples for P Terminals)

Design the main electrodes so that current flows equally to each terminal (2 P terminals, 2 N terminals, 3 AC terminals) as shown in Fig. 2.5.2. The symmetrical electrodes should be applied when devices are used in parallel.

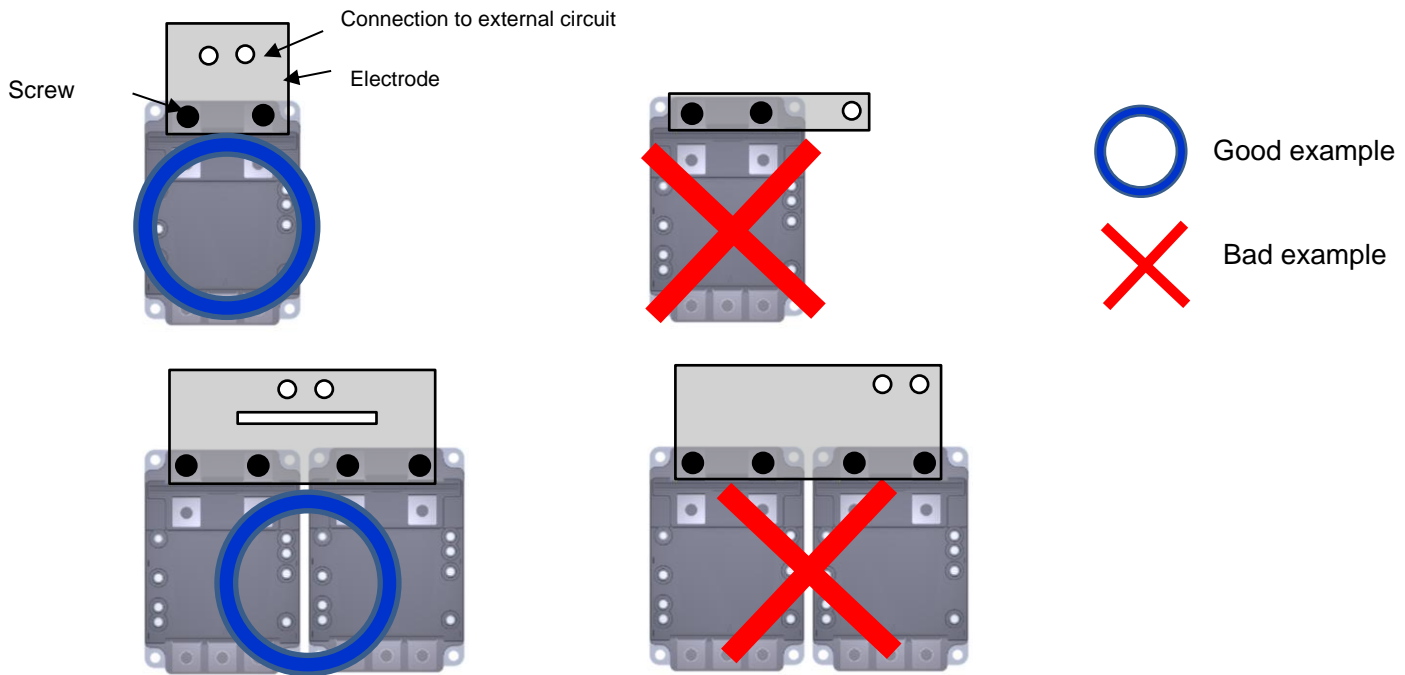

Figure 2.5.2 Examples of design of terminals and main electrodes (Good and bad examples for P Terminals)

Design the main electrodes between the N terminal and AC terminal area so that they are not covered by the main electrodes as shown in Fig. 2.5.3. Devices may be affected by electromagnetic induction from the main circuit current.

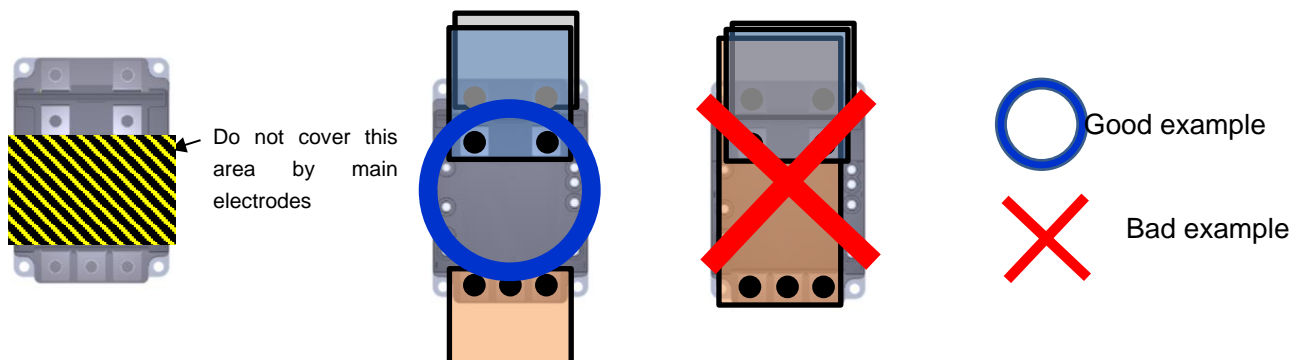

Figure 2.5.3 Design of main electrodes (good and bad examples for P, N and AC Terminals)

It is recommended that the design the electrodes are parallel and insulated for the P and N main electrodes as shown in Fig. 2.5.4. Folding the end of the insulation material into the groove between the P and N terminals is effective for ensuring the spatial insulation distance between P and N when they are displaced. (Refer to Fig. 2.5.6 for an example when the P and N main electrodes are displaced.)

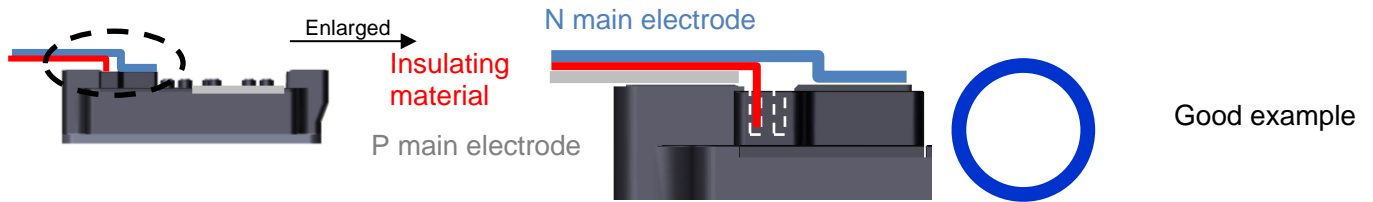

Figure 2.5.4 An example of recommended parallel electrodes and insulation for P and N main electrodes

As shown in Fig. 2.5.5, when the P and N main electrodes are spaced too far apart, the main circuit inductance is increased, so high-speed switching, which is a characteristic of SiC MOSFET, may become difficult.

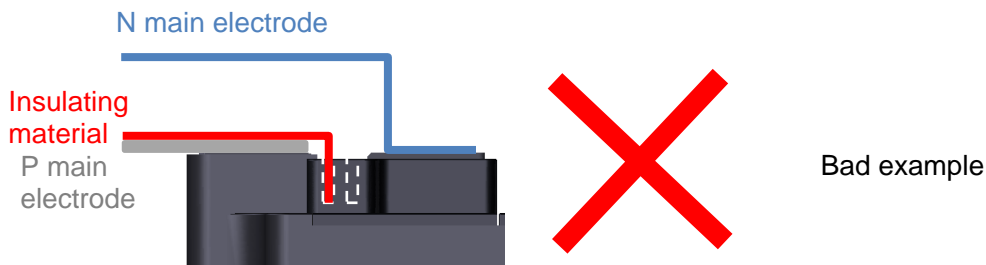

Fig. 2.5.5 An example of increase in main circuit inductance by spaced P and N main electrodes

Do not design the main electrodes so that the P-N insulation distance may be insufficient as shown in Figs. 2.5.6 and 2.5.7. Design the main electrodes to satisfy the spatial distance specified by the customer.



Fig. 2.5.6 An example of insufficient insulation distance between P and N terminals, in the case that the P main electrode moves toward the N main electrode

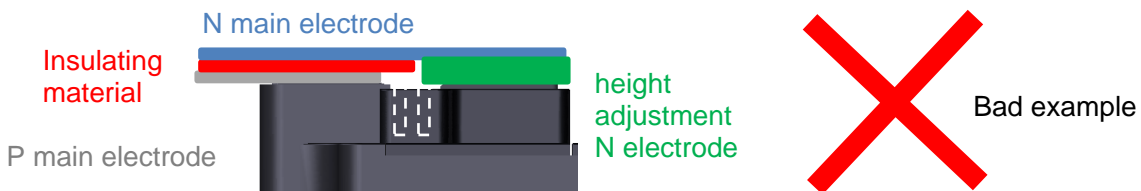

Fig. 2.5.7 An example of insufficient insulation distance between the P and N terminals with height adjustment N electrode
(This figure shows an example of the N electrode, the same applies to the P electrode)

After tightening the main electrodes and terminals (P, N, and AC terminals), it is recommended that the main electrodes be designed so that a pressing load is applied towards the base plate direction of the terminal.

When mounting the main electrodes to the device, make sure that a load exceeding Fig. 2.5.8 is not applied to the terminal. This load is the maximum allowable value only when mounting the main electrodes.

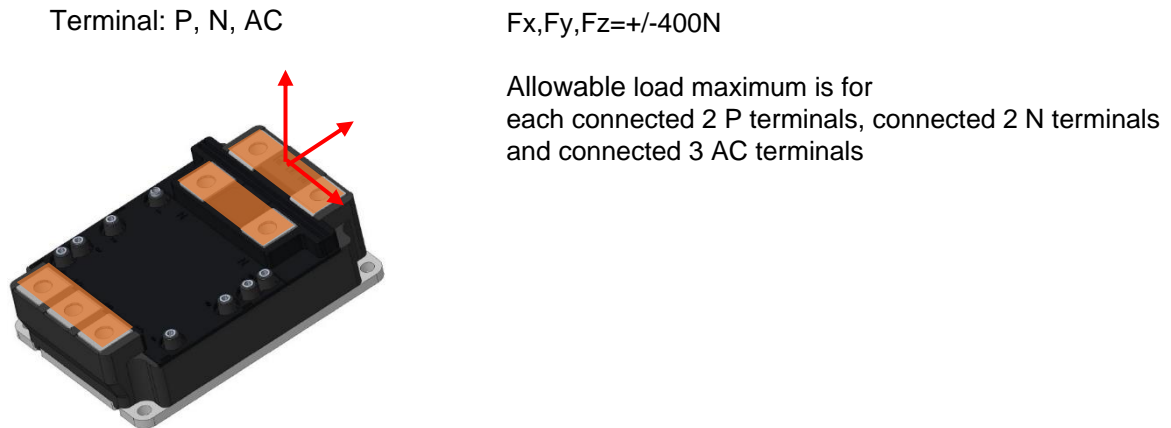

Fig. 2.5.8 Maximum allowable load when mounting main electrodes for P, N, and AC terminals

2.6. Installation of Signal Circuit Wiring Components

Design the signal circuit wiring components so that they are not affected by external electromagnetic induction.

Design the signal circuit wiring components so that there are no electrically floating terminals.

Example: When a thermistor is not used, pin 6 should have the same electrical potential as pin 8.

After tightening the signal circuit wiring components and terminals (terminals 1 to 8), it is recommended that the signal circuit wiring components be designed so that the load is applied by pressing it toward the base plate of the terminal.

When mounting the signal circuit wiring components to the device, make sure that a load exceeding Fig. 2.6.1 is not applied to the terminal. This load is the maximum allowable value only once when mounting the wire components.

Tighten the device terminals and wiring components with the screws to the recommended torque described in the datasheet. It is recommended when screwing to the baseplate, do so three times (20% of the recommended torque for the first time (engagement of screws), 60% of the recommended torque for the second time (prevention of single tightening of multiple screws), and 100% of the recommended torque for the third time (full tightening)). In doing so, do not apply a load in the direction of twisting the terminals. Use of a manual torque screwdriver is recommended because some motorized torque drivers and air torque drivers instantaneously apply more than the recommended set torque.

Clean the surfaces of the wiring components that come into contact with the screws, screw holes, and terminals.

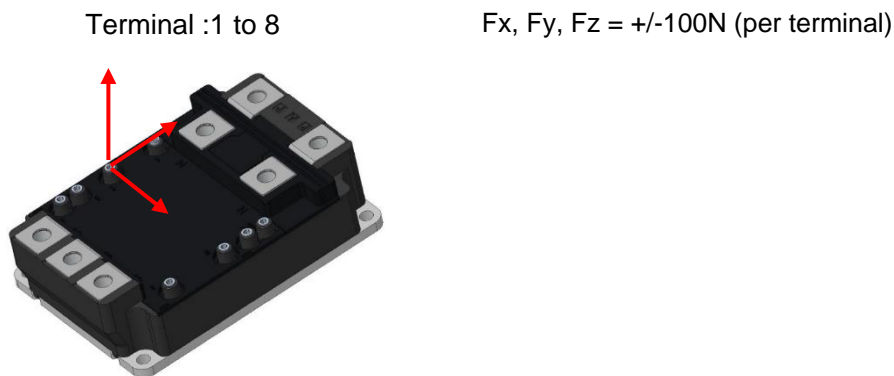

Fig. 2.6.1 Maximum allowable load when mounting signal circuit wiring components to terminals 1 to 8

Select the mounting screws that will not exceed the maximum length from the top surface of the terminals described in Table 2.6.2. Using screws longer than this may damage the device.

Table 2.6.2 Length of the mounting screws from the top surface of the terminals (maximum length and recommended minimum length)

Terminal name	Maximum length of mounting screw from top of the terminals	Recommended minimum length of mounting screw from top of the terminals
P,N,AC	16mm	10mm
1 to 8	7mm	3mm

RESTRICTIONS ON PRODUCT USE

Toshiba Corporation and its subsidiaries and affiliates are collectively referred to as "TOSHIBA". Hardware, software and systems described in this document are collectively referred to as "Product".

- TOSHIBA reserves the right to make changes to the information in this document and related Product without notice.
- This document and any information herein may not be reproduced without prior written permission from TOSHIBA. Even with TOSHIBA's written permission, reproduction is permissible only if reproduction is without alteration/omission.
- Though TOSHIBA works continually to improve Product's quality and reliability, Product can malfunction or fail. Customers are responsible for complying with safety standards and for providing adequate designs and safeguards for their hardware, software and systems which minimize risk and avoid situations in which a malfunction or failure of Product could cause loss of human life, bodily injury or damage to property, including data loss or corruption. Before customers use the Product, create designs including the Product, or incorporate the Product into their own applications, customers must also refer to and comply with (a) the latest versions of all relevant TOSHIBA information, including without limitation, this document, the specifications, the data sheets and application notes for Product and the precautions and conditions set forth in the "TOSHIBA Semiconductor Reliability Handbook" and (b) the instructions for the application with which the Product will be used with or for. Customers are solely responsible for all aspects of their own product design or applications, including but not limited to (a) determining the appropriateness of the use of this Product in such design or applications; (b) evaluating and determining the applicability of any information contained in this document, or in charts, diagrams, programs, algorithms, sample application circuits, or any other referenced documents; and (c) validating all operating parameters for such designs and applications. **TOSHIBA ASSUMES NO LIABILITY FOR CUSTOMERS' PRODUCT DESIGN OR APPLICATIONS.**
- **PRODUCT IS NEITHER INTENDED NOR WARRANTED FOR USE IN EQUIPMENTS OR SYSTEMS THAT REQUIRE EXTRAORDINARILY HIGH LEVELS OF QUALITY AND/OR RELIABILITY, AND/OR A MALFUNCTION OR FAILURE OF WHICH MAY CAUSE LOSS OF HUMAN LIFE, BODILY INJURY, SERIOUS PROPERTY DAMAGE AND/OR SERIOUS PUBLIC IMPACT ("UNINTENDED USE").** Except for specific applications as expressly stated in this document, Unintended Use includes, without limitation, equipment used in nuclear facilities, equipment used in the aerospace industry, lifesaving and/or life supporting medical equipment, equipment used for automobiles, trains, ships and other transportation, traffic signaling equipment, equipment used to control combustions or explosions, safety devices, elevators and escalators, and devices related to power plant. **IF YOU USE PRODUCT FOR UNINTENDED USE, TOSHIBA ASSUMES NO LIABILITY FOR PRODUCT.** For details, please contact your TOSHIBA sales representative or contact us via our website.
- Do not disassemble, analyze, reverse-engineer, alter, modify, translate or copy Product, whether in whole or in part.
- Product shall not be used for or incorporated into any products or systems whose manufacture, use, or sale is prohibited under any applicable laws or regulations.
- The information contained herein is presented only as guidance for Product use. No responsibility is assumed by TOSHIBA for any infringement of patents or any other intellectual property rights of third parties that may result from the use of Product. No license to any intellectual property right is granted by this document, whether express or implied, by estoppel or otherwise.
- **ABSENT A WRITTEN SIGNED AGREEMENT, EXCEPT AS PROVIDED IN THE RELEVANT TERMS AND CONDITIONS OF SALE FOR PRODUCT, AND TO THE MAXIMUM EXTENT ALLOWABLE BY LAW, TOSHIBA (1) ASSUMES NO LIABILITY WHATSOEVER, INCLUDING WITHOUT LIMITATION, INDIRECT, CONSEQUENTIAL, SPECIAL, OR INCIDENTAL DAMAGES OR LOSS, INCLUDING WITHOUT LIMITATION, LOSS OF PROFITS, LOSS OF OPPORTUNITIES, BUSINESS INTERRUPTION AND LOSS OF DATA, AND (2) DISCLAIMS ANY AND ALL EXPRESS OR IMPLIED WARRANTIES AND CONDITIONS RELATED TO SALE, USE OF PRODUCT, OR INFORMATION, INCLUDING WARRANTIES OR CONDITIONS OF MERCHANTABILITY, FITNESS FOR A PARTICULAR PURPOSE, ACCURACY OF INFORMATION, OR NONINFRINGEMENT.**
- Do not use or otherwise make available Product or related software or technology for any military purposes, including without limitation, for the design, development, use, stockpiling or manufacturing of nuclear, chemical, or biological weapons or missile technology products (mass destruction weapons). Product and related software and technology may be controlled under the applicable export laws and regulations including, without limitation, the Japanese Foreign Exchange and Foreign Trade Law and the U.S. Export Administration Regulations. Export and re-export of Product or related software or technology are strictly prohibited except in compliance with all applicable export laws and regulations.
- Please contact your TOSHIBA sales representative for details as to environmental matters such as the RoHS compatibility of Product. Please use Product in compliance with all applicable laws and regulations that regulate the inclusion or use of controlled substances, including without limitation, the EU RoHS Directive. **TOSHIBA ASSUMES NO LIABILITY FOR DAMAGES OR LOSSES OCCURRING AS A RESULT OF NONCOMPLIANCE WITH APPLICABLE LAWS AND REGULATIONS.**

Toshiba Electronic Devices & Storage Corporation

<https://toshiba.semicon-storage.com/>